



Wireless Low Temperature Sensors

General Description

The ALTA Wireless Low Temperature Sensor uses a glass coated platinum RTD sensor to accurately measure temperatures from -200°C to +162°C (-328°F to +325°F).

- Standard accuracy at 0°C: +/- 3.3°C
- Calibrated accuracy at 0°C: +/- 0.5°C
- Temperature range: -200°C to +162°C (-328°F to +325°F)

Principle of Operation

The ALTA Wireless Low Temperature Sensor outputs the ambient temperature in degrees Celsius or Fahrenheit. It is programmed to sleep for a user-given time interval (heartbeat) and then wakeup, power up the RTD sensor and wait for it to stabilize then mathematically compute the temperature and transmit the data to the gateway.

Example Applications

- Freezers & Coolers
- Environmental Monitoring
- Smart Machines & Smart Structures
- HVAC Operation & Testing
- And many more...

Features of Monnit ALTA Sensors

- Wireless range of 1,000+ feet through 12-14 walls *
- Frequency Hopping Spread Spectrum (FHSS)
- Improved interference immunity
- Improved power management for longer battery life ** (10+ years on AA batteries)
- Encrypt-RF™ Security (Diffie-Hellman Key Exchange + AES-128 CBC for sensor data messages)
- Onboard data memory / storage (up to 512 readings per sensor)
 - 10 min heartbeats = 3.5 days
 - 2 hour heartbeats = 42 days
- Over-the-air updates (future proof)
- Free iMonnit basic online wireless sensor monitoring and notification system to configure sensors, view data and set alerts via SMS text and email.

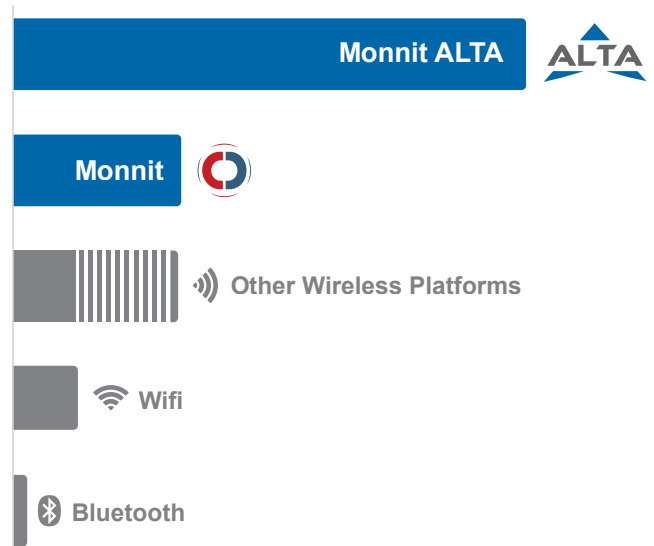

* Actual range may vary depending on environment.
 ** Battery life is determined by sensor reporting frequency and other variables. Other power options are also available.

Wireless Range Comparison

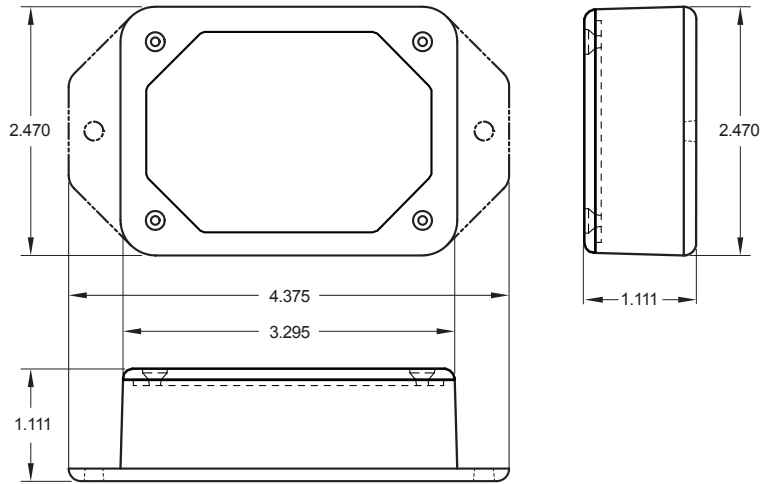



ALTA Commercial AA Wireless Low Temperature Sensor - Technical Specifications

Supply Voltage	2.0 - 3.8 VDC (3.0 - 3.8 VDC Using Power Supply) *
Current Consumption	0.2 μ A (Sleep Mode) 0.7 μ A (RTC Sleep) 570 μ A (MCU Idle) 2.5 mA (MCU Active) 5.5 mA (Radio RX Mode) 22.6 mA (Radio TX Mode)
Operating Temperature Range (Board Circuitry and Batteries)	-18°C to 55°C (0°F to 130°F) using alkaline -40°C to 85°C (-40°F to 185°F) using lithium **
Optimal Battery Temperature Range (AA)	+10°C to +50°C (+50°F to +122°F)
RTD Temperature Range (RTD and Cable Only)	-200°C to +162°C (-328°F to +325°F)
Accuracy @ 0°C	+/- 3.3°C Standard (+/- 0.5°C Calibrated) ***
Dissipation Constant	2mW/°C
Thermal Time Constant	15 sec max.
Integrated Memory	Up to 512 sensor messages
Wireless Range	1,000+ ft. non-line-of-sight
Security	Encrypt-RF™ (256-bit key exchange and AES-128 CTR)
Weight	3.7 Ounces
Certifications	<div style="display: flex; align-items: center; gap: 10px;">    Industry Canada </div> 900 MHz product; FCC ID: ZTL- G2SC1 and IC: 9794A-G2SC1. 868 and 433 MHz product tested and found to comply with: EN 300 220-2 V3.1.1 (2017-02), EN 300 220-2 V3.1.1 (2017-02) and EN 60950.

* Hardware cannot withstand negative voltage. Please take care when connecting a power device.

** At temperatures above 100°C, it is possible for the board circuitry to lose programmed memory.

*** See RTD accuracy chart on last page.

Power Options



The standard version of this sensor is powered by two replaceable 1.5 V AA sized batteries (included with purchase).

This sensor is also available with a line power option. The line powered version of this sensor has a barrel power connector allowing it to be powered by a standard 3.0 - 3.6 V power supply. The line powered version also uses two standard 1.5 V AA batteries as backup for un-interrupted operation in the event of line power outage.

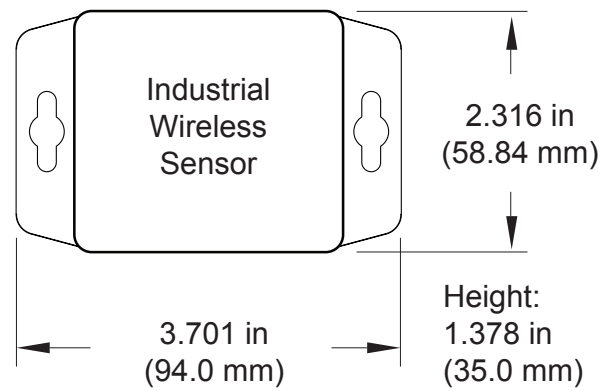
Power options must be selected at time of purchase, as the internal hardware of the sensor must be changed to support the selected power requirements.



ALTA Industrial Wireless Low Temperature Sensor - Technical Specifications

Supply Voltage	2.0 - 3.8 VDC (3.0 - 3.8 VDC Using Power Supply) *	
Current Consumption	0.2 μ A (Sleep Mode) 0.7 μ A (RTC Sleep) 570 μ A (MCU Idle) 2.5 mA (MCU Active) 5.5 mA (Radio RX Mode) 22.6 mA (Radio TX Mode)	
Operating Temperature Range (Board Circuitry and Battery)	-40°C to +85°C (-40°F to +185°F) **	
Included Battery	Max Temperature Range:	-40°C to +85°C (-40°F to +185°F)
	Capacity:	1800 mAh
Optional Solar Feature	Solar Panel:	5VDC / 30mA (53mm x 30mm)
	Charging Temperature Range:	0°C to 45°C (32°F to 113°F)
	Max Temperature Range:	-20°C to 60°C (-4°F to 140°F)
	Included Rechargeable Battery:	600 mAh / >2000 Charge Cycles (80% of initial capacity)
RTD Temperature Range (RTD and Cable Only)	-200°C to +162°C (-328°F to +325°F)	
Accuracy @ 0°C	+/- 3.3°C Standard (+/- 0.5°C Calibrated) ***	
Dissipation Constant	2mW/°C	
Thermal Time Constant	15 sec max.	
Integrated Memory	Up to 512 sensor messages	
Wireless Range	1,000+ ft. non-line-of-sight	
Security	Encrypt-RF™ (256-bit key exchange and AES-128 CTR)	
Weight	4.7 Ounces	
Enclosure Rating	NEMA 1, 2, 4, 4x, 12 and 13 rated, sealed and weather proof	
UL Rating	UL Listed to UL508-4x specifications (File E194432)	
Certifications	   Industry Canada	900 MHz product; FCC ID: ZTL- G2SC1 and IC: 9794A-G2SC1. 868 and 433 MHz product tested and found to comply with: EN 300 220-2 V3.1.1 (2017-02), EN 300 220-2 V3.1.1 (2017-02) and EN 60950.

* Hardware cannot withstand negative voltage. Please take care when connecting a power device.

** At temperatures above 100°C, it is possible for the board circuitry to lose programmed memory.

*** See RTD accuracy chart on last page.

RTD Accuracy		
Temperature (°C)	Accuracy (±°C)	
	Uncalibrated	Calibrated
-200°C	4.30	1.50
-180°C	4.20	1.40
-160°C	4.10	1.30
-140°C	4.00	1.20
-120°C	3.90	1.10
-100°C	3.80	1.00
-80°C	3.70	0.90
-60°C	3.60	0.80
-40°C	3.50	0.70
-20°C	3.40	0.60
0°C	3.30	0.50
20°C	3.40	0.60
40°C	3.50	0.70
60°C	3.60	0.80
80°C	3.70	0.90
100°C	3.80	1.00
120°C	3.90	1.10
140°C	4.00	1.20
160°C	4.10	1.30

Commercial Grade Sensors:

Monnit commercial grade sensors are designed for applications in ordinary environments (normal room temperature, humidity and atmospheric pressure). Do not use these sensors under the following conditions as these factors can deteriorate the product characteristics and cause failures and burn-out.

- Corrosive gas or deoxidizing gas - chlorine gas, hydrogen sulfide gas, ammonia gas, sulfuric acid gas, nitric oxides gas, etc.)
- Volatile or flammable gas
- Dusty conditions
- Under low or high pressure
- Wet or excessively humid locations
- Places with salt water, oils chemical liquids or organic solvents
- Where there are excessively strong vibrations
- Other places where similar hazardous conditions exist

Use these product within the specified temperature range. Higher temperature may cause deterioration of the characteristics or the material quality.

Industrial Grade Sensors - Type 1, 2, 4, 4X, 12 and 13 NEMA Rated Enclosure:

Monnit's Industrial sensors are enclosed in reliable, weatherproof NEMA rated enclosures. Our NEMA rated enclosures are constructed for both indoor or outdoor use and protect the sensor circuitry against the ingress of solid foreign objects like dust as well as the damaging effects of water (rain, sleet, snow, splashing water, and hose directed water).

- Safe from falling dirt
- Protects against wind blown dust
- Protects against rain, sleet, snow, splashing water, and hose directed water
- Increased level of corrosion resistance
- Will remain undamaged by ice formation on the enclosure



For more information about our products or to place an order, please contact our sales department at 801-561-5555.

Visit us on the web at www.monnit.com.

Monnit Corporation
 3400 South West Temple
 Salt Lake City, UT 84115
 801-561-5555
www.monnit.com