



Product specification

Displacement Transmitter Series DT-120

Non-contacting integrated displacement transmitter

Features

- Maximum linear range 2 mm (0.5 - 2.5 mm from target)
- Loop-powered
- Driver electronics are built into the transmitter housing
- Temperature range: -40 °C ... +105 °C.
- Dynamic signal output for easy installation (raw signal)
- Cost-saving installation – no separate driver needed



Measurement



Radial shaft vibration

DT-12x.RV¹



Axial shaft position

DT-12x.AP¹

Product description

The integrated DT-120 series displacement transmitters are based on the non-contacting eddy current measurement principle, which has proven itself in the machine monitoring sector for several decades. It allows the distance between the tip of the displacement transmitter and an electrically conductive surface to be measured. The integrated electronics measure the axial shaft position or the radial shaft vibration from the displacement signal, depending on the model being used. The measurement result is outputted to a subsequent controller, via the loop-powered interface, as a 4 - 20 mA signal. An additional dynamic output provides a diagnostic signal for simple system setup or signal analysis. Our series DT-120 eddy current displacement transmitters are distinguished by their innovative design. All of the measuring electronics and the loop-powered interface are integrated in the transmitter's housing. This considerably simplifies the installation of these systems as compared to those with external driver electronics. The displacement transmitter is available in both forward and reverse mount versions.

Contents

Non-contacting integrated displacement transmitter	1
Features	1
Measurement	1
Product description	1
Technical data	2
Notes on operation	4
Clearances and minimum distances	5
Mechanical versions	6
Displacement transmitter order code	8
Accessories	9
Approval / Declaration of Conformity	10

¹ "x" option defines the housing version



Technical data

The following performance data applies under the following standard conditions, unless stated otherwise: +18 °C to +27 °C ambient temperature, +24 VDC supply voltage, 250 Ω loop resistance, dynamic output not connected, B&K Vibro original reference material, Material-No. 1.7225 (42CrMo4) as per EN10083-3 and as per AISI/SAE 4140, +6 V gap voltage; all components are at operating temperature (approx. 1h).

Measurement type:

Radial Vibration (RV)	Radial shaft vibration in [μm peak-to-peak]
Axial Position (AP)	Axial shaft position in [μm]
Measuring principle	Eddy current method

Functional characteristics:

Loop output:

Output signal	4 - 20 mA, live-zero
Signaling (range overshoot, error)	As per NAMUR Recommendation 43
System error	< 3,6 mA
Full scale range overshoot (RV + AP)	20,5 mA
Full scale range undershoot (AP only)	3,8 mA
Loop resistance	
Nominal	250 Ω
Maximal	depends on the supply voltage V_{Loop} (see Fig. 1)
Accuracy	
0 °C ... +45 °C	±0,2 % from full scale (FS)
Overall operating temperature range	±0,5 % (FS)

Installation Position Transmitter (GAP):

Transmitter must be gapped from target (shaft) between equal to linear range	+2V to +18V > 0.5mm to < 2.5mm
--	-----------------------------------

Radial shaft vibration (DT-12x.RV):

Full scale range, nominal	[μm peak-peak]	0 – 100		0 – 250		0 – 600
Loop sensitivity, nominal	[μm p-p/mA]	6,25		15,63		37,5
Full scale range, nominal	[mils peak-peak]	0 – 4		0 – 10		0 – 24
Loop sensitivity, nominal	[mils p-p/mA]	0,25		0,625		1,5
Sensitivity accuracy						
in the temperature range of:						
0 °C ... +45 °C						±5 %
Overall operating temperature range						±10 %
Loop frequency range		5 Hz ... 4 kHz				
Loop refresh time		15 ms				

Axial shaft position (DT-12x.AP):

Full scale range, nominal	[mm]	0 – 1,2		0 – 1,5
Loop sensitivity, nominal	[μm /mA]	75,0		93,8
Full scale range, nominal	[mils]	0 – 50		0 – 60
Loop sensitivity, nominal	[mils/mA]	3,125		3,75
Accuracy				
Deviation (DSL) from best fit straight line with nominal loop sensitivity in the temperature range of:				
0 °C ... +45 °C				±25 μm
Overall operating temperature range				±75 μm
Loop frequency range		DC ... 0,8 Hz		
Loop refresh time		100 ms		

Dynamic output:

Application	Connection of a potential-free portable measuring instrument for system setup or signal analysis; not designed for continuous operation; limited cable length
Cable length	max. 15 m (including transmitter integrated cable length)
Cable capacity	max. 150 pF/m
Output resistance	8 k Ω DC (load > 500 k Ω , 1,5 nF)
Output signal	Depends on the loop voltage and loop resistance, see Table 1
Sensitivity, nominal	+8 mV/ μ m
Frequency range	DC ... 8 kHz (-3 dB output signal damping)
Accuracy	
0 °C ... +45 °C	\pm 5 %
Overall operating temperature range	\pm 10 %
Behaviour in the event of maximum linear range overshoot or system error	Output remains active; max. output voltage depends on loop voltage; short voltage dips at the start of signaling of a measuring range overshoot is possible
Design	short circuit proof and miswiring proof

Electrical properties:

Operating voltage	+24 VDC (+12 VDC ... +32 VDC)
Current consumption	max. 21 mA

Mechanical properties:

Cable:	
Design	4 wire
Cable sheath and colouring	PTFE, black
Wire assignments:	
Loop	white (+), black (-)
Dynamic output	red (+), blue (-)
Diameter	\varnothing 2,9 mm (\pm 0,15 mm)
Wire cross-section	0,16 mm ²
Length	5 m or 10 m

Transmitter tip:

Material	Ceramic
Tip diameter	\varnothing 7,2 mm (\pm 0,1 mm)

Transmitter sleeve:

Material	Stainless steel (Material-No.1.4404 X2CrNiMo17-12-2 nach EN10088-3)
Recommended tightening torque	5 Nm
Transmitter weight (5m version):	approx. 150 g

Environment:

Pressure tightness:	
Transmitter tip	25 bar
Transmitter with corrugated tube protection	25 bar (valid only for DT-122)
Temperature range:	
Operating temperature range	-40 °C ... +105 °C
Storage temperature range	-55 °C ... +125 °C
IP protection degree according to EN 60529	IP68, IP69



Notes on operation

Maximum loop resistance $R_{Loop-max}$

The total loop resistance consists of the measuring resistance of the supplying electronics and the effective cable resistance:

- $R_{Loop} = R_{Meas} + R_{Cable}$

The maximum permissible loop resistance for a given voltage supply V_{Loop} is calculated using the following formula:

- $R_{Loop-max} = 47 \times (V_{Loop} - 12) \text{ [Ohm]}$

The diagram shows the relationship between the supply voltage V_{Loop} and the maximum permitted loop resistance.

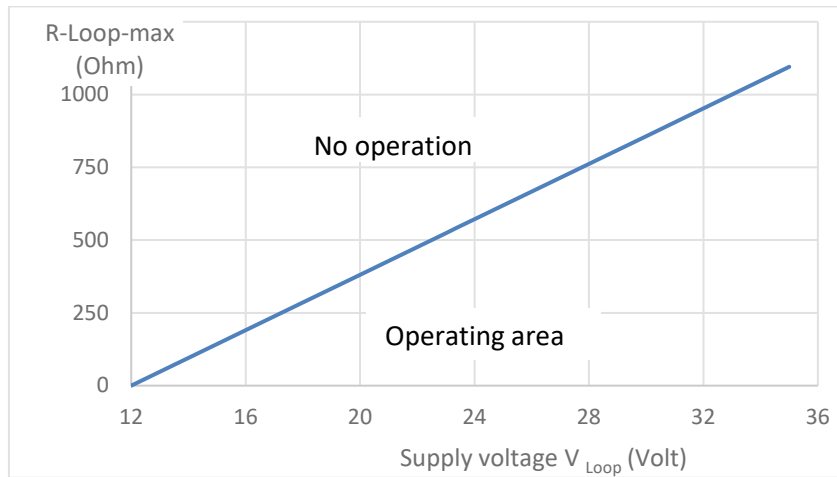

Figure 1) Dependency of the supply voltage on the maximum loop resistance

Range of the maximum dynamic output signal

The output of the diagnostic signal via the dynamic output DYN_OUT requires a sufficiently high supply voltage V_{Loop} for a given loop resistance R_{Loop} :

$$DYN_OUT < V_{Loop} - I_{Loop} \times R_{Loop} - 2.6 \text{ V}$$

Table 1) shows the relationships between the maximum outputted DYN_OUT and R_{Loop} and V_{Loop}

V_{Loop}	R_{Loop}		
	100 Ω	250 Ω	500 Ω
20 V	15.4 V	12.4 V	¹⁾
24 V	19.4 V	16.4 V	11.4 V
28 V	21.4 V ²⁾	20.4 V	15.4 V

Table 1) DYN_OUT_{Max} (R_{Loop} , V_{Loop})

1) No operation possible

2) Voltages higher than 21.4 V cannot be outputted.

In case of insufficient supply voltage V_{Loop} , the DYN_OUT dynamic output signal range might be limited.

Clearances and minimum distances

The clearances and minimum distances specified below must be observed when installing the transmitter.

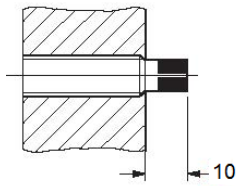

Protruding transmitter tip

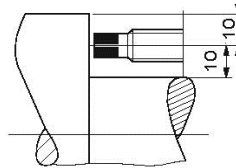

Distance to the shaft shoulder Transmitter parallel to electrically conductive material

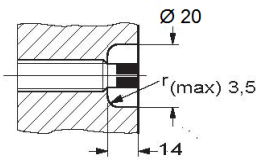

Flush transmitter tip

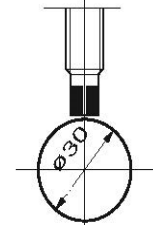

Required minimum shaft diameter for one transmitter

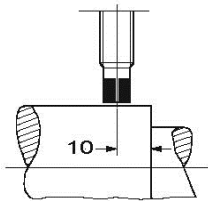

Distance to a shaft end

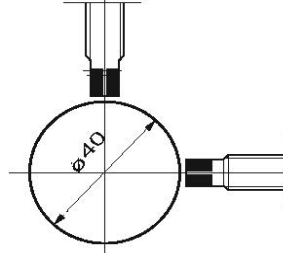

Required minimum shaft diameter with two transmitters

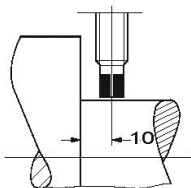

Distance to the shaft shoulder Transmitter parallel to electrically conductive material

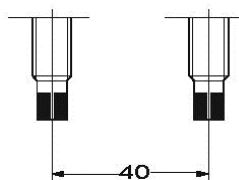

Transmitters installed in parallel



Mechanical versions²

Displacement transmitter with continuous thread DT-121...

- Without cable protection: DT-121.MT/MR/TT/LLL/UUU/PPP/000/R (upper image)
- With steel protective conduit, Length XX: DT-121.MT/MR/TT/LLL/UUU/PPP/2XX/R (centre image)
- With PTFE protective conduit, Length XX: DT-121.MT/MR/TT/LLL/UUU/PPP/3XX/R (lower image)

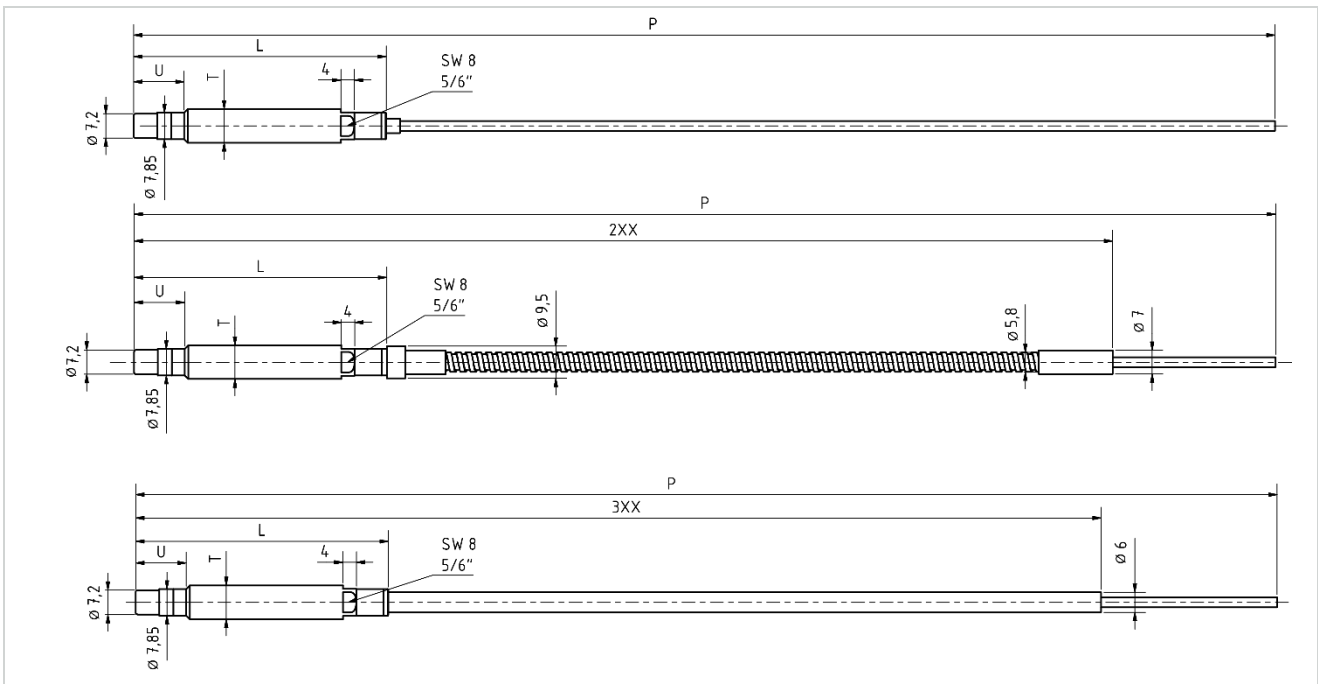

Displacement transmitter with continuous thread and pressure-tight corrugated tube DT-122...

- With corrugated tube protection design A, Length XX: DT-122.MT/MR/TT/LLL/UUU/PPP/4XX/R (upper image)
- With corrugated tube protection design B, Length XX: DT-122.MT/MR/TT/LLL/UUU/PPP/5XX/R (lower image)

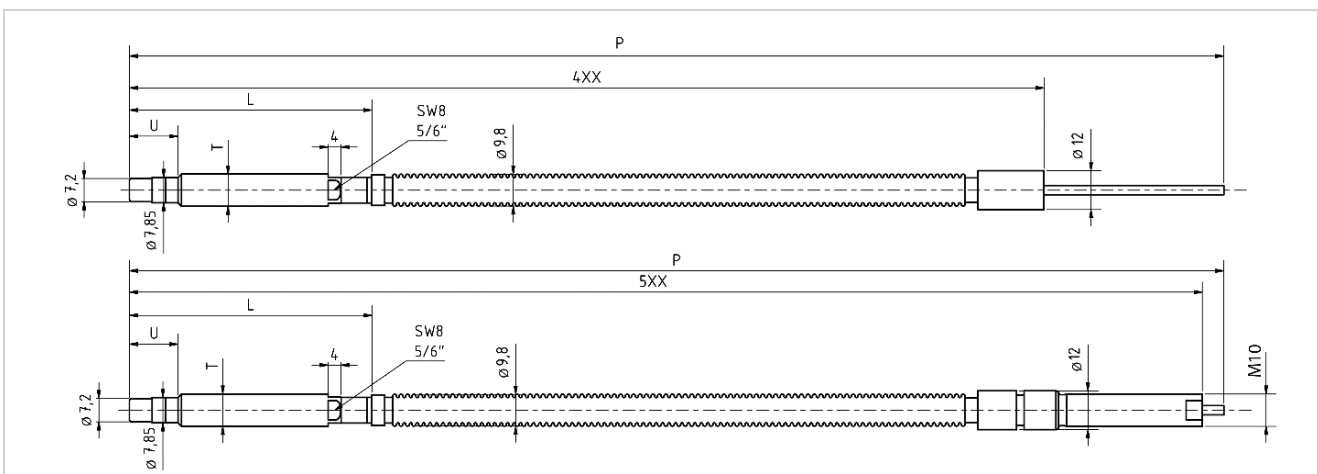

² Comments about drawings: all information is in [mm]

Displacement transmitter for reverse mount DT-123...

- Without cable protection *DT-123.MT/MR/TT/073/013/PPP/000/R* (upper image)
- With steel protective conduit, Length XX: *DT-123.MT/MR/TT/073/013/PPP/2XX/R* (centre image)
- With PTFE protective conduit, Length XX: *DT-123.MT/MR/TT/073/013/PPP/3XX/R* (lower image)

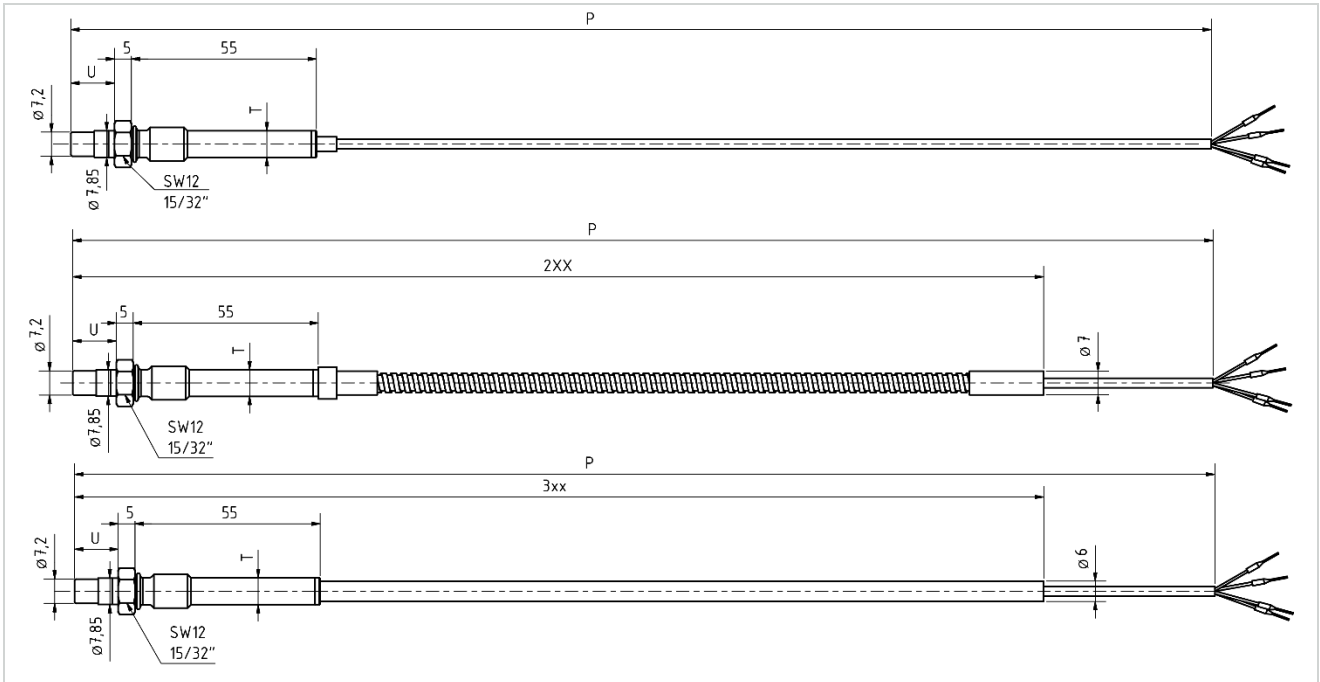



Displacement transmitter order code

DT-12D.MT / MR / TT / LLL / UUU / PPP / CXX / R

	DT-121	DT-122	DT-123	DT-12...
“D” transmitter type				D
Continuous thread	<input checked="" type="checkbox"/>			1
Continuous thread with corrugated tube		<input checked="" type="checkbox"/>		2
Reverse mount			<input checked="" type="checkbox"/>	3

“MT” Measurement type				.MT
Radial shaft vibration (RV)		<input checked="" type="checkbox"/>		RV
Axial shaft position (AP)			<input checked="" type="checkbox"/>	AP

“MR” Measuring Range				/ MR
RV [µm] / AP [mm]		100	1.2	0
		250	1.5	1
		600		2
RV [mils] / AP [mils]		4	50	5
		10	60	6
		24		7

“T” Thread				/ TT
M10 x 1		<input checked="" type="checkbox"/>	<input checked="" type="checkbox"/>	10
3/8 – 24 UNF-2A		<input checked="" type="checkbox"/>	<input checked="" type="checkbox"/>	62

“L” Length of the transmitter body [mm]				/ LLL
Increment 005 = 5 mm				
Preferred lengths	75	75		075
	90	90		090
	105	105		105
	125	125		125
Fixed length			73	073
Other lengths min - max	75 - 250	75 - 250		xxx

	DT-121	DT-122	DT-123	DT-12...
“U” unthreaded section [mm]				
$U_{\max} = L - 40 \text{ mm}$; increment '005' = 5 mm (as from “U” = 15 mm) Distance measured from tip of transmitter to non-threaded section				/ UUU
Preferred length	15	15		015
Fixed length			13	013
Other lengths min - max	20 - 210	20 - 210		XXX
“P” Length of the integrated cable [dm]				/ PPP
	5.0	5.0	5.0	050
	10.0	10.0	10.0	100
“CXX” Cable protection for integrated cable [dm]				
The minimum length is '05' = 0,5 m with fixed increments of 0.1 m. CXX = '000' means "no protection" and XX = '99' for maximum possible cable protection for the transmitter version (the protection ends approx. 0.4 m from the end of the cable).				/ CXX
No protection	<input checked="" type="checkbox"/>		<input checked="" type="checkbox"/>	000
Steel protective conduit	<input checked="" type="checkbox"/>		<input checked="" type="checkbox"/>	2XX
PTFE protective conduit	<input checked="" type="checkbox"/>		<input checked="" type="checkbox"/>	3XX
Corrugated tube protection, design A		<input checked="" type="checkbox"/>		4XX
Corrugated tube protection, design B		<input checked="" type="checkbox"/>		5XX
“R” Special requirements				/ R
No	<input checked="" type="checkbox"/>	<input checked="" type="checkbox"/>	<input checked="" type="checkbox"/>	0
Yes (need to be put in writing)	Upon request			1

Accessories

AC-2140: two channel connection module



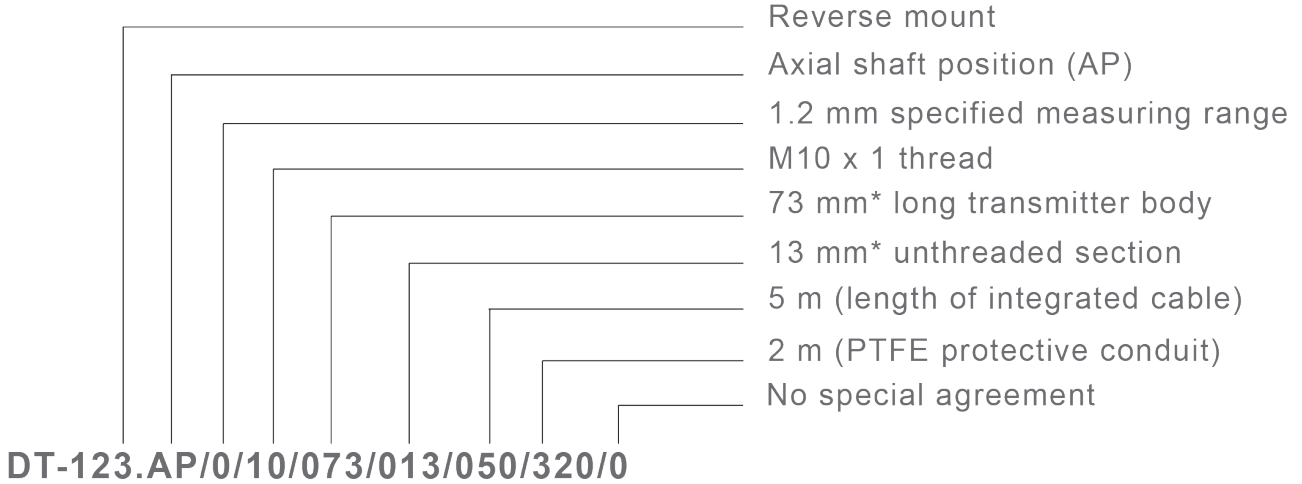

Order example



* fixed length, as it is reverse mount

Approval / Declaration of Conformity

Displacement transmitter systems are:

CE Conformity as per EMC Directive EN 61326-1: 2013 EN 50581: 2012	
RCM for Australia and New Zealand	



Contact details

Brüel & Kjaer Vibro GmbH

Leydheckerstrasse 10

64293 Darmstadt

Germany

Telephone: +49 6151 428 0

Fax: +49 6151 428 1000

Transmitter Series DT-120 • BPS0157-EN-13 • © Brüel & Kjaer Vibro •

We reserve the right to make technical changes!