



# OMEGA<sup>®</sup>/HBM M Series Encapsulated Foil Strain Gages Glass Fiber Reinforced Phenolic Carrier

- ✓ High Resistance to Alternating Loads
- ✓ High Temperature Range 300°C (572°F)
- ✓ Wide Spectrum of Different Types

M Series strain gages have been specially developed for high resistance to alternating loads at increased strain levels and high temperatures up to 300°C (572°F). They are foil strain gages with measuring grids made of a special nickel-chromium alloy. OMEGA/HBM offer this special strain gage with various geometries, measuring grid lengths and temperature response matching.

New materials offering high strength such as fiber composites pose a major challenge for strain gages used for measurements specifically when pushing components to their mechanical limit of performance. Situations may arise where a strain gage subjected to alternating loads at increased load levels is weakened and fails earlier than the component under test. The M Series has been specially developed for high resistance to alternating loads and allows for testing of materials featuring high strength.

All M Series strain gage types are available with different measuring grid lengths:

- 1.5 mm: where space is a constraint or when highly selective measurement results are required
- 3 mm: for inhomogeneous materials and where space is a requirement or not
- 6 mm: for inhomogeneous materials and where space is not a requirement

The right measuring grid length: The measuring grid length depends on the aim of measurement, since the result of a measurement with strain gages will be determined as the average of strains. In general, measuring grid lengths of 3 to 6 mm (0.06 to 0.24") generates a better result.

Long measuring grids are recommended where there is an inhomogeneous material such as concrete or wood. A long strain gage will bridge the inhomogeneity of the work piece and return the strain underneath the measuring grid as the measurement result.

Short measuring grids are suitable for detecting a local strain state. Therefore, they are suitable for determining strain gradients, the maximum point of notch stresses and similar stresses.

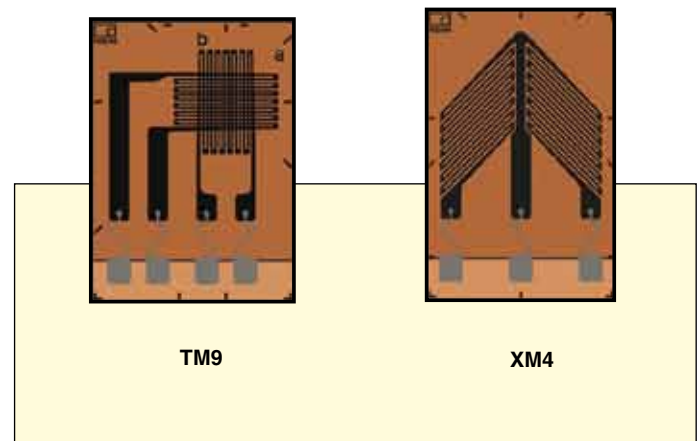
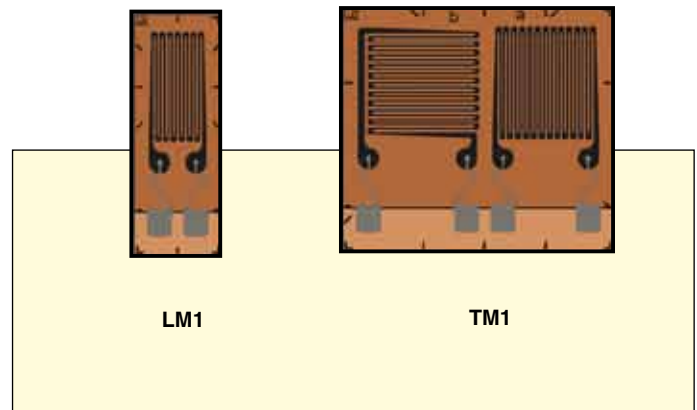

All models shown larger than actual size.

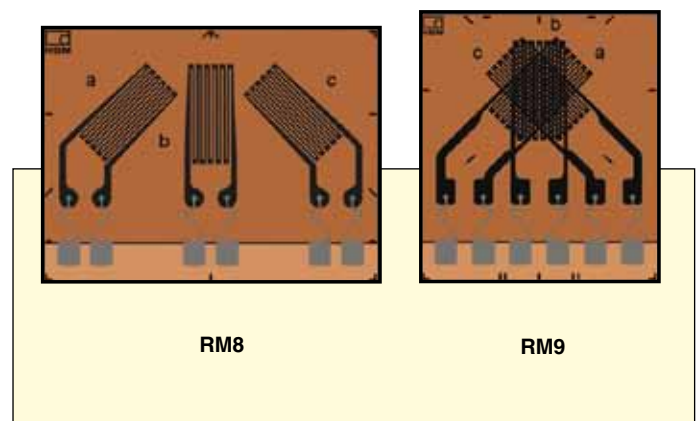



## Specifications

### Strain Gage Construction–Foil Strain Gage

#### Carrier:

**Material:** Glass fiber reinforced phenolic  
**Thickness:** 35 ±10 µm

#### Grid Foil:

**Material:** CrNi  
**Thickness:** 5 µm

#### Encapsulation:

**Material:** Polyimide film  
**Thickness:** 25 ±5 µm

#### Connections:

Solder pads with strain relief

**Resistance:** 350 and 1000 Ω

**Resistance Tolerance:** ±0.3%<sup>(1)</sup>

**Gage Factor:** Approximate 2.2 (specified on each package)

**Gage Factor Tolerance:** ±1.5% (for grid length <3 mm)  
 ±0.7% (for grid length ≥3 mm)

#### Temperature Coefficient of the Gage Factor:

Specified on each package

#### Transverse Sensitivity:

Specified on each package

#### Operating Temperature Range:

-200 to 300°C (-328 to 662°F)

#### Temperature Response (Ferrite Steel):

10.8 ppm/K (6.0 ppm/°F)

#### Maximum Elongation:

**Positive Direction:** 10,000 µm (1%)  
**Negative Direction:** 15,000 µm (-1.5%)

<sup>(1)</sup>For stacked rosettes 0.5%. <sup>(2)</sup>Maximum zero point drift ±100 µm/m.

<sup>(3)</sup>Consider temperature limits of the different adhesives.

**Minimum Bending Radius:** 5 mm (0.20") for linear gages  
 10 mm (0.39") for stacked rosettes

#### Bonding Material that Can Be Used<sup>(3)</sup>:

Z70 or EP310S

#### Fatigue Life (Test to Failure<sup>(2)</sup>)

10<sup>7</sup> cycles at 2000 µm/m

10<sup>6</sup> cycles at 2200 µm/m

10<sup>4</sup> cycles at 3100 µm/m

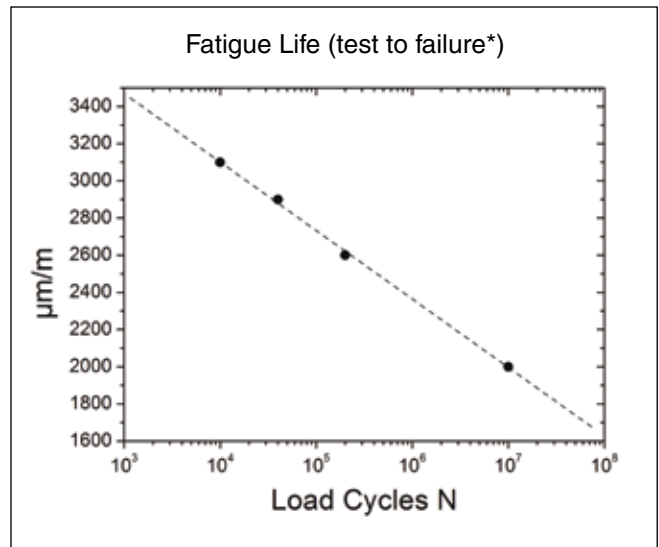





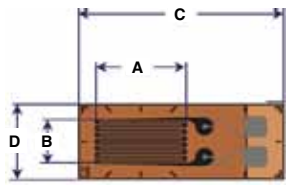

## Geometries

	<b>LM1</b> Linear strain gage with one measurement grid measuring strain in one direction
	<b>TM1</b> T rosette with two measurement grids, offset by 90° measuring tension and compression
	<b>TM9</b> Stacked T rosette with two measurement grids, offset by 90° measuring tension and compression
	<b>XM4</b> V-shaped strain gage with two measurement grids, arranged at ±45° to the axis determination of shear stresses
	<b>RM8</b> Rectangular strain gage rosette with three measurement grids at 0°/45°/90° biaxial stress state with unknown principal stress direction
	<b>RM9</b> Stacked strain gage rosette with three measurement grids at 0°/45°/90° biaxial stress state with unknown principal stress direction

\* Maximum zero point drift ±100 µm/m

## To Order

	Model No.	Nominal Resistance $\Omega$	Dimensions: mm (inch)				Maximum Permanent Effective Excitation Voltage <sup>(1)</sup>
			Measurement Grid		Carrier		
			A	B	C	D	
<b>LM1</b> 	<b>1-LM11-1.5/350GE</b>	350	1.5 (0.06)	2.5 (0.10)	9 (0.35)	4.4 (0.17)	7
	<b>1-LM11-3/350GE</b>	350	3 (0.12)	3.4 (0.13)	11.8 (0.46)	5.4 (0.21)	11
	<b>1-LM11-6/350GE</b>	350	6 (0.24)	3.4 (0.13)	14.8 (0.58)	5.4 (0.21)	16
<b>TM1</b> 	<b>1-TM11-1.5/350GE</b>	350	1.5 (0.06)	2.5 (0.10)	9.5 (0.37)	8 (0.31)	7
	<b>1-TM11-3/350GE</b>	350	3 (0.12)	3.4 (0.13)	11.7 (0.46)	10.6 (0.42)	11
	<b>1-TM11-6/350GE</b>	350	6 (0.24)	6.3 (0.29)	15 (0.59)	16.6 (0.65)	22
<b>TM9</b> 	<b>1-TM91-1.5/350GE</b>	350	1.5 (0.06)	2.5 (0.10)	11.3 (0.44)	7.9 (0.31)	5.8
	<b>1-TM91-3/350GE</b>	350	3 (0.12)	3.7 (0.15)	15 (0.59)	11.7 (0.46)	10
	<b>1-TM91-6/350GE</b>	350	6 (0.24)	3.7 (0.15)	18 (0.71)	13 (0.51)	14
<b>XM4</b> 	<b>1-XM41-1.5/350GE</b>	350	1.5 (0.06)	1.5 (0.06)	10.6 (0.42)	6 (0.24)	5.4
	<b>1-XM41-3/350GE</b>	350	3 (0.12)	3 (0.12)	15 (0.59)	8.2 (0.32)	10
	<b>1-XM41-6/350GE</b>	350	6 (0.24)	4 (0.16)	18.6 (0.73)	12.2 (0.48)	17
<b>RM8</b> 	<b>1-RM81-1.5/350GE</b>	350	1.5 (0.06)	2.5 (0.10)	11 (0.43)	13.3 (0.52)	7
	<b>1-RM81-3/350GE</b>	350	3 (0.12)	3.4 (0.13)	14.6 (0.57)	18.4 (0.72)	11
	<b>1-RM81-6/350GE</b>	350	6 (0.24)	3.4 (0.13)	17.1 (0.67)	22.5 (0.86)	16
<b>RM9</b> 	<b>1-RM91-1.5/350GE</b>	350	1.5 (0.06)	2.5 (0.10)	11.3 (0.44)	11.1 (0.44)	5.3
	<b>1-RM91-3/350GE</b>	350	3 (0.12)	3.7 (0.15)	15 (0.59)	16 (0.63)	9.3
	<b>1-RM91-6/350GE</b>	350	6 (0.24)	3.7 (0.15)	18 (0.71)	16 (0.63)	13

<sup>(1)</sup> Maximum permitted effective excitation voltage specified for steel material.

**Ordering Example:** 1-RM91-1.5/350GE, package of 5 encapsulated strain gages, 1.5 mm (0.06") measuring grid length.

**Note:** All models sold in a 5-pack, except 1-LM11 which are sold in a 10-pack.

1-Z70



1-EP310S



1-BCY01



1-RMS1



1-RMS1-SPRAY



## Accessories

Model No.	Description
<b>1-Z70</b>	Rapid adhesive; single component cold curing adhesive made of cyanacrylate
<b>1-EP310S</b>	High temperature adhesive; two-component epoxy resin adhesive
<b>1-BCY01</b>	Accelerator for Z70 rapid adhesive; epoxy resin adhesive
<b>1-RMS1*</b>	Cleaning solvent; environmentally friendly mixture of isopropanol and acetone
<b>1-RMS1-SPRAY**</b>	Spray version of RMS1 cleaning solvent

\* NOTE: Satisfactory bonding joints are only achieved if the adhesive covers the bonded surfaces well. Therefore, the application surfaces must be cleaned prior to bonding with a chemically pure solvent and a clean cleaning pad.

\*\* NOTE: 1-RMS1-SPRAY enables the chemically pure cleaning agent to be easily and reliably applied, for example, when preparing measuring points on vertical surfaces or working overhead. Comes in packages containing five 200 ml spray cans and 450 cleaning pads.