

HEAVY-DUTY USB OUTPUT PRESSURE TRANSDUCER

STANDARD AND METRIC MODELS

High Speed
1000 Updates/per
Second

USB Output
750 to 30,000 psi—Standard Models
60 to 400 bar—Metric Models

1 bar = 14.5 psi
1 kg/cm² = 14.22 psi
1 atmosphere = 14.7 psi
= 29.93 inHg = 760.2 mmHg = 1.014 bar



PX51/PXM51-USBH Series

- ✓ High Speed!
1000 Readings/Second
- ✓ Free Software Included
- ✓ All Stainless Steel Body
- ✓ Heavy-Duty Construction
for Harsh Environments
- ✓ Available in Gage, Sealed
Gage, and Absolute
Pressure Models

The PX51 high speed USBH Series connects directly to your computer. Free PC software enables you to chart, log, display, and output data for analysis. Also included are .NET APIs, and a command set for command-line access. The high accuracy, rugged, low-cost transducer has an all stainless steel construction, making it suitable for the harshest environments. A 2 m (6') USB cable is standard.

SPECIFICATIONS

Accuracy: 0.25% full scale linearity and hysteresis combined
Resolution: Up to 5.5 significant figures
Bandwidth: DC to 1000 updates per second typical (±3%)
A to D Conversion: 24-bit
Output: Digital (USB)

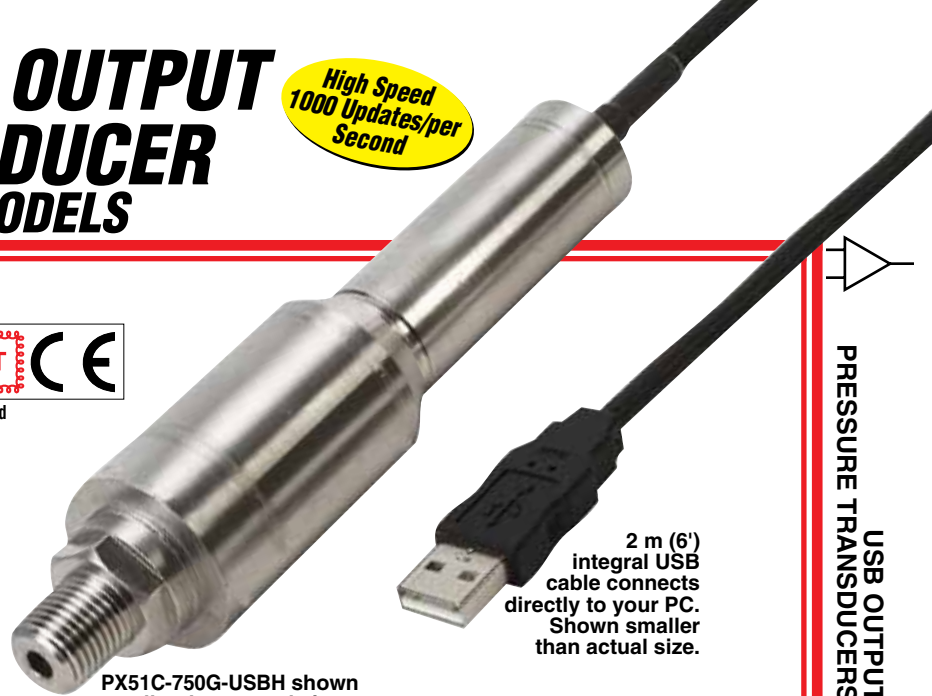

PX51C-750G-USBH shown smaller than actual size.

2 m (6')
integral USB
cable connects
directly to your PC.
Shown smaller
than actual size.



USB OUTPUT
PRESSURE TRANSDUCERS
B

FREE OMEGA® USBH Downloadable Software!

OMEGA is excited to announce the release of a major software update for USB Transducers! The fresh look and added features add even more value and flexibility to your transducer's performance.

Free OMEGA PC software takes the data from the transducer directly to the digital domain, turning your laptop or Windows® tablet (with USB connection) into a virtual meter, chart recorder, or data logger.

Also included are .NET APIs and a set for command-line access. Visit <ftp://ftp.omega.com/public/DASGroup/products/USBH/> to download your free copy.*

*Includes software to run TRH Central compatible devices.

Minimum Isolation: 1 GΩ @ 50 Vdc case to sensor 2MΩ @ 50 Vdc case to output terminations

Shock: 50 g, 11 mS half sine, vertical and horizontal axis

Vibration: 5-2000-5 Hz, 30 minute cycle, Curve L, Mil-Spec 810 figure 514-2-2, vertical and horizontal axis

Power Consumption: 0.35 W typical

CE Compliant: Meets industrial emissions and immunity EN61326

Environmental Protection: IP65

Weight: 400 g (14.1 oz)

Operational Temp Range: -40 to 85°C (-40 to 185°F)

Compensated Temp Range: 16 to 71°C (60 to 160°F)

Thermal Effects:

Span: 0.003% of FSO/°F

Zero: 0.005% of FSO/°F

Proof Pressure: 150% of rated pressure

Burst Pressure: 300% of rated pressure

Wetted Parts: 17-4 PH stainless steel

Pressure Port:

<10,000 psi: See dimensional drawings

≥10,000 psi: 1/16-18, 1/4" HP tube

Excitation: Derived from USB Power

Electrical Connection: 2 m (6') USB type A cable

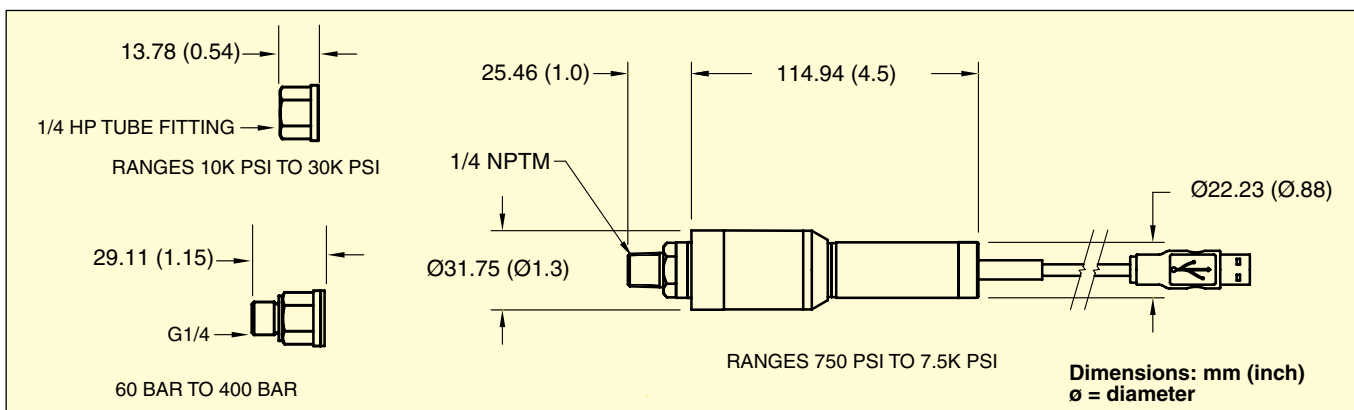

HEAVY-DUTY INDUSTRIAL TRANSDUCER

STANDARD CUSTOM CONFIGURATIONS

PX51 USBH SERIES	PRESSURE PORT [1]	RANGE (psi) [2]	UNITS [3]	ELECTRICAL CONNECTION USBH	OPTIONS [4]
	C = ¼-18 NPT-M (<10,000 psi ranges)	750 1K 1.5K	S,G,A S,G,A S,G,A	2 m (6') USB Type A Cable	Visit us online or consult Omega Pressure for options available on this series.
	S = ¼ HP tube fitting (≥10,000 psi ranges)	2K 2.5K 3K 3.5K 5K 7.5K 10K 15K 20K 30K	S,G,A S,G,A S,G,A S,G,A S,G,A S,G,A S,G,A S,G,A S,G,A S,G,A		

S = Sealed Gage
G = Gage
A = Absolute

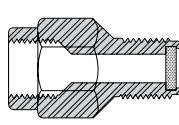

¼ NPT Pressure Snubbers:
PS-4G = Gas
PS-4E = Lt Oil
PS-4D = Dense Lq

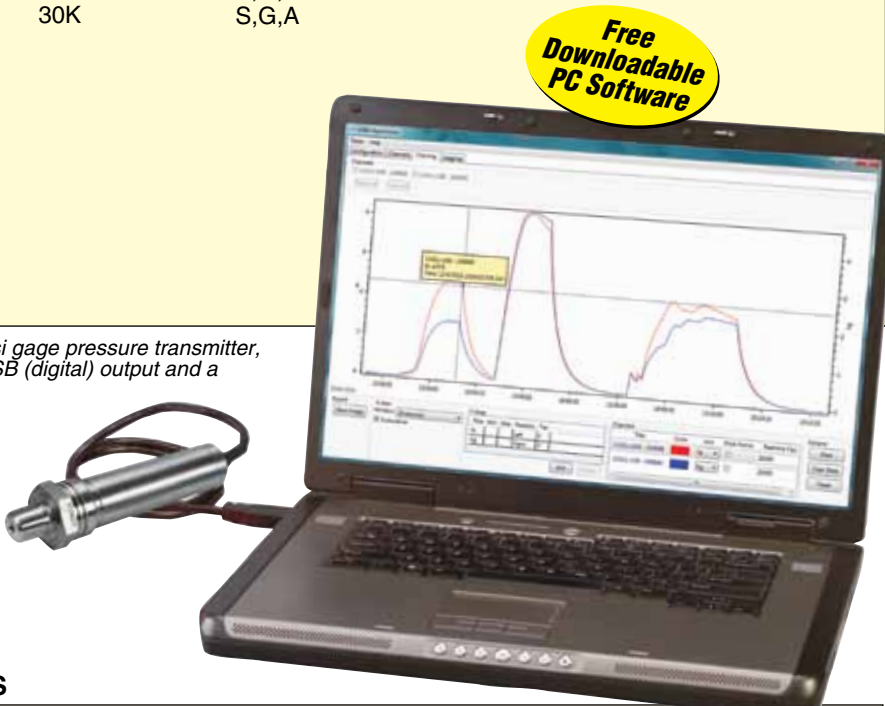

Ordering Example: PX51C-750G-USBH, 750 psi gage pressure transmitter, ¼-NPT male pressure connection, high speed USB (digital) output and a 2 m (6') cable.

- To order a custom configuration:**
1. Select a pressure port
 2. Select a pressure range
 3. Select pressure units
 4. Select options

METRIC CUSTOM CONFIGURATIONS

PXM51 USBH SERIES	PRESSURE PORT [1]	RANGE (bar) [2]	UNITS [3]	ELECTRICAL CONNECTION USBH	OPTIONS [4]
	MC = G¼B Male	060 100 160 250 400	S,G,A S,G,A S,G,A S,G,A S,G,A	2 m (6') USB Type A Cable	Visit us online or consult Omega Pressure for options available on this series.

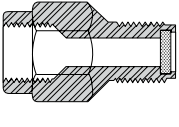

G¼ Pressure Snubbers:
PS-4G-MG = Gas
PS-4E-MG = Lt Oil
PS-4D-MG = Dense Liquid

S = Sealed Gage
G = Gage
A = Absolute

Ordering Example: PXM51MC-160A-USBH, 160 bar absolute pressure transmitter, ¼B male pressure connection, high speed USB (digital) output and a 2 m (6') cable.



To Order

MODELS WITH 1/4-NPT MALE PRESSURE CONNECTION

RANGE		GAGE PRESSURE MODEL NO	ABSOLUTE PRESSURE MODEL NO	SEALED GAGE MODEL NO
PSI	BAR			
0 to 750 psi	0 to 51 bar	PX51C-750G-USBH	PX51C-750A-USBH	PX51C-750SG-USBH
0 to 1K psi	0 to 68.9 bar	PX51C-1KG-USBH	PX51C-1KA-USBH	PX51C-1KSG-USBH
0 to 1.5K psi	0 to 103 bar	PX51C-1.5KG-USBH	PX51C-1.5KA-USBH	PX51C-1.5KSG-USBH
0 to 2K psi	0 to 138 bar	PX51C-2KG-USBH	PX51C-2KA-USBH	PX51C-2KSG-USBH
0 to 2.5K psi	0 to 172 bar	PX51C-2.5KG-USBH	PX51C-2.5KA-USBH	PX51C-2.5KSG-USBH
0 to 3K psi	0 to 206 bar	PX51C-3KG-USBH	PX51C-3KA-USBH	PX51C-3KSG-USBH
0 to 3.5K psi	0 to 241 bar	PX51C-3.5KG-USBH	PX51C-3.5KA-USBH	PX51C-3.5KSG-USBH
0 to 5K psi	0 to 345 bar	PX51C-5KG-USBH	PX51C-5KA-USBH	PX51C-5KSG-USBH
0 to 7.5K psi	0 to 517 bar	PX51C-7.5KG-USBH	PX51C-7.5KA-USBH	PX51C-7.5KSG-USBH

MODELS WITH G1/4B MALE PRESSURE CONNECTION

RANGE		GAGE PRESSURE MODEL NO	ABSOLUTE PRESSURE MODEL NO	SEALED GAGE MODEL NO
BAR	PSI			
60	870	PXM51MC-060G-USBH	PXM51MC-060A-USBH	PXM51MC-060SG-USBH
100	1450	PXM51MC-100G-USBH	PXM51MC-100A-USBH	PXM51MC-100SG-USBH
160	2320	PXM51MC-160G-USBH	PXM51MC-160A-USBH	PXM51MC-160SG-USBH
250	3625	PXM51MC-250G-USBH	PXM51MC-250A-USBH	PXM51MC-250SG-USBH
400	5801	PXM51MC-400G-USBH	PXM51MC-400A-USBH	PXM51MC-400SG-USBH

MODELS WITH 1/4" HP TUBE FITTING

RANGE		GAGE PRESSURE MODEL NO	ABSOLUTE PRESSURE MODEL NO	SEALED GAGE MODEL NO
PSI	BAR			
0 to 10K psi	0 to 689 bar	PX51S-10KG-USBH	PX51S-10KA-USBH	PX51S-10KSG-USBH
0 to 15K psi	0 to 1379 bar	PX51S-15KG-USBH	PX51S-15KA-USBH	PX51S-15KSG-USBH
0 to 20K psi	0 to 1379 bar	PX51S-20KG-USBH	PX51S-20KA-USBH	PX51S-20KSG-USBH
0 to 30K psi	0 to 2068 bar	PX51S-30KG-USBH	PX51S-30KA-USBH	PX51S-30KSG-USBH

Comes complete with 5-point NIST traceable calibration certificate, cable with USB connector, and free downloadable PC software.

Ordering Examples: **PX51C-750G-USBH**, 750 psi gage pressure transmitter, 1/4-NPT male pressure connection, high speed USB (digital) output and a 2 m (6') cable.

PXM51MC-160A-USBH, 160 bar absolute pressure transmitter, 1/4B male pressure connection, high speed USB (digital) output and a 2 m (6') cable.

PX51S-30KSG-USBH, 30K psi sealed gage pressure transmitter, 1/4" HP female tube fitting, high speed USB (digital) output and a 2 m (6') cable.

OMEGA USBH MAJOR SOFTWARE UPDATE

OMEGA is excited to announce the release of a major software update for USB Transducers! The fresh look and added features add even more value and flexibility to your transducer's performance. Free OMEGA PC software takes the data from the transducer directly to the digital domain, turning your laptop or Windows® tablet (with USB connection) into a virtual meter, chart recorder, or data logger. Also included are .NET APIs and a set for command-line access.

Visit <ftp://ftp.omega.com/public/DASGroup/products/USBH/> to download your free copy.*

* Includes software to run TRH Central compatible devices.

Charting Window – The addition of a charting window allows you to see your data graphed in real time. The Y axis is configurable to allow simultaneous graphing of multiple engineering units. You can output the image of your data to a png file.

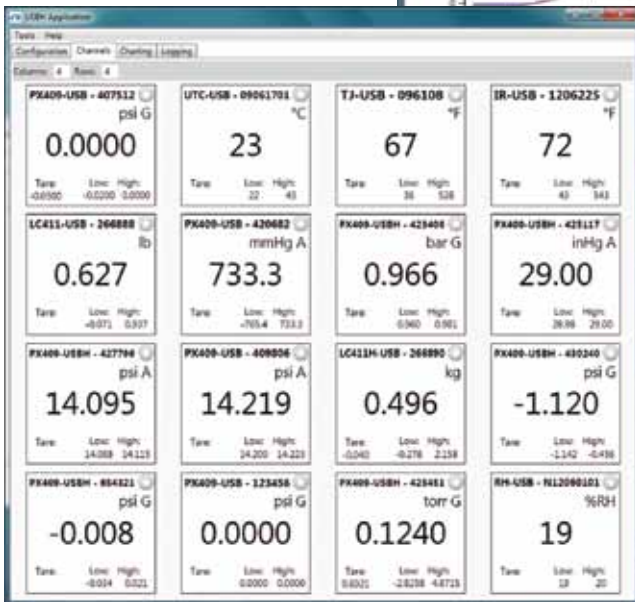
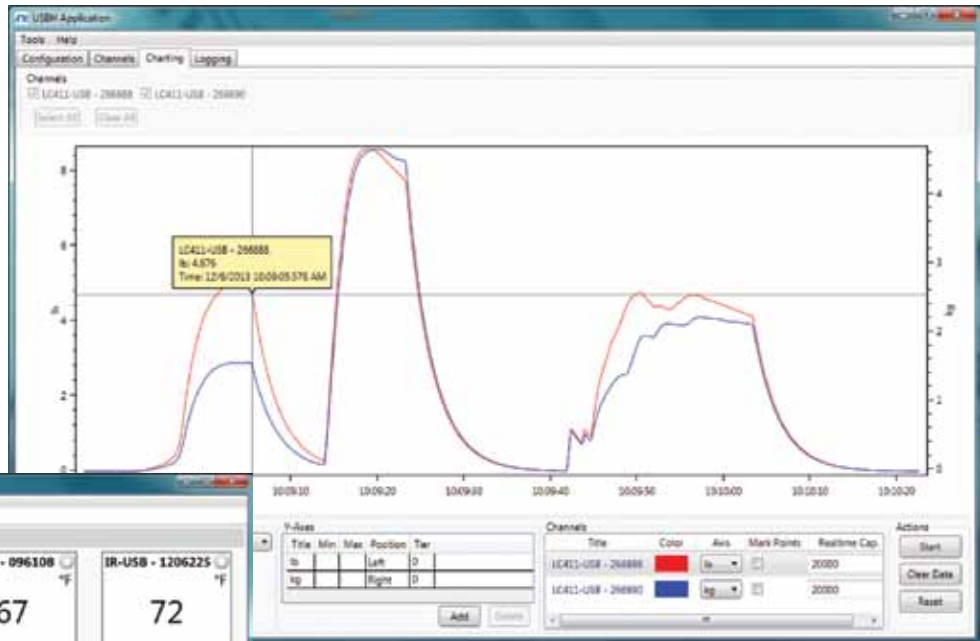

Channels Window – Display data from all of your sensors simultaneously. Each channel has configurable user alarms, three data filters, tare, resettable low/high indication, and sample rates ranging from 30 minutes to 1000 Hz.

PX409-USBH-425117	
Units	psi
Count	10
Last	14.2349
Low	14.2349
High	14.2353

Logging Window – A new xls filetype output option presents preformatted data for readability. In addition, Live Statistics are displayed, including the sensor information, the start/stop time, the number of samples taken, the current reading, and the High/Low readings. With the logging window, you can capture your data for later analysis.

Support for Omega Pressure, Force, Temperature, and Humidity USB Transducers

One software package supports: PX409-*-USB, PX409-*-USBH, LC411-*-USBH, PX51*USBH and IN-USBH*, TJ-USB, IR-USB, RH-USB and UTC-USB transducers.

