

# NORGREN EXCELON® GENERAL PURPOSE COMPRESSED AIR FILTERS

## F72G Series



- In-Line or Modular Installation
- High Efficiency Water and Particle Removal
- Quick Release Bayonet Bowl
- Highly Visible, Prismatic Liquid Level Indicator Lens on Metal Bowls
- Optional Service Indicator Turns from Green to Red When the Filter Element Needs to be Replaced
- Modular Installations with Excelon 72, 73 and 74 Series can be Made to Suit Particular Applications

### SPECIFICATIONS

**Fluid:** Compressed Air

**Operating Pressure:**

**Transparent Bowl:** 10 bar  
(150 psig)

**Metal Bowl:** 17 bar  
(250 psig)

**Operating Temperature\*:**

**Transparent Bowl:**  
-34 to 50°C (-30 to 125°F)

**Metal Bowl:** -34 to 65°C  
(-30 to 150°F)

### F72G MATERIALS

**Body:** Zinc

**Transparent Bowl:** Polycarbonate

**Guard for Transparent**

**Bowl:** Zinc

**Metal Bowl Liquid**

**Level Indicator Lens:**

Transparent nylon

**Element:** Sintered polypropylene

**Elastomers:** Neoprene  
and nitrile



All models shown  
smaller than actual size.

### F73G AND F74G MATERIALS

**Body:** Aluminum

**Transparent Bowl:** Polycarbonate

**Transparent with Guard:**

Polycarbonate, steel guard

**Metal Bowl:** Aluminum

**Metal Bowl Liquid Level**

**Indicator Lens:** Transparent nylon

**Element:** Sintered polypropylene

\* Air supply must be dry enough to  
avoid ice formation at temperatures  
below 2°C (35°F)

Wall mounting bracket (bracket only)

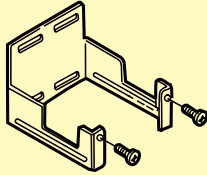

Pipe adaptors (quantity of 1) (NPT)

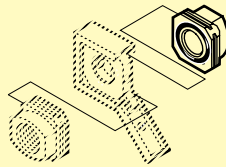

Quickclamp®

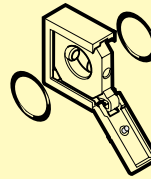

Quickclamp® and wall bracket

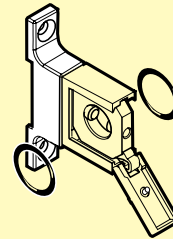

F72G FLOW CHARACTERISTICS

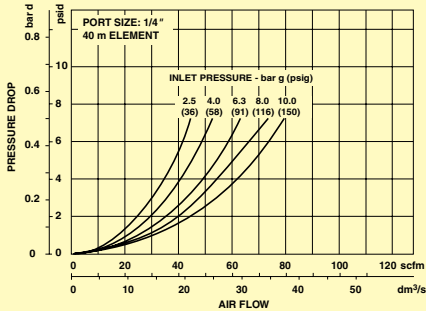

F73G FLOW CHARACTERISTICS

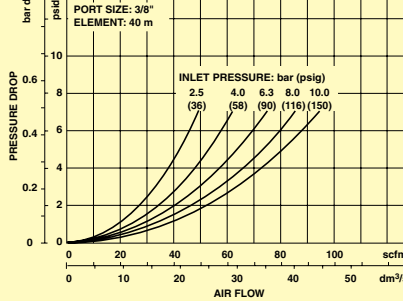

F74G FLOW CHARACTERISTICS

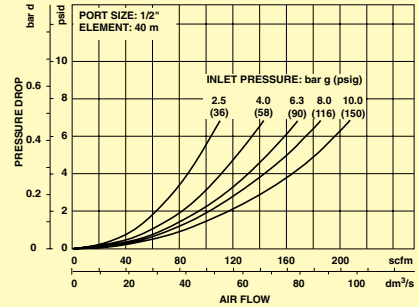

**Auto Drain**

\* Optional service indicator  
# Minimum clearance required to remove bowl

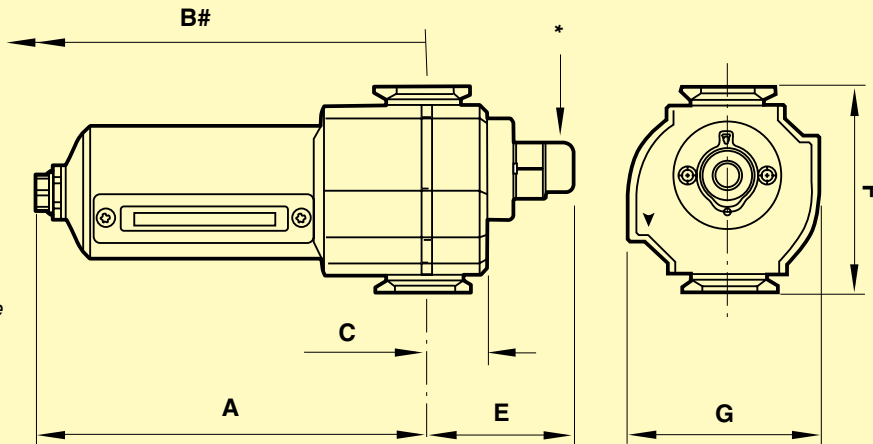

**DIMENSIONS**

SERIES	DRAIN TYPE	A	B	C	E	F	G
<b>STANDARD DIMENSIONS (in)</b>							
72	Auto	5.98	7.99	0.75	2.09	1.97	1.89
72	Manual	5.28	7.28	0.75	2.09	1.97	1.89
73	Auto	6.48	8.84	0.98	2.36	2.68	2.44
73	Manual	6.14	8.50	0.98	2.36	2.68	2.44
74	Auto	7.03	9.75	0.98	2.36	3.15	2.91
74	Manual	6.97	9.69	0.98	2.36	3.15	2.91
<b>METRIC DIMENSIONS (mm)</b>							
72	Auto	152	203	19.1	53.1	50.0	48.0
72	Manual	134	185	19.1	53.1	50.0	48.0
73	Auto	165	225	24.9	59.9	68.1	62.0
73	Manual	156	216	24.9	59.9	68.1	62.0
74	Auto	179	248	24.9	59.9	80.0	73.9
74	Manual	177	246	24.9	59.9	80.0	73.9

**To Order Visit [omega.com/f72g\\_series](http://omega.com/f72g_series) for Pricing and Details**

MODEL NO.	PORT SIZE (in)	FILTER ELEMENT (µM)	DRAIN	FLOW SCFM (DM <sup>3</sup> /S)
F72G-2AN-AE1	¼	5	Auto	55 (26)
F72G-2AN-AE3	¼	40	Auto	55 (26)
F72G-2AN-QE1	¼	5	Manual	55 (26)
F72G-2AN-QE3	¼	40	Manual	55 (26)
F73G-3AN-AD1	⅜	5	Auto	65 (31)
F73G-3AN-AD3	⅜	40	Auto	65 (31)
F73G-3AN-QD1	⅜	5	Manual	65 (31)
F73G-3AN-QD3	⅜	40	Manual	65 (31)
F74G-4AN-AD1	½	5	Auto	112 (53)
F74G-4AN-AD3	½	40	Auto	112 (53)
F74G-4AN-QD1	½	5	Manual	112 (53)
F74G-4AN-QD3	½	40	Manual	112 (53)

**ACCESSORIES**

MODEL NO.	DESCRIPTION
OM-AIR-5797-50	Service life indicator, turns from green to red when the filter element needs to be changed
<b>REPLACEMENT FILTERS</b>	
OM-AIR-5925-03	5 µm filter elements for F72C models
OM-AIR-5925-02	40 µm filter elements for F72C models
OM-AIR-4438-01	5 µm filter elements for F73C models
OM-AIR-4438-03	40 µm filter elements for F73C models
OM-AIR-4338-04	5 µm filter elements for F74C models
OM-AIR-4338-05	40 µm filter elements for F74C models
<b>WALL MOUNTING BRACKET</b>	
OM-AIR-4224-50	Wall mounting bracket for F72G models
OM-AIR-4424-50	Wall mounting bracket for F73G models
OM-AIR-4324-50	Wall mounting bracket for F74G and F74H models
<b>QUICKCLAMPS</b>	
OM-AIR-4214-51	Quick clamp for F72G models
OM-AIR-4314-51	Quick clamp for F73G and F74G models
<b>QUICKCLAMP WALL BRACKET</b>	
OM-AIR-4214-52	Quick clamp wall bracket for F72G models
OM-AIR-4314-52	Quick clamp wall bracket for F73G and F74G models
<b>PIPE ADAPTORS</b>	
OM-AIR-4215-02	Pipe adaptor with ¼ NPT threads for F72G models
OM-AIR-4215-03	Pipe adaptor with ⅜ NPT threads for F72G models
OM-AIR-4315-01	Pipe adaptor with ¼ NPT threads for F73G and F74G models
OM-AIR-4315-02	Pipe adaptor with ⅜ NPT threads for F73G and F74G models
OM-AIR-4315-03	Pipe adaptor with ½ NPT threads for F73G and F74G models
OM-AIR-4315-04	Pipe adaptor with ¾ NPT threads for F73G and F74G models

**Notes:** Models listed include PTF threads, automatic drain, metal bowl with liquid level indicator and a 40 µm element.

† Typical flow with a 40 µm element at 6.3 bar (90 psig) inlet pressure and 0.35 bar (5 psig) pressure drop.

**Ordering Examples:** F72G-2AN-AE3, general purpose filter with ¼" port, metal bowl with liquid level sensor, PTF threads, 40 µm element.  
 F73G-3AN-AD3, general purpose filter with ⅜" port, metal bowl with liquid level sensor, PTF threads, 40 µm element.