

ELC PROGRAMMABLE LOGIC CONTROLLERS AND MODULES



- **Base Models with 10 to 14 I/O, Expandable to 256**
- **Half the Size of Most PLCs**
- **1-, 4-, 8-, 16-and 32-Bit Instructions**
- **DIN Rail Mountable, No Rack Required**
- **Built-in Integral LED Display**
- **High-level Network Access - MODBUS®, DeviceNet and Profibus**
- **Remote Analog Modules for Analog I/O, Thermocouples and RTDs**

The Eaton Logic Controller (ELC) is Eaton Cutler-Hammer's latest offering into the PLC (Programmable Logic Controller) market. Using the latest technology this reduced-sized ELC, with its abundant module selection provides a "just right" concept, for delivering only what you want for the price you desire.

The Right Amount of I/O

Why pay for functionality you'll never need? Why be trapped with functionality that you can't scale to meet changing needs? Eaton is changing everything with the ELC. At less than half the size of most PLCs, the Cutler-Hammer ELC is an ideal solution when space is at a premium and specialized I/O needs present themselves.

ELC's Value Added Differences

4 Controller Styles:

- **Basic**—14 I/O (8I/6O) Over 130 instructions provide all the power you need; 2 serial ports for master/slave communications
- **Clock/Calendar**—Same features as the basic model plus clock/calendar, remote I/O and retentive data storage
- **Analog**—Same features as clock/calendar plus analog in and out
- **High Speed**—All the features of clock/calendar with the ability to capture or output 100 Khz pulses

A Wealth of Features

The ELC family offers four styles of controllers. These controllers offer combinations of the following features:

- High speed pulse capture and high speed pulse output on all controllers
- Interrupts
- Large module selection AC/DC in, relay/transistor out
- Large analog selection of analog in, out, combined, thermocouple, RTD platinum
- Over 200 instructions to choose from: Floating point math, communications, hex, decimal, octal, BCD, ASCII conversion, 1, 4, 8, 16, 32, bit manipulations, logical, block move, block compare, retentive data storage, time base from clock/calendar
- 2 Modbus (ASCII or RTU) serial ports: 1 slave only, 1 master/slave
- ELC controller can be wired for remote I/O communications (except the PB model)

Space Saving, Cost Saving

This space-saving design perfectly fits at home in small machine control stations as well as other enclosed applications where space is critical.

While the ELC is perfectly suited for applications with 40 I/O and less, it can also be expanded to 256 I/O. That means there's no need to change to a different controller as I/O needs expand. Furthermore, the ELC's 2 communication ports can provide any networking task. In remote mode, the ELC exchanges and shares information with up to 16 other devices, in normal mode, the ELC can communicate with up to 32 other devices. Its small size allows for reduced panel size, and saves valuable machine space.

Capability

The ELC provides the instruction set of a large PLC in a small package. It is capable of 1-, 4-, 8-, 16- and 32-bit instructions, block compare, block move, communications, interrupts, clock/calendar and logic, over 240 instructions in all (except PB).

No Racks Required

A DIN rail lets you add as many modules as desired. Just snap on, and slide into place. All connections are done automatically.

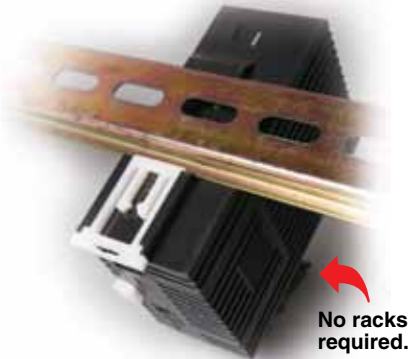

No racks required.

Built-In Display

An integral LED display provides user-assigned process monitoring, error messages, alarms, display counts and more.



Built-in display.



ELC-PA10AADR, shown larger than actual size.

Large PLC Features

Multiple communication ports, remote I/O ability, data storage, high speed counters, high speed pulse outputs, interrupts, timer resolution to 10 ms, PIDs, plus much more.

Easy Connectivity to Drives

ELC communicates easily to MVX drives, eliminating the need to operate drives by analog voltage/current or digital I/O. ELC can access all of the parameters in the MVX by serial communications, saving money.

Remote Communication

All ELC analog type modules are capable of stand-alone operation. Mounted remotely, the ELC communicates to the analog module through its communications port. The ELC also lets you read parameters, set parameters, use scale, offset, and average values.

Software

ELCSoft programs in standard ladder, sequential function chart programming or instruction.

ELC Modules

ELC Expansion Modules

ELC expansion modules provide the correct amount of I/O for application solutions. Choose 8 or 16 I/O expansion modules added to the ELC processor 256 I/O (128 Inputs and 128 maximum).

ELC Specialty Modules

In addition to the expansion specialty modules like analog in, out, Platinum temperature, thermocouple, DeviceNet, PROFIBUS, and simulator switch module; can be added. The ELC-485APTR easily connects the RS485 port of MVX drive, controllers and other devices.

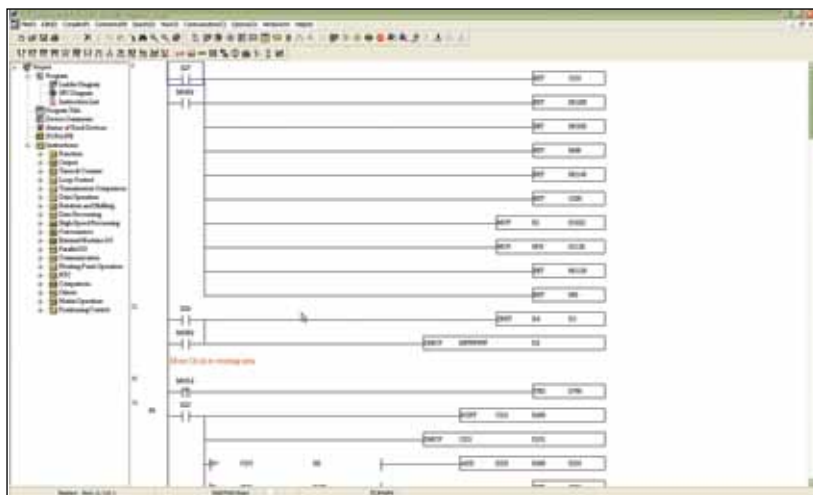

ELC SOFTWARE

- Display registers “in use” and modules attached to the ELC
- Monitor runtime applications; force (except basic), and enter/modify register values
- Wizards aid programming of remote I/O, standard communications, high speed counters, pulse outputs, ELC Link, positioning, interrupts, PIDs, and extension module setup

ELCSoft, software

GRAPHIC PANELS

ELC Graphic Panels are simple to program and easily connect to ELC products. ELC graphic panels make modifying an application quick and easy. ELC graphic panels also connect to Cutler-Hammer® MVX drives, IQMODBUS meters and many other devices. With over 30 objects that can be placed anywhere on the display, these tough panels also communicate with other major controllers. These graphic panels have two serial ports which can be used simultaneously to communicate. Transfer applications to or from these graphic panels using the handy transfer module (ELC-GPXFERMOD). Ten programmable functions keys provide easy to change pages, input numeric values, enter alpha-numeric passwords, set, reset and more. Create alarms, password protect, import bitmaps, and use many different fonts.



ELC-GP02



ELC-GP04

ENVIRONMENTAL RATINGS

TRANSPORTATION AND STORAGE

Temperature: -25 to 70°C
(-13 to 158°F)

Humidity: 5 to 95%

OPERATING

Temperature: 32 to 131°F (0 to 55°C)

Humidity: 50 to 95%

Power Supply Voltage:

ELC: 24 Vdc (-15 to 20%) with DC input reverse polarity protection

Expansion Unit: Supplied by the ELC

Power Consumption:

Insulation Resistance: >5 M @ 500 Vdc, between all inputs/outputs and earth

Grounding: The diameter of the grounding wire cannot be smaller than the wire diameter of terminals L and N (all ELC units should be grounded directly to the ground pole)

Vibration/Shock Resistance:

Standard: IEC1131-2, IEC 68-2-6 (TEST Fc)/IEC1131-2 and IEC 68-2-27 (TEST Ea)

Approx. Weight: 0.158 kg (0.348 lb)

DC INPUT POINT ELECTRICAL

Input Type: DC (SINK or SOURCE)

Input Current: 24 Vdc 5 mA

Active Level:

OFF/ON: Above 16 Vdc

ON/OFF: Below 14.4 Vdc

Response Time: About 10 ms; an adjustment range of 0 to 10,000 ms could be selected through D1020 and D1021

SPECIFICATIONS

ELECTRICAL/EMC

ESD Immunity: 8 kV air discharge

EFT Immunity:

Power Line: 2 kV

Digital I/O: 1 kV

Analog and Communication

I/O: 250 V

Damped-Oscillatory Wave:

Power Line: 1 kV

Digital I/O: 1 kV

RS Immunity: 26 MHz to 1 GHz, 10 V/m

OTHER APPROVALS

Agency Certifications: UL 508, cUL, CE, Class 1, Div 2

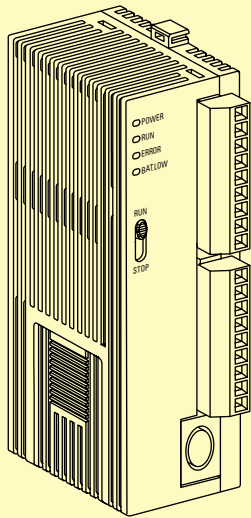

ELC-PB14 Series

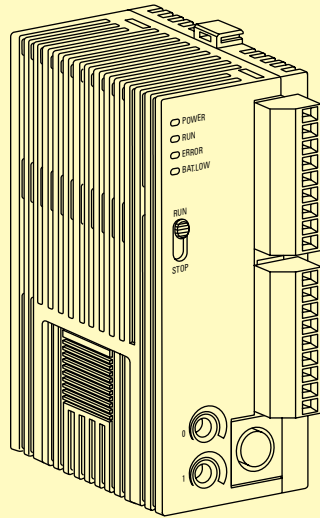

ELC-PC12 Series

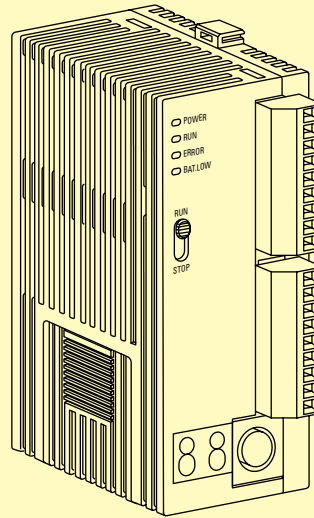

ELC-PA10 Series

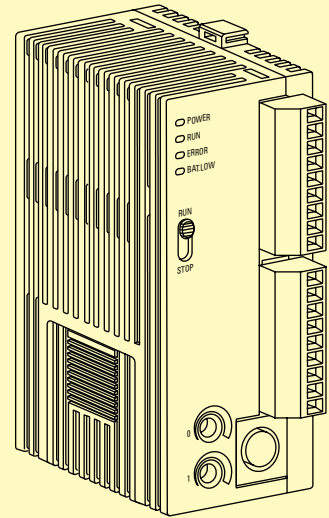

ELC-PH12NNDT

SPECIFICATIONS (CONTINUED)

Maximum I/O: 256 (128 In / 128 out);
any number of modules

I/O Type:

- ELC-PB14 Series:**
14 (8 in/6 out, digital)
- ELC-PC12 Series:**
12 (8 in/4 out, digital)
- ELC-PA10 Series:**
10 (4 in/2 out, digital);
2 in/2 out, analog)
- ELC-PH12NNDT:**
12 (8 in/4 out, digital)

DC In Sink/Source: Yes

Execution Speed: Basic commands—
2 μ seconds min

Program Language: Boolean + ladder
logic + SFC

Program Capacity:

- ELC-PB14 Series:** 3792 Steps
- ELC-PC12 Series, ELC-PA10 Series,
ELC-PH12NNDT:** 7920 Steps

Data Memory Capacity (bits):

- ELC-PB14 Series:** 1280 Bits
- ELC-PC12 Series, ELC-PA10 Series,
ELC-PH12NNDT:** 4096 Bits

Data Memory Capacity (words):

- ELC-PB14 Series:** 744 Words
- ELC-PC12 Series, ELC-PA10 Series,
ELC-PH12NNDT:** 5000 Words

Index Registers:

- ELC-PB14 Series:** 2 Words
- ELC-PC12 Series, ELC-PA10 Series,
ELC-PH12NNDT:** 8 Words

File Memory Capacity:

- ELC-PC12 Series, ELC-PA10 Series,
ELC-PH12NNDT Only:** 1600 Words

Commands:

- ELC-PB14 Series:** 32 Basic/
107 advanced
- ELC-PC12 Series, ELC-PA10 Series,
ELC-PH12NNDT:** 32 Basic/
168 advanced

Floating Point: Yes

SFC Commands:

- ELC-PB14 Series:** 128 Steps
- ELC-PC12 Series, ELC-PA10 Series,
ELC-PH12NNDT:** 1024 Steps

Timers:

- ELC-PB14 Series:** 128 (1 to 100 ms)
- ELC-PC12 Series, ELC-PA10 Series,
ELC-PH12NNDT:** 256 (1 to 100 ms)

Counters:

- ELC-PB14 Series:** 128 (16 bit/
32 bit/up/down)
- ELC-PC12 Series, ELC-PA10 Series,
ELC-PH12NNDT:** 250 (16 bit/
32 bit/up/down)

High Speed Counters:

- ELC-PB14 Series:** 1 (14 modes)
10 K maximum
- ELC-PC12 Series, ELC-PA10 Series,
ELC-PH12NNDT:** 1 (14 modes) 20 kHz
for PA/PC; 100 kHz for PH

Pulse Output:

- ELC-PB14 Series:** 2 channels
10 kHz maximum
- ELC-PC12 Series, ELC-PA10 Series,
ELC-PH12NNDT:** 2 channels, 40 kHz
maximum for PC/PA, 100 kHz for PH

Master Control Loop:

- ELC-PC12 Series, ELC-PA10 Series,
ELC-PH12NNDT Only:** 8 Loops

Subroutines:

- ELC-PB14 Series:** 64 subroutines
- ELC-PC12 Series, ELC-PA10 Series,
ELC-PH12NNDT:** 256 subroutines

Interrupts:

- ELC-PB14 Series:** 6
- ELC-PC12 Series, ELC-PA10 Series,
ELC-PH12NNDT:** 15 (external/time
base/HS CNTR /comm)

Real-time Clock/Calendar:

- ELC-PC12 Series, ELC-PA10 Series,
ELC-PH12NNDT Only:** Built-in

Specialty Expansions Modules:

8 (analog in/analog out/TC/RTD/PT);
modules do not count in total I/O

Serial Ports: 2 (one RS232, one RS485)

Remote I/O:

- ELC-PC12 Series, ELC-PA10 Series,
ELC-PH12NNDT Only:** With 16 other
devices

Run Time Editing:

- ELC-PC12 Series, ELC-PA10 Series,
ELC-PH12NNDT Only:** Yes, also
includes PB

Run/Stop Switch:

- ELC-PC12 Series, ELC-PA10 Series,
ELC-PH12NNDT Only:** Yes, also
includes PB

Removable Terminal Strips:

- ELC-PC12 Series, ELC-PA10 Series,
ELC-PH12NNDT Only:** Yes, also
includes PB

Special Features:

- ELC-PC12 Series:** 2 potentiometers
- ELC-PA10 Series:** Two 7-segment
displays
- ELC-PH12NNDT:** 2 potentiometers

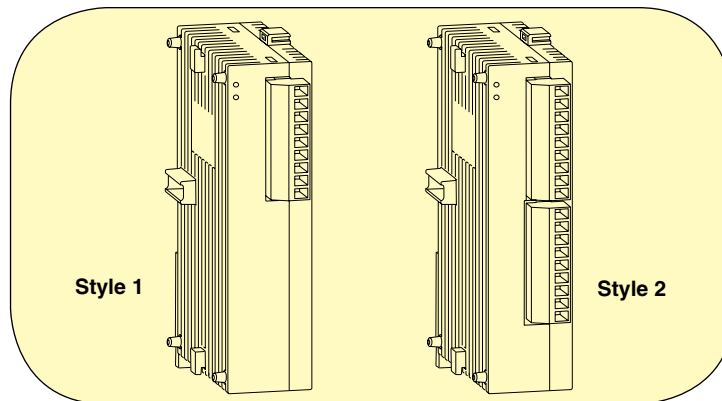

ELC EXPANSION MODULES

MODEL	TYPE	STYLE	INPUTS		OUTPUTS	
			POINTS	TYPE	POINTS	TYPE
ELC-EX08NNAN	AC IN	1	8	120 Vac	0	—
ELC-EX08NNDN	DC IN	1	8	DC Sink or Source	0	—
ELC-EX08NNNR	Relay OUT	1	0	—	8	Relay
ELC-EX08NNDT	IN/OUT Combo	2	4	DC Sink or Source	4	Transistor
ELC-EX08NNNT	Transistor OUT	1	0	—	8	Transistor
ELC-EX06NNNI	High Current Relay OUT	2	0	—	6	Relay (6 A)
ELC-EX08NNDR	IN/OUT Combo	2	4	DC Sink or Source	4	Relay
ELC-EX16NNDR	IN/OUT Combo	2	8	DC Sink or Source	8	Relay
ELC-EX16NNDT	IN/OUT Combo	2	8	DC Sink or Source	8	Transistor

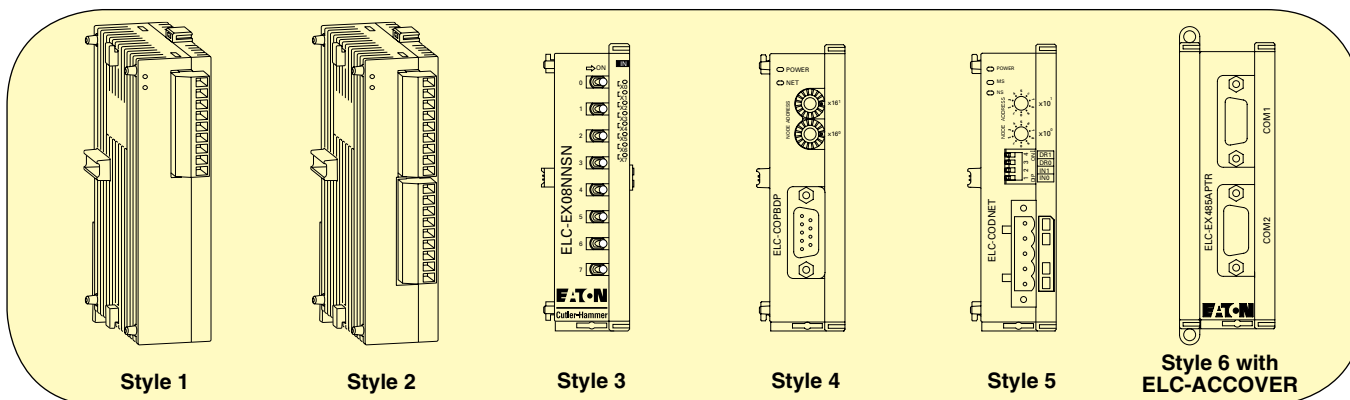

ELC SPECIALTY MODULES

MODEL	TYPE	POWER	STYLE	INPUTS		OUTPUTS	
				POINTS	TYPE	POINTS	TYPE
ELC-AN02NANN	Analog OUT	24 Vdc	1	0	-20 mA~20 mA	2 (12 bits)	0 to 20 mA, 4 to 20 mA 0 to 10V, 2 to 10V
ELC-AN04NANN	Analog OUT		2	0	-10V ~ +10V	4 (12 bits)	
ELC-AN06AANN	Analog Combo		2	4	±10V, ±20 mA	2 (12 bits)	
ELC-AN04ANNN	Analog IN		2	4 (V = 14 bits, I = 11 bits)	±10V, ±20 mA	0	—
ELC-PT04ANNN	PT100		2	4 (V = 14 bits I = 13 bits)	PT100	0	
ELC-TC04ANNN	Thermocouple		2	4	J, K, R, S, T	0	
ELC-EX08NNSN	Switch Input	24 Vdc	3	8	Switch	0	Digital
ELC-COPBDP	PROFIBUS DP	24 Vdc	4	32	Digital	32	Digital
ELC-CODNET	DeviceNet	24 Vdc	5	32	Digital	32	Digital
ELC-485APTR	RS485 Easy Connect	N/A	6	0	—	0	—



To Order Visit omega.com/elc_plc for Pricing and Details

MODEL NO.	DESCRIPTION	INPUT			OUTPUT		
		AC	DC	ANALOG	RELAY	TRANSISTOR	ANALOG
ELC-PB14NNDR	14 I/O PB Series		8		6		
ELC-PB14NNDT	14 I/O PB Series		8			6	
ELC-PC12NNAR	12 I/O PC Series	8			4		
ELC-PC12NNDR	12 I/O PC Series		8		4		
ELC-PH12NNDT	12 I/O PH Series		8			4	
ELC-PA10AADR	10 I/O PA Series		4	2	2		2
DIGITAL I/O EXPANSION MODULES							
MODEL NO.	DESCRIPTION	TYPE	INPUT		OUTPUT		
			AC	DC	RELAY	TRANSISTOR	
ELC-EX06NNNI	6 I/O expansion	6 A outputs				6	
ELC-EX08NNAN	8 I/O expansion	AC in	8				
ELC-EX08NNDN	8 I/O expansion	DC in		8			
ELC-EX08NNNR	8 I/O expansion	Relay out				8	
ELC-EX08NNDR	8 I/O expansion	in/out combo			4	4	
ELC-EX16NNDR	16 I/O expansion	in/out combo			8	8	
ELC-EX08NNDT	8 I/O expansion	in/out combo			4	4	
ELC-EX08NNNT	8 I/O expansion	Transistor out				8	
ELC-EX16NNDT	16 I/O expansion	in/out combo			8	8	
ELC-EX08NNSN	8 I/O expansion	Switch in			8		
ANALOG I/O MODULES							
MODEL NO.	DESCRIPTION	ANALOG IN			ANALOG OUT		
ELC-AN04ANNN	4 I/O analog in	4					
ELC-AN02NANN	2 I/O analog out				2		
ELC-AN04NANN	4 I/O analog out				4		
ELC-AN06AANN	6 I/O analog in/out	4			2		
ELC-TC04ANNN	4 I/O thermocouple J, K, R, S, T	4					
ELC-PT04ANNN	4 I/O platinum RTD, PT100	4					
ACCESSORIES							
MODEL NO.	DESCRIPTION						
ELC-CODNET	ELC expansion module for DeviceNet e						
ELC-COPBDP	ELC expansion module for ProfibusDP slave						
ELC-MC01	ELC motion control for 1 axis, use with ELC-PHNNDT						
ELC-ACPGMXFR	Program transfer module for ELC controllers						
ELC-GP02	ELC graphics panel, monochrome, 160x32 pixels, 10 keys						
ELC-GP04	ELC graphics panel, monochrome, 128x64 pixels, 10 keys						
ELC-GPXFERMOD	ELC graphics panel transfer module						
ELC-PS01	ELC power supply, 24 W, 1 A						
ELC-PS02	ELC power supply, 48 W, 2 A						
ELCSOFT	ELC programming software for ELC controllers						
ELCSOFTGP	ELC programming software for ELC graphics panels						
ELC-CBPCELC1	Cable to connect a PC or a GP unit to ELC, 1 m (3.3') (DB9 pin female to 8 pin DIN)						
ELC-CBPCELC3	Cable to connect a PC or a GP unit to ELC, 3 m (9.8') (DB9 pin female to 8 pin DIN)						

Ordering Example: ELC-PB14NNDR, ELCSOFT.