



User's Guide



Shop online at

omega.com[®]

Ω OMEGA[®]

omega.com

e-mail: info@omega.com

For latest product manuals:
omegamannual.info

ISO 9001
CERTIFIED
CORPORATE QUALITY

STAMFORD, CT

ISO 9001
CERTIFIED
CORPORATE QUALITY

MANCHESTER, UK

**Series FTB-1400-MD
FTB-1400-RD
FTB-1400-SD
Flow Monitor - Simplified Version**

omega.com[®]

Ω OMEGA[®]

OMEGAnet[®] Online Service
omega.com

Internet e-mail
info@omega.com

Servicing North America:

U.S.A.:

ISO 9001 Certified

One Omega Drive, Box 4047
Stamford, CT 06907-0047
Tel: (203) 359-1660
FAX: (203) 359-7700
e-mail: info@omega.com

Canada:

976 Bergar
Laval (Quebec) H7L 5A1, Canada
Tel: (514) 856-6928
FAX: (514) 856-6886
e-mail: info@omega.ca

For immediate technical or application assistance:

U.S.A. and Canada: Sales Service: 1-800-826-6342/1-800-TC-OMEGA[®]
Customer Service: 1-800-622-2378/1-800-622-BEST[®]
Engineering Service: 1-800-872-9436/1-800-USA-WHEN[®]

Mexico:

En Español: (001) 203-359-7803
e-mail: espanol@omega.com
FAX: (001) 203-359-7807
info@omega.com.mx

Servicing Europe:

Czech Republic:

Frystatska 184, 733 01 Karviná, Czech Republic
Tel: +420 (0)59 6311899
FAX: +420 (0)59 6311114
Toll Free: 0800-1-66342
e-mail: info@omegashop.cz

Germany/Austria:

Daimlerstrasse 26, D-75392 Deckenpfronn, Germany
Tel: +49 (0)7056 9398-0
FAX: +49 (0)7056 9398-29
Toll Free in Germany: 0800 639 7678
e-mail: info@omega.de

United Kingdom:

ISO 9001 Certified

One Omega Drive, River Bend Technology Centre
Northbank, Irlam, Manchester
M44 5BD United Kingdom
Tel: +44 (0)161 777 6611
FAX: +44 (0)161 777 6622
Toll Free in United Kingdom: 0800-488-488
e-mail: sales@omega.co.uk

It is the policy of OMEGA Engineering, Inc. to comply with all worldwide safety and EMC/EMI regulations that apply. OMEGA is constantly pursuing certification of its products to the European New Approach Directives. OMEGA will add the CE mark to every appropriate device upon certification.

The information contained in this document is believed to be correct, but OMEGA accepts no liability for any errors it contains, and reserves the right to alter specifications without notice.

WARNING: These products are not designed for use in, and should not be used for, human applications.

TABLE OF CONTENTS

Introduction	4
Specifications.....	5
Operating the Monitor	6
Programming Mode	7
Programming	7
K-factor	8
Password.....	9
Totalizer.....	10
Battery Replacement	10
Additional Input Options	11
Wiring Diagram.....	12
Programming Menu	13
Mounting Options	14
Troubleshooting.....	16
Part Numbering Information	17
Installation Drawing.....	18
Statement of Warranty	19

INTRODUCTION

The FTB-1400 Flow Monitor is a state-of-the-art, digital signal processing flow monitor, designed to provide the user with exceptional flexibility at a very affordable price. Though designed for use with Omega FTB-1400 flow meters, this display can be used with almost any flow meter producing a low amplitude AC output or contact closure signal(s).

This flow monitor is capable of accepting a low-level frequency input for calculating flow rate and total. These calculations can then be displayed in the desired units of measurement. All FTB-1400 Flow Monitors come pre-calibrated, from the factory, if ordered with an Omega FTB-1400 flow meter. If required, however, it can easily be re-configured in the field. The monitor's large 8 digit by .75" numeric liquid crystal display makes extended range viewing practical. The second 8 digit by .38" alphanumeric display provides for selectable units viewing in run mode and prompts for variables in program mode. Finally, the user can choose between displaying rate, total, or alternating between both rate and total.

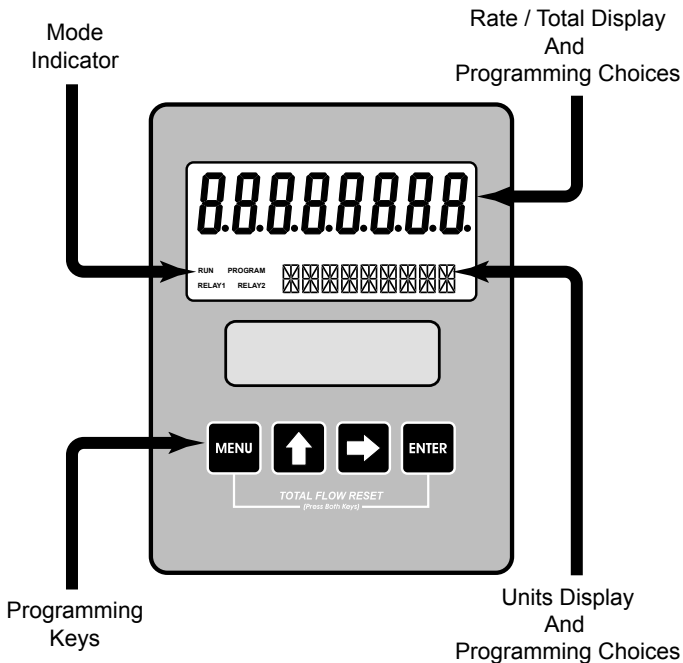

FIGURE 1
Flow Monitor

SPECIFICATIONS

Power Supply Options:

1 "D" size 1.5 volt alkaline battery

Alphanumeric Rate and Total Display:

8 digit, .75" high numeric display

8 character, .38" high alphanumeric display

Fixed or toggle modes of operation for flow rate and totalizer display

Accuracy:

±0.1%

Temperature Drift: 50ppm/°C (maximum)

Mounting Classification:

Meter Mount: Type 4X Enclosure

Remote Mount: Type 4X Enclosure

Swivel Mount: Type 4X Enclosure

Environmental:

Operating Temperature: -22 °F to +158 °F (-30 °C to +70 °C)

Humidity: 0-90% Non-condensing

Inputs:

Magnetic Pick-up Input

Frequency Range: 0 to 3500 Hz

Trigger Sensitivity: 30 mV p-p

Over Voltage Protected: ±30 VDC

Outputs:

Opto-isolated Open Collector Transistor

Maximum Voltage: 30 VDC

Pulse width: 20mS/Max rate 20Hz

Current (ON state): 0.9V drop @ 5.0 mA or 0.7V drop @ 0.1 mA

OPERATING THE MONITOR

The monitor has two modes of operation referred to as the **RUN** mode and the **PROGRAM** mode. Both the run mode and the program mode display screen enunciators confirming the state of the monitor. A quick glance at the lower left-hand corner of the LCD screen will confirm operating status. Normal operation will be in the **RUN** mode. To access the program mode, press the **MENU** button until the first programming screen is displayed. After programming the display with the necessary information, a lock out feature can be turned on to prevent unauthorized access or changing the meter's setup parameters.

BASIC PROGRAMMING MODE

Keys:

MENU – Switches to Program mode

UP Arrow – Scrolls forward through the parameter choices and increments numeric variables

RIGHT Arrow – Scrolls backward through the parameter choices and moves the active digit to the right

ENTER – Used to save programming information, advance to the next programming parameter, and in the reset process

Modes:

RUN – Normal operating mode

PROGRAM – Used to program variables into the display

If your monitor was ordered with an Omega FTB-1400 flow meter, the two components ship from the factory calibrated as a set. If the monitor is a replacement, the turbine's K-factor has changed, or the monitor is being used with some other pulse generating device, programming will be necessary.

PROGRAMMING USING PULSE OUTPUT TURBINE FLOW METERS

Each turbine flow meter is shipped with either a K-factor value or frequency data. If frequency data is provided, the data must be converted to a K-factor before programming the monitor. K-factor information, when supplied, can usually be found on the neck of the flow meter or stamped on the body. The K-factor represents the number of pulses per unit of volume. The K-factor will be needed to program the monitor readout.

ENTER PROGRAM MODE – Change to program mode by pressing the MENU button once. The mode indicator will change from RUN to PROGRAM.

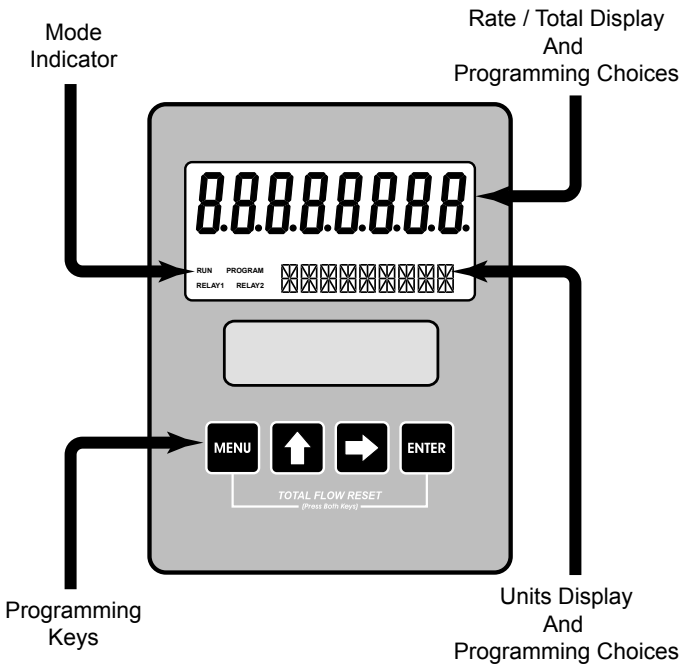

FIGURE 2
Flow Monitor

SELECT THE METER SIZE – At the METER prompt, press the UP or RIGHT arrow keys to select the bore size of your meter. Press ENTER button once to save meter size choice and advance to the K-factor units selection.

NOTE: *The meter connection size and the bore size are different. For example, many of the 1" NPT turbines have bore sizes that range from 3/8" up to 1". Be sure to use the correct bore size or the meter will report incorrect flows and totals.*

ENTER THE METER'S K-FACTOR UNIT – Directly after the METER size is selected, the display's K-factor unit must be chosen. Use the UP arrow key to select your K-factor unit. For meters calibrated in gallons, use PUL/GAL (pulses per gallon); for meters calibrated in cubic meters, use PUL/M3 (pulses per cubic meter), etc. Press ENTER to save the K-factor unit and advance to the next parameter.

NOTE: *Unless otherwise specified, Omega FTB-1400 turbine flow meters are supplied with K-factors measured in pulses per gallon (PUL/GAL) which will automatically convert to your desired units of measure.*

NOTE: *The K-factor supplied with the meter or calculated from calibration data will be needed to complete next step.*

ENTER THE METER'S K-FACTOR – To change the K-FACTOR value, use the RIGHT arrow key and select the position of the number that you wish to change. Using the UP arrow key, increment the display digit until it matches the meter's K-factor digit. Repeat this process until all K-factor digits have been entered. Press ENTER once to save the actor and advance to the RATE/TOTAL units selection.

SELECT THE RATE/TOTAL UNITS OF MEASURE – The monitor allows the choice of five common rate/total units. The monitor shows the current rate/total unit. If the current selection is correct, press the ENTER key once to advance to the next parameter. To change to an alternate unit, use the arrow keys to scroll to the desired rate unit and press ENTER to save the choice.

Selection	Rate	Total
GPM/GAL	Gallons per Minute	Gallons
LPM/LIT	Liters per Minute	Liters
M3PH/M3	Cubic Meters per Hour	Cubic Meters
M3PD/M3	Cubic Meters per Day	Cubic Meters
BPD/BBL	Oil Barrels per Day	Oil Barrels

NOTE: *The total unit's output multiplier cannot be modified in the Simplified program level. This option is reserved in the Advanced program level.*

SELECT THE DISPLAY FUNCTION – The monitor can display RATE or TOTAL or alternate between BOTH rate and total. If the current selection is correct, press the ENTER key to advance to the next parameter. To change to an alternate display mode, use the arrow keys to scroll to the desired display mode and press ENTER to save the choice.

A TEST function is also available in the Display Function sub-menu. With the test function selected, the display acts like a frequency counter and displays the raw input frequency being supplied to the frequency input terminals. This is very useful when troubleshooting flow problems.

TOTALIZER PULSE OUTPUT – The pulse output parameter can be either enabled or disabled. When enabled this output generates 20mS duration pulse for every time the least significant digit of the totalizer increments. The amplitude of the pulse is dependent on the voltage level of the supply connected to the pulse output and is limited to a maximum 30 VDC.

PASSWORD – Password protection prevents unauthorized users from changing programming information. Initially, the password is set to all zeros. To change the password, simply enter any 4 digit code using the arrow keys as previously described to enter the password value. Pressing ENTER once will store the password and take you back to the RST PSWD screen.

NOTE: *This password will allow the operator to manually reset totals.*

RST PSWD – The reset password screen allows the operator to enter any 4 digit code for the manual reset totals function.

NOTE: *This reset password code will not allow the operator to enter the programming mode.*

RESET TOTAL – To reset the monitor total display, in run mode press the MENU and ENTER simultaneously until TOTAL RST starts to flash. The TOTAL RST will stop flashing and the display will return to the run mode at the conclusion of the reset procedure.

STORE TOTAL – The current total can be manually stored in the monitor's flash memory. This procedure may be desirable prior to replacing the battery. Press and hold the ENTER key for 2 seconds. The display will respond with a flashing TOTALSVD and then return to the run mode.

AUTOMATIC STORE TOTAL – The monitor is equipped with a store total feature that works automatically, saving the current total to flash memory once per hour and just before a low battery condition turns the unit off.

BATTERY REPLACEMENT

Battery powered monitors use a single 1.5V, "D" size, alkaline battery. When replacement is necessary, use a clean fresh battery to ensure continued trouble-free operation. It is recommended that the total be saved to memory before the battery is removed. (See STORE TOTAL above.)

Unscrew the two captive screws on the front panel to gain access to the battery. Replace the battery being sure to observe the proper polarity, and then re-fasten the front panel.

ADDITIONAL INPUT OPTIONS

The FTB-1400 Flow Monitor is capable of receiving magnetic pick-up input (small signal sine wave) or a contact closure input (pulse). Since Omega FTB-1400 turbine flow meters utilize a magnetic pick-up, the FTB-1400 Flow Monitor is shipped configured for magnetic pick-up input. To change to a contact closure input, remove JP2 from the top two pins and jumper them to the bottom two pins. See **Figure 3** on page 12.

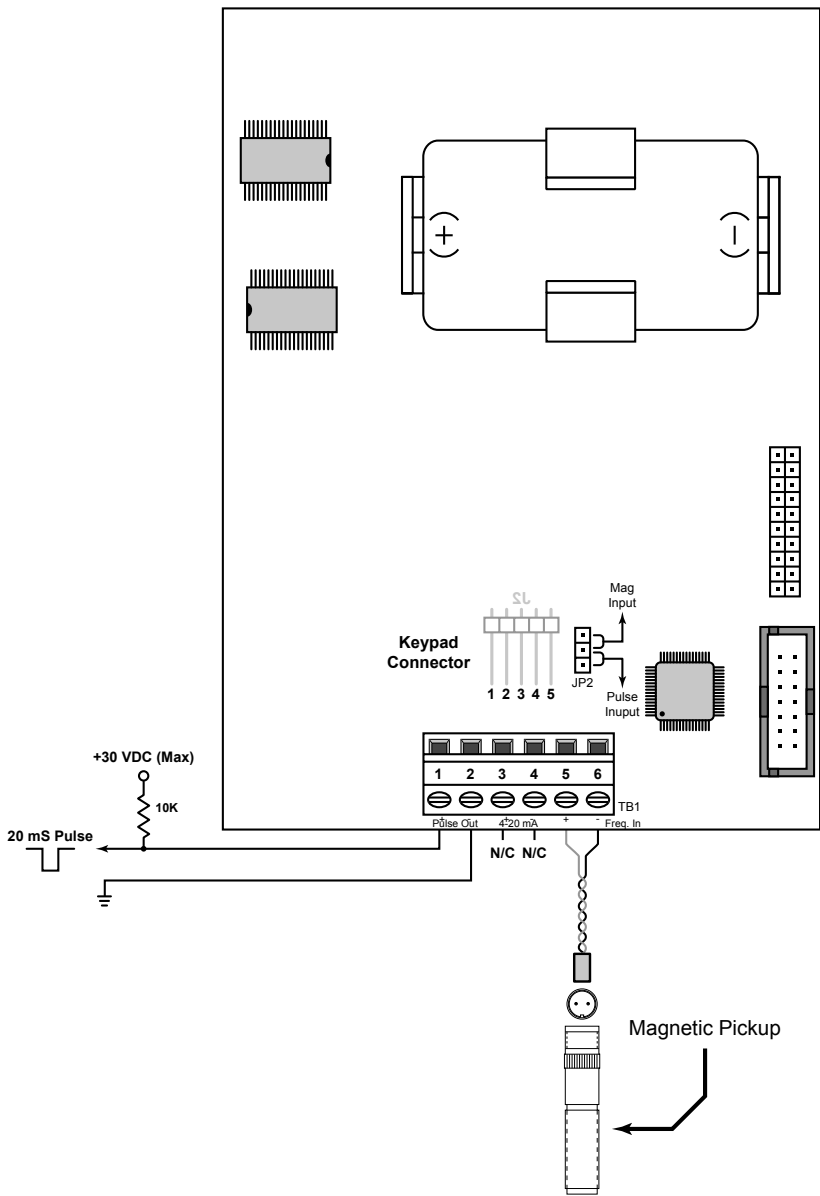

FIGURE 3
Wiring Diagram

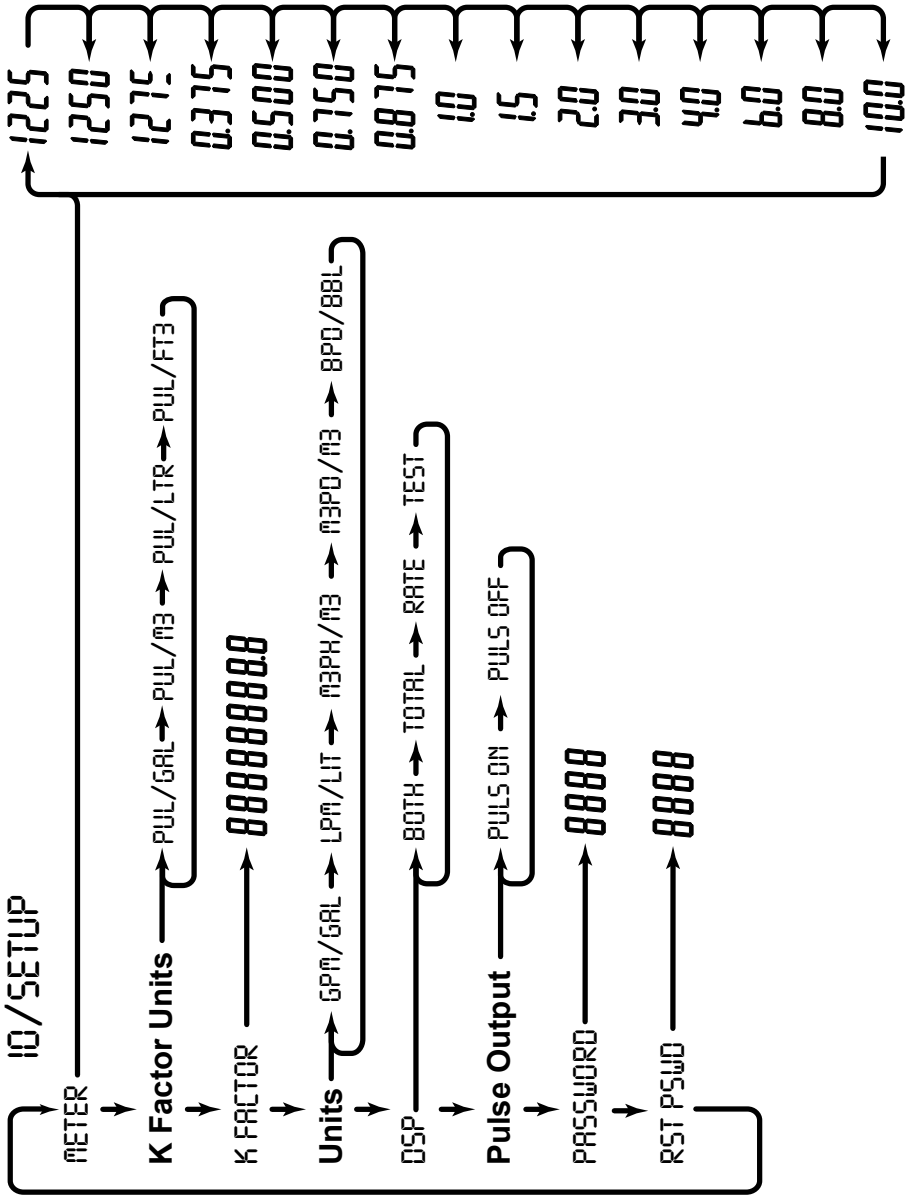
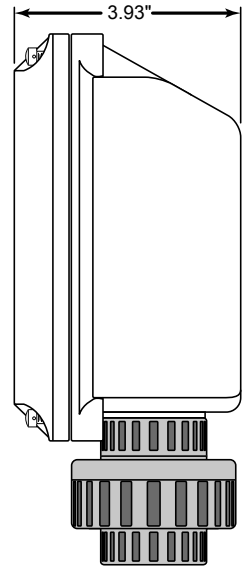
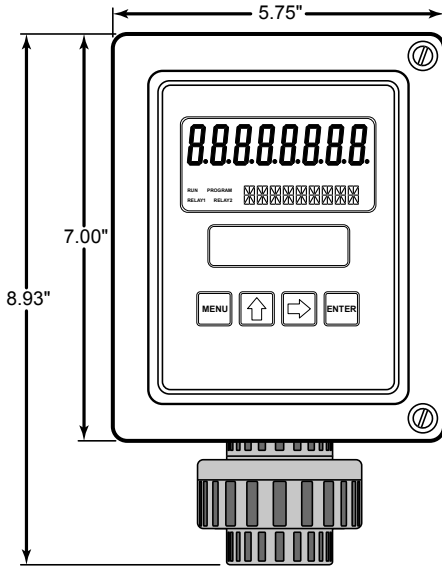
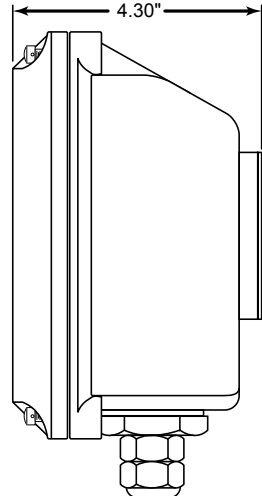
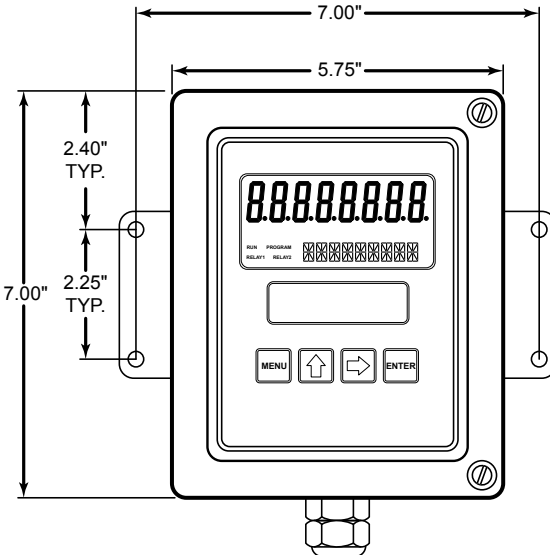

FIGURE 4
Basic Programming Menu

MOUNTING OPTIONS



METER DISPLAY



REMOTE DISPLAY

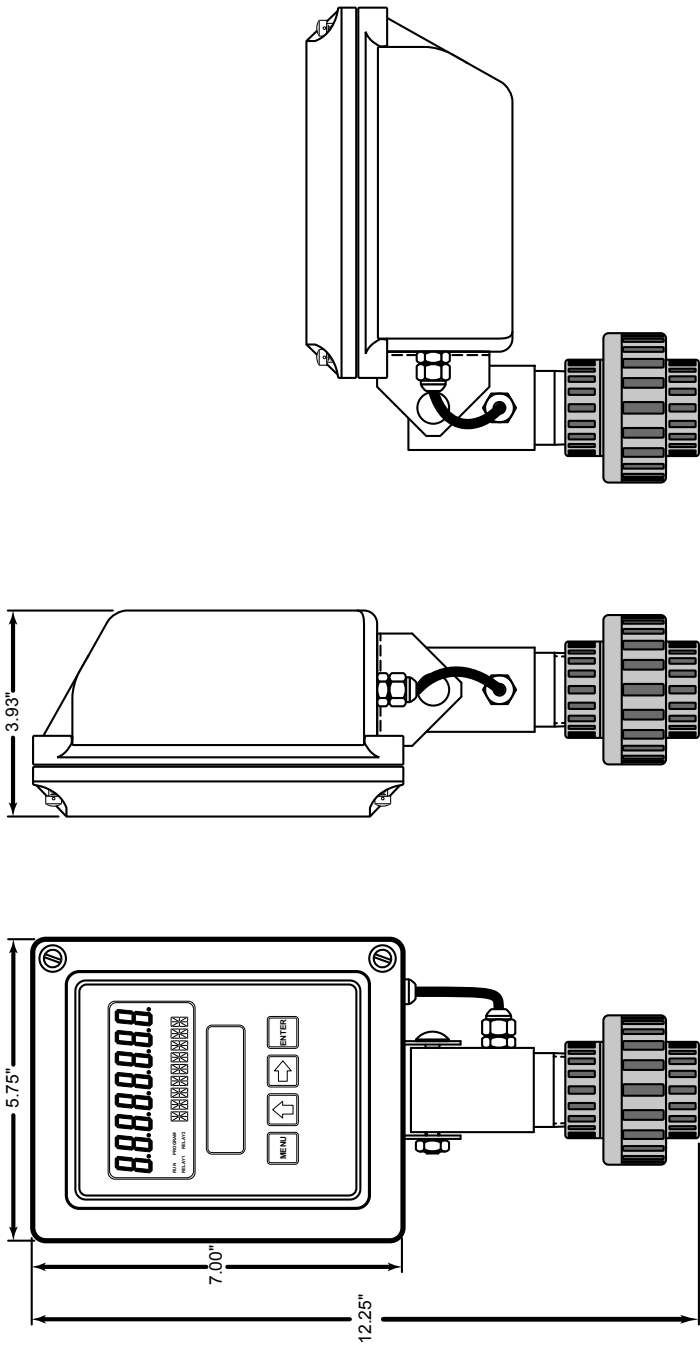

SWIVEL MOUNT

TROUBLESHOOTING GUIDE

Trouble	Remedy
No LCD Display	<ul style="list-style-type: none"> • Check battery voltage. Should be 1.5 Vdc. Replace if low or bad.
No Rate or Total Displayed	<ul style="list-style-type: none"> • Check connection from meter pick-up to display input terminals. • Check turbine meter rotor for debris. Rotor should spin freely. • Check programming of flow monitor.
Flow Rate Display Interprets Reading Constantly	<ul style="list-style-type: none"> • This is usually an indication of external noise. Keep all AC wires separate from DC wires. • Check for large motors close to the meter pick-up. • Check for radio antenna in close proximity. • Try disconnecting the pick-up from the monitor pig tail. This should stop the noise.
Flow Rate Indicator Bounces	<ul style="list-style-type: none"> • This usually indicates a weak signal. Replace pick-up and/or check all connections. • Examine K-factor.

DEFAULT K-FACTOR VALUES

Meter Size	Default K-factor	Lower Limit	Upper Limit
0.375	20,000	16,000	24,000
0.500	13,000	10,400	15,600
0.750	2,750	2,200	3,300
0.875	2,686	2,148	3,223
1.000	870.0	696.0	1,044
1.500	330.0	264.0	396.0
2.000	52.0	41.6	62.0
3.000	57.0	45.6	68.0
4.000	29.0	23.2	35.0
6.000	7.0	5.6	8.0
8.000	3.0	2.4	4.0
10.000	1.6	1.3	2.0

PART NUMBERING INFORMATION

FTB - 1400 - X D

└─ **Mounting Style**

- M** - Meter Mount
- R** - Remote Mount
- S** - Swivel Mount

REPLACEMENT PARTS

Component	Part Number
Keypad	B260713
Battery	B280601
Battery Tie Wrap	B228036
Pick-up Cable	B222-121
Desiccant Bag	B260630
PVC Union	B220016
PVC Reducer Bushing	B220056
Rubber Washer	B228207
Steel Lock Washer	B220018
PCB Shield (battery units)	B280603
Desiccant Shield	B280680
Cord Grip	B220103

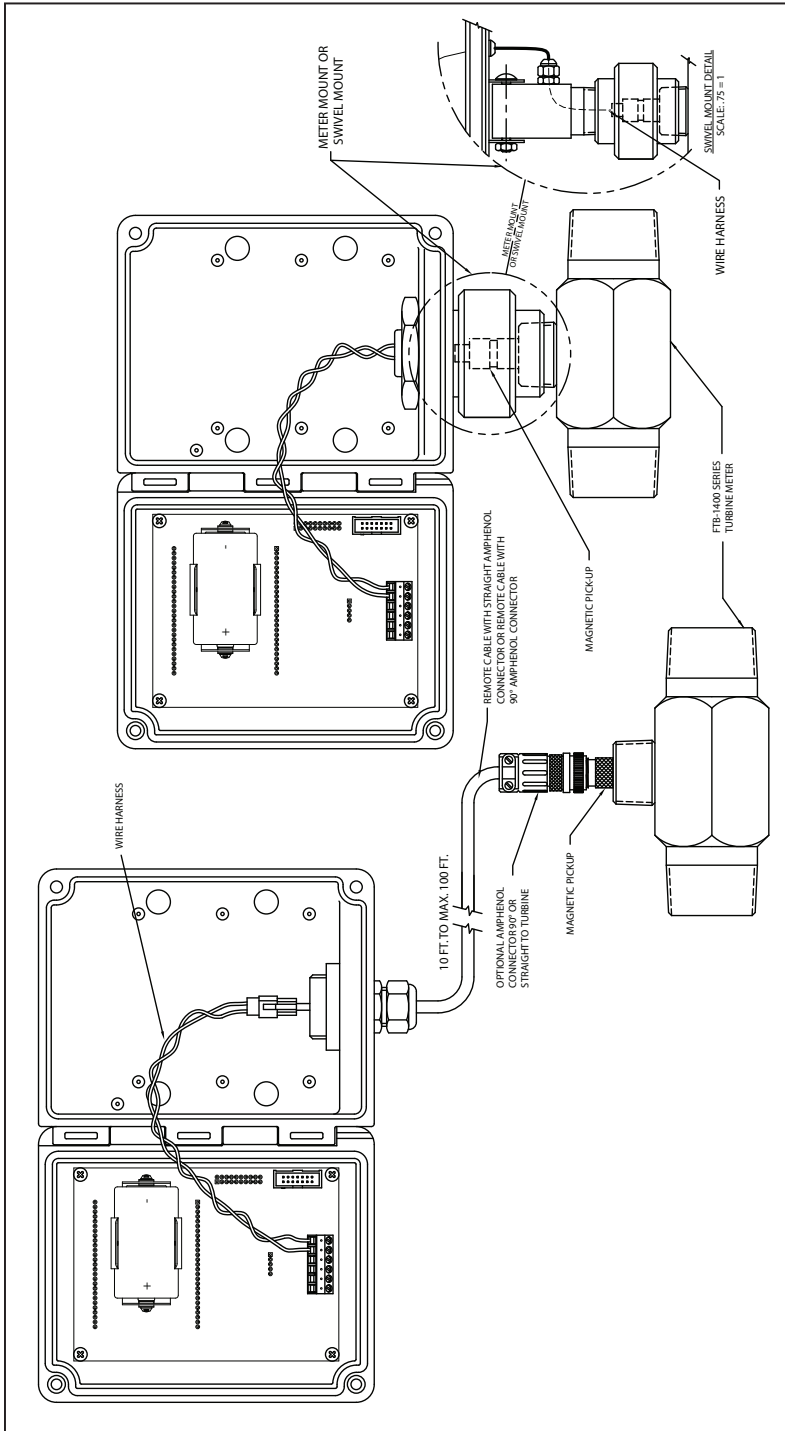

INSTALLATION DRAWING

WARRANTY/DISCLAIMER

OMEGA ENGINEERING, INC. warrants this unit to be free of defects in materials and workmanship for a period of **13 months** from date of purchase. OMEGA's WARRANTY adds an additional one (1) month grace period to the normal **one (1) year product warranty** to cover handling and shipping time. This ensures that OMEGA's customers receive maximum coverage on each product.

If the unit malfunctions, it must be returned to the factory for evaluation. OMEGA's Customer Service Department will issue an Authorized Return (AR) number immediately upon phone or written request. Upon examination by OMEGA, if the unit is found to be defective, it will be repaired or replaced at no charge. OMEGA's WARRANTY does not apply to defects resulting from any action of the purchaser, including but not limited to mishandling, improper interfacing, operation outside of design limits, improper repair, or unauthorized modification. This WARRANTY is VOID if the unit shows evidence of having been tampered with or shows evidence of having been damaged as a result of excessive corrosion; or current, heat, moisture or vibration; improper specification; misapplication; misuse or other operating conditions outside of OMEGA's control. Components in which wear is not warranted, include but are not limited to contact points, fuses, and triacs.

OMEGA is pleased to offer suggestions on the use of its various products. However, OMEGA neither assumes responsibility for any omissions or errors nor assumes liability for any damages that result from the use of its products in accordance with information provided by OMEGA, either verbal or written. OMEGA warrants only that the parts manufactured by the company will be as specified and free of defects. OMEGA MAKES NO OTHER WARRANTIES OR REPRESENTATIONS OF ANY KIND WHATSOEVER, EXPRESSED OR IMPLIED, EXCEPT THAT OF TITLE, AND ALL IMPLIED WARRANTIES INCLUDING ANY WARRANTY OF MERCHANTABILITY AND FITNESS FOR A PARTICULAR PURPOSE ARE HEREBY DISCLAIMED. LIMITATION OF LIABILITY: The remedies of purchaser set forth herein are exclusive, and the total liability of OMEGA with respect to this order, whether based on contract, warranty, negligence, indemnification, strict liability or otherwise, shall not exceed the purchase price of the component upon which liability is based. In no event shall OMEGA be liable for consequential, incidental or special damages.

CONDITIONS: Equipment sold by OMEGA is not intended to be used, nor shall it be used: (1) as a "Basic Component" under 10 CFR 21 (NRC), used in or with any nuclear installation or activity; or (2) in medical applications or used on humans. Should any Product(s) be used in or with any nuclear installation or activity, medical application, used on humans, or misused in any way, OMEGA assumes no responsibility as set forth in our basic WARRANTY/DISCLAIMER language, and, additionally, purchaser will indemnify OMEGA and hold OMEGA harmless from any liability or damage whatsoever arising out of the use of the Product(s) in such a manner.

RETURN REQUESTS/INQUIRIES

Direct all warranty and repair requests/inquiries to the OMEGA Customer Service Department. BEFORE RETURNING ANY PRODUCT(S) TO OMEGA, PURCHASER MUST OBTAIN AN AUTHORIZED RETURN (AR) NUMBER FROM OMEGA'S CUSTOMER SERVICE DEPARTMENT (IN ORDER TO AVOID PROCESSING DELAYS). The assigned AR number should then be marked on the outside of the return package and on any correspondence.

The purchaser is responsible for shipping charges, freight, insurance and proper packaging to prevent breakage in transit.

FOR **WARRANTY** RETURNS, please have the following information available BEFORE contacting OMEGA:

1. Purchase Order number under which the product was PURCHASED,
2. Model and serial number of the product under warranty, and
3. Repair instructions and/or specific problems relative to the product.

FOR **NON-WARRANTY** REPAIRS, consult OMEGA for current repair charges. Have the following information available BEFORE contacting OMEGA:

1. Purchase Order number to cover the COST of the repair,
2. Model and serial number of the product, and
3. Repair instructions and/or specific problems relative to the product.

OMEGA's policy is to make running changes, not model changes, whenever an improvement is possible. This affords our customers the latest in technology and engineering.

OMEGA is a registered trademark of OMEGA ENGINEERING, INC.

© Copyright 2008 OMEGA ENGINEERING, INC. All rights reserved. This document may not be copied, photocopied, reproduced, translated, or reduced to any electronic medium or machine-readable form, in whole or in part, without the prior written consent of OMEGA ENGINEERING, INC.

Where Do I Find Everything I Need for Process Measurement and Control? **OMEGA...Of Course!**

Shop online at omega.comSM

TEMPERATURE

- ☑ Thermocouple, RTD & Thermistor Probes, Connectors, Panels & Assemblies
- ☑ Wire: Thermocouple, RTD & Thermistor
- ☑ Calibrators & Ice Point References
- ☑ Recorders, Controllers & Process Monitors
- ☑ Infrared Pyrometers

PRESSURE, STRAIN AND FORCE

- ☑ Transducers & Strain Gages
- ☑ Load Cells & Pressure Gages
- ☑ Displacement Transducers
- ☑ Instrumentation & Accessories

FLOW/LEVEL

- ☑ Rotameters, Gas Mass Flowmeters & Flow Computers
- ☑ Air Velocity Indicators
- ☑ Turbine/Paddlewheel Systems
- ☑ Totalizers & Batch Controllers

pH/CONDUCTIVITY

- ☑ pH Electrodes, Testers & Accessories
- ☑ Benchtop/Laboratory Meters
- ☑ Controllers, Calibrators, Simulators & Pumps
- ☑ Industrial pH & Conductivity Equipment

DATA ACQUISITION

- ☑ Data Acquisition & Engineering Software
- ☑ Communications-Based Acquisition Systems
- ☑ Plug-in Cards for Apple, IBM & Compatibles
- ☑ Datalogging Systems
- ☑ Recorders, Printers & Plotters

HEATERS

- ☑ Heating Cable
- ☑ Cartridge & Strip Heaters
- ☑ Immersion & Band Heaters
- ☑ Flexible Heaters
- ☑ Laboratory Heaters

ENVIRONMENTAL MONITORING AND CONTROL

- ☑ Metering & Control Instrumentation
- ☑ Refractometers
- ☑ Pumps & Tubing
- ☑ Air, Soil & Water Monitors
- ☑ Industrial Water & Wastewater Treatment
- ☑ pH, Conductivity & Dissolved Oxygen Instruments