

2 YEAR
WARRANTY

NIST

Ω OMEGA™ **User's Guide**



***Shop online at
omega.com***

***e-mail: info@omega.com
For latest product manuals:
www.omegamanual.info***

BB702 **Blackbody Calibrator**



omega.com info@omega.com

Servicing North America:

**U.S.A.
Headquarters:**

Omega Engineering, Inc.

Toll-Free: 1-800-826-6342 (USA & Canada only)

Customer Service: 1-800-622-2378 (USA & Canada only)

Engineering Service: 1-800-872-9436 (USA & Canada only)

Tel: (203) 359-1660

Fax: (203) 359-7700

e-mail: info@omega.com

For Other Locations Visit omega.com/worldwide

Table of Contents

Section	Page
Section 1 Introduction	1-1
1.1 Precautions	1-1
1.2 Safety Warnings and IEC Symbols	1-1
1.3 General Description	1-2
Section 2 Installation	2-1
2.1 Unpacking and Inspection	2-1
2.2 Mounting	2-1
2.3 Ambient Temperature	2-1
2.4 Power Connection	2-2
Section 3 Operation	3-1
3.1 Front Panel Controls and Indicators	3-1
3.2 Back Panel Connections	3-2
3.3 Changing the Temperature Setpoint	3-3
3.4 Changing the Controller Parameters	3-3
3.5 Heat Up / Cool Down Cycle Times	3-5
3.6 Overheat Reset Switch	3-5
Section 4 Serial Communication	4-1
Section 5 Maintenance	5-1
5.1 Calibration	5-1
5.2 Cleaning	5-1
5.2.1 Main Body	5-1
5.2.2 Target Plate	5-1
5.2.3 Fan	5-1
5.3 Fuse Replacement	5-1
Section 6 Reference Probe	6-1
Section 7 Specifications	7-1
Section 8 Troubleshooting Guide	8-1
Section 9 Glossary of Terms Used in This Manual	9-1
Section 10 The OMEGA Family of Blackbody Calibrators	10-1

Table of Figures

Figure	Description	Page
1	I.E.C. Symbols	1-2
2	Maximum Setpoint Temperature Limits	2-2
3	Front Panel	3-1
4	Back Panel	3-2
5	Menu Hierarchy Showing Factory Default Settings	3-4
6	Programming Procedure	3-4
7	Heat Up / Cool Down Cycle Time Table	3-5
8	Connecting the BB702 to a Computer's Serial Port	4-1
9	Internal Reference Probe Connections	6-1

Section 1 - Introduction

Your BB700 Series Blackbody Calibration Source has been designed for ease of use and reliability whenever you have the need to test or calibrate non-contact infrared temperature instruments. It is important that you read this manual completely and follow all safety precautions before operating this instrument.

1.1 Precautions

- Follow all safety precautions and operating instructions outlined in this manual. If this instrument is not used in a manner specified by the manual, the protection provided by the equipment may be impaired.
- Never leave your calibrator unattended when in use.
- Keep out of reach of all children.
- Never touch the target plate when hot.
- Never place any object within 3 inches of the cavity opening when hot.
- Do not operate in flammable or explosive environments.
- Never operate with a power cord other than the one provided with your unit.
- Check that the power cord is not cracked, frayed or damaged before connecting to device and powering up.
- Remove and or disconnect main power before attempting any maintenance or fuse replacement.
- Do not connect and or operate this unit to a non-grounded, non-polarized outlet or power source.
- Do not connect the serial port or reference probe port to equipment with exposed, hazardous, live voltages.
- Any connections to the serial port or reference port should be made with Class II insulation or better.
- Protect from moisture or rain.



NOTE:

There are no user serviceable parts inside your unit. Attempting to repair or service your unit may void your warranty.

1.2 Safety Warnings and IEC Symbols

This device is marked with international safety and hazard symbols in accordance with IEC 1010. It is important to read and follow all precautions and instructions in this manual before operating or commissioning this device as it contains important information relating to safety and EMC. Failure to follow all safety precautions may result in injury and or damage to your calibrator. Use of this device in a manner not specified by the manufacturer may impair protection provided within the unit.





IEC symbols	Description
	Caution, risk of electric shock
	Caution, refer to accompanying documents
	Caution, hot surface
	230 VAC @50/60Hz (European Models) 115 VAC @50/60Hz (Domestic Models)

Figure 1. IEC symbols

1.3 General Description

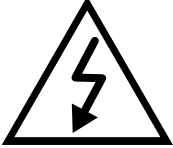
The Model BB702 is a portable, rugged, bench-top, blackbody calibration source with a built-in precision PID digital controller. The calibrator is used to test and calibrate infrared pyrometers. The 2.5 inch Diameter target plate has an emissivity of 0.95 and can be set to any temperature between ambient +11 to 215°C (ambient +20 to 420°F).

Section 2 - Installation

2.1 Unpacking

Remove the packing list and verify that you have received all your equipment. If you have any questions about the shipment, please call our Customer Service Department.

We can also be reached on the Internet.

When you receive the shipment, inspect the container and equipment for any signs of damage. Note any evidence of rough handling in transit. Immediately report any damage to the shipping agent.

NOTE:

The carrier will not honor any damage claims unless all shipping material is saved for inspection. After examining and removing contents, save packing material and carton in the event reshipment is necessary.

The following items are supplied in the box:

- BB702 Blackbody Calibration Source
- User's Manual
- Calibration Certificate
- Power Cord
- Reference Port Cord Plug Connector

2.2 Mounting

Mount the unit on a bench, table top or shelf in a horizontal position and operate at least ten inches from any air obstructions to the fan, front panel, rear panel, bottom and top of the unit, in an ambient environment between the specified 5 to 45°C (41 to 113°F).

2.3 Ambient Temperature

The target plate of the BB702 can achieve any temperature within the specified temperature range when being operated in ambient temperature up to 32.2°C (90°F). When operating the unit at higher ambient temperatures, the user must not exceed the "Maximum Allowable Target Plate Temperature" shown along the y-axis in Figure 2. Failure to adhere to these guidelines may cause a safety switch inside the unit to open the heater circuit. If the PID light is blinking or continuously on but there is no increase in target plate temperature, then the thermal safety switch has tripped. In this case refer to Section 3-6. When ambient temperatures exceeds 32.2°C (90°F), every increase in ambient temperature of 2.8°C (5°F) must be accompanied by a decrease in maximum target plate temperature of 11.1°C (20°F).

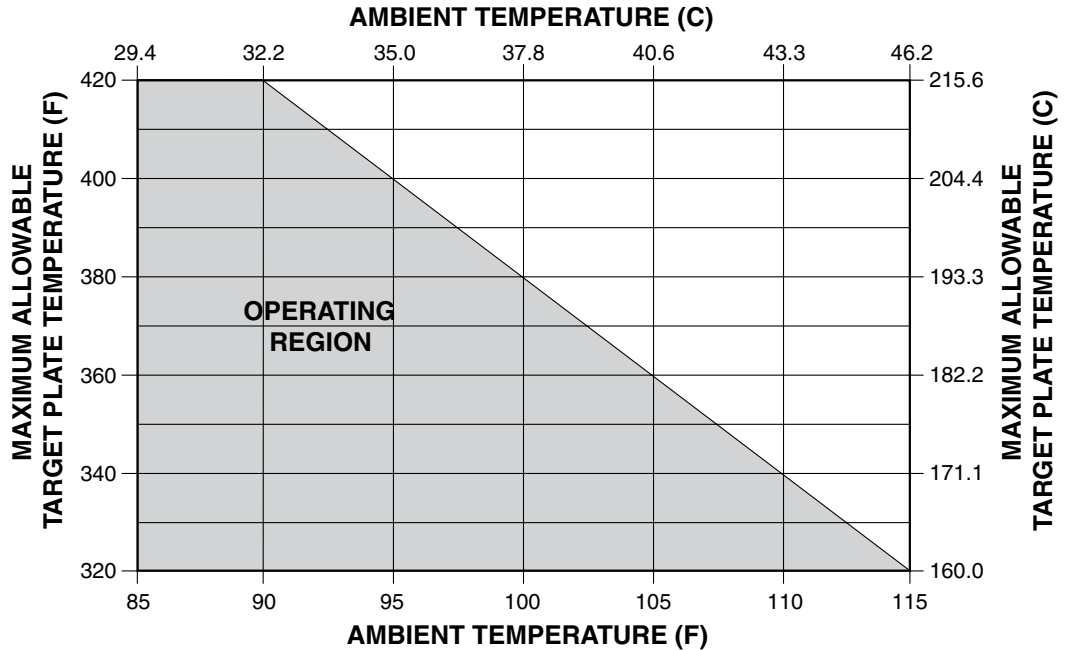

Figure 2. Limitation of Maximum Setpoint Temperature at Elevated Ambient Temperature.

2.4 Power Connection

Standard (115 VAC~, 50/60 Hz models)

The BB702 comes with a standard North American 3-prong AC power cord. Do not use any other power cord other than the one provided. This cord provides the proper grounding and has been safety tested by the proper safety agencies.

International (230 VAC~, 50/60 Hz models)

On 230 VAC~, 50/60Hz models a European style power cord with the proper color code and approvals is provided with stripped wire ends for connection to the proper connector used in your country or local area, this connector is not provided.

CAUTION:

- Line voltage variations are not to exceed $\pm 10\%$ of the rated input voltage.
- Electrical connections and wiring should be performed only by suitably trained personal.
- To shut down the unit in an emergency, the power cord can be disconnected from the AC outlet on the rear of the unit.

Section 3 - Operation

3.1 Front Panel Controls and Indicators

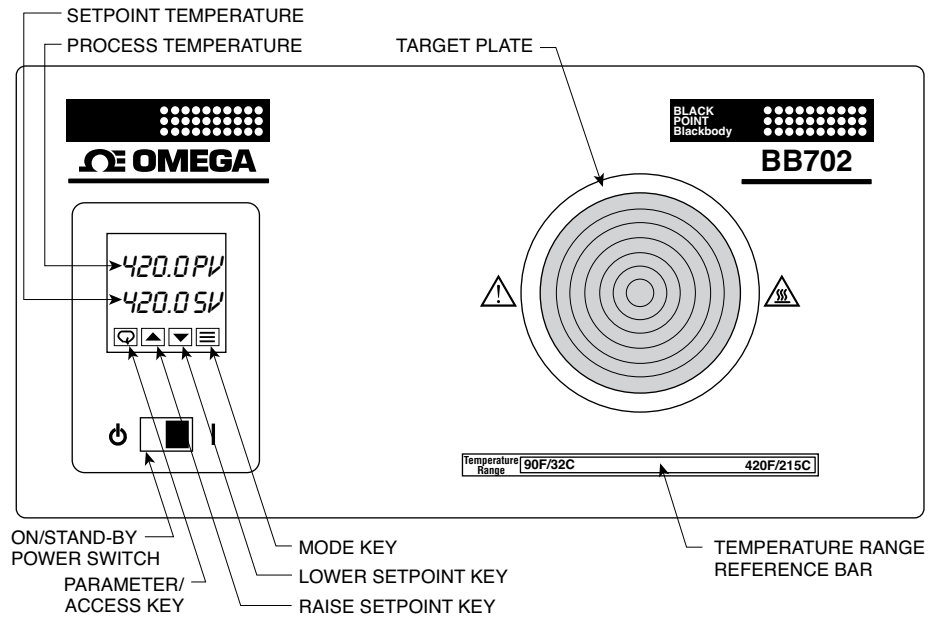

Figure 3. Front Panel

Process Temperature:

This field displays the current temperature of the target plate.

Setpoint Temperature:

This field displays the desired target plate temperature. Once the target plate reaches this desired temperature, both displays will read the same value.

Target Plate:

The 4.0" target plate is a near ideal blackbody source. The emissivity of the plate is .95. When calibrating an IR pyrometer, hold the pyrometer perpendicular to the target plate for optimal performance. The proper distance between the IR pyrometer and the target plate depends on the field of view of the pyrometer. If the pyrometer is too far away it will scan unwanted surfaces outside of the perimeter of the target plate. Holding the pyrometer too close could introduce undesirable heat to the IR detector of the pyrometer.

CAUTION:

The BB702's target plate can be set to very high temperatures. Exercise extreme caution when operating the unit. Keep hands and fingers away from the target plate area. Keep flammable products such as paper, plastics and clothing far from the BB702.

NOTE:

P.I.D. Control:

Proportional, integral, derivative control (P.I.D.) is a temperature control algorithm used in high-end temperature controllers. The controller causes the process to attain the desired temperature by turning the process on or off. The process may be a heater or refrigerator. As the process temperature approaches the setpoint temperature the hot or cold process will be pulsed to reduce the corrective measures and minimize overshooting. The controller provides a visual representation of the process status through LED indicators. An indicator may be lit continuously, blink or shut off entirely to indicate that the process is on, being pulsed, or off, respectively.

**Parameter/Access Key:**

Press to scroll through menu parameters

**Raise Key:**

Press to increase the selected parameter or scroll upward in the list of possible settings.

**Lower Key:**

Press to decrease the selected parameter or scroll downward in the list of possible settings.

**Mode Key:**

Press to save settings and exit a menu level.

3.2 Back Panel Connections

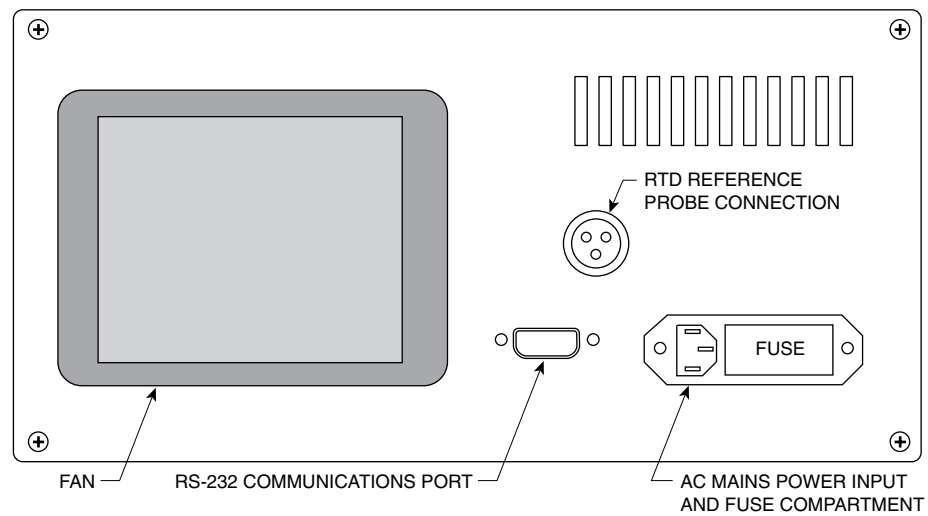

Figure 4. Back Panel

AC Power Mains Input and Fuse Compartment:

The customer connects the power cord to the AC Power Input. As a safety precaution, the power cord cannot be connected if the fuse compartment is open. Refer to Section 5.3 for information on fuse replacement.

Reference Probe Connection:

The reference probe enables the user to monitor the target plate temperature with an external instrument. The wires are connected to a Class A, 0.00385 RTD Sensor. Refer to Section 6 for pinout details.

RS232 Communications Port:

The female DB-9 port allows the customer to make a 3-wire RS232 interface with the BB-702. A detailed description of this port is described in Section 4.

3.3 Changing the Temperature Setpoint

The layout of the front panel is shown in Figure 3. The BB702 incorporates a PID digital setpoint controller. The upper display indicates the blackbody target plate temperature known as (PV) Process Variable, while the lower display indicates the programmed setpoint known as (SV) Setpoint Variable. Making changes to the setpoint, units of measure and communication settings are made via the “▲” and “▼” keys. Holding a key in, continuously, will cause the setpoint temperature to advance more quickly to a desired value. Three scanning speeds are provided: slow, medium and fast. The minimum and maximum setpoints are locked.

3.4 Changing the Controller Parameter Settings

The BB702 operates at its optimum performance when left with its factory parameter settings. The only internal parameter that the operator should need to change is the engineering units (°F or °C), or serial communications parameters. Below are two figures: a) menu hierarchy with factory default settings; b) programming procedure.

CAUTION:

Changing any parameter other than engineering units could defeat safety features of the unit rendering it unsafe to operate.







Menu 00	Menu 01	Menu 02	Menu 03	Menu 04	Menu 05
Key Lock	SETPOINT	Ac.Cd = 02	Ac.Cd = 03	Ac.Cd = 04	Ac.Cd = 05
	Ac.Cd				
		Gn.o1 434	ALr1 440	id.no 01	SnSr P
		Gr.o2	ALr2	BAUd 12.o.7	Sn.00
		rAtE 4	Cy.t1 0	CAL.L	dEC.P
		rSEt 21	Cy.t2	CAL.H	FILt
		H.Hys	SP.tt OFF		OUt.1 Ht.P
		HyS.1	L.SP.L 90		OUt.2 Alr
		C.HyS	L.SCL		CoL.t nor
		HyS.2	U.SP.L 420		A1.HL HI
		C.SPr	H.SCL		A1.Pd Pr
		SPr.2			A1.OP LAt
		dPnG nl			A2.HL HI
					A2.Pd Pr
					A2.OP OFF
					Unit F

Figure 5. Menu Hierarchy Showing Factory Default Settings

NOTE:

Only the boldface parameters are active for the default mode of operation.

Changing the Controller's Parameter Settings

1. Press the  key to enter the programming mode. The lower display will alternately display the menu level and "Ac.Cd."
2. Use the  and  keys to change to the desired menu level.
3. Once you have chosen the desired menu use the  key to scroll through the parameters. To change the setting of a given parameter, use the  and  keys.
4. To save settings press the  key. The controller now exits the programming menu and return to the normal operating mode.
5. To change settings on other menu levels, you must re-enter the programming menu (from step #1).

Putting the Controller In or Out of Standby Mode



1. To enter the Standby mode hold the  key for 4 seconds until the window flashes "StbY".
2. To exit the Standby mode hold the  key for 4 seconds until the window flashes "tUne". Then press the  key for 4 seconds again until "tUne" stops flashing.

Figure 6. Programming Procedure

3.5 Heat-Up/Cool-Down Cycle Times

Approximate cycle times for heat up and cool down are given in Fig. 7. To find a transition time from one plate temperature to another follow this procedure: Look for an initial temperature in the left column. Next, look for the final temperature along the top row. The intersection of the row and column provides the approximate transition time.

		TO:		
		37.8C	121.1C	204.4C
FROM:		100F	250F	400F
37.8C	100F	 	4.5 MIN.	20 MIN.
121.1C	250F.	35 MIN.	 	7.5 MIN.
204.4C	400F	45 MIN.	9.5 MIN.	

Figure 7. Heat Up/ Cool Down Cycle Time Table.

3.6 Overheat Reset Switch

If the unit is operated at high temperatures in elevated ambient temperatures, an overheat condition may occur. In an overheat situation a mechanical reset switch near the right handle hinge will pop and open the heater circuit. The controller will still have power. While the controller will be demanding heat from the heater, the process temperature will fall continuously until it equalizes with the room temperature. If an overheat condition occurs, let the unit cool off for one hour (leave the unit on), then press the reset button, firmly. If the reset switch keeps resetting, call OMEGA's Customer Service Department.

Section 4 - RS232 Communication

The RS232 port allows customers to send Setpoint information to the BB702 and record process temperature from the BB702 via a computer. The port enables bi-directional data transfer via a three-conductor cable consisting of signal ground, receive input, and transmit output. It is recommended that less than fifty feet of shielded cable be used between the computer and this instrument. This will assure performance of the BB702 to EN61326, under the E.M.C. Note that multiple instruments cannot be tied to the same port in this configuration. The RS232 port is optically isolated to eliminate ground loop problems.

Below is a pinout diagram for the serial port of the BB702 as well as the pinout for a 9-pin PC serial port. Use a straight DB9 (female) to DB9 (male) connector cable to connect your computer to the BB702. The cable should be attached when the computer and BB702 are off.

Only parameters in the parameter list should be modified or queried via the serial port. Other parameters should be viewed or queried from the controller, directly. It is highly recommended that baud rate for the controller be modified on the controller, directly. Note that both the BB702 and the computer must be communicating with the same serial communications parameters to establish a working communication link.

The serial communications feature can be tested using terminal emulation package. Note that this controller does not time out waiting for the next character to be transmitted. Be sure not to use the XON/XOFF or hardware handshaking. Lastly, it should be noted that following a complete transmission to the BB702, a response it sent back. If the message was valid, the changed or queried parameter is echoed back (following the same format). If the message was not according to acceptable format or was attempting to force a parameter out of range, an "ERROR" message is echoed.

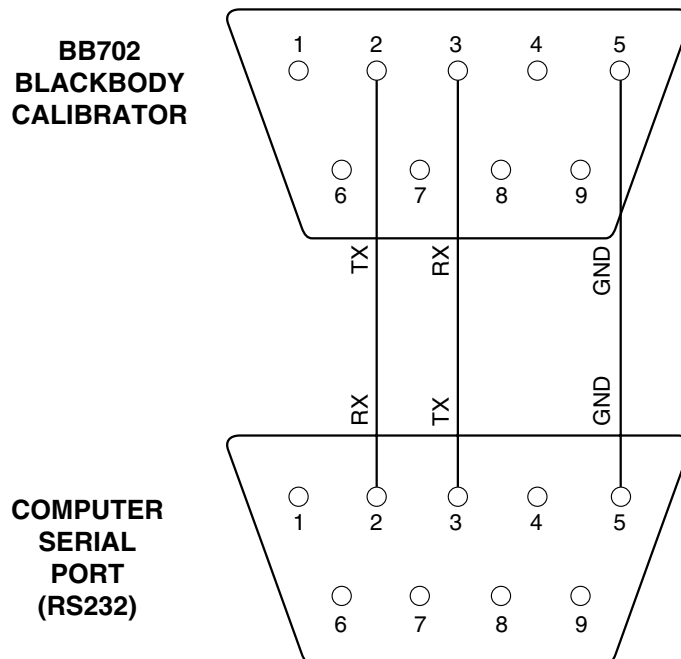

Figure 8. Connecting the BB702 to a Computer's Serial Port

Parameter List (only relevant parameters shown):

<u>PAR#:</u>	<u>Parameter:</u>	<u>Range/Units:</u>
00	Process Temp.	Input determined
01	Setpoint	Input determined
19	Baud Selection	bAUd

Baud Selections:

<u>Code:</u>	<u>Baud:</u>	<u>Parity:</u>	<u>Data Bits:</u>	<u>Stop Bits:</u>
3.o.7	300	odd	7	2
6.o.7	600	odd	7	2
12.o.7	1200	odd	7	2 (factory default settings)
24.o.7	1200	odd	7	2
3.n.8	300	no	8	1
6.n.8	600	no	8	1
12.n.8	1200	no	8	1
24.n.8	2400	no	8	1

General Message Format:

#[controller id][command][parameter number]<new value><units>[CR/LF]

Definitions:

- This character initiates an "escape sequence" that the controller will recognize.

[controller id] – Up to 2 numeric characters, "00" to "99" (factory default="01")

[command] – 1 character, upper case or lower case

“R” – To read a parameter from the controller

“M” – To temporarily modify a controller parameter (lost upon shutdown)

“E” – To modify a controller param. in non-volatile mem. (saved even after shutdown)

[parameter #] – Up to 2 numeric characters, "00" to "99"

<new value> - This control word is used only when entering or modifying a parameter. Up to 6 characters may be entered. The first character can be a space, a "+", or a "-". The next 4 characters are for entering the new value parameter value. Be sure to use the exact same field format as is currently being used. (i.e. if the XXX.X format is used to express temperature, be sure to enter a new value that conforms to the same format).

<units> - This optional control word is used to specify units, F for °F, C for °C.

[CR/LF] – Every transmission must be terminated with a carriage return [CR] character. The line feed [LF] character is optional.

Section 5 - Maintenance

5.1 Calibration

This unit has been fine tuned at the factory and calibrated to give optimum performance of its full temperature range. It is recommended that the unit be returned annually for re-calibration.

5.2 Cleaning

CAUTION:

Remove all electrical connections and power before attempting any maintenance or cleaning.

5.2.1 Main Body

Only a damp, soft rag with a mild cleaning solution should be used when cleaning the main body of this unit.

5.2.2 Target Plate

Do not attempt to clean the target plate. The target plate has a special coating applied and cleaning may change the emissivity and performance of your unit.

5.2.3 Fan

The fan filter should be cleaned monthly as a minimum by washing the filter with warm water and then blowing dry with air. It can be removed by firmly pulling the black plastic frame outward. The internal protective grill that is seated against the fan can be cleaned with a soft bristle brush.

5.3 Fuse replacement

WARNING:

Disconnect all power from source before attempting fuse replacement.

CAUTION:

For continued protection against the risk of fire replace with only the same size, type and rating fuse indicated here and on the rear panel of your unit.

For model: **BB702** use 1 ea. 250 VAC~, T1A (Time-Lag, 1 Amp)
UL./CSA APPROVED (0.25" dia. x 1.25" long).

For model: **BB702-230VAC** use 2 ea. 250 VAC~, T0.5A (Time-Lag, 0.5 Amp)
VDE APPROVED (5 mm dia. x 20 mm long).

Section 6 - Reference Probe

An electrically isolated 100 Ω Class A RTD probe has been embedded into the target plate heater assembly to be used as a reference. This feature is commonly used in conjunction with a precision thermometer, ohmmeter or temperature recording device. The maximum current being passed through the RTD should never exceed 0.3 mA (constant DC). A connector has been provided with your calibrator for connection to this reference probe. Notice that at each temperature, a given resistance will be measured at the reference port. The resistance is measured across PIN1-PIN2 or across PIN1-PIN3. PIN2 and PIN3 are connected to the same side of the RTD.

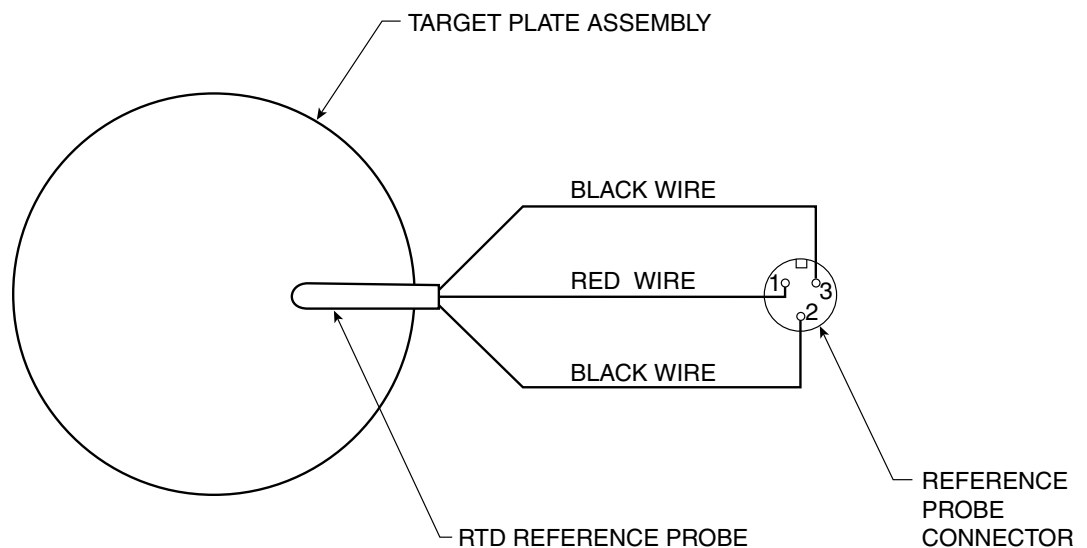

Figure 9. Internal Reference Probe Connections

Section 7 - Specifications

Target Plate Temperature Range:	Amb. + 11 to 215°C (Amb. + 20 to 420°F)
Accuracy:	±0.5°C, ±0.25% rdg (±0.9°F, ±0.25% rdg)
Stability:	±0.1°C (±0.2 °F)
Ambient Environmental Conditions	
Temperature:	5 to 45 °C (41 to 113°F)
Humidity:	0 to 90% RH, Non-condensing
Target Plate Size:	63.5 mm (2.5")
Target Plate Emissivity:	0.95*
Internal Control Sensor:	Platinum RTD, Class A, Alpha = 0.00385
Reference Sensor:	Platinum RTD, Class A, Alpha = 0.00385
Warm-up Time:	See Figure 7, Section 3.5
Cool-down Time:	See Figure 7, Section 3.5
Power	
BB702:	115 VAC~, 50/60 Hz, 75W.
BB702-230VAC:	230 VAC~, 50/60 Hz, 75W
Dimensions:	152 x 305 x 280 mm (6 H x 12 W x 11"L)
Weight:	7.2 kg (16 lb)
Installation Category II	

* Reference to 8-14 microns wavelength bandwidth.

Section 8 - Troubleshooting Guide

Problem	Solution
1. Unit will not turn on.	<ol style="list-style-type: none">Check Power Cord connections.Check rear panel fuse(s).Unit requires service, contact our customer service department.
2. Unit turns on but the target plate will not get hot.	<ol style="list-style-type: none">Check that you have entered a setpoint between Ambient +20 to 420°F.Verify that the controller is set to its factory default settings.Unit has overheated causing the thermal reset switch to open. See Section 3.6.Unit requires service, contact our customer service department.
3. Controller display shows "Error" and the target will not get hot.	<ol style="list-style-type: none">Unit requires service, contact our customer service department.
4. Cavity cone temperature will not stabilize to within $\pm 2^{\circ}\text{F}$ of the setpoint temperature.	<ol style="list-style-type: none">Verify that the controller is set to its factory default settings.Unit requires service, contact our customer service department.
5. Unable to communicate with the unit through the RS232 connection port.	<ol style="list-style-type: none">Check that you have made the proper wiring connections between your unit and computer.Check for proper communication parameter settings in the controller and your computer, Baud, parity, etc...Check that your message string contains the correct letters and characters for the command you want to send.Unit requires service, contact our customer service department.

Section 9 - Glossary of Terms Used in This Manual

Blackbody

A theoretical object that radiates the maximum amount of energy at a given temperature, and absorbs all the energy incident upon it.

Calibration

The process of adjusting an instrument or compiling a deviation chart so that its reading can be correlated to the actual value being measured.

Emissivity

The ratio of energy emitted by a surface to the energy emitted by a blackbody at the same temperature.

IEC

International Electrotechnical Commission

Infrared (IR)

A range of the electromagnetic spectrum extending beyond red visible light from 760 nanometers to 1000 microns.

PID

Proportional, Integral, Derivative. A three mode control action where the controller has time proportioning, integral (auto reset) and derivative rate action.

RTD

Resistance temperature detector

The OMEGA Family of Blackbody Calibrators

Listed below is a selection guide of OMEGA's current line of blackbody calibration sources in addition to the one you have selected. This family of rugged, portable and accurate calibrators cover a wide range of temperatures, target plate sizes and features making them perfect for infrared pyrometer field service testing and laboratory calibrations.

BB701 Hot/Cold Blackbody Calibration Source

Calibration Range: -18 to 149°C (0 to 300°F)

Emissivity: 0.95

Cavity Size: 63.5 mm (2.5 in.)

Accuracy: ±0.8°C (±1.4 °F)

Ambient Temp.: 4 to 43°C (40 to 110°F)

Power: 115/230V, 50/60 Hz, 175W

BB702 Blackbody Calibration Source

Calibration Range: 32 to 215°C (amb. 90 to 420°F)

Emissivity: 0.95

Cavity Size: 63.5 mm (2.5 in.)

Accuracy: ± 0.5°C (±0.9°F), ±0.25% rdg.

Ambient Temp.: 5 to 45°C (41 to 113°F)

Power: 115/230V, 50/60 Hz, 75W

BB703 Mini Blackbody Calibration Source

Calibration Range: 32 to 400°C (90 to 752°F)

Emissivity: 0.95

Cavity Size: 28.6 mm (1.125 in.)

Accuracy: ±1.4°C (±2.5°F)

Ambient Temp.: 0 to 40°C (32 to 104°F)

Power: 115/230V, 50/60 Hz, 175W

BB704 4" Target Plate Blackbody Calibration Source

Calibration Range: 100 to 400°C (212 to 752°F)

Emissivity: 0.95

Cavity Size: 101.6 mm (4 in.)

Accuracy: ±0.8°C (±1.4°F)

Ambient Temp.: 0 to 50°C (32 to 122°F)

Power: 115/230V, 50/60 Hz, 425W

BB705 Laboratory Grade Blackbody Calibration Source

Calibration Range: 100 to 1046°C (212 to 1915°F)

Emissivity: 0.99

Cavity Size: 44 mm (1.75 in.)

Accuracy: ±1.0°C (±1.8°F), ±0.25% rdg

Ambient Temp.: 0 to 35°C (32 to 95°F)

Power: 115/230V, 50/60 Hz, 1100W

BB-4A High Temperature Blackbody Calibration Source

Calibration Range: 100 to 982°C (212 to 1800°F)

Emissivity: 0.99

Cavity Size: 22.2 mm (0.88 in.)

Accuracy: ±1.0°C (±1.8°F), ±0.25% rdg

Ambient Temp.: 0 to 50°C (32 to 122°F)

Power: 115/230V, 50/60 Hz, 400W

For a complete, updated specification sheet and price on any of the calibrators listed here visit our website at www.omega.com. Please call our sales or customer service department for information and pricing on any new models available.

NOTES:

WARRANTY/DISCLAIMER

OMEGA ENGINEERING, INC. warrants this unit to be free of defects in materials and workmanship for a period of **25 months** from date of purchase. OMEGA's WARRANTY adds an additional one (1) month grace period to the normal **one (2) year product warranty** to cover handling and shipping time. This ensures that OMEGA's customers receive maximum coverage on each product.

If the unit malfunctions, it must be returned to the factory for evaluation. OMEGA's Customer Service Department will issue an Authorized Return (AR) number immediately upon phone or written request. Upon examination by OMEGA, if the unit is found to be defective, it will be repaired or replaced at no charge. OMEGA's WARRANTY does not apply to defects resulting from any action of the purchaser, including but not limited to mishandling, improper interfacing, operation outside of design limits, improper repair, or unauthorized modification. This WARRANTY is VOID if the unit shows evidence of having been tampered with or shows evidence of having been damaged as a result of excessive corrosion; or current, heat, moisture or vibration; improper specification; misapplication; misuse or other operating conditions outside of OMEGA's control. Components in which wear is not warranted, include but are not limited to contact points, fuses, and triacs.

OMEGA is pleased to offer suggestions on the use of its various products. However, OMEGA neither assumes responsibility for any omissions or errors nor assumes liability for any damages that result from the use of its products in accordance with information provided by OMEGA, either verbal or written. OMEGA warrants only that the parts manufactured by the company will be as specified and free of defects. OMEGA MAKES NO OTHER WARRANTIES OR REPRESENTATIONS OF ANY KIND WHATSOEVER, EXPRESSED OR IMPLIED, EXCEPT THAT OF TITLE, AND ALL IMPLIED WARRANTIES INCLUDING ANY WARRANTY OF MERCHANTABILITY AND FITNESS FOR A PARTICULAR PURPOSE ARE HEREBY DISCLAIMED. LIMITATION OF LIABILITY: The remedies of purchaser set forth herein are exclusive, and the total liability of OMEGA with respect to this order, whether based on contract, warranty, negligence, indemnification, strict liability or otherwise, shall not exceed the purchase price of the component upon which liability is based. In no event shall OMEGA be liable for consequential, incidental or special damages.

CONDITIONS: Equipment sold by OMEGA is not intended to be used, nor shall it be used: (1) as a "Basic Component" under 10 CFR 21 (NRC), used in or with any nuclear installation or activity; or (2) in medical applications or used on humans. Should any Product(s) be used in or with any nuclear installation or activity, medical application, used on humans, or misused in any way, OMEGA assumes no responsibility as set forth in our basic WARRANTY/DISCLAIMER language, and, additionally, purchaser will indemnify OMEGA and hold OMEGA harmless from any liability or damage whatsoever arising out of the use of the Product(s) in such a manner.

RETURN REQUESTS/INQUIRIES

Direct all warranty and repair requests/inquiries to the OMEGA Customer Service Department. BEFORE RETURNING ANY PRODUCT(S) TO OMEGA, PURCHASER MUST OBTAIN AN AUTHORIZED RETURN (AR) NUMBER FROM OMEGA'S CUSTOMER SERVICE DEPARTMENT (IN ORDER TO AVOID PROCESSING DELAYS). The assigned AR number should then be marked on the outside of the return package and on any correspondence.

The purchaser is responsible for shipping charges, freight, insurance and proper packaging to prevent breakage in transit.

FOR **WARRANTY** RETURNS, please have the following information available BEFORE contacting OMEGA:

1. Purchase Order number under which the product was PURCHASED,
2. Model and serial number of the product under warranty, and
3. Repair instructions and/or specific problems relative to the product.

FOR **NON-WARRANTY** REPAIRS, consult OMEGA for current repair charges. Have the following information available BEFORE contacting OMEGA:

1. Purchase Order number to cover the COST of the repair,
2. Model and serial number of the product, and
3. Repair instructions and/or specific problems relative to the product.

OMEGA's policy is to make running changes, not model changes, whenever an improvement is possible. This affords our customers the latest in technology and engineering.

OMEGA is a trademark of OMEGA ENGINEERING, INC.

© Copyright 2017 OMEGA ENGINEERING, INC. All rights reserved. This document may not be copied, photocopied, reproduced, translated, or reduced to any electronic medium or machine-readable form, in whole or in part, without the prior written consent of OMEGA ENGINEERING, INC.

Where Do I Find Everything I Need for Process Measurement and Control? **OMEGA...Of Course!** *Shop online at omega.com*

TEMPERATURE

- ☑ Thermocouple, RTD & Thermistor Probes, Connectors, Panels & Assemblies
- ☑ Wire: Thermocouple, RTD & Thermistor
- ☑ Calibrators & Ice Point References
- ☑ Recorders, Controllers & Process Monitors
- ☑ Infrared Pyrometers

PRESSURE, STRAIN AND FORCE

- ☑ Transducers & Strain Gages
- ☑ Load Cells & Pressure Gages
- ☑ Displacement Transducers
- ☑ Instrumentation & Accessories

FLOW/LEVEL

- ☑ Rotameters, Gas Mass Flowmeters & Flow Computers
- ☑ Air Velocity Indicators
- ☑ Turbine/Paddlewheel Systems
- ☑ Totalizers & Batch Controllers

pH/CONDUCTIVITY

- ☑ pH Electrodes, Testers & Accessories
- ☑ Benchtop/Laboratory Meters
- ☑ Controllers, Calibrators, Simulators & Pumps
- ☑ Industrial pH & Conductivity Equipment

DATA ACQUISITION

- ☑ Communications-Based Acquisition Systems
- ☑ Data Logging Systems
- ☑ Wireless Sensors, Transmitters, & Receivers
- ☑ Signal Conditioners
- ☑ Data Acquisition Software

HEATERS

- ☑ Heating Cable
- ☑ Cartridge & Strip Heaters
- ☑ Immersion & Band Heaters
- ☑ Flexible Heaters
- ☑ Laboratory Heaters

ENVIRONMENTAL MONITORING AND CONTROL

- ☑ Metering & Control Instrumentation
- ☑ Refractometers
- ☑ Pumps & Tubing
- ☑ Air, Soil & Water Monitors
- ☑ Industrial Water & Wastewater Treatment
- ☑ pH, Conductivity & Dissolved Oxygen Instruments