

CE

# User's Guide

 **iSeries**



Shop on line at

**omega.com**<sup>®</sup>

OMEGA<sup>®</sup>

[www.omega.com](http://www.omega.com)

e-mail: [info@omega.com](mailto:info@omega.com)

iSeries info:

[www.omega.com/specs/iseries](http://www.omega.com/specs/iseries)

[omegamannual.info](http://omegamannual.info)

**Temperature/Process Limit Controller  
CNI8-AL/CNI16-AL/CNI32-AL**



OMEGAnet® Online Service  
omega.com

Internet e-mail  
info@omega.com

### Servicing North America:

**U.S.A.:** Omega Engineering, Inc., One Omega Drive, P.O. Box 4047  
Stamford, CT 06907-0047 USA  
ISO 9001 Certified  
Toll Free: 1-800-826-6342  
FAX: (203) 359-7700  
TEL: (203) 359-1660  
e-mail: info@omega.com

**Canada:**  
976 Berar  
Laval (Quebec), H7L 5A1, Canada  
Toll-Free: 1-800-826-6342  
FAX: (514) 856-6886  
TEL: (514) 856-6928  
e-mail: info@omega.ca

### For immediate technical or application assistance:

**U.S.A. and Canada:** Sales Service: 1-800-826-6342 / 1-800-TC-OMEGA®  
Customer Service: 1-800-622-2378 / 1-800-622-BEST®  
Engineering Service: 1-800-872-9436 / 1-800-USA-WHEN®

**Mexico/  
Latin America:** TEL: 001 (203) 359-1660  
FAX: 001 (203) 359-7700  
e-mail: espanol@omega.com

### Servicing Asia:

**China:** 1698 Yi Shan Road, Unit 102  
Min Hang District  
Shanghai, China 201103 P.R.C.  
Hotline: 800 819 0559 / 400 619 0559  
e-mail: info@cn.omega.com

### Servicing Europe:

**Benelux:** Toll-Free: 0800 099 3344  
FAX: +31 20 643 46 43  
TEL: +31 20 347 21 21  
e-mail: sales@omegaeng.nl

**Czech Republic:** Frystatska 184  
733 01 Karviná, Czech Republic  
TEL: +420-59-6311899  
FAX: +420-59-6311114  
e-mail: info@omegashop.cz

**France:** Toll-Free: 0805 541 038  
FAX: 01 57 32 48 18  
TEL: 01 57 32 48 17  
e-mail: esales@omega.fr

**Germany/ Austria:** Daimlerstrasse 26  
D-75392 Deckenpfronn, Germany  
Toll-Free: 0800 8266342  
FAX: +49 (0) 7056 9398-29  
TEL: +49 (0) 7056 9398-0  
e-mail: info@omega.de

**United Kingdom:** OMEGA Engineering Ltd.  
ISO 9001 Certified  
One Omega Drive, River Bend Technology Centre, Northbank  
Irlam, Manchester M44 5BD United Kingdom  
Toll-Free: 0800-488-488  
FAX: +44 (0) 161 777-6622  
TEL: +44 (0) 161 777-6611  
e-mail: sales@omega.co.uk

It is the policy of OMEGA Engineering, Inc. to comply with all worldwide safety and EMC/EMI regulations that apply. OMEGA is constantly pursuing certification of its products to the European New Approach Directives. OMEGA will add the CE mark to every appropriate device upon certification.

The information contained in this document is believed to be correct, but OMEGA accepts no liability for any errors it contains, and reserves the right to alter specifications without notice.

**WARNING:** These products are not designed for use in, and should not be used for, human applications.

# TABLE OF CONTENTS

<b>Part 1: Introduction</b> .....	1
1.1 Description .....	2
1.2 Safety Considerations .....	3
1.3 Before You Begin .....	4
<b>Part 2: Setup</b> .....	5
2.1 Front Panel .....	5
2.2 Disassembly .....	6
2.3 Electrical Installation .....	7
2.3.1 Power Connections .....	7
2.3.3 Thermocouple - Input Connection .....	8
2.3.4 Two / Three / Four Wire RTD-Hookups .....	9
2.3.5 Process Current - Wiring Hookup .....	10
2.3.6 Process Voltage - Wiring Hookup .....	10
2.3.7 Wiring Outputs - Wiring Hookup .....	11
<b>Part 3: Operation: Configuration Mode</b> .....	12
3.1 Introduction .....	12
Turning your device On for the First Time	
Buttons Functions in Configuration Mode	
3.2 Menu Configuration .....	13
3.2.1 ID Number .....	14
3.2.2 Setpoints .....	15
3.2.3 Configuration Menu .....	16
3.2.4 Input Type Menu .....	17
3.2.4.1 Input Type (Thermocouple) .....	18
3.2.4.2 Input Type (RTD) .....	19
3.2.4.3 Input Type (Process) .....	20
3.2.5 Reading Configuration Menu .....	21
3.2.6 Alarm 1 Menu .....	25
3.2.7 Alarm 2 Menu .....	29
3.2.8 Reading Adjust Menu .....	30
3.2.9 Setpoint Deviation Menu/Field Calibration .....	31
3.2.10 ID Code Menu .....	32
3.2.11 Display Color Selection Menu .....	41
<b>Part 4: Specifications</b> .....	44
<b>Part 5: Factory Preset Values</b> .....	47
<b>CE APPROVAL INFORMATION</b> .....	48

## LIST OF FIGURES:

Figure 2.1	Front Panel Display.....	5
Figure 2.2	Rear Panel Input Connector Labels .....	6
Figure 2.4	Main Power Connections .....	7
Figure 2.5	Thermocouple Wiring Hookup .....	8
Figure 2.6	Two/Three/Four-Wire RTD Wiring Hookup	
	a) RTD-1000 ohm/RTD-500 ohm.....	9
	b) RTD-100 ohm .....	9
Figure 2.7	Process Current Wiring Hookup (Internal and External Excitation) .....	10
Figure 2.8	Process Voltage Wiring Hookup	
	a) With Sensor Excitation .....	10
	b) Without Sensor Excitation.....	10
Figure 2.9	Mechanical Relay Outputs Wiring Hookup .....	11
Figure 2.10	Excitation Output .....	11
Figure 3.1	Flow Chart for ID and Setpoints .....	13
Figure 3.2	Flow Chart for Configuration Menu .....	16
Figure 3.3	Flow Chart for Input Type Menu .....	17
Figure 3.4	Flow Chart for Reading Configuration .....	21
Figure 3.5	Flow Chart for Alarm 1 .....	25
Figure 3.6	Flow Chart for Alarm 2 .....	29
Figure 3.7	Flow Chart for Reading Adjust .....	30
Figure 3.8	Flow Chart for Setpoint Deviation/Field Calibration .....	31
Figure 3.9	Flow Chart for ID Code .....	32
Figure 3.10	Flow Chart for Display Color Selection .....	41

## LIST OF TABLES:

Table 2.1	Front Panel Annunciators .....	5
Table 2.2	Rear Panel Connector .....	6
Table 2.3	Power Connections .....	7
Table 2.4	TC Wire Color Chart .....	8
Table 3.1	Button Function in Configuration Mode.....	12
Table 3.2	Conversion Table.....	24
Table 4.1	Input Properties .....	46
Table 5.1	Factory Preset Values .....	47

## NOTES, WARNINGS and CAUTIONS

Information that is especially important to note is identified by the following labels:

- **NOTE**
- **WARNING or CAUTION**
- **IMPORTANT**
- **TIP**



**NOTE:** Provide you with information that is important to successfully setup and use the Programmable Digital System.



**CAUTION or WARNING:** Tells you about the risk of electrical shock.



**CAUTION, WARNING or IMPORTANT:** Tells you of circumstances or practices that can affect the instrument's functionality and must refer to accompanying documents.



**TIP:** Provides you helpful hints.

## PART 1 INTRODUCTION

### 1.1 Description

The iSeries Limit Alarm Controller offers unparalleled flexibility in process measurement and alarm applications, accepting 10 different thermocouple types, 18 RTD combinations or 4 process voltage/current inputs and providing 2 relay alarm outputs and a large multi-color, programmable display. Easily configured options include 11 different alarm conditions and the unit supports an external reset input and a buzzer audio annunciator.

Front panel configuration switches allow the user to select the type of input, the alarm conditions and the resulting display color. Process inputs are fully scalable, supporting virtually all engineering units with a selectable decimal point providing a perfect solution for pressure, flow or other process inputs.

Standard features include a built-in 24 Vdc excitation source for transmitters or other devices and a universal power supply that accepts 90 to 240 Vac. A low power option is available that supports 24 Vac or 12 to 36 Vdc.

## 1.2 Safety Considerations

---



This device is marked with the international caution symbol. It is important to read this manual before installing or commissioning this device as it contains important information relating to Safety and EMC (Electromagnetic Compatibility).

---

This device is a panel mount device protected in accordance with EN 61010-1:2001, electrical safety requirements for electrical equipment for measurement, control and laboratory. Installation of this device should be done by qualified personnel. In order to ensure safe operation, the following instructions should be followed.



This device has no power-on switch. An external switch or circuit-breaker shall be included in the building installation as a disconnecting device. It shall be marked to indicate this function, and it shall be in close proximity to the equipment within easy reach of the operator. The switch or circuit-breaker shall meet the relevant requirements of IEC 947-1 and IEC 947-3 (International Electrotechnical Commission). The switch shall not be incorporated in the main supply cord.



Furthermore, to provide protection against excessive energy being drawn from the main supply in case of a fault in the equipment, an overcurrent protection device shall be installed.



- Do not exceed voltage rating on the label located on the top of the device housing.
- Always disconnect power before changing signal and power connections.
- Do not use this device on a work bench without its case for safety reasons.
- Do not operate this device in flammable or explosive atmospheres.
- Unit mounting should allow for adequate ventilation to ensure device does not exceed operating temperature rating.
- Use electrical wires with adequate size to handle mechanical strain and power requirements. Install without exposing bare wire outside the connector to minimize electrical shock hazards.

### EMC Considerations

- Whenever EMC is an issue, always use shielded cables.
- Never run signal and power wires in the same conduit.
- Use signal wire connections with twisted-pair cables.
- Install Ferrite Bead(s) on signal wires close to the device if EMC problems persist.

**Failure to follow all instructions and warnings may result in injury!**

## 1.3 Before you Begin

### Inspecting Your Shipment:

Remove the packing slip and verify that you have received everything listed. Inspect the container and equipment for signs of damage as soon as you receive the shipment. Note any evidence of rough handling in transit. Immediately report any damage to the shipping agent. The carrier will not honor damage claims unless all shipping material is saved for inspection. After examining and removing the contents, save the packing material and carton in the event reshipment is necessary.

### Customer Service:

If you need assistance, please call the nearest Customer Service Department, listed in this manual.

### Manuals:

The latest Operation Manual is available from the **website listed in this manual**.

### To Reset the Meter:

When the device is in the "MENU" Mode, **push  once** to direct device one step backward of the top menu item.

**Push  twice** to reset device, prior to resuming "Run" Mode except after "Alarms", that will go to the "Run" Mode without resetting the device.

When using external reset switch: when the device is in the "RUN" Mode, **push  twice** to disable all outputs and alarms. It is now in "STANDBY" Mode.

**Push  once** more to resume "RUN" Mode.

 **Tip #10**

**Push  twice** to disable the system during an **EMERGENCY**.

## PART 2 SETUP

### 2.1 Front Panel

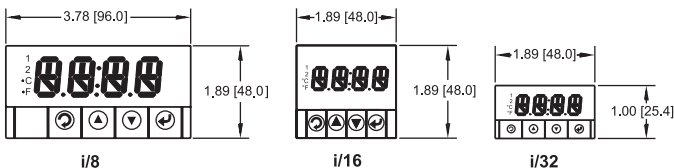

Figure 2.1 Front Panel Display

Table 2.1 Front Annunciators

1	Setpoint 1/ Alarm 1 indicator
2	Setpoint 2/ Alarm 2 indicator
°C	°C unit indicator
°F	°F unit indicator
	Changes display to Configuration Mode and advances through menu items*
	Used in Program Mode and Peak Recall*
	Used in Program Mode and Valley Recall*
	Accesses submenus in Configuration Mode and stores selected values*

\* See Part 3 Operation: Configuration Mode



## 2.2 Rear Panel Connections

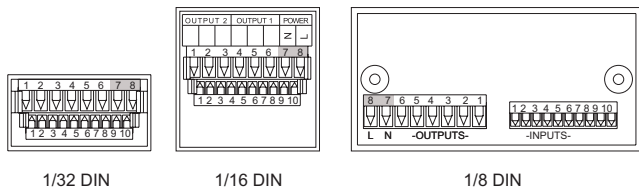

Figure 2.2 Rear Panel

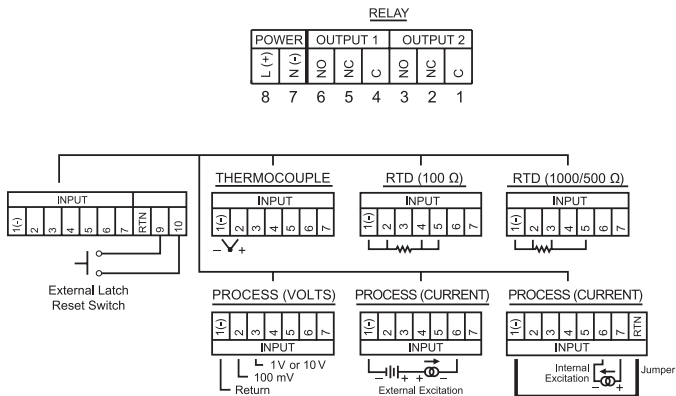

Figure 2.3 Rear Panel Input Connector Labels

Table 2.2 Rear Panel Connector

<b>POWER</b>	AC/DC Power Connector: All models
<b>INPUT</b>	Input Connector: All models TC, PR (Process), RTD
<b>ALARM 1 OUTPUT</b>	Mechanical Relay SPDT
<b>ALARM 2 OUTPUT</b>	Mechanical Relay SPDT
<b>OPTION</b>	Excitation, not available with low power option (-DC)

## 2.3 Electrical Installation

### 2.3.1 Power Connections



**Caution:** Do not connect power to your device until you have completed all input and output connections. Failure to do so may result in injury!

Connect the main power connections as shown in **Figure 2.4**.



Use copper conductors only for power connections

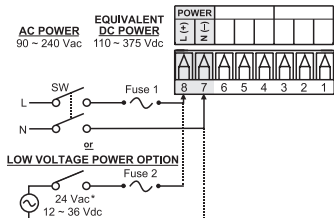

**Figure 2.4 Main Power Connections**

**Table 2.3 Power Connections**

FUSE	Connector	For 115 Vac	For 230 Vac	DC
FUSE 1	Power*	100 mA(T)	100 mA(T)	100 mA(T)
FUSE 2	Power*	N/A	N/A	400 mA(T)



For the low voltage power option, in order to maintain the same degree of protection as the standard high voltage input power units (90 to 240 Vac), always use a Safety Agency Approved DC or AC source with the same Overvoltage Category and pollution degree as the standard AC unit (90 to 240 Vac).



The Safety European Standard EN61010-1 for measurement, control, and laboratory equipment requires that fuses must be specified based on IEC127. This standard specifies for a Time-lag fuse, the letter code "T". The above recommended fuses are of the type IEC127-2-sheet III. Be aware that there are significant differences between the requirements listed in the UL 248-14/CSA 248.14 and the IEC 127 fuse standards. As a result, no single fuse can carry all approval listings. A 1.0 Amp IEC fuse is approximately equivalent to a 1.4 Amp UL/CSA fuse. It is advised to consult the manufacturer's data sheets for a cross-reference.

### 2.3.2 Thermocouple

The figure below shows the wiring hookup for any thermocouple type. For example, for Type K hookup, connect the yellow wire to the "2" terminal and the red wire to the "1(-)" terminal.

**When configuring your device, select Thermocouple and Thermocouple Type in the Input Type menu (see Part 3).**

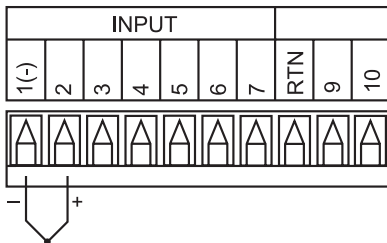

Figure 2.5 Thermocouple Wiring Hookup

Table 2.4 TC Wire Color Chart

Type	Input Connector		Jacket (External Insulation)	
	Terminal 1 (-)	Terminal 2 (+)	Extension	Grade
J	Red	White	Dark-Brown	Black
K	Red	Yellow	Dark-Brown	Yellow
T	Red	Blue	Dark-Brown	Blue
E	Red	Purple	Dark-Brown	Purple
N	Red	Orange	Dark-Brown	Brown
R	Red	Black	-	Green
S	Red	Black	-	Green
B	Red	Gray	-	Black

### 2.3.3 Two/Three/Four-Wire RTD

The figures below show the input connections and input connector jumpers (shown in bold lines) required to hookup a 2-, 3- or 4-wire RTD.

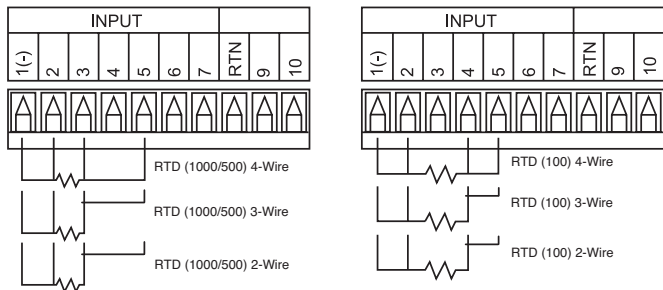

Figure 2.6 a) RTD-100 ohm and 500 ohm Wiring Hookup

b) RTD-100 ohm Wiring Hookup

The **two-wire** connection is simplest method, but does not compensate for lead-wire temperature change and often requires calibration to cancel lead-wire resistance offset.

The **three-wire** connection works best with RTD leads closely equal in resistance. The device measures the RTD, plus upper and lower lead drop voltage and the subtracts twice the measured drop in the lower supply current lead producing excellent lead-resistance cancellation for balanced measurements.

The **four-wire** RTD hookup is applicable to unbalanced lead resistance and enables the device to measure and subtract the lead voltage, which produces the best lead-resistance cancellation.

**When configuring your device, select RTD type and RTD value in the Input Type menu (see Part 3).**

**Note**

If the input wires of the meter get disconnected or broken, it will display  $\text{F} \text{ } \square \text{ } P \text{ } H$  "Input (+) Open" message except in case of 500/1000  $\Omega$  2-wire RTD. In this case the display shows  $\text{-} \text{ } \square \text{ } P \text{ } H$  "Input (-) Open" message. For safety purpose you may want to set up your alarm to be triggered when input is open. See Alarm 1 & 2 Sections 3.2.6, 3.2.7 for details.

### 2.3.4 Process Current

The figure below shows the wiring hookup for Process Current 0 – 20 mA.

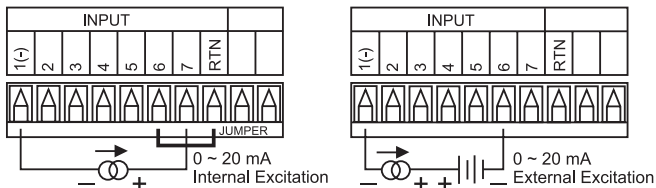
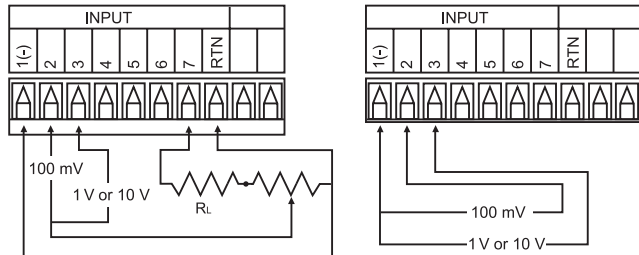

**Figure 2.7 Process Current Wiring Hookup (Internal and External Excitation)**

When configuring your device, select **Process Type** in the **Input Type Menu** (see Part 3).

### 2.3.5 Process Voltage

The figure below shows the wiring hookup for Process Voltage 0 – 100 mV, 0 – 1 V, 0 – 10 V.



**Figure 2.8 a) Process Voltage Wiring Hookup with Sensor Excitation**

**b) Process Voltage Wiring Hookup without Sensor Excitation**

$R_L$  - Voltage limited resistor, which allows to convert 24 Vdc internal excitation voltage to the appropriate process input value. For instance: if the potentiometer value is equal to 10 k $\Omega$ , the minimum  $R_L$  is 14 k $\Omega$  for 10 V process input.

When configuring your device, select **Process Type** in the **Input Type Menu** (see Part 3).

### 2.3.6 Wiring Outputs

This device has two factory installed outputs.  
The SPDT Mechanical Relay Connection is shown below.

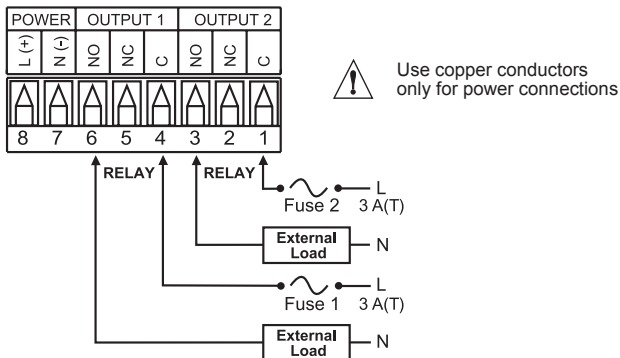

**Figure 2.9 Mechanical Relay Output Wiring Hookup**

## **PART 3**

# **OPERATION: Configuration Mode**

### **3.1 Introduction**

The device has two different modes of operation.

The first, Run Mode, is used to display values for the Process Variable, and to display or clear Peak and Valley values.

The other mode, Menu Configuration Mode, is used to navigate through the menu options and configure the device.

Part 3 of this manual will explain the Menu Configuration Mode. For your device to operate properly, the user must first “**program**” or configure the menu options.



















#### **Turning your device On for the First Time**

The device becomes active as soon as it is connected to a power source. It has no On or Off switch.

The device at first momentarily shows the software version number, followed by reset *R S t* , and then proceeds to the Run Mode.

### 3.1 Introduction (continued)

Table 3.1 Button Function in Configuration Mode

 (MENU)	<ul style="list-style-type: none"><li>• To enter the Menu, the user must first press  button.</li><li>• Use this button to advance/navigate to the next menu item. The user can navigate through all the top level menus by pressing .</li><li>• While a parameter is being modified, press  to escape without saving the parameter.</li></ul>
 (UP)	<ul style="list-style-type: none"><li>• Press the up  button to scroll through “flashing” selections. When a numerical value is displayed press this key to increase value of a parameter that is currently being modified.</li><li>• Holding the  button down for approximately 3 seconds will speed up the rate at which the set point value increments.</li><li>• In the Run Mode press  causes the display to flash the PEAK value – press again to return to the Run Mode.</li></ul>
 (DOWN)	<ul style="list-style-type: none"><li>• Press the down  button to go back to a previous Top Level Menu item.</li><li>• Press this button twice to reset the device to the Run Mode.</li><li>• When a numerical value is flashing (except set point value) press  to scroll digits from left to right allowing the user to select the desired digit to modify.</li><li>• When a setpoint value is displayed press  to decrease value of a setpoint that is currently being modified. Holding the  button down for approximately 3 seconds will speed up the rate at which the setpoint value is decremented.</li><li>• In the Run Mode press  causes the display to flash the VALLEY value – press again to return to the Run Mode.</li></ul>
 (ENTER)	<ul style="list-style-type: none"><li>• Press the enter  button to access the submenus from a Top Level Menu item.</li><li>• Press  to store a submenu selection or after entering a value — the display will flash a <i>S t R d</i> message to confirm your selection.</li><li>• To reset flashing Peak or Valley press .</li><li>• In the Run Mode, press  twice to enable Standby Mode with flashing <i>S t b d</i>.</li></ul>



**Reset:** Except for Alarms, modifying any settings of the menu configuration will reset the device prior to resuming Run Mode.



## 3.2 Menu Configuration

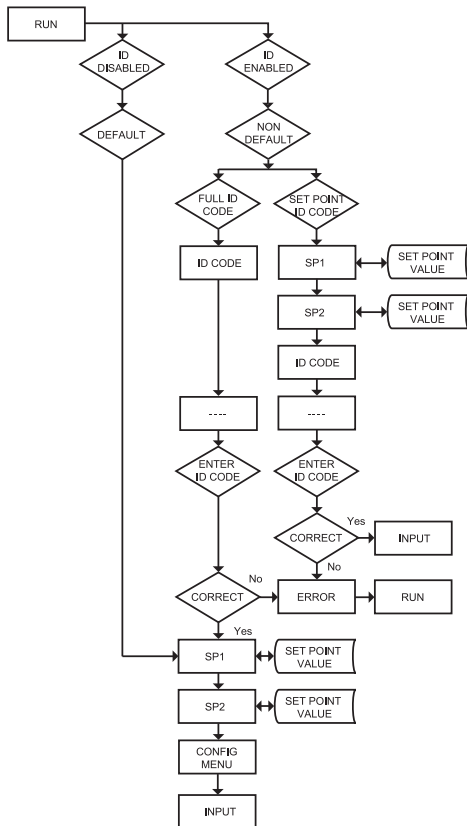

Figure 3.1 Flow Chart for ID and Set Points Menu

### 3.2.1 ID Number Menu

#### SEE ID MENU SELECTION IN CONFIGURATION SECTION FOR ENABLE/DISABLE OR CHANGE ID CODE.

**Note**

If ID Code is **Disabled** or set as **Default** (0000) the menu will skip ID step to Setpoint Menu.

If ID Code is set to **Full Security Level** and user attempts to enter the Main Menu, they will be prompted for an ID Code.

If ID Code is set to **Set Point/ID Security Level** and user attempts to enter the Configuration Menu, they will be prompted for an ID Code.

#### ENTERING YOUR NON-DEFAULT FULL SECURITY ID NUMBER.

- Press **⏏** 1) Display shows *Id*.  
Press **⏏** 2) Display advances to *----*  
Press **▲** & **▼** 3) Press **▲** to increase digit 0-9. Press **⏏** to activate next digit (flashing). Continue to use **▲** and **▼** to enter your 4-digit ID code.  
Press **⏏** 4) If the correct ID code is entered, the menu will advance to the Setpoint 1 Menu, otherwise an error message *ERR* will be displayed and the instrument will return to the Run Mode.

**Note**

To change ID Code, see ID Menu in the Configuration section.

#### ENTERING YOUR NON-DEFAULT SET POINT/ID SECURITY ID NUMBER.

- Press **⏏** 5) Display shows *SP 1* Setpoint 1 Menu.  
Press **⏏** 6) Display shows *SP 2* Setpoint 2 Menu.  
Press **⏏** 7) Display shows *Id* ID Code Menu.  
Press **⏏** 8) Display advances to *----*  
Press **▲** & **▼** 9) Use **▲** and **▼** to change your ID Code.  
Press **⏏** 10) If the correct ID code is entered, the display will advance to the *INPT* Input Menu, otherwise the error message *ERR* will be displayed and the unit will return to the Run Mode.

**Note**







To prevent unauthorized tampering with the setup parameters, the instrument provides protection by requiring the user to enter the ID Code before allowing access to subsequent menus. If the ID Code entered does not match the ID Code stored, the unit responds with an error message and access to subsequent menus will be denied.

**Note**

Use numbers that are easy for you to remember. If the ID Code is forgotten or lost, call customer service with your serial number to access and reset the default to *0000*.







## 3.2.2 Set Points Menu

### SETPOINT 1:

- Press  1) Press , if necessary until *SP 1* prompt appears.  
Press  2) Display shows previous value of "Setpoint 1".  
Press  &  3) Press  and  to increase or decrease Setpoint 1 respectively.



Holding  &  buttons down for approximately 3 seconds will speed up the rate at which the Setpoint value increments or decrements.



- Press  &  4) Continue to use  and  to enter your 4-digit Setpoint 1 value.  
Press  5) Display shows *Setpoint* stored message momentarily and then advance to *SP 2* only, if a change was made, otherwise press  to advance to *SP 2* Setpoint 2 Menu.

### SETPOINT 2:

- Press  6) Display shows previous value of "Setpoint 2".  
Press  &  7) Press  and  to increase or decrease Setpoint 2 respectively.



Holding  &  buttons down for approximately 3 seconds will speed up the rate at which the Setpoint value increments or decrements.

- Press  8) Display shows *Setpoint* stored message momentarily and then advance to *CFG* only, if a change was made, otherwise press  to advance to *CFG* Configuration Menu.



Setpoints are used for Deviation only.

### 3.2.3 Configuration Menu

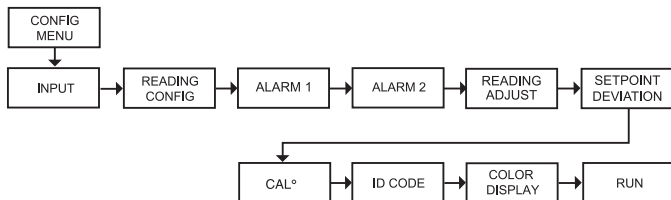

Figure 3.2 Flow Chart for Configuration Menu

#### ENTER CONFIGURATION MENU:

- Press **⏪**            1) Press **⏪**, if necessary until *C N F G* prompt appears.  
 Press **⏩**            2) Display advances to *I N P U T* Input Menu.  
 Press **⏪ & ⏩**        3) Press and release **⏪** to scroll through all available menus of Configuration section.

### 3.2.4 Input Type Menu

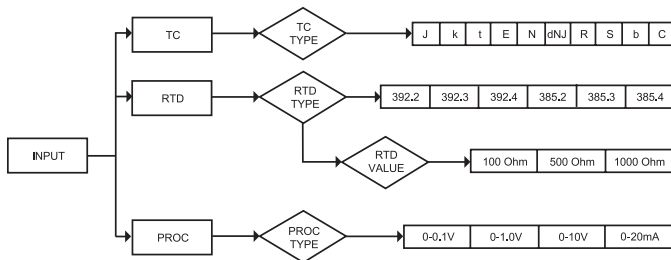

Figure 3.3 Flow Chart for Input Type Menu

### 3.2.4.1 Input Type (Thermocouple)

#### ENTER INPUT TYPE MENU:

- Press **⏪**      1) Press **⏪**, if necessary until **CFG** prompt appears.  
Press **⏩**      2) Display advances to **INPUT** Input Menu.  
Press **⏩**      3) Display flashes **t.c.**, **RTD** or **PRC** (Thermocouple, RTD or Process). If the displayed input type is **t.c.**, press **⏩** to skip to step 6 (**t.c.** stops flashing).

#### THERMOCOUPLE SUBMENU:

- Press **⏪**      4) Scroll through the available selection to **t.c.** (flashing).  
Press **⏩**      5) Display shows **StRd** stored message momentarily and then **t.c.** (not flashing).  
Press **⏩**      6) Display flashes previous thermocouple type selection. i.e. **J** (see below for types).  
Press **⏪**      7) Scroll through the available thermocouple types to the selection of your choice.  
Press **⏩**      8) Display shows **StRd** stored message momentarily and then advances to the **RdC** Reading Configuration Menu.







Use the Input Type (Thermocouple) (RTD) or (Process) and verify your Electrical Installation (see **Section 2.3**).





**Thermocouple Types:** J, K, T, E, N, DIN J, R, S, B, C  
**Display:**            J K E E N dN J R S b C

### 3.2.4.2 Input Type (RTD)

#### ENTER INPUT TYPE MENU:

- Press  1) Press , if necessary until *C N F G* prompt appears.  
Press  2) Display advances to *I N P U T* Input Menu.  
Press  3) Display flashes *t.c.*, *R t d* or *P R O C* (Thermocouple, RTD or Process). If the displayed input type is *R t d*, press  to skip to step 6 (*R t d* stops flashing).

#### RTD SUBMENU:



- Press  4) Scroll through the available selection to *R t d* (flashing).  
Press  5) Display shows *S t R d* stored message momentarily and then *R t d* (not flashing).  
Press  6) Display flashes previous RTD type selection i.e. *3 9 2 . 2* (see below for RTD types selection).  
Press  7) Scroll through the available RTD types to the selection of your choice.  
Press  8) Display shows *S t R d* stored message momentarily and then advances to the *R t d* RTD value.

**RTD Types:** 392 385 Two, Three or Four wire  
**Display:** 392.2, 392.3, 392.4, 385.2, 385.3, 385.4

 Note

Last digit indicates: 2-, 3- or 4-wire input.

#### RTD VALUE SUBMENU:

- Press  9) Display flashes previous RTD value selection i.e. *1 0 0 \_* (see below for RTD value selection).  
Press  10) Scroll through the available RTD values to the selection of your choice.  
Press  11) Display shows *S t R d* stored message momentarily and then advances to *R d C* Reading Configuration Menu.

**RTD Values:** 100 OHM 500 OHM 1000 OHM  
**Display:** 100 \_ 500 \_ 1000

### 3.2.4.3 Input Type (Process)

#### ENTER INPUT TYPE MENU:

- Press **⏪** 1) Press **⏪**, if necessary until *C N F G* prompt appears.  
Press **⏩** 2) Display advances to *I N P U T* Input Menu.  
Press **⏩** 3) Display flashes *t . c .*, *R T D* or *P R D C* (Thermocouple, RTD or Process). If the displayed input type is *P R D C*, press **⏩** to skip to step 6 (*P R D C* stops flashing).

#### PROCESS SUBMENU:

- Press **⏩** 4) Scroll through the available selection to *P R D C* (flashing).  
Press **⏩** 5) Display shows *S t R d* stored message momentarily and then *P R D C* (not flashing).  
Press **⏩** 6) Display flashes previous Process type selection i.e. *0 - 1 0* (see below for Process types selection).  
Press **⏩** 7) Scroll through the available Process types to the selection of your choice.  
Press **⏩** 8) Display shows *S t R d* stored message momentarily and then advances to the *R d C* Reading Configuration Menu.

<b>Process Types:</b>	100 mV	1 V	10 V	0 to 20 mA
<b>Display:</b>	0 - 0 . 1	0 - 1 . 0	0 - 1 0	0 - 2 0

For 4 to 20 mA Input select 0 to 20 mA then adjust the Input/Reading accordingly. To adjust 4 to 20 mA input, see example under INPUT/READING Submenu. The factory preset value is 4 to 20 mA.

### 3.2.5 Reading Configuration Menu

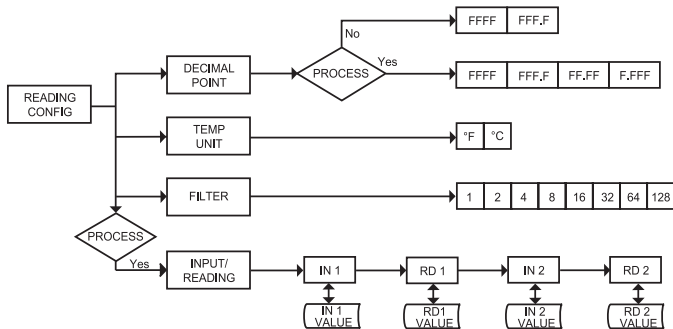

Figure 3.4 Flow Chart for Reading Configuration Menu

#### ENTER READING CONFIGURATION MENU:

- Press **⏪** 1) Press **⏪**, if necessary until **CFG** prompt appears.  
 Press **⏩** 2) Display advances to **INPUT** Input Menu.  
 Press **⏪** 3) Press and release **RC** Reading Configuration Menu.  
 Press **⏩** 4) Display advances to **DEC** Decimal Point.

#### DECIMAL POINT SUBMENU:



- Press **⏩** 5) Display flashes previous selection for Decimal location.  
 Press **⏪** 6) Scroll through the available selections and choose Decimal location: **FFFF** or **FFF.F** (also **FF.FF** and **F.FFF** — if **PROC** Process type was selected in the Input Type Menu).  
 Press **⏩** 7) Display shows **StRd** stored message momentarily and then advances to **TEMP** Temperature Unit.

**Note** Decimal Point for Process Input Type is passive.







### 3.2.5 Reading Configuration Menu (continued)

#### TEMPERATURE UNIT SUBMENU:

- Press  8) Display flashes previous Temperature Unit selection.
- Press  9) Scroll through the available selections to the Temperature Unit of your choice: °F or °C.
- Press  10) Display shows *StRd* stored message momentarily and then advances to *FLtR* Filter Constant.

#### FILTER CONSTANT SUBMENU:

- Press  11) Display flashes previous selection for Filter Constant.
- Press  12) Scroll through the available selections:  
*0001, 0002, 0004, 0008, 0016, 0032, 0064, 0128*
- Press  13) Display shows *StRd* stored message momentarily only, if change were made, otherwise press  to advance to the next menu.



If Process was selected in the Input Type Menu the display will advance to *IN.Rd* Input/Reading Submenu, otherwise the display advances to the *ALR1* Alarm 1 Menu.

The Filter Constant Submenu allows the user to specify the number of readings stored in the Digital Averaging Filter. A filter value of 2 is approximately equal to 1 second RC low pass time constant.

## 3.2.5 Reading Configuration Menu (continued)

### Reading Configuration (If Process was selected)

#### INPUT/READING (SCALE AND OFFSET) SUBMENU:

Input Voltage or Current can be converted or scaled into values appropriate for the process or signal being measured. So, a reading may be displayed, for example, in units of weight or velocity instead of in amperes or volts.

The instrument determines Scale and Offset values based on two user-provided input values entered with the corresponding readings. Note that “In1” Input 1 and “In2” Input 2 are represented and entered as a product of the input voltage/current and the conversion number from the **Table 3.1**.

**Note**

The following instructions include details for a specific scenario in which a 4-20 mA input (in the 20 mA Process Mode) is to be represented as a measurement of 0-100 percent.

- Press **↵**      **14)** Press **↵** at the *IN.Rd* prompt. Display shows *IN 1* Input 1 submenu.
- Press **↵**      **15)** Display shows Input 1 value with first digit flashing.
- Press **▲ & ▼**      **16)** Use **▲** and **▼** buttons to enter *IN 1* value.  
The *IN 1* value = min. input value \* conversion number.

**Note**

Disregard the position of the decimal point (2000 counts may actually appear as “200.0”, “20.00”, or “2.000”).  
Example: 4 mA as  $4(\text{mA}) \times 500 = 2000$ .

- Press **↵**      **17)** Display advances to *Rd 1* Reading 1 Submenu.
- Press **▲ & ▼**      **18)** Use **▲** and **▼** buttons to enter *Rd 1* value.  
This value represents *IN 1* in terms of some meaningful engineering units. To show the 4 mA as zero percent enter *Rd 1* value = 0000.  
Example: RD 1 value = 0000.
- Press **↵**      **19)** Display shows *IN 2* Input 2 Submenu.
- Press **↵**      **20)** Display shows Input 2 value with first digit flashing.  
The *IN 2* value = max. input value \* conversion number.  
Example:  $20(\text{mA}) \times 500 = 10000$  (9999).
- Press **▲ & ▼**      **21)** Use **▲** and **▼** buttons to enter *IN 2* value.
- Press **↵**      **22)** Display advances to *Rd 2* Reading 2 Submenu.
- Press **▲ & ▼**      **23)** Use **▲** and **▼** buttons to enter *Rd 2* value.  
Example: RD 2 value = 0100.
- Press **↵**      **24)** Display flashes *Set Rd* stored message momentarily and then advances to *AL R 1* only, if change were made, otherwise press **↵** to advance to *AL R 1* Alarm 1 Menu.

### 3.2.5 Reading Configuration Menu (continued)



Conversion number is a coefficient of conversion between input values and real full display range (10000 counts). See **Table 3.2** below for proper conversion number.

**Table 3.2 Conversion Table**

<b>RANGE</b>	<b>CONVERSION NUMBER</b>
100 mV	$10000 / (100 \times 1) = 100$
1 V	$10000 / (1000 \times 1) = 10$
10 V	$10000 / (10000 \times 10) = 1$
0 to 20 mA	$10000 / (20 \times 1) = 500$

Example =

$$0 - 1 \text{ V} = 0 - 100.0$$

$$\text{In 1} = 0$$

$$\text{Rd 1} = 0$$

$$\text{Inp 2} = 9999$$

$$\text{Rd 2} = 100.0$$

### 3.2.6 Alarm 1 Menu

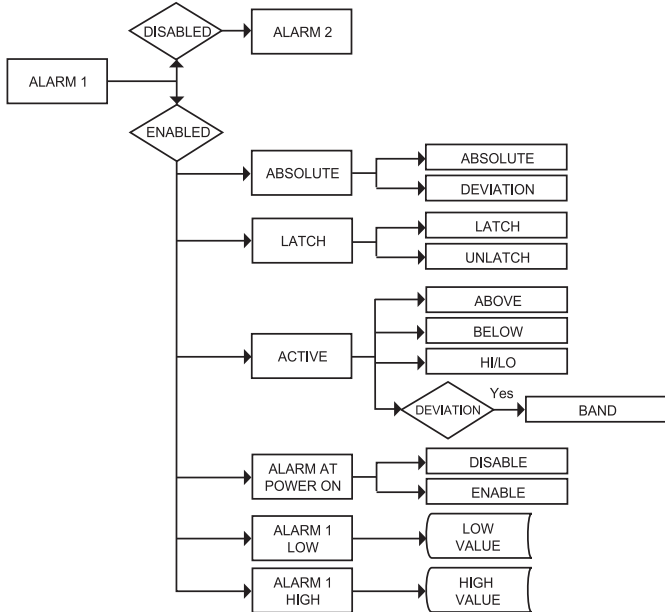

Figure 3.5 Flow Chart for Alarm 1 Menu

#### ENTER ALARM 1 MENU:

- Press 1) Press , if necessary until *C N F G* prompt appears.
- Press 2) Display advances to *I N P U T* Input Menu.
- Press 3) Press , if necessary, until display advances to *A L A R M 1* Alarm 1 Menu.
- Press 4) Display advances to Alarm 1 *E N A B L E* Enable or *D I S A B L E* Disable Submenu and flashes the previous selection.

### 3.2.6 Alarm 1 Menu (continued)

#### ALARM 1 ENABLE/DISABLE SUBMENU:

- Press **⏪** 5) Scroll through the available selection until **ENBL** displays to use Alarm 1.
- Press **⏩** 6) Display shows **SETRd** stored message momentarily and then advances to **ABSO** only if it was changed, otherwise press **⏩** to advance to **ABSO** Alarm 1 Absolute/Deviation Submenu.



If **dSbL** Alarm 1 **Disabled** was selected, all submenus of Alarm 1 Menu will be skipped and meter advances to **RLR2** Alarm 2 Menu.

#### ALARM 1 ABSOLUTE/DEVIATION SUBMENU:

- Press **⏪** 7) Display flashes previous selection. Press **⏪** to **ABSO** Absolute or **-dEY** Deviation.
- Press **⏩** 8) Display shows **SETRd** stored message momentarily and then advances to **LtCH** only if it was changed, otherwise press **⏩** to advance to **LtCH** Alarm 1 Latch/Unlatch Submenu.

**Absolute Mode** allows Alarm 1 to function independently from Setpoint 1. If the process being monitored does not change often, then “Absolute” Mode is recommended.

**Deviation Mode** allows changes to Setpoint 1 to be made automatically to Alarm 1. Deviation Mode is typically the ideal mode if the process temperature changes often. In Deviation Mode, set Alarm 1 a certain number of degrees or counts away from Setpoint 1 — this relation remains fixed even if Setpoint 1 is changed.

#### ALARM 1 LATCH/UNLATCH SUBMENU:

- Press **⏪** 9) Display flashes previous selection. Press **⏪** to **LtCH** Latched or **UNLk** Unlatched.
- Press **⏩** 10) Display shows **SETRd** stored message momentarily and then advances to **ACTY** only, if it was changed, otherwise press **⏩** to advance to **ACTY** Active Submenu.

**Latched Mode:** Alarm remains “latched” until reset. To reset already latched alarm, select Alarm Latch and press Max twice (i.e. Unlatch and then back to Latch) or from a Run Mode, push **⏪** twice to put the monitor in Standby Mode and then push **⏪** one more time to return to the Run Mode.

**Unlatched Mode:** Alarm remains latched only as long as the alarm condition is true.

### 3.2.6 Alarm 1 Menu (continued)

#### ACTIVE SUBMENU:

- Press **⏪** **11)** Display flashes previous selection. Press **⏩** to scroll through the available selections: *ABOVE* Above, *BELOW* Below, *HIL* HI/Low and *BAND* Band. (Band is active if *DEV* Deviation was selected).
- Press **⏩** **12)** Display shows *SetPt* stored message momentarily and then advances to *R.P.* only if it was changed, otherwise press **⏩** to advance to *R.P.* Alarm Enable/Disable at Power On Submenu.

**Above:** Alarm 1 condition triggered when the process variable is greater than the Alarm Hi Value (Low value ignored).

**Below:** Alarm 1 condition triggered when the process variable is less than the Alarm Low Value (Hi value ignored).

**Hi/Low:** Alarm 1 condition triggered when the process variable is less than the Alarm Low Value or above the Hi Value.

**Band:** Alarm 1 condition triggered when the process variable is above or below the “band” set around Setpoint 1. Band equals Hi Value (Low Value ignored). A “band” is set around the set point by the instrument only in the “Deviation” Mode.

The Band for the AL 1 would be following the Setpoint 1 value.

The Band for the AL 2 would be following the Setpoint 2 value.

The Band or the Deviation Value should be entered under:

AL1 High (if they want Alarm 1)

AL2 High (if they want Alarm 2)

AL Low value is ignored in the Band mode.

**Example:** if customer requires a Deviation Value of  $\pm 10$  degrees around a setpoint (using Output 2 as alarm)

Alarm 2: - Deviation

Contact Closure type: Deviation -- Band

AL2 High: 10 (Band they want around Setpoint 2)

Then the Band Value is to be entered under AL2 HI: 10 not  $80 + 10 = 90$

### 3.2.6 Alarm 1 Menu (continued)

#### ALARM ENABLE/DISABLE AT POWER ON:

- Press **↵** **13)** Display flashes previous selection. Press **↵** to *ENBL* enable or *DSBL* disable.
- Press **↵** **14)** Display shows *SE Rd* stored message. momentarily and then advances to *ALR.L* only if it was changed, otherwise press **↵** to advance to the *ALR.L* Alarm 1 Low Value Submenu.



If the alarm is enabled at Power On, the alarm will be active right after reset. If the alarm is disabled at Power On, the alarm will become enabled when the process value enters the non alarm area. The alarm is not active while the process value is approaching Setpoint 1.

#### ALARM 1 LOW VALUE SUBMENU:

- Press **↵** **15)** Display flashes first digit of previous value. Use **▲** and **▼** to enter new value.
- Press **▲** & **▼** **16)** Use **▲** and **▼** to enter Alarm 1 Low Value.
- Press **↵** **17)** Display shows *SE Rd* storage message momentarily and then advances to *ALR.H* only, if it was changed, otherwise press **↵** to advance to *ALR.H* Alarm 1 Hi Value Submenu.

#### ALARM 1 HI VALUE SUBMENU:

- Press **↵** **18)** Display flashes first digit of previous value. Use **▲** and **▼** to enter new value.
- Press **▲** & **▼** **19)** Use **▲** and **▼** to enter Alarm 1 Hi Value.
- Press **↵** **20)** Display shows *SE Rd* stored message momentarily and then advances to the next menu only, if it was changed, otherwise press **↵** to advance to the next menu.

### 3.2.7 Alarm 2 Menu

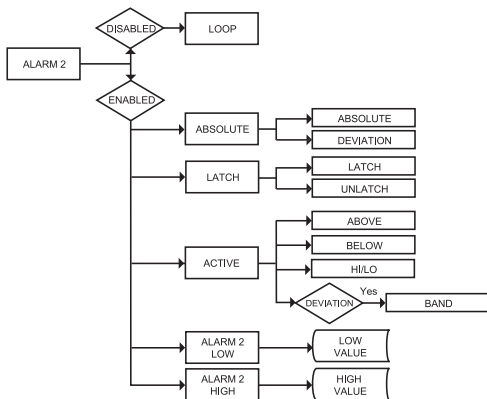

Figure 3.6 Flow Chart for Alarm 2 Menu

#### ENTER ALARM 2 MENU:

- Press **⏏** 1) Press **⏏**, if necessary until **CFG** prompt appears.  
Press **⏏** 2) Display advances to **INPUT** Input Menu.  
Press **⏏** 3) Press **⏏**, if necessary, until display advances to **ALR 1**  
Alarm 2 Menu.  
Press **⏏** 4) Display advances to Alarm 2 **ENBL** Enable or **DSBL** Disable Submenu.

#### ALARM 2 ENABLE/DISABLE SUBMENU:

- Press **⏏** 5) Display flashes previous selection. Press **⏏** until **ENBL** displays to use Alarm 2.  
Press **⏏** 6) Display shows **STRD** stored message momentarily and then advances to **ABS0** only if it was changed, otherwise press **⏏** to advance to **ABS0** Absolute/Deviation Submenu.

If **DSBL** Alarm 2 **Disabled** was selected, all submenus of Alarm 2 Menu will be skipped and meter advances to **R.Rd J** Cold Junction (C.J.) Reading Adjust Menu.



The remaining Alarm 2 menu items are identical to Alarm 1 Menu. Modifying Alarm Settings will not reset the instrument.



### 3.2.8 Reading Adjust Menu

**Note** For Temperature Reading only, not Process



Figure 3.7 Flow Chart for Reading Adjust Menu

#### ENTER READING ADJUST MENU:

- Press **⏏** 1) Press **⏏**, if necessary, until **CFG** prompt appears.
- Press **⏏** 2) Display advances to **INP** Input Menu.
- Press **⏏** 3) Press **⏏**, if necessary, until display advances to **R.ADJ** Reading Adjust Menu.

#### READING ADJUST VALUE SUBMENU:

- Press **⏏** 4) Display flashes first digit of previous Reading Adjust value.
- Press **▲** & **▼** 5) Press **▲** and **▼** buttons to enter a new Reading Adjust value (-1999 to 9999).
- Press **⏏** 6) Display shows **Set Rd** stored message momentarily and then advances to **SP.dV** Setpoint Deviation Menu.

**Reading Offset Adjust** allows the user to fine tune a minor error of the transducer, however some applications may require a large offset adjust. (Displayed Process Value = Measured Process Value  $\pm$ R.ADJ). Reading Adjust value is adjustable between -1999 to 9999.

### 3.2.9 Setpoint Deviation Menu / Field Calibration

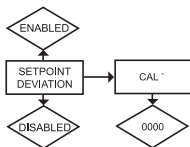



Figure 3.8 Flow Chart for Setpoint Deviation Menu / Field Calibration

#### ENTER SETPOINT DEVIATION MENU:

- Press **⏏** 1) Press **⏏**, if necessary, until **CFG** prompt appears.
- Press **⏏** 2) Display advances to **INP** Input Menu.
- Press **⏏** 3) Press **⏏**, if necessary, until Display advances to **SP.dV** Setpoint Deviation Menu.

### 3.2.9 Setpoint Deviation Menu / Field Calibration (continued)

#### ENTER READING ADJUST MENU:

- Press  4) Display advances to Setpoint Deviation *ENBL* Enable or *dsbl*. Disable Submenu and flashes the previous selection.
- Press  5) Scroll through the available selections: *ENBL* or *dsbl*.
- Press  6) Display shows *SLRD* stored message momentarily and then advances to the next menu item.

**Setpoint Deviation** menu, if “enabled”, allows changes to Setpoint 1 to be made automatically to Setpoint 2. This mode is very helpful if the Process value changes often.

In Setpoint Deviation Mode, set SP2 a certain number of degrees or counts away from SP1 - this relation remains fixed when SP1 is changed.

For instance: Setting SP1=200 and SP2=20 and enabling *SP.dU* means that the absolute value of SP2=220.

Moving SP1 to 300, the absolute value of SP2 becomes 320.

#### THERMOCOUPLE FIELD CALIBRATION SUBMENU:



**CAUTION:** Do not perform the following steps until you fully understand this entire section.





**Note**

RTD and Process are perfectly calibrated. This section is applicable to Thermocouple (TC) calibration *only*.

Be sure that the TC being used to calibrate the meter is of the type selected in the TC submenu. Place the TC in an ice-bath (or other **0°C / 32°F** environment). In ambient temperature conditions: connect the TC to the meter, apply power to the meter.



**CAUTION:** Do not proceed with TC calibration unless the above conditions have been in effect for at least one hour.

- Press  7) Display shows *CAL I*.
- Press  8) Display shows flashing *0000*.
- Press  \* 9) Display will still show flashing *0000*.
- Press  \* 10) Display shows *OUT I* (meaning Calibration is complete)

**Note**

\* If you accidentally engage the flashing **0000 (CAL° alert)** simply re-press the last button you pressed, to avoid unintentionally mis-calibrating your meter.

### 3.2.10 ID Code Menu

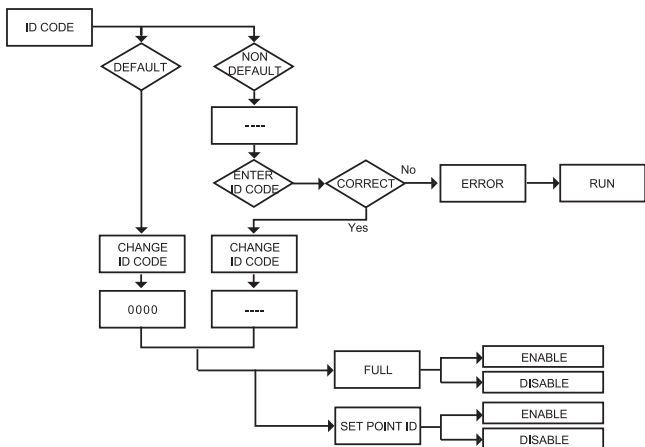

Figure 3.6 Flow Chart for Alarm 2 Menu

#### ENTER ID CODE MENU:

- Press **⏏** 1) Press **⏏**, if necessary, until *CHFG* prompt appears.
- Press **⏏** 2) Display advances to *INPt* Input Menu.
- Press **⏏** 3) Press **⏏**, if necessary, until display advances to *Id* ID Code Menu.

#### ENTERING OR CHANGING YOUR (NON-DEFAULT) ID CODE:

- Press **⏏** 4) Display advances to *----* with first under score flashing.
- Press **▲** & **▼** 5) Press **▲** and **▼** to enter your 4-digit "ID Code" number.
- Press **⏏** 6) Display advances to *CH. Id* Change ID Code Submenu.





If entered "ID Code" is incorrect display shows *ERRo* Error message momentarily and then skips to the Run Mode.

- Press **⏏** 7) Display flashes the first digit of previous entered "ID Code" number.
- Press **▲** & **▼** 8) Press **▲** and **▼** buttons to enter your new "ID Code" number.
- Press **⏏** 9) Display shows *Setd* stored message momentarily and then advances to the *FULL* Full Security Submenu.





## ENTERING OR CHANGING YOUR (DEFAULT) ID CODE:

Enter *Id* menu (Repeat steps from 1 to 3).



- Press  **10)** Display advances to *CH. Id* Change ID Code Submenu.  
Press  **11)** Display shows *0000* message with flashing first digit.

 **Note**

If you want to change your default “ID Code” you can do it now, otherwise press  and menu will skip to *FULL* Full Security Submenu.

- Press  &  **12)** Press  and  buttons to enter your new “ID Code” number.  
Press  **13)** Display shows *SEId* stored message momentarily and then advances to the *FULL* Full Security Submenu.

## FULL SECURITY LEVEL SUBMENU:

- Press  **14)** Display flashes *ENbL* Enable or *dsbL* Disable.  
Press  **15)** Scroll through the available selections: “Enable” or “Disable”.  
Press  **16)** Display shows *SEId* stored message momentarily and then advances to *SP. Id* Setpoint/ID Submenu.



 **Note**

If “Full” Security Level is “Enabled” and the user attempts to enter the Main Menu, they will be prompted for an ID Code. The ID Code should be correct to enter the instrument Menu item.

## SETPOINT/ID SECURITY LEVEL SUBMENU:

 **Note**

This Security Level can be functional only if *FULL* Security Level is Disabled.

- Press  **17)** Display flashes *ENbL* Enable or *dsbL* Disable.  
Press  **18)** Scroll through the available selections: “Enable” or “Disable”.  
Press  **19)** Display shows *SEId* stored message momentarily and then advances to *CFG* Communication Submenu.

 **Note**

If “**Setpoint/ID**” Security Level is “**Enabled**” and the user attempts to advance into the *CFG* Configuration Menu, he will be prompted for ID Code number. The ID Code should be correct to proceed into the Configuration Menu, otherwise display will show an Error and skip to the Run Mode.

 **Note**

If “**Full**” and “**Setpoint/ID**” Security Levels are “**Disabled**”, the ID code will be “Disabled” and user will not be asked for ID Code to enter the Menu items (“ID” Submenu will not show up in “ID/Setpoint” Menu).

### 3.2.12 Display Color Selection Menu

This submenu allows the user to select the color of the display.

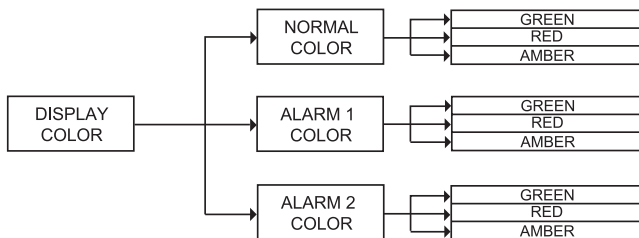

Figure 3.11 Flow Chart for Display Color Selection Menu

#### ENTER DISPLAY COLOR SELECTION MENU:

- Press **⏏** 1) Press **⏏**, if necessary, until *CONF* prompt appears.
- Press **⏏** 2) Display advances to *INP* Input Menu.
- Press **⏏** 3) Press **⏏**, if necessary, until display advances to *COLR* Display Color Selection Menu.
- Press **⏏** 4) Display advances to *NCLR* Normal Color Submenu.

#### NORMAL COLOR DISPLAY SUBMENU:



- Press **⏏** 5) Display flashes the previous selection for "Normal Color".
- Press **⏏** 6) Scroll through the available selections: *GRN*, *RED* or *AMBR*.
- Press **⏏** 7) Display shows *STRD* stored message momentarily and then advances to *ICLR* only, if it was changed, otherwise press **⏏** to advance to *ICLR* Alarm 1 Display Color Submenu.

The menu below allows the user to change the color of display when alarm is triggered.

#### ALARM 1 DISPLAY COLOR SUBMENU:

- Press **⏏** 8) Display flashes previous selection for "Alarm 1 Color Display".
- Press **⏏** 9) Scroll through the available selections: *GRN*, *RED* or *AMBR*.
- Press **⏏** 10) Display shows *STRD* stored message momentarily and then advances to *ICLR* only, if it was changed, otherwise press **⏏** to advance to *ICLR* Alarm 2 Display Color Submenu.

## ALARM 2 DISPLAY COLOR SUBMENU:

- Press  11) Display flashes previous selection for “Alarm 2 Color Display”.  
Press  12) Scroll through the available selections: *GRN*, *RED* or *AMB*.  
Press  13) Display shows *SEt* stored message momentarily and then momentarily shows the software version number, followed by *RS* Reset, and then proceeds to the Run Mode.

Note 

IN ORDER TO DISPLAY ONE COLOR, SET THE SAME DISPLAY COLOR ON ALL THREE SUBMENUS ABOVE.

Note 

If user wants the display to change color every time that both Alarm 1 and Alarm 2 are triggered, the Alarm values should be set in such a way that Alarm 1 value is always on the top of Alarm 2 value, otherwise value of Alarm 1 will overwrite value of Alarm 2 and Display Color would not change when Alarm 2 is triggered.

### Example 1:

Alarm Setup: Absolute, Above, Alarm 2 HI Value “ALR.H” = 212, Alarm 1 Below, LO Value “ALR.L” = 32

Color Display Setup: Normal Color “N.CLR” = Green, Alarm 1 Color “1.CLR” = Amber, Alarm 2 Color “2.CLR” = Red

### Display Colors change sequences:

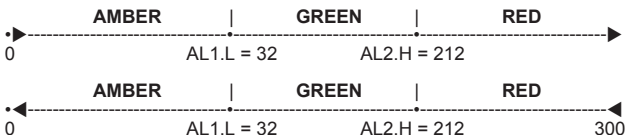

### Example 2:

Alarm Setup: Absolute, Below, Alarm 2 Low Value “ALR.L” = 300, Alarm 1 Low Value “ALR.L” = 100

Color Display Setup: “N.CLR” = Green, “1.CLR” = Amber, “2.CLR” = Red

### Display Colors change sequences:

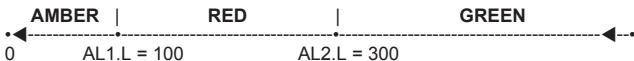

**Example 3:**

Setpoint 1 = 300,

Setpoint 2 = 200

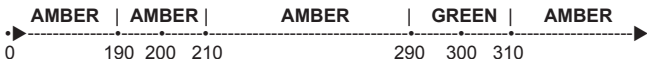
Alarm 1 & 2 Setup: Deviation, Band, "ALR.H" = 10Color Display Setup: "N.CLR" = Green, "1.CLR" = Amber, "2.CLR" = Red**Display Colors change sequences:****Note**

Alarm 1 is designed to monitor the Process Value around the Setpoint 1. Alarm 2 is designed to monitor the Process Value around the Setpoint 2.

**Example 4:**

Setpoint 1 = 200

Setpoint 2 = 200

Alarm 1 Setup: Deviation, Band, "ALR.H" = 20Alarm 2 Setup: Deviation, Hi/Low, "ALR.H" = 10, "ALR.L" = 5Color Display Setup: "N.CLR" = Green, "1.CLR" = Amber, "2.CLR" = Red**Display colors change sequences:****Note**

**Reset:** The instrument automatically resets after the last menu of the Configuration Mode has been entered. After the instrument resets, it advances to the Run Mode.

## **PART 4 SPECIFICATIONS**

### **Accuracy:**

$\pm 0.5^{\circ}\text{C}$  temp; 0.03% reading process

**Resolution:**  $1^{\circ}/0.1^{\circ}$ ; 10  $\mu\text{V}$  process

### **Temperature Stability:**

- 1) RTD:  $0.04^{\circ}\text{C}/^{\circ}\text{C}$
- 2) TC @  $25^{\circ}\text{C}$  ( $77^{\circ}\text{F}$ ):  $0.05^{\circ}\text{C}/^{\circ}\text{C}$   
- Cold Junction Compensation
- 3) Process: 50 ppm/ $^{\circ}\text{C}$

**NMRR:** 60 dB

**CMRR:** 120 dB

**A/D Conversion:** Dual slope

**Reading Rate:** 3 samples per second

**Digital Filter:** Programmable

### **Display:**

Single 4-digit, 9-segment LED,  
• 10.2 mm (0.40") for 1/16, 1/32 DIN;  
• 21 mm (0.83") for 1/8 DIN.  
Red, green and amber programmable  
colors for process variable, setpoint  
and temperature units

**Warm up to Rated Accuracy:** 30 min.

## **INPUT**

**Input Types:** Thermocouple, RTD,  
Analog Voltage, Analog Current

### **Thermocouple Type (ITS 90):**

J, K, T, E, R, S, B, C, N, L (J DIN)

### **Thermocouple Lead Resistance:**

100 ohm max

### **RTD Input (ITS 68):**

100/500/1000  $\Omega$  Pt sensor, 2-, 3- or  
4-wire; 0.00385 or 0.00392 curve

### **Voltage Input:**

0 to 100 mV, 0 to 1 V, 0 to 10 Vdc

### **Input Impedance:**

10 M $\Omega$  for 100 mV

1 M $\Omega$  for 1 or 10 Vdc

### **Current Input:**

0 to 20 mA (5 ohm shunt)

**Configuration:** Single-ended

**Polarity:** Unipolar

**Step Response:** 0.7 sec for 99.9%

### **Decimal Selection:**

None, 0.1 for temperature;  
None, 0.1, 0.01 or 0.001 for process

### **Setpoint Adjustment:**

-1999 to 9999 counts

### **Span Adjustment:**

0.001 to 9999 counts

### **Offset Adjustment:**

-1999 to +9999

## **ALARM 1 & 2 OUTPUTS**

Programmable to display color change

### **Relay:** SPDT, 250 Vac or

30 Vdc @ 3 A (Resistive Load)

**Operation** High/low, above/below,  
band, latch/unlatch, normally open/  
normally closed and process/deviation;  
front panel configurations

## **EXCITATION**

24 Vdc @ 25 mA

Not available with Low Power Option



## INSULATION

### Power to Input/Output

2300 Vac per 1 min. test  
1500 Vac per 1 min. test  
(Low Voltage/Power Option)

### Power to Relay Outputs

2300 Vac per 1 min. test

### Relay to Relay Outputs

2300 Vac per 1 min. test

## GENERAL

### Line Voltage/Power:

90 to 240 Vac +/-10%, 50 to 400 Hz\*  
110 to 375 Vdc, equivalent voltage;**4 W**

\* No CE compliance above 60 Hz

### Low Voltage/Power Option:

12 to 36 Vdc; **3 W\*\***

External power source must meet  
Safety Agency Approvals.

\*\* Units can be powered safely with 24 Vac  
power but, no Certification for CE/UL are  
claimed.

### External Fuse Required:

Time-Delay, UL 248-14 listed:  
100 mA/250 V  
400 mA/250 V (Low Voltage/Power  
Option)

Time-Lag, IEC 127-3 recognized:  
100 mA/250 V  
400 mA/250 V (Low Voltage/Power  
Option)

### Environmental Conditions:

0 to 55°C (32 to 131°F),  
90% RH non-condensing

### Protection:

NEMA-4x/Type 4x/IP65 front bezel:  
for 1/16, 1/32 DIN

NEMA-1/Type 1 front bezel: for 1/8 DIN

**Approvals** FM, UL, C-UL, and  
see CE Approval Section

## Dimensions

1/8 DIN: 48 H x 96 W x 127 mm D  
(1.89 x 3.78 x 5")

1/16 DIN: 48 H x 48 W x 127 mm D  
(1.89 x 1.89 x 5")

1/32 DIN: 25.4 H x 48 W x 127 mm D  
(1.0 x 1.89 x 5")

### Panel Cutout:

1/8 DIN: 45 H x 92 mm W  
(1.772" x 3.622"),

1/16 DIN: 45 mm (1.772") square

1/32 DIN: 22.5 H x 45 mm W  
(0.886" x 1.772")

### Weight:

1/8 DIN Series: 295 g (0.65 lb)

1/16 DIN Series: 159 g (0.35 lb)

1/32 DIN Series: 127 g (0.28 lb)

**Table 4.1 Input Properties**

TC	Input Type	Range	Accuracy*
<b>J</b>	Iron-Constantan	-210 to 760°C	0.4°C
		-346 to 1400°F	0.7°F
<b>K</b>	CHROMEQA®-ALOMEGA®	-270 to -160°C	1.0°C
		-160 to 1372°C	0.4°C
		-454 to -256°F	1.8°F
		-256 to 2502°F	0.7°F
<b>T</b>	Copper-Constantan	-270 to -190°C	1.0°C
		-190 to 400°C	0.4°C
		-454 to -310°F	1.8°F
		-310 to 752°F	0.7°F
<b>E</b>	CHROMEQA-Constantan	-270 to -220°C	1.0°C
		-220 to 1000°C	0.4°C
		-454 to -364°F	1.8°F
		-364 to 1832°F	0.7°F
<b>R</b>	Pt/13%Rh-Pt	-50 to 40°C	1.0°C
		40 to 1788°C	0.5°C
		-58 to 104°F	1.8°F
		104 to 3250°F	0.9°F
<b>S</b>	Pt/10%Rh-Pt	-50 to 100°C	1.0°C
		100 to 1768°C	0.5°C
		-58 to 212°F	1.8°F
		212 to 3214°F	0.9°F
<b>B</b>	30%Rh-Pt/6%Rh-Pt	200 to 640°C	1.0°C
		640 to 1820°C	0.5°C
		212 to 1184°F	1.8°F
		1184 to 3308°F	0.9°F
<b>C</b>	5%Re-W/26%Re-W	0 to 2354°C	0.4°C
		32 to 4253°F	0.7°F
<b>N</b>	Nicrosil-Nisil	-250 to -100°C	1.0°C
		-100 to 1300°C	0.4°C
		-418 to -148°F	1.8°F
		-148 to 2372°F	0.7°F
<b>L</b>	J DIN	-200 to 900°C	0.4°C
		-328 to 1652°F	0.7°F
<b>RTD</b>	Pt, 0.00385, 100 Ω, 500 Ω, 1000 Ω	200 to 900°C	0.4°C
		-328 to 1652°F	0.7°F
<b>RTD</b>	Pt, 0.00392, 100 Ω, 500 Ω, 1000 Ω	-200 to 850°C	0.4°C
		-328 to 1562°F	0.7°F
<b>PROCESS</b>	Voltage	0 to 100 mV, 0 to 1 V, 0 to 10 Vdc	0.03% rdg
<b>PROCESS</b>	Current	0 to 20 mA, 4 to 20 mA	0.03% rdg

**PART 5**  
**FACTORY PRESET VALUES**

Table 5.1 Factory Preset Values

MENU ITEMS	FACTORY PRESET VALUES	NOTES
Set Point 1 (SP1)	000.0	
Set Point 2 (SP2)	000.0	
<b>Input:</b>		
Input Type (INPT)	TC, type K	
<b>Reading Configuration (RDG):</b>		
Decimal Point (DEC.P)	FFF.F	
Temperature unit (TEMP)	°F	
Filter value (FLTR)	0004	
<b>Alarm 1:</b>		
Alarm 1 (ALR1)	Enable (ENBL)	
Absolute/Deviation (ABSO/DEV)	Absolute (ABSO)	
Latch/Unlatch (LTCH/UNLT)	Unlatch (UNLT)	
Active (ACTV)	Below (BELO)	
Alarm 1 At Power On (A.P.ON)	Enable (ENBL)	Alarm 1 only
Alarm 1 Low (ALR.L)	32.00	
Alarm 1 High (ALR.H)	000.0	
<b>Alarm 2:</b>		
Alarm 2 (ALR2)	Disable (DSBL)	
Absolute/Deviation (ABSO/DEV)	Absolute (ABSO)	
Latch/Unlatch (LTCH/UNLT)	Unlatch (UNLT)	
Active (ACTV)	Above (ABOV)	
Alarm 2 Low (ALR.L)	000.0	
Alarm 2 High (ALR.H)	212.0	
Reading Adjust Value (R.ADJ)	000.0	
Setpoint Deviation (SP.dV)	Disabled	
<b>ID:</b>		
ID Value	0000	
Full ID (FULL)	Disable (DSBL)	
Set Point ID (ID.SP)	Disable (DSBL)	
<b>Communication Parameters: (not available)</b>		
<b>Display Color (COLR):</b>		
Normal Color (N.CLR)	Green (GRN)	
Alarm 1 Color (1.CLR)	Amber (AMBR)	
Alarm 2 Color (2.CLR)	Red (RED)	

## **PART 6 CE APPROVALS INFORMATION**



This product conforms to the EMC directive 89/336/EEC amended by 93/68/EEC, and with the European Low Voltage Directive 72/23/EEC.

### **Electrical Safety EN61010-1:2001**

Safety requirements for electrical equipment for measurement, control and laboratory.

#### **Double Insulation**

#### **Pollution Degree 2**

#### **Dielectric withstand Test per 1 min**

- Power to Input/Output: 2300Vac (3250Vdc)
- Power to Input/Output: 1500Vac (2120Vdc)  
(Low Voltage dc Power Option\*)
- Power to Relays Output: 2300Vac (3250Vdc)

### **Measurement Category I**

Category I are measurements performed on circuits not directly connected to the Mains Supply (power). Maximum Line-to-Neutral working voltage is 50Vac/dc. This unit should not be used in Measurement Categories II, III, IV.

### **Transients Overvoltage Surge (1.2 / 50uS pulse)**

- Input Power: 2500V
- Input Power: 1500V  
(Low Voltage dc Power Option\*)
- Ethernet: 1500V
- Input/Output Signals: 500V

Note: \*Units configured for external low power dc voltage, 12 to 36Vdc

### **EMC EN61326:1997 + and A1:1998 + A2:2001**

Immunity and Emissions requirements for electrical equipment for measurement, control and laboratory.

- EMC Emissions Table 4, Class B of EN61326
- EMC Immunity\*\* Table 1 of EN61326

**Note:** \*\*I/O signal and control lines require shielded cables and these cables must be located on conductive cable trays or in conduits. Furthermore, the length of these cables should not exceed 30 meters.



Refer to the EMC and Safety installation considerations (Guidelines) of this manual for additional information.





## WARRANTY/DISCLAIMER

OMEGA ENGINEERING, INC. warrants this unit to be free of defects in materials and workmanship for a period of **one (1) year** from the date of purchase. In addition to OMEGA's standard warranty period, OMEGA Engineering will extend the warranty period for **four (4) additional years** if the warranty card enclosed with each instrument is returned to OMEGA.

If the unit malfunctions, it must be returned to the factory for evaluation. OMEGA's Customer Service Department will issue an Authorized Return (AR) number immediately upon phone or written request. Upon examination by OMEGA, if the unit is found to be defective, it will be repaired or replaced at no charge. OMEGA's WARRANTY does not apply to defects resulting from any action of the purchaser, including but not limited to mishandling, improper interfacing, operation outside of design limits, improper repair, or unauthorized modification. This WARRANTY is VOID if the unit shows evidence of having been tampered with or shows evidence of having been damaged as a result of excessive corrosion; or current, heat, moisture or vibration; improper specification; misapplication; misuse or other operating conditions outside of OMEGA's control. Components which wear are not warranted, including but not limited to contact points, fuses, and triacs.

OMEGA is pleased to offer suggestions on the use of its various products. However, OMEGA neither assumes responsibility for any omissions or errors nor assumes liability for any damages that result from the use of its products in accordance with information provided by OMEGA, either verbal or written. OMEGA warrants only that the parts manufactured by it will be as specified and free of defects. OMEGA MAKES NO OTHER WARRANTIES OR REPRESENTATIONS OF ANY KIND WHATSOEVER, EXPRESS OR IMPLIED, EXCEPT THAT OF TITLE, AND ALL IMPLIED WARRANTIES INCLUDING ANY WARRANTY OF MERCHANTABILITY AND FITNESS FOR A PARTICULAR PURPOSE ARE HEREBY DISCLAIMED. LIMITATION OF LIABILITY: The remedies of purchaser set forth herein are exclusive, and the total liability of OMEGA with respect to this order, whether based on contract, warranty, negligence, indemnification, strict liability or otherwise, shall not exceed the purchase price of the component upon which liability is based. In no event shall OMEGA be liable for consequential, incidental or special damages.

CONDITIONS: Equipment sold by OMEGA is not intended to be used, nor shall it be used: (1) as a "Basic Component" under 10 CFR 21 (NRC), used in or with any nuclear installation or activity; or (2) in medical applications or used on humans. Should any Product(s) be used in or with any nuclear installation or activity, medical application, used on humans, or misused in any way, OMEGA assumes no responsibility as set forth in our basic WARRANTY/DISCLAIMER language, and, additionally, purchaser will indemnify OMEGA and hold OMEGA harmless from any liability or damage whatsoever arising out of the use of the Product(s) in such a manner.

## RETURN REQUESTS/INQUIRIES

Direct all warranty and repair requests/inquiries to the OMEGA Customer Service Department. BEFORE RETURNING ANY PRODUCT(S) TO OMEGA, PURCHASER MUST OBTAIN AN AUTHORIZED RETURN (AR) NUMBER FROM OMEGA'S CUSTOMER SERVICE DEPARTMENT (IN ORDER TO AVOID PROCESSING DELAYS). The assigned AR number should then be marked on the outside of the return package and on any correspondence.

The purchaser is responsible for shipping charges, freight, insurance and proper packaging to prevent breakage in transit.

FOR **WARRANTY** RETURNS, please have the following information available BEFORE contacting OMEGA:

1. Purchase Order number under which the product was PURCHASED,
2. Model and serial number of the product under warranty, and
3. Repair instructions and/or specific problems relative to the product.

FOR **NON-WARRANTY** REPAIRS, consult OMEGA for current repair charges. Have the following information available BEFORE contacting OMEGA:

1. Purchase Order number to cover the COST of the repair,
2. Model and serial number of product, and
3. Repair instructions and/or specific problems relative to the product.

OMEGA's policy is to make running changes, not model changes, whenever an improvement is possible. This affords our customers the latest in technology and engineering.

© Copyright 2013 OMEGA ENGINEERING, INC. All rights reserved. This document may not be copied, photocopied, reproduced, translated, or reduced to any electronic medium or machine-readable form, in whole or in part, without the prior written consent of OMEGA ENGINEERING, INC.

TRADEMARK NOTICE:  **omega.com**<sup>®</sup>, **ΩOMEGA**<sup>®</sup>, and  are Trademarks of OMEGA ENGINEERING, INC.

PATENT NOTICE: This product is covered by one or more of the following patents: U.S. Pat. No. Des. 336,895; 5,274,577; 6,243,021 / CANADA 2052599; 2052600 / ITALY 1249456; 1250938 / FRANCE BREVET No. 91 12756 / SPAIN 2039150; 2048066 / UK PATENT No. GB2 249 837; GB2 248 954 / GERMANY DE 41 34398 C2. The "Meter Bezel Design" is a Trademark of NEWPORT Electronics, Inc. Used under License. Other US and International Patents pending or applied for.

# Where Do I Find Everything I Need for Process Measurement and Control? **OMEGA...Of Course!** *Shop on line at [omega.com](http://omega.com)*

## **TEMPERATURE**

- Thermocouple, RTD & Thermistor Probes, Connectors, Panels & Assemblies
- Wire: Thermocouple, RTD & Thermistor
- Calibrators & Ice Point References
- Recorders, Controllers & Process Monitors
- Infrared Pyrometers

## **PRESSURE, STRAIN AND FORCE**

- Transducers & Strain Gauges
- Load Cells & Pressure Gauges
- Displacement Transducers
- Instrumentation & Accessories

## **FLOW/LEVEL**

- Rotameters, Gas Mass Flowmeters & Flow Computers
- Air Velocity Indicators
- Turbine/Paddlewheel Systems
- Totalizers & Batch Controllers

## **pH/CONDUCTIVITY**

- pH Electrodes, Testers & Accessories
- Benchtop/Laboratory Meters
- Controllers, Calibrators, Simulators & Pumps
- Industrial pH & Conductivity Equipment

## **DATA ACQUISITION**

- Data Acquisition & Engineering Software
- Communications-Based Acquisition Systems
- Plug-in Cards for Apple, IBM & Compatibles
- Datalogging Systems
- Recorders, Printers & Plotters

## **HEATERS**

- Heating Cable
- Cartridge & Strip Heaters
- Immersion & Band Heaters
- Flexible Heaters
- Laboratory Heaters

## **ENVIRONMENTAL MONITORING AND CONTROL**

- Metering & Control Instrumentation
- Refractometers
- Pumps & Tubing
- Air, Soil & Water Monitors
- Industrial Water & Wastewater Treatment
- pH, Conductivity & Dissolved Oxygen Instruments