

1 YEAR
WARRANTY



Ω OMEGA™ User's Guide



*Shop online at
omega.com*

*e-mail: info@omega.com
For latest product manuals:
www.omegamanual.info*

CN78000
1/16 DIN Temperature/Process
Controllers with Fuzzy Logic



**U.S.A.
Headquarters:**

Servicing North America:

Omega Engineering, Inc.
Toll-Free: 1-800-826-6342 (USA & Canada only)
Customer Service: 1-800-622-2378 (USA & Canada only)
Engineering Service: 1-800-872-9436 (USA & Canada only)
Tel: (203) 359-1660 Fax: (203) 359-7700
e-mail: info@omega.com

For Other Locations Visit omega.com/worldwide

CONTENTS

GETTING STARTED	2
MODEL IDENTIFICATION	3
INSTALLATION	4
WIRING	5
Wiring for 4 to 20mA Transmitter Inputs	6
Wiring for Optional Inputs and Outputs	6
FRONT PANEL KEY FUNCTIONS	8
Security Level Selection	9
NOTATION CONVENTIONS FOR THE MENUS	10
THE HOME DISPLAY	11
Program Setup and Operation	12
OPERATION AND PROGRAMMING OF OPTIONS	12
MENU SELECTIONS	15
PRIMARY MENU	15
SECONDARY MENU	15
SECURE MENU	22
ALARM TYPE AND ACTION	27
ERROR MESSAGES	31-33
SPECIFICATIONS	34
DIMENSIONS	Front Cover

GETTING STARTED

1. Install the control as described on page 4.
2. Wire your control following the instructions on page 5. If you are using a two-wire transmitter as an input, see the drawing and instructions on page 6. Option wiring instructions are on Page 7. Option descriptions and specific instructions start on page 13.
3. Most controls do not need many (if any) program changes to work on your process. For best results when changing the programming, make all the necessary changes in the Secure Menu (page 22) before making changes to the Secondary Menu (page 16). If error messages occur, check the Error Messages on page 31-33 for help.

Take the example of a Series CN78000 that comes from the factory programmed for type J thermocouples. Suppose for this example you wish to change the input to a 100 ohm Platinum RTD and limit the set point range between 0° and 300°C.

First enter the Secure menu by pressing and holding the **UP ARROW** & **ENTER** keys

for 5 Seconds (see Page 22.) Press the **INDEX** key until the display shows *inP* and press the **DOWN ARROW** until the display shows *P385*. Don't forget to press the **ENTER** key to retain your setting.

Next, press the **INDEX** key to display *Unit*. Press the **DOWN ARROW** until the display shows *ℓ*. Press **ENTER**.

Next, press the **INDEX** key until *SPL* is displayed (pass the *dPt* and *inPt* selections). Press the **UP ARROW** until the display shows *0*. Press **ENTER**.

Finally, press **INDEX** key to display *SPH*. Press the **DOWN ARROW** until the display shows *300*. Press **ENTER**.

The necessary program changes are now complete. After 30 seconds the display will switch back to the temperature reading. If you want to return faster, press the **UP ARROW** and **ENTER** keys (at the same time) and then press the **DOWN ARROW** and **INDEX** keys (again at the same time). This will 'back out' of the menu and immediately display the temperature reading.

If you want to use Self Tune or Auto/Manual features, see the special sections on these items. Page numbers for these are in the Contents section on the previous page.

CN78

Alarm 0 = No 1 = Yes	Output A 1 = SSR 2 = 15 VDC 3 = Relay 5 = Current	Output B 0 = None 1 = SSR 3 = Relay	Options Pv1 = 0-20 mA Pv2 = 0-10 VDC C4 = RS485 C2 = RS232 LV = Low Voltage
-----------------------------------	--	---	---

Option Description

- PV1* Analog Retransmission of Process Variable or Set Variable, 0 to 20 mAdc, scalable (may be programmed for 1 to 5mA, 4 to 20 mA, etc).
- PV2* Analog Retransmission of Process Variable or Set Variable, 0 to 10 Vdc, scalable.
- C4* RS-485 Serial Communications, Lovelink™ protocol.
- C2* RS-232 Serial Communications, Lovelink™ protocol.
- LV* 12-24 Vdc/Vac 50-400 Hz power supply (control operates on low voltage equipment).

* These options may not be combined with each other.
 Option LV may be combined with other options.

INSTALLATION

Mount the instrument in a location that will not be subject to excessive temperature, shock, or vibration. All models are designed for mounting in an enclosed panel.

Select the position desired for the instrument on the panel. If more than one instrument is required, maintain the minimum of spacing requirements as shown on the drawing below. Closer spacing will structurally weaken the panel, and invalidate the IP66, UL type 4X rating of the panel.

Prepare the panel by cutting and deburring the required opening.

All Tolerances are $-0.00 +0.60\text{mm}$ ($-0.000 + 0.020$ in.)

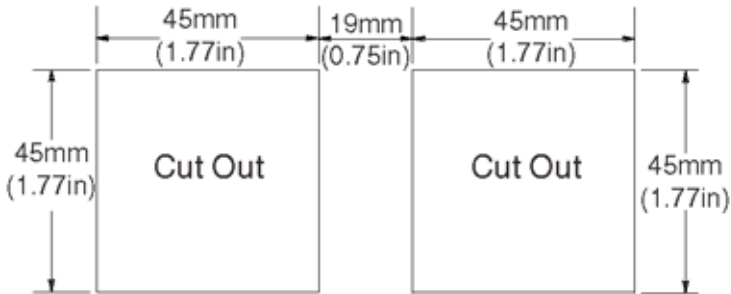

From the front of the panel, slide the housing through the cut out. The housing gasket should be against the housing flange before installing.

From the rear of the panel slide the mounting collar over the housing. Hold the housing with one hand and using the other hand, push the collar evenly against the panel until the spring loops are slightly compressed. The ratchets will hold the mounting collar and housing in place.

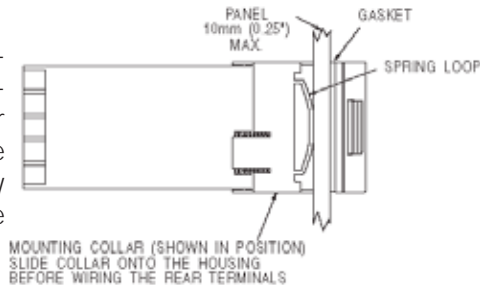

CAUTION: It is not necessary to remove the instrument chassis from the housing for installation. If the instrument chassis is removed from the housing, you must follow industry standard practice for control and protection against Electro-Static Discharge (ESD). Failure to exercise good ESD practices may cause damage to the instrument.

WIRING



Do not run RTD, thermocouple, or other class 2 wiring in the same conduit as power leads. Use only the type of thermocouple or RTD probe for which the control has been programmed. Maintain separation between wiring of sensor, optional inputs and outputs and other wiring. See the "Secure Menu" for input selection.

For thermocouple inputs always use extension leads of the same type designated for your thermocouple.

For supply connections use No. 16 AWG or larger wires rated for at least 75°C. Use copper conductors only. All line voltage output circuits must have a common disconnect and be connected to the same pole of the connect.

Input wiring for thermocouple, current, and RTD; and output wiring for current and 15 VDC is rated CLASS 2.

Control wiring is as shown (view is from the rear of instrument showing wiring terminals).

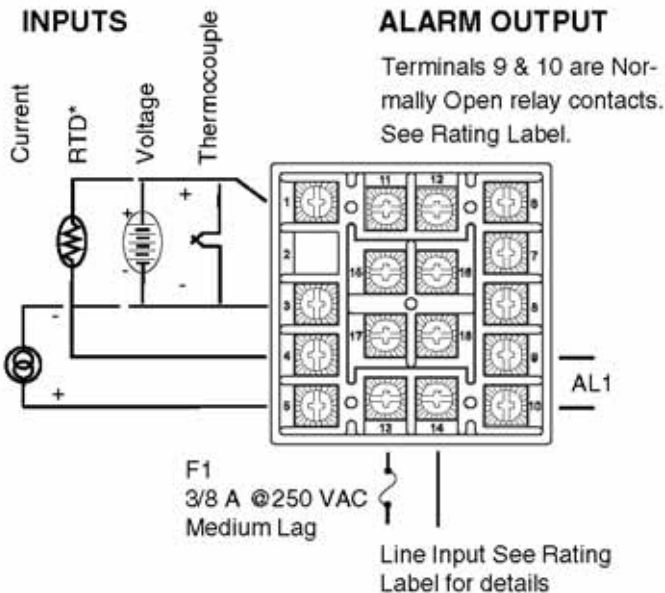

- * For 2-wire 1000 Ω RTD use terminals 1 & 3.
For 2-wire 100 Ω RTD use terminals 1 & 3, and place a jumper wire between terminals 3 & 4.

OUTPUTS

(Rear View showing center)

Output A

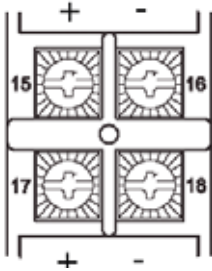

For AC SSR or relay type outputs (Output Codes 1 or 3), 15 & 16, and 17 & 18 are normally open. See Rating Label for details.

Output B

For Pulsed DC, Current, or DC SSR outputs (Output codes 2, 4, or 8), 15 & 17 are positive, 16 & 18 are negative.

Note: Factory default assigns Output A to Set Point 1 and Output B to Set Point 2. If necessary, these relationships may be reversed. See **SP 10** in the Secure Menu.

Wiring for 4 to 20mA Transmitter Inputs

Wiring power and outputs as shown above. Two-wire transmitters wire as shown below. View is of instrument as seen from the rear to show wiring terminals. For three or four-wire transmitters, follow the wiring instructions provided with your transmitter.



CAUTION: DO NOT WIRE THE 24 VOLT POWER SUPPLY ACROSS THE INPUT OF THE CONTROL. DAMAGE TO THE CONTROL INPUT CIRCUITRY WILL OCCUR.

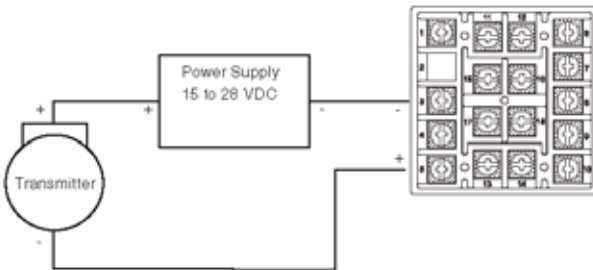

Wiring for Optional Inputs and Outputs

Options are described on Page 3. Detailed option programming and operation starts on Page 13. Wire power and outputs as shown on Pages 5 and 6. Wiring for options is shown opposite. All wiring shown above is CLASS 2. Shielded twist-pair is required for Option C4. Shielded cable is required for Option C2.



CAUTION: DO NOT RUN SIGNAL WIRING IN THE SAME CONDUIT OR CHASE AS THE POWER WIRING. ERRATIC OPERATION OR DAMAGE TO THE CONTROL CIRCUITRY WILL OCCUR.

OPTION/TERMINALS	11	12	6	7	8
PV1 PV/SV Retransmission, Current (e.g. 4-20 mA)	+	-	na	na	na
PV2 PV/SV Retransmission, Voltage (e.g. 0-10V)	+	-	na	na	na
C4 RS-485 Serial Communications	B	A	na	na	na
C2 RS-232 Serial Communications	Data In	Data Out	Signal Ground	na	na

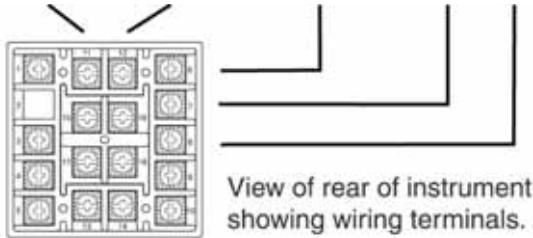

RS-485 Daisy Chain Wiring Example



Note: Industry standard designation for RS-485 lines is A and B. Some equipment manufacturers use a non-standard designation of plus and minus. The association of A to minus and B to plus is based on a sample of devices marked as plus and minus and is not intended to represent ALL such labelled devices. Final responsibility for correct identification of leads and terminals rests with the user/installer and the manufacturer of the other device(s) installed in the system.

RS-232 DB-25 WIRING (VIEWED FROM WIRE SIDE)

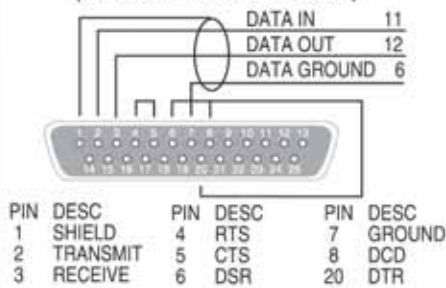

RS-232 DB-9 WIRING (VIEWED FROM WIRE SIDE)

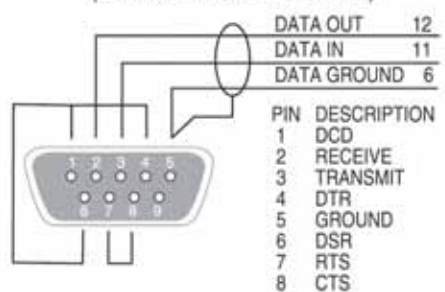











FRONT PANEL KEY FUNCTIONS



The decimal point flashes when Self Tune is operating.

Keys are illuminated when pressed. Key functions are as follows:

-  **INDEX:** Menu Navigation. Pressing the  INDEX key advances the display to the next menu item. May also be used in conjunction with other keys as noted below.
-  **UP ARROW:** Increments a value, changes a menu item, or selects the item to ON. The maximum value obtainable is 9999 regardless of decimal point placement.
-  **DOWN ARROW:** Decrements a value, changes a menu item, or selects the item to OFF. The minimum value obtainable is -1999 regardless of decimal point placement.
-  **ENTER:** Pressing  ENTER stores the value or the item changed. If not pressed, the previously stored value or item will be retained. The display will flash once when  ENTER is pressed.
-  **UP ARROW & ENTER:** Menu Access. Pressing these keys simultaneously brings up the secondary menu starting at the alarm, tune, or cycle item (depending on programming). Pressing these keys for 5 seconds will bring up the secure menu.
-  **INDEX & DOWN ARROW:** Menu navigation. Pressing these keys simultaneously will allow backing up one menu item, or if at the first menu item they will cause the display to return to the primary menu.
-  **INDEX & DOWN ARROW:** Alarm Reset. If an alarm condition has occurred, press and hold these keys for three seconds to reset the alarm. Note that the alarm condition will not reset if the alarm condition still exists.
-  **INDEX & ENTER:** 'Global Reset'. Pressing these keys simultaneously and holding them for 5 seconds forces a 'warm boot', restarting the

control (similar to turning power off and on). 'Global Reset' will allow recovery from errors and reset the following menu items:

AL H: Alarm inhibit

OPEN InP: Input error



BR nP: Input err

CHEC CAL: Check calibration



Correct the problems associated with the above conditions before using the reset keys. More than one error could present. Caution is advised since several items are reset at one time.



While in the **Primary** or **Secondary Menu**, if no key is pressed for a period of 30 seconds, the display will return to the HOME position displaying the temperature value. While in the **Secure Menu**, if no key is pressed for a period of 60 seconds, the display will return to HOME position displaying the temperature value. Outputs are disabled (turned off) when the **Secure Menu** is active.

NOTE: To move the **Primary Menu** quickly from any other menu, press the

  **UP ARROW & ENTER** keys followed by pressing the  **INDEX & DOWN ARROW** keys.

SECURITY LEVEL SELECTION

Four levels of security are provided. The display shows the current security level. To change security levels, change the password value using the  **UP ARROW** and  **DOWN ARROW** keys and press the  **ENTER** key. Refer to the password table for the correct value to enter for the security level desired. The **SEC** menu item security level may be viewed or changed at any time regardless of the present security level.

Example: To set security access level to 2, at the **SEC** menu item, press the  **UP ARROW** key until the upper display shows the password for level 2 access, **1101**. Press the  **ENTER** key. The display will blink and return with the level value, **2**, in the upper display.

The password values shown in the table cannot be altered, so retain a copy of these pages for reference. This is the only reference made to password values in this instruction book.

PASSWORD TABLE

Security Level Menu	Level Status	Displaying Value When Viewed	Password Value To Enter
Primary	Locked	1	1110
Secondary	Locked		
Secure	Locked		
Primary	Unlocked	2	1101
Secondary	Locked		
Secure	Locked		
Primary	Unlocked	3	1011
Secondary	Unlocked		
Secure	Locked		
Primary	Unlocked	4	111
Secondary	Unlocked		
Secure	Unlocked		

NOTATION CONVENTIONS FOR THE MENUS

Because of the number of features available in this control, information is included that may not apply to your specific control. All usable features are included in this book, but may not be used in your process. To increase clarity, the following conventions are used:

1. Certain features, menu items, and functions shown in this book may or may not appear on your control, depending on other menu item selections. At various places in the menu there are notes identifying menu items that "control" or "direct" other menu items. If you are looking for a particular menu item and can't find it, check the menu item that is its "control" for proper setting



2. The "#" symbol is used in two ways. It is used inside group of characters to indicate which set point function (SP1 or SP2) is being affected. It is also used before a group of characters of a menu item to indicate that there may be more than one selection or value for that menu item. This is used for certain repeated items such as in the Ramp/Soak Program section.

3. *Features that apply only to Options will be printed in Italics.*

THE HOME DISPLAY

The home display is the normal display while the control is operating. If no errors or functions are active, the HOME display will indicate the Process Variable (the temperature, pressure, flow, RH, etc., that is being measured) on the top display and the Set Variable (Set Point 1) on the bottom.

Items that can change the HOME display are the Auto/Manual function, the Run/Hold function, the *Prog* function, the *PctO* function, and any error message. Description of these special displays follows.

If the  Auto/Manual key is pressed, the Manual indicator lights, and the home display is changed. The upper display continues to show the Process Variable (PV), but the lower display changes to show the percentage of output in tenths of a percent to 99.9% (0.0 to 99.9) or 100 if 100%. The display digit to the right of the number shows a flashing letter *o* to indicate that the value displayed is no longer the SV, but percent output. The *SP2* percent output is indicated by the use of an overline on the *o*. Access to the *SP2* value is made by the  INDEX key. See Auto/ Manual Operation on Page 14 for further information.

If *Prog* is turned *On*, the HOME display changes the SV display from SP1 to the Present Set Variable as calculated by the Ramp/Soak Programmer function. See Programming and Operation for Ramp/Soak Feature below for more information.

If *PctO* (Secondary Menu) is turned *On*, the lower display changes to show the active percentage of output as required to maintain *SP1*. The display is similar to the Auto/Manual display above, except that the percent indicators (*o*, *o*) do not flash, and the output is displayed in whole percentages of output, not in tenths of a percent. If the control has both *SP1* and *SP2*, the lower display will alternate between the *SP1* percent output and the *SP2* percent output.

Error messages are listed on Pages 37-39.

OPERATION AND PROGRAMMING OF OPTIONS

Option PV1, PV2, Isolated Analog Retransmission

The analog retransmission option allows the process variable or the Set Variable to be sent as an analog signal to an external device. The signal may be either 0 to 10 VDC (Option PV2) or 0 (or 4) to 20 mA DC (option PV1). The output may be changed in the field from one to the other by the toggle switch located on the top printed circuit board.

Wire the output as shown on page 7.

To set up the analog retransmission, first determine the scale range that the analog signal will represent. The maximum scale is 9999°F, 5530°C, or 9999 counts. In the Secondary Menu set **PQL** for the scale value that will be represented by the high end of the analog signal (10 Volts or 20 mA).

If you require a suppressed scale or output, use the following equations to determine the proper setting for **PQH** and **PQL**.

K = (Highest desired scale reading - Lowest desired scale reading) /
(Maximum desired analog signal - Minimum desired analog signal).

PQH = ((Maximum possible analog output - Maximum desired analog signal) * K) /
+ Highest desired analog reading.

PQL = Lowest desired scale reading - ((Minimum desired analog output) * K).

Next select whether you want the retransmission signal to follow the Process Variable or the Set Variable. Usually the Process Variable is sent to recorders or other data acquisition devices. Usually the Set Variable is sent to other controls to be used as an analog remote set point. If you want the analog retransmission signal to follow the PV, in the Secondary Menu set **PQSR** to **INP**. If you want the analog retransmission signal to follow the SV, set **PQSR** to **SPE**.

Operation is automatic. There are no further programming steps required.

Option C2, C4, Serial Communication

The serial communications options allow the control to be written to and read from a remote computer or other similar digital device. Communication is allowed either through a RS-485 (Option C4) port, or a RS-232 (Option C2) port.

Wire the communication lines as shown on Page 7. Wiring for the RS-485 is run from control to control in a daisy chain fashion with a termination resistor (120 ohms) across the transmit and receive terminals of the last control in the chain.

Select the control address and communication baud rate with the **Addr** and **BAUD** menu items in the Secure Menu.

NOTE: THE BAUD RATE AND ADDRESS MENU ITEM SETTINGS WILL TAKE EFFECT ON THE NEXT POWER UP OF THE CONTROL. BE SURE TO TURN THE POWER TO THE CONTROL OFF AND ON BEFORE USING THE NEW BAUD RATE AND ADDRESS VALUES.

In operation, you have the option of preventing a write command from the host computer. To prevent the host from writing to the control change the **LDRE** menu item in the Secondary Menu to **LOC**. To allow the host to write commands to the control set **LDRE** to **RE**. (The host does have the ability to change the **LDRE** state, but it is not automatic.)

If your system depends on constant reading or writing to and from the host, you may wish to set the No Activity Timer (**NAT**) to monitor the addressing of the control. When the **LDRE** is set to **RE** and the **NAT** is set to any value other than Off, the control will expect to be addressed on a regular basis. If the control is not addressed in the time set by the value of **NAT**, then the control will display the error message **CHECK LDRE**. To clear the message set **LDRE** to **LOC**.

Serial Communications Options and Non-volatile Memory

There are many different types of memory used in computer driven devices. The terms RAM (random access memory) and ROM (read only memory) are a couple with which you may be familiar.

RAM is used in computers to run programs and hold data for a short period of time. This is the memory that is used primarily in PCs. RAM is very fast and can be read and written to over and over again.

ROM is used in computers to hold the 'permanent' programming that allows a PC to start. This memory is 'burned in' to the chip itself and can not be changed. Unlike RAM, however, this memory is permanent. While it can not be changed, it can not lose its programming when power is turned off.

There is a third type of memory that is now currently used to combine the characteristics of both RAM and ROM. This is known as EEPROM (electrically erasable programmable read only memory). While the name may be long and somewhat cryptic, the EEPROM can be erased and re-written many times, and yet hold the programmed data even over long periods of time when the power is off. This is the type of memory that all Omega products use to save the settings your program in your control. The reliability and longevity of the data retention is what allows us to guarantee a 10 year data retention without power.

In normal operation, the control uses RAM, just as any other computerized device. Whenever you make a change to one of the parameters in the control, the set point for example, the new value is written into the EEPROM. This way, if power goes off for whatever reason, when power resumes, the latest settings are preserved. When

power is turned on, the data is copied from the EEPROM to the RAM to begin operation.

If EEPROM is such a wonderful thing, you might ask, why bother with RAM? One reason is that RAM is much faster than EEPROM. Faster speed gives you better performance in critical control functions.

Perhaps the most important reason is that EEPROM has a limit to the number of times it can be erased and re-written. Current technology now sets that limit at about one million erase/write cycles. In a dynamic control situation, it may be necessary to update RAM every few milliseconds. EEPROM can not keep up to that pace, and, even if it could, it would be 'used up' in a matter of days.

If you think about how long it would take a million changes to the control programming through the front key pad, you will see that it would take a very long time to get to use up the life of the EEPROM.

Adding one of the computer communications options (e.g. 992, 993) changes the picture. The speed of computer communications is such that hundreds of instructions can be made in less than a minute. In such a situation, the million erase/write cycles could be used up in a couple of months causing the control to fail.

Usually in such a situation, the control is under close observation by the host computer. It may not be necessary, then to the data written to the EEPROM, as it is 'transitory' in nature (changing set points for a ramp/soak sequence for example).

All CN78000 Series controls with communications options made before April 2001 are only able to write to the EEPROM. Controls manufactured after this date have a menu item in the Secure menu (*Stor*) that allows the serial communications to write to RAM (*Stor = ra*) with a special write command that allows to EEPROM to be updated or written directly to EEPROM (protocol command 0442).

The factory default is 'write to EEPROM' (*Stor = YES*).

If your computer system will be making frequent changes to the control we strongly recommend that you select the 'write to RAM' parameters (*Stor = ra*). If you are primarily reading from the control, there is no need to change the setting.



Any instruments equipped with any Serial Communications are limited to one million WRITE cycles to the EEPROM through the Serial Communications Port. Exceeding this limit will generate a *FAIL TEST* error. There is no limit to the number of times you can READ from this instrument EEPROM.

Make sure that the software you use does not write too often to the instrument.

If you have any questions regarding how your software works with the instrument(s), contact your System Administrator, Programmer, or Software Supplier.

MENU SELECTIONS

PRIMARY MENU

Press **INDEX** to advance to the next menu item. Press **UP ARROW** or **DOWN ARROW** to change the value in the display. Press **ENTER** to retain the value. If StAt, (Secondary Menu [16A3]), is **On**, the three program status menu items shown on Page 14 will precede the following.

SP 1 Set Point 1 Adjust, Control Point 1.

SP 2 Set Point 2 Adjust (if equipped), Control Point 2.

SECONDARY MENU

Hold **UP ARROW & ENTER**. Press **INDEX** to advance to the next menu item. Press **UP ARROW** or **DOWN ARROW** to change the value in the display. Press **ENTER** to retain the value.

AL 1 Lo Alarm 1 Low: The Low Alarm point is usually set below the Set Point. May not appear depending on **AL 1** setting in Secure Menu.

AL 1 Hi Alarm 1 High: The High Alarm Point is usually set above the Set Point. May not appear depending on **AL 1** setting in Secure Menu.

Out 1 Output selection: Select **OnOff**, **#tP**, **#PUL**, or **Prop**.

OnOff A setting of **OnOff** allows the control to operate in simple on/off mode. This setting forces the control to turn off at set point, and on at the set point plus the differential (**SP Id**). When selected, the **Out 1 OnOff** menu items is followed by **#### SP Id**, and the **turnE**, **Pb**, **rES**, **S IDL** and **S IOH** selections in the Secure menu are suppressed.

SP Id Set Point On-Off Differential (hysteresis). Set for the amount of difference between the turn off point and the turn on point. Select **1** to **9999** (direct acting), or **-1** to **-9999** (reverse acting). This value will be negative for reverse acting set points, and positive for direct acting outputs. The following drawings shows output behavior for reverse and direct action. For reverse action note how the output decreases as the input process variable increases, e.g. heat power goes to zero as the temperature increases to set point.

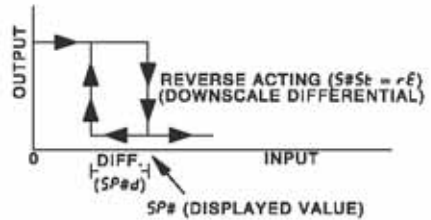
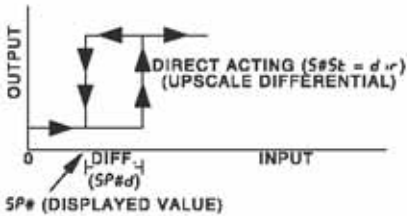

##tP Time Proportioning Cycle Time. Select **1tP** to **80tP**.

1tP A setting of 1tP is recommended for solid state outputs (SSR or 15VDC).

2tP to **80tP** Time Proportioning Control is adjustable in 1 second steps. Recommended for mechanical outputs (relays, solenoids, etc.). For best contact life, a time should be selected as long as possible without causing the process to wander.

#PUL Pulsed Time Proportioning Output: Select **1PUL** to **7PUL**. **1PUL** = Linear and **7PUL** = most nonlinear. Changes output linearity for use in cooling applications or for extremely fast response processes. At the center of the proportional band, a pulse value of 1 provides an output of one second on and one second off (50% output). A pulse value of 2 provides an output of one second on and two seconds off (33% output). Output at center of band equals one second on, $2^{(\text{pulse value}-1)}$ seconds off.

Prop For Current (Code 5) outputs only.

The following menu items apply only if your control is equipped with a second set point (last digit of model number is not zero). If your control does not have a second set point, jump to the **ευνε** menu on the next page.

- Out2** Output selection: Select OnOF, **#tP**, **#PUL**, or **PrOP**.
- OnOF** A setting of **OnOF** allows the control to operate in simple on/off mode. This setting forces the control to turn off at set point, and on at the set point plus the differential (**SP2d**). When selected, the **Out2/OnOF** menu item is followed by #### **SP2d**, and the **Pb2** selection in the Secondary menu and the **520L** and **520H** selections in the Secure menu are suppressed.
- SP2d** Set Point On-Off Differential (hysteresis). Select **!** to **9999** (direct acting), or **-!** to **-9999** (reverse acting). See **SP 1d** on the previous page.
- ##tP** Time Proportioning Cycle Time. Select **tP** to **80tP**.
- tP** A setting of **tP** is recommended for solid state outputs (SSR or 15VDC).
- 2tP** to **80tP** Time Proportioning Control is adjustable in 1 second steps. Recommended for mechanical outputs (relays, solenoids, etc.). For best contact, life, a time should be selected as long as possible without causing the process to wander.
- #PUL** Pulsed Time Porportioning Output: Select **!PUL** to **7PUL**.
!PUL = Linear and **7PUL** = most nonlinear. Changes output linearity for use in cooling applications or for extremely fast response processes. At the center of the proportional band, a pulse value of 1 provides an output of one second on and one second off (50% output). A pulse value of 2 provides an output of one second on and two seconds off (33% output). Output at center of band equals one second on, 2(pulse value -1) seconds off.
- PrOP** For Current (Code 5) outputs only.

- tune** Tuning Choice: Select **SELF**, **P id**, **SLO**, **nor**, or **FAST**.
- SELF** The Controller will evaluate the Process and select the PID values to maintain good control. Active for SP1 only.
- LErn** Select **YES** or **no**
- YES** Start Learning the Process. After the process has been learned the menu item will revert to **no**.
- no** Learning will stay in present mode.
- dFAC** Damping factor, select **OFF**, **1** to **7**. Sets the ratio of Rate to Rate for the **SELTune** mode. **7** = most Rate. Factory set to **3**. For a fast response process the value should be lowered (less Rate). For a slower process the value should be increased (more Rate).
- P id** Manually adjust the PID values. PID control consists of three basic parameters, Proportional Band (Gain), Reset Time (Integral), and Rate Time (Derivative).
- Pb 1** Proportional Band (Bandwidth). Select **1** to **9999**°F, °C, or counts.
- Pb2** Proportional Band (Bandwidth). Select **1** to **9999**°F, °C, or counts. Appears only if control is equipped with second set point and **Out2** is NOT selected as **OnOFF**.

- rES** Automatic Reset Time. Select **OFF**, **0.1** to **99.9** minutes. Select **OFF** to switch to **OFFS**.
- OFFS** Manual Offset correction Select. Select **OFF**, **0.1** to **99.9** percent. Select **OFF** to switch to **rES**.
- rTE** Rate Time. Select **OFF**, **0.1** to **99.9** minutes. Derivative.
- SLO** PID values are preset for a slow response process.
- nor** PID values are preset for a normal response process.
- FAST** PID values are preset for a fast response process.
- pid2** Linkage of PID parameters between SP1 and SP2: Select **On** or **OFF**.
- On** Applies SP1 **rES**, **rTE**, **Fbnd**, and **FrtE** terms to SP2 for heat/cool applications
- OFF** SP2 functions without **rES**, **rTE**, **Fbnd**, and **FrtE**.
- ARUP** Anti- Reset Windup Feature: Select **On** or **OFF**.
- On** When **ARUP** is **On** the accumulated Reset Offset value will be cleared to 0% when the process input is not within the Proportional Band.
- OFF** When **ARUP** is **OFF**, the accumulated Reset Offset value is retained in memory when the process input is not within the Proportional Band.
- ArtE** Approach Rate Time: Select **OFF**, **0.1** to **99.99** minutes. The function defines the amount of Rate applied when the input is outside of the Proportional Band. The **ArtE** time and the **rTE** time are independent and have no effect on each other. To increase damping effect and reduce overshoot set the approach rate time for a value greater than the natural rise time of the process (natural rise time = process value time to set point).
- Fint** Fuzzy Logic Intensity: Select **0** to **100%**. **0%** is OFF (disables Fuzzy Logic). The function defines the amount of impact Fuzzy Logic will have on the output.
- Fbnd** Fuzzy Logic Error Band: Select **0** to **4000** °F, °C, or counts. Sets the band width of the Fuzzy Logic. Set **Fbnd** equal to PID proportional band (**Pb #**) for best results.

FrtE Fuzzy Logic Rate of Change: Select **0.00** to **99.99** counts/second. For best initial setting, find the counts/second change of process value near Set Point 1 with output ON 100%. Multiply this value by 3. Set **FrtE** to this calculated value.

PER The Peak feature stores the highest input the control has measured since the last reset or Power On. At Power On **PER** is reset to the present input. To manually reset the value **PER** must be in the lower display. Press the **ENTER** key to reset. **PER** will be reset and display the present input value.

VAL The Valley feature stores the lowest input the Instrument has measured since the last reset or Power On. At Power On **VAL** is reset to the present input. To manually reset the value **VAL** must be in the lower display. Press the **ENTER** key. **VAL** will be reset and display the present input value.

PctO Percent Output Feature: Select **On** or **OFF**.

On When selected **On**, the HOME lower display will indicate the output of the controller in percent. An "o" will appear in the right hand side of the lower display to indicate percent output for SP1. An "o" will appear on the right hand corner of the lower display to represent percent output for SP2, if the control is so equipped. The display will alternate between these values.

OFF Percent Output display is disabled.

inPC Input Correction: Select **-500** to **0** to **500** °F, °C, or counts. This feature allows the input value to be changed to agree with an external reference or to compensate for sensor error. **Note:** **inPC** is reset to zero when the input type is changed, or when decimal position is changed. Factory default is **0**.

FILT Digital Filter: Select **OFF**, **1** to **99**. In some cases the time constant of the sensor, or noise, could cause the display to jump enough to be unreadable. A setting of 2 is usually sufficient filtering (2 represents approximately a 1 second time constant). When the 0.1 degree resolution is selected this should be increased to 4. If this value is set too high, controllability will suffer.

LPbr Loop Break Protection: Select **OFF**, **1** to **9999** seconds. If, during operation, the output is minimum (0%) or maximum (100%), and the input moves less than 5°F (3°C) or 5 counts over the time set for **LPbr**, the **LOOP bAd** message will appear. This condition can also be routed to an Alarm Condition if alarms are present and turned On (see **ALbr** in the Secure Menu). The loop break error can be reset by pressing the **ENTER** key when at the **LPbr** menu item. The **INDEX & ENTER** keys may also be used.

LoRE (Option C2, C4, Serial Communications) Local / Remote Status: Select **LOC** or **rE**. Does not affect other instruments on daisy chain.

LOC The host computer is advised that remote write commands will be rejected. Any write commands sent to this control will be rejected. All read commands are accepted.

rE The host computer is allowed to send write commands. If the control is not addressed within the time set in **nAt** (No Activity Timer in the Secure Menu) the **CHEC LoRE** error message will be displayed.

Addr (Option C4, C2 Serial Communications) Control Address: Set from 1 to 3FF (Options C4 and C2) This number (hexadecimal, base 16) must match the address number used by the host computer.
Not settable in this menu. To change this parameter, see **Addr** in the Secure Menu.

SECURE MENU

Hold **UP ARROW & ENTER** for 5 Seconds. Press **INDEX** to advance to the next menu item. Press **UP ARROW** or **DOWN ARROW** to change the value in the display. Press **ENTER** to retain the value.

OUTPUTS ARE DISABLED (TURNED OFF) WHILE CONTROL IS IN SECURE MENU.

SECr Security Code: See the Security Level Selection and the Password Table in this manual, in order to enter the correct password.

InP Input Type: Select one of the following. Refer to the Wiring section for the proper wiring.

J-10 Type "J" Thermocouple
KR Type "K" Thermocouple
E- Type "E" Thermocouple
t- Type "T" Thermocouple
L- Type "L" Thermocouple
n- Type "N" Thermocouple
r-13 Type "R" Thermocouple
S-10 Type "S" Thermocouple
b- Type "B" Thermocouple
C- Type "C" Thermocouple
P392 100 ohm Platinum (NIST 0.00392 / °C)
n120 120 ohm Nickel
P385 100 ohm Platinum (IEC/DIN 0.00385 / °C)
IP38 1000 ohm Platinum (IEC/DIN 0.00385 / °C)
Curr DC Current Input 0.0 to 20.0 or 4.0 to 20.0 mA.
Volt DC Voltage Input 0.0 to 10.0 or 1.0 to 10.0 volts.
dVFF DC Voltage Input -10 to +10 mV.
- - - - Reserved

OSUP Zero Suppression: Select On or OFF. Only with Current and Voltage input types.

OFF The input range will start at 0 (zero) Input.

On The input range will start at 4.00 mA or 1.00 V.

Unit F, C or none.

F °F descriptor is On and temperature inputs will be displayed in actual degrees Fahrenheit.

C °C descriptor is On and temperature inputs will be displayed in actual degrees Celsius.

none °F and °C descriptors will be Off. This is only available with Current and Voltage Inputs.

dPt Decimal Point Positioning: Select **0**, **0.0**, **0.00**, **0.000**, or **.0000**. On temperature type inputs a change here will alter the Process Value, SP1, SP2, ALLO, ALHi, and InPC. For current and voltage Inputs all Menu Items related to the Input will be affected.

0 No decimal Point is selected. This is available for all Input Types.



0.0 One decimal place is available for Type J, K, E, T, L, RTD's, Current and Voltage Inputs.

0.00 Two decimal places is only available for Current and Voltage Inputs.

0.000 Three decimal places is only available for Current and Voltage inputs.

.0000 Four decimal places is only available for Current and Voltage inputs.

INPt Input Fault Timer: Select **OFF**, **0.1** to **540.0** minutes. Whenever an Input is out of range (**UFL** or **DFL** displayed), shorted, or open, the timer will start. When the time has elapsed, the controller will revert to the output condition selected by **INPb** below. If **OFF** is selected, the Input Fault Timer will not be recognized (time = infinite).

SEnC Sensor Rate of Change: Select **OFF**, **1** to **4000** °F, °C, or counts per 1 second period. This value is usually set to be slightly greater than the fastest process response expected during a 1 second period, but measured for at least 2 seconds. If the process is faster than this setting, the **SEnC bAd** error message will appear. The outputs will then be turned off. This function can be used to detect a runaway condition, or speed up detection of an open thermocouple. Use the   **INDEX & ENTER** keys to reset.

SCAL Scale Low: Select 100 to 11998 counts below **SCAH**. The total span between **SCAL** and **SCAH** must be within 11998 counts. Maximum setting range is -1999 to +9999 counts. For Current and Voltage inputs, this will set the low range end. Value not adjustable for Thermocouple and RTD ranges.

SCAH Scale High: Select 100 to 11998 counts above **SCAL**. The total span between **SCAL** and **SCAH** must be within 11998 counts. Maximum setting range is -1999 to +9999 counts. For Current and Voltage inputs, this will set the high range end. Value not adjustable for Thermocouple and RTD ranges.

SPL Set Point Low: Select from the lowest input range value to **SPH** value. This will set the minimum SP1 or SP2 value that can be entered. The values for SP1 or SP2 will stop moving when this value is reached.

SPH Set Point High: Select from the highest input range value to **SPL** value. This will set the maximum SP1 or SP2 value that can be entered. The values for SP1 or SP2 will stop moving when this value is reached.

SP 10 Set Point 1 Output Select: Select **Outa** or **Outb**.

Outa Set Point 1 is routed through Output A, Set Point 2 (if equipped) is routed through Output B.

Outb Set Point 1 is routed through Output B, Set Point 2 (if equipped) is routed through Output A.

- SSt** Set Point 1 state : Select **d ir** or **rE**.
- d ir** Direct Action. As the input increases the output will increase. Most commonly used in cooling processes.
 - rE** Reverse Action. As the input increases the output will decrease. Most commonly used in heating processes.

If **Out 1** (Page 21) is set for **##tP**, **#PUL**, or **ProP**, then **S 10L** and **S 10H** appear. If **Out 1** is set for **OnOF**, then skip **S 1rE**.

S 10L Set Point Output Low Limit. Select 0 to 100% but not greater than **S 10H**. This item limits the lowest output value. This is useful for adding a bias to the process when needed. Factory set to 0 for output codes 1, 2, 3, 4, and 8. Factory set to 20 for output code 5 (20% output equals 4 mA output).

S 10H Set Point 1 Output High Limit. Select 0 to 100% but not less than **S 10L** for output codes 1, 2, 3, 4, or 8. Select 0 to 102% but not less than **S 10L** for output code 5. This item allows setting the maximum output limit. This is useful with processes that are over powered. Adjustment to 102% allows setting current output to force a full on condition for output devices which do not have bias adjustments. Factory set to 100 for all output codes.

If **Out 1** is set for **##tP**, **#PUL**, or **ProP**, then skip to **S 1LP** below.

If **Out 1** is set to **OnOF** (in Secondary Menu), then the next three menu items can make the **SP 1** and **SP 1d** settings act like a high or low alarm set point. See the information on alarm settings and the cautions and warnings that apply to them on Pages 30-31.

Note that when Set Point 1 Power Interrupt, **S 1P**, is On, and Set Point 1 Reset, **S 1rE**, is programmed to **Hold**, the **SP 1** output will automatically reset upon a power failure and subsequent restoration, if the process is below **SP 1**.

- S 1rE** Set Point 1 Reset. Select **OnOF** or **Hold**.
- OnOF** Output will automatically reset when process passes back through **SP 1d**.
 - Hold** Manual Reset. Reset by simultaneously pressing the   **INDEX & DOWN ARROW** keys for 3 seconds.

SP1 Set Point 1 Power Interrupt. Select **On** or **OFF**.
On Alarm Power Interrupt is **On**. Output will automatically reset on power-up if no alarm condition exists.
OFF Alarm Power Interrupt is **OFF**. Output will be in the alarm condition on power-up regardless of condition of process.

SP1H Set Point 1 Inhibit: Select **On** or **OFF**.
On Alarm Inhibit is On. Alarm action is suspended until the process value first enters a non-alarm condition.
OFF Alarm Inhibit is OFF.

SP1LP Set Point Lamp: Select **On** or **Off**.
On Lamp ON when Output is ON.
Off Lamp OFF when Output is ON.

If your control is not equipped with Set Point 2, then proceed to the alarm section (next page).

SP2 Set Point 2 type: Select **Ab** or **dE**.
AbS Absolute **SP2**. **SP2** is independent of **SP1**, and may be set anywhere between the limits of **SPL** and **SPH**.
dE Deviation **SP2**. **SP2** is set as a deviation from **SP1**, and allows **SP2** to retain its relationship with **SP1** when **SP1** is changed (**SP2** tracks **SP1**).

SP2St Set Point 2 State: Select **dir** or **rev**.
dir Direct Action. As the input increases the output will increase. Most commonly used in cooling processes.
rev Reverse Action. As the input increases the output will decrease. Most commonly used in heating processes.

If **Out2** is set for **##tP**, **#PUL**, or **Prop**, then **S20L** and **S20H** appear. If **Out2** is set for **OnOff**, then skip **S20L** and **S20H**.

S20L Set Point Output Low Limit: Select 0 to 100% but not greater than **S20H**. This item limits the lowest output value. This is useful for adding a bias to the process when needed. Factory set to 0 for output codes 1,2, 3, 4, and 8. Factory set to 20 for output code 5 (20% output equals 4 mA output).

S20H Set Point 2 Output High Limit: Select 0 to 100% but not less than **S20L** for output codes 1, 2, 3, 4, or 8. Select 0 to 102% but not less than **S20L** for output code 5. This item allows setting the maximum output limit. This is useful with processes that are over powered. Adjustment to 102% allows setting current output to

force a full on condition for output devices which do not have bias adjustments. Factory set to **100** for all output codes.

If **Out2** is set to **OnOF** (in the Secondary Menu), then the next three menu items can make the SP2 and SP2d settings act like a high or low alarm set point. See the information on alarm settings and the cautions and warnings that apply to them on the next pages.

Note that when Set Point 2 Power Interrupt, **SP2P**, is On, and Set Point 2 Reset, **SP2R**, is programmed to Hold, the **SP2** output will automatically reset upon a power failure and subsequent restoration, if the process is below **SP2**.

SP2R Set Point 2 Reset. Select **OnOF** or Hold.

OnOF Output will automatically reset when process passes back through **SP2d**.

Hold Manual Reset. Reset (acknowledge) by simultaneously pressing the **↶** **INDEX** & **DOWN ARROW** keys for 3 seconds.

SP2P Set Point 2 Power Interrupt. Select On or OFF.

On Alarm Power Interrupt is On. Output will automatically reset on power-up if no alarm condition exists.

OFF Alarm Power Interrupt is OFF. Output will be in the alarm condition on power-up regardless of condition of process.

SP2IH Set Point 2 Inhibit: Select On or OFF.

On Alarm Inhibit is On. Alarm action is suspended until the process value first enters a non-alarm condition.

OFF Alarm Inhibit is OFF.

SP2LP Set Point 2 Lamp: Select On or OFF.

On Lamp ON when Output is ON.

OFF Lamp OFF when Output is ON.

ALARM TYPE AND ACTION (if alarm function is present)



Caution: In any critical application where failure could cause expensive product loss or endanger personal safety, a redundant limit controller is required.

When setting an alarm value for an absolute alarm ($A1t = AbS$), simply set the value at which the alarm is to occur.

When setting the alarm value for a deviation alarm ($A1t = dE$), set the difference in value from the Set Point desired. For example if a low alarm is



required to be 5 degrees below the Set Point, then set A1Lo to -5. If a high alarm is required 20 degrees above the Set Point, then set A1Hi to +20. If the Set Point is changed, the alarm will continue to hold the same relationship as originally set.

The diagram below shows the action and reset functions for both absolute and deviation alarms.

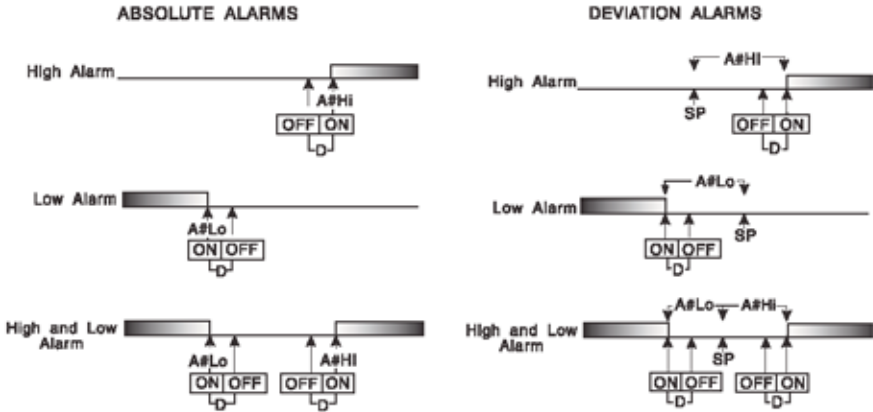
D = 1 degree F, 1 degree C, or 1 count.



Note that when Alarm Power Interrupt, A1Pi, is programmed ON and Alarm Reset, A1rE, is programmed for Hold, the alarm will automatically reset upon a power failure and subsequent restoration if no alarm condition is present.

If Alarm Inhibit, A1iH, is selected ON, an alarm condition is suspended upon power up until the process value passes through the alarm set point once. Alarm inhibit can be restored as if a power up took place by pressing both the   INDEX and ENTER keys for 3 seconds.





WARNING: IF INHIBIT IS ON AND A POWER FAILURE OCCURS DURING A HIGH ALARM, RESTORATION OF POWER WILL NOT CAUSE THE ALARM TO OCCUR IF THE PROCESS VALUE DOES NOT FIRST DROP BELOW THE HIGH ALARM SETTING. DO NOT USE THE ALARM INHIBIT FEATURE IF A HAZARD IS CREATED BY THIS ACTION. BE SURE TO TEST ALL COMBINATIONS OF HIGH AND LOW ALARM INHIBIT ACTIONS BEFORE PLACING CONTROL INTO OPERATION.

The following menu items apply only to the alarm.

- RL1** Alarm 1 function: Select **OFF**, **Lo**, **H1**, or **HLo**.
- OFF** Alarm 1 is disabled. No Alarm 1 menu items appear in the Secondary or Secure menus.
- Lo** Low Alarm Only. **RLo** appears in the Secondary Menu.
- H1** High Alarm Only. **RH1** appears in the Secondary Menu.
- HLo** High and Low Alarms. Both **RLo** and **RH1** appear in the Secondary Menu, and share the same Alarm 1 Relay output.

If **RL1** is set to **OFF** and the control is not equipped with options, the Secure Menu ends here. If **RL1** is set to **OFF** and the control is equipped with options, proceed to **Raddr** below.

- R1t** Alarm 1 Type: Select **ABS** or **dE**.
- ABS** Absolute Alarm that may be set anywhere within the values of **SCAL** and **SCRH** and is independent of **SP1**.
- dE** Deviation Alarm that may be set as an offset from **SP1**. As **SP1** is changed the Alarm Point will track with **SP1**.

- R1rE** Alarm 1 Reset: Select **OnOFF** or **Hold**.
- OnOFF** Automatic Reset.
- Hold** Manual Reset. Reset (acknowledge) by simultaneously pressing the   **INDEX & DOWN ARROW** keys for 3 seconds.

- R1P1** Alarm 1 Power Interrupt: Select **On** or **OFF**.
- On** Alarm Power Interrupt is **On**.
- OFF** Alarm Power Interrupt is **OFF**.

- R1iH** Alarm 1 Inhibit: Select **On** or **OFF**.
- On** Alarm Inhibit is **On**. Alarm action is suspended until the process value first enters a non-alarm condition.
- OFF** Alarm Inhibit is **OFF**.

- R1St** Alarm 1 Output State: Select **CLOS** or **OPEN**.
- CLOS** Closes Contacts at Alarm Set Point.
- OPEN** Opens Contacts at Alarm Set Point.

- A ILP** Alarm 1 Lamp: Select **On** or **Off**.
- On** Alarm Lamp is ON when alarm contact is closed.
 - Off** Alarm Lamp is OFF when alarm contact is closed.
- A ILb** Alarm 1 Loop Break. Select **On** or **Off**.
- On** Loop Break Condition will cause an Alarm Condition.
 - Off** Loop Break will not affect the Alarm Condition.
- Addr** (Option C2, C4, Serial Communications) Control Address: Set from **!** to **3FF** for Options C4 and C2. This number (hexadecimal, base 16) must match the address number used by the host computer. Power to instrument must be turned off and on before change takes effect (see Page 14).
- bAUD** (Option C2, C4, Serial Communications) Communication Baud Rate: Select **300, 1200, 2400, 4800, 9600** (baud), **19.2** or **28.8** (kbaud). This number must match the baud rate used by the host computer. Power to instrument must be turned off and on before change takes effect (see Page 14).
- nAt** (Option C2, C4, Serial Communications) No Activity Timer: Select **Off** or **!** to **99** minutes.
- !- 99** Maximum time between host computer accesses. If timer counts to 0, **TIME LOSE** will be displayed.
 - Off** No Activity Timer function is disabled.
- Stor** (Option C2, C4, Serial Communications) Store to EEPROM: Select **YES** or **no**. (See additional information on page 18).
- YES** Menu Item changes made through the Serial Communications are stored directly to the EEPROM.
 - no** Menu Item changes made through the Serial Communications are stored in RAM.

NOTES

ERROR MESSAGES

Any error message may be cleared by using the 'Global Reset' by pressing and holding the   INDEX & ENTER keys for five seconds.

DISPLAY	MEANING	SP OUTPUTS	ACTION REQUIRED
A-r-EA (Alternates with PV)	This message appears if the ambient temperature of the control approaches the ends of tolerance.	Set point outputs active. Alarm active.	Correct the ambient temperature conditions. Ventilate the area of the cabinet or check for clogged filters. If internal temperature sensor is broken (<i>RJC located in terminal 2</i>), return to service.
A-r-EA	This message appears if the ambient temperature of the control is out of range or RJC sensor is broken.	Set point outputs active. Alarm active.	Correct the ambient temperature conditions. Ventilate the area of the cabinet or check for clogged filters. If internal temperature sensor is broken, return for service.

ERROR MESSAGES

Any error message may be cleared by using the 'Global Reset' by pressing and holding the   INDEX & ENTER keys for five seconds.

DISPLAY	MEANING	SP OUTPUTS	ACTION REQUIRED
<p><i>UFL</i> or <i>OFL</i></p> <p><i>bad</i> <i>inP</i></p> <p><i>OPEN</i> <i>inP</i></p>	<p>Underflow or Overflow: Process value has exceeded input range ends.</p> <p><i>UFL</i> or <i>OFL</i> will sequence to display one of these messages if the InPt is set for a time value.</p> <p>For RTD inputs RTD is open or shorted. For THERMOCOUPLE inputs thermocouple is open.</p>	<p>Set point outputs active. Alarm active.</p> <p>Set point outputs inactive. Alarm active.</p>	<p>May be normal if Input signals go above or below range ends. If not the case, check sensor, input wiring and correct.</p> <p>When <i>inPt</i> (input fault timer) has been set for a time, the outputs will be turned off after the set time. Setting the time to <i>OFF</i> causes the outputs to remain active, however <i>UFL</i> or <i>OFL</i> will still be displayed.</p> <p>Correct or replace sensor.</p> <p>Clear with 'Global Reset'.</p>
<p><i>LOOP</i> <i>bad</i></p>	<p>The sensor may be defective, heater fuse open, heater open, or the final power output device is bad.</p>	<p>Set point outputs inactive. Alarm active.</p>	<p>Correct or replace sensor, or any element in the control loop that may have failed. Correct the problem.</p>
<p><i>SEnC</i> <i>bad</i></p>	<p>Sensor Rate of Change exceeded the programmed limits set for <i>SEnC</i>.</p>	<p>Set point outputs inactive. Alarm active.</p>	<p>Check for the cause of the error. The value setting may be too slow for the process, or the sensor is intermittent. Correct the problem.</p>
<p><i>CHEC</i> <i>CAL</i></p>	<p>Check calibration appears as an alternating message if the instrument calibration nears tolerance edges.</p> <p>Check calibration appears as a flashing message if the instrument calibration exceeds specification.</p>	<p>Set point outputs inactive. Alarm active.</p> <p>Set point outputs inactive. Alarm active.</p>	<p>Remove the instrument for service and / or recalibration.</p> <p>Remove the instrument for service and / or recalibration.</p>

ERROR MESSAGES

Any error message may be cleared by using the 'Global Reset' by pressing and holding the   INDEX & ENTER keys for five seconds.

DISPLAY	MEANING	SP OUTPUTS	ACTION REQUIRED
No display lighted	Display is blank. Instrument is not getting power, or the supply voltage is too low.	Set point outputs inactive. Alarm inactive	Check that the power supply is on, measure supply voltage, check that the external fuses are good.
FR IL tEst	Fail test appears upon power up if the internal diagnostics detect a failure. This message may occur during operation if a failure is detected. Displays flash. Fail test may also occur due to an EEPROM error.	Set point outputs inactive. Alarm inactive	The display alternates between FR IL tEst and one of the following messages: FRct dFLt : Memory may be corrupted. Restore to the factory default settings. Recheck controller programming. rEt FRct : Unrecoverable error. Return to service.
CHEC SP 1, CHEC SP 2, CHEC ISP, ..., CHEC 16SP	This message will appear upon power up if SP 1 , SP 2 , #SP 1 , or ##SP is set outside of the SPL or SPH values.	Set point outputs inactive. Alarm active	Correct the SP 1 , etc. or adjust the SPL or SPH values by programming new values.
CHEC SPL or CHEC SPH	This message appears at power up if SPL or SPH values are programmed outside the input range ends.	Set point outputs inactive. Alarm active	Correct the SPL or SPH values by programming new values.
CHEC rSPL	This message appears if the analog remote set point signal is out of range.	Set point outputs inactive. Alarm active	The control will revert to SP 1 . Correction of the analog signal or turning off the rSPL clears the error message.
CHEC LoRE	This message appears if the Serial Communications has timed out.	Set point outputs inactive. Alarm active	Change the LoRE to LOC . Restore the communications line and switch LoRE back to rE .

SPECIFICATIONS

Selectable Inputs: Thermocouple, RTD, DC Voltage, or DC Current selectable.

Input Impedance:

Thermocouple = 3 megohms minimum. RTD current = 200 μ A.

Current = 10 ohms. Voltage = 5000 ohms.

Sensor Break Protection: De-energizes control output to protect system after customer set time. (See InPt in Secure Menu.)

Set Point Range: Selectable (See Input Ranges Page 43).

Display: Two 4 digit, 7 segment 0.3" high LEDs.

Control Action: Reverse (usually heating), Direct (usually cooling) selectable.

Proportional Band: 1 to 9999 °F, °C, or counts.

Reset Time (Integral): Off or 0.1 to 99.9 minutes.

Rate Time (Derivative): Off or 0.01 to 99.99 minutes.

Cycle Rate: 1 to 80 seconds.

On - Off Differential: Adjustable 1° F, 1° C, or 1 count to full scale in 1° F, 1° C, or 1 count steps.

Alarm On - Off Differential: 1° F, 1° C, or 1 count.

Fuzzy Percent: 0 to 100%.

Fuzzy Rate: Off or 0.01 to 99.99 counts per second.

Fuzzy Band: Off or 1 to 4000 °F, °C, or counts.

Accuracy: \pm 0.25% of span, \pm 1 least significant digit.

Resolution: 1 degree or 0.1 degree, selectable.

Line Voltage Stability: \pm 0.05% over the supply voltage range.

Temperature Stability: 4 μ V/°C (2.3 μ V/°F) typical, 8 μ V/°C (4.5 μ V/°F)

maximum (100 ppm / °C typical, 200 ppm / °C maximum).

Common Mode Rejection: 140 db minimum at 60 Hz.

Normal Mode Rejection: 65 db typical, 60 db at 60 Hz.

Isolation:

Relay and SSR outputs: 1500 Vac to all other inputs and outputs.

SP1 and SP2 Current output: 500 Vac to all other inputs and outputs but not isolated from each other.

SP1 and SP2 Switched Voltage output: 500 Vac to all other inputs and outputs, but not isolated from each other.

Process Output (934, 936): 500 VAC to all other inputs and outputs.

Supply Voltage: 100 to 240 Vac, nominal, +10 -15%, 50 to 400 Hz. single phase; 132 to 240 Vdc, nominal, +10 -20%.

Supply Voltage (Option 9502): 12 to 24 Vdc, Vac 40-400 Hz, \pm 20%.

Power Consumption: 5VA maximum.

Operating Temperature: -10 to +55 °C (+14 to 131 °F).

Storage Temperature: -40 to +80 °C (-40 to 176 °F).

Humidity Conditions: 0 to 90% up to 40°C non-condensing, 10 to 50% at 55°C non-condensing.

Memory Backup: Nonvolatile memory. No batteries required.

Control Output Ratings:

SSR: 2.0 A combined outputs A & B @ 240 VAC at 25°C (77°F).

Derates to 1.0 A @ 55°C (130°F).

Relay: SPST, 3 A @ 240 VAC resistive; 1.5A @ 240 VAC inductive; Pilot duty rating 240 VA, 2 A @ 120 VAC or 1 A 240 VAC.

Alarm Relay: SPST, 3 A @ 240 VAC resistive; 1/10 HP @ 120 VAC.

Current (isolated): 0 to 20 mA across 600 ohms maximum.

Switched Voltage (isolated): 15 VDC @ 20 mA.

DC SSR: 1.75 A @ 32 Vdc maximum.

Panel Cutout: 45 mm x 45 mm (1.775" x 1.775").

Depth Behind Mounting Surface: 121.6 mm (4.79") maximum.

Weight: 220 g (8 oz).

Agency Approvals: UL, C-UL E83725

Front Panel Rating: IP66, (UL Type 4X).

-PV1 Analog Retransmission of PV/SV (Programmable)

Output: 0 to 20 mADC into 600 Ohms, maximum.

Isolation: 500 VAC.

Scale: Programmable from 100 to 11998 counts, depending on PV range selected.

-PV2 Analog Retransmission of PV/SV (Programmable)

Output: 0 to 10 VDC @ 20 mA maximum.

Isolation: 500 VAC.

Scale: Programmable from 100 to 11998 counts, depending on PV range selected.

-C2 RS-485 Series Communications

Port Compliance: EIA-485.

Isolation: 500 VAC.

Protocol: Lovelinks™ II.

Address Range: 001H or 3FFH.

Baud Rates: 300, 1200, 2400, 4800, 9600, 19.2k, 28.8k, 57.6k,

Mode: Half duplex.

Character: 8 bits, 1 start, 1 stop, no parity.

Number of units on line/ports¹: 32.

Cable Lengths¹: 6,000 ft (1,828 m).

Termination: 120 Ohms, balanced.

-C4 RS-232 Series Communications

Port Compliance: RS-232C.

Isolation: 500 VAC.

Protocol: Lovelinks™ II.

Address Range: 001H or 3FFH.

Baud Rates: 300, 1200, 2400, 4800, 9600, 19.2k, 28.8k, 57.6k.

Mode: Half duplex.

Character: 8 bits, 1 start, 1 stop, no parity.

Number of units on line/ports¹: 1.

Cable Lengths¹: 25 ft (7.6 m).

Termination: 120 Ohms, balanced.

- ¹ Number can be increased through use of a repeater such as the Mother Node™. Consult factory for details.

INPUT RANGES

INPUT TYPE	RANGE °F	RANGE °C
Type J or L ¹ Thermocouple	-100 to +1607	-73 to +871
Type K ¹ Thermocouple	-200 to +2500	-129 to +1371
Type T ¹ Thermocouple	-350 to +750	-212 to +398
Type E ¹ Thermocouple	-100 to +1800	-73 to +982
Type R Thermocouple	0 to 3200	-17 to +1760
Type S Thermocouple	0 to 3200	-17 to +1760
Type B Thermocouple	+75 to +3308	+24 to +1820
Type C Thermocouple	0 to 4208	-17 to +2320
Type N ¹ Thermocouple	-100 to +2372	-73 to +1300
100 Ω Plt. 0.00385 DIN ¹ RTD	-328 to 1607	-200 to +875
100 Ω Plt. 0.00392 NIST ¹ RTD	-328 to 1607	-200 to +875
120 Ω Nickel 0.00628 US ¹ RTD	-112 to +608	-80 to +320
1000 Ω Plt. 0.00385 DIN ¹ RTD	-328 to +1607	-200 to +875
Current/Voltage/ΔVoltage ²	Scalable Units from -1999 to +9999	

- ¹ These Input Types can be set for 0.1° display. If temperature goes above 999.9° or less than -199.9° the display will return to whole degree resolution.
- ² The 0 to 20 mADC, 4 to 20 mADC, 0 to 10 VDC, 2 to 10 VDC, and -10 to +10 mVDC inputs are fully scalable from a minimum of 100 counts span placed anywhere within the range of -1999 to +9999. Decimal point position is adjustable from the zero place (9999), tenths (999.9), hundredths (99.99), thousandths (9.999), or ten thousandths (.9999).

WARRANTY/DISCLAIMER

OMEGA ENGINEERING, INC. warrants this unit to be free of defects in materials and workmanship for a period of **13 months** from date of purchase. OMEGA's WARRANTY adds an additional one (1) month grace period to the normal **one (1) year product warranty** to cover handling and shipping time. This ensures that OMEGA's customers receive maximum coverage on each product.

If the unit malfunctions, it must be returned to the factory for evaluation. OMEGA's Customer Service Department will issue an Authorized Return (AR) number immediately upon phone or written request. Upon examination by OMEGA, if the unit is found to be defective, it will be repaired or replaced at no charge. OMEGA's WARRANTY does not apply to defects resulting from any action of the purchaser, including but not limited to mishandling, improper interfacing, operation outside of design limits, improper repair, or unauthorized modification. This WARRANTY is VOID if the unit shows evidence of having been tampered with or shows evidence of having been damaged as a result of excessive corrosion; or current, heat, moisture or vibration; improper specification; misapplication; misuse or other operating conditions outside of OMEGA's control. Components in which wear is not warranted, include but are not limited to contact points, fuses, and triacs.

OMEGA is pleased to offer suggestions on the use of its various products. However, OMEGA neither assumes responsibility for any omissions or errors nor assumes liability for any damages that result from the use of its products in accordance with information provided by OMEGA, either verbal or written. OMEGA warrants only that the parts manufactured by the company will be as specified and free of defects. OMEGA MAKES NO OTHER WARRANTIES OR REPRESENTATIONS OF ANY KIND WHATSOEVER, EXPRESSED OR IMPLIED, EXCEPT THAT OF TITLE, AND ALL IMPLIED WARRANTIES INCLUDING ANY WARRANTY OF MERCHANTABILITY AND FITNESS FOR A PARTICULAR PURPOSE ARE HEREBY DISCLAIMED. LIMITATION OF LIABILITY: The remedies of purchaser set forth herein are exclusive, and the total liability of OMEGA with respect to this order, whether based on contract, warranty, negligence, indemnification, strict liability or otherwise, shall not exceed the purchase price of the component upon which liability is based. In no event shall OMEGA be liable for consequential, incidental or special damages.

CONDITIONS: Equipment sold by OMEGA is not intended to be used, nor shall it be used: (1) as a "Basic Component" under 10 CFR 21 (NRC), used in or with any nuclear installation or activity; or (2) in medical applications or used on humans. Should any Product(s) be used in or with any nuclear installation or activity, medical application, used on humans, or misused in any way, OMEGA assumes no responsibility as set forth in our basic WARRANTY/DISCLAIMER language, and, additionally, purchaser will indemnify OMEGA and hold OMEGA harmless from any liability or damage whatsoever arising out of the use of the Product(s) in such a manner.

RETURN REQUESTS/INQUIRIES

Direct all warranty and repair requests/inquiries to the OMEGA Customer Service Department. BEFORE RETURNING ANY PRODUCT(S) TO OMEGA, PURCHASER MUST OBTAIN AN AUTHORIZED RETURN (AR) NUMBER FROM OMEGA'S CUSTOMER SERVICE DEPARTMENT (IN ORDER TO AVOID PROCESSING DELAYS). The assigned AR number should then be marked on the outside of the return package and on any correspondence.

The purchaser is responsible for shipping charges, freight, insurance and proper packaging to prevent breakage in transit.

FOR **WARRANTY** RETURNS, please have the following information available BEFORE contacting OMEGA:

1. Purchase Order number under which the product was PURCHASED,
2. Model and serial number of the product under warranty, and
3. Repair instructions and/or specific problems relative to the product.

FOR **NON-WARRANTY** REPAIRS, consult OMEGA for current repair charges. Have the following information available BEFORE contacting OMEGA:

1. Purchase Order number to cover the COST of the repair,
2. Model and serial number of the product, and
3. Repair instructions and/or specific problems relative to the product.

OMEGA's policy is to make running changes, not model changes, whenever an improvement is possible. This affords our customers the latest in technology and engineering.

OMEGA is a registered trademark of OMEGA ENGINEERING, INC.

© Copyright 2017 OMEGA ENGINEERING, INC. All rights reserved. This document may not be copied, photocopied, reproduced, translated, or reduced to any electronic medium or machine-readable form, in whole or in part, without the prior written consent of OMEGA ENGINEERING, INC.

Where Do I Find Everything I Need for Process Measurement and Control? **OMEGA...Of Course!** *Shop online at omega.com*

TEMPERATURE

- ☑ Thermocouple, RTD & Thermistor Probes, Connectors, Panels & Assemblies
- ☑ Wire: Thermocouple, RTD & Thermistor
- ☑ Calibrators & Ice Point References
- ☑ Recorders, Controllers & Process Monitors
- ☑ Infrared Pyrometers

PRESSURE, STRAIN AND FORCE

- ☑ Transducers & Strain Gages
- ☑ Load Cells & Pressure Gages
- ☑ Displacement Transducers
- ☑ Instrumentation & Accessories

FLOW/LEVEL

- ☑ Rotameters, Gas Mass Flowmeters & Flow Computers
- ☑ Air Velocity Indicators
- ☑ Turbine/Paddlewheel Systems
- ☑ Totalizers & Batch Controllers

pH/CONDUCTIVITY

- ☑ pH Electrodes, Testers & Accessories
- ☑ Benchtop/Laboratory Meters
- ☑ Controllers, Calibrators, Simulators & Pumps
- ☑ Industrial pH & Conductivity Equipment

DATA ACQUISITION

- ☑ Communications-Based Acquisition Systems
- ☑ Data Logging Systems
- ☑ Wireless Sensors, Transmitters, & Receivers
- ☑ Signal Conditioners
- ☑ Data Acquisition Software

HEATERS

- ☑ Heating Cable
- ☑ Cartridge & Strip Heaters
- ☑ Immersion & Band Heaters
- ☑ Flexible Heaters
- ☑ Laboratory Heaters

ENVIRONMENTAL MONITORING AND CONTROL

- ☑ Metering & Control Instrumentation
- ☑ Refractometers
- ☑ Pumps & Tubing
- ☑ Air, Soil & Water Monitors
- ☑ Industrial Water & Wastewater Treatment
- ☑ pH, Conductivity & Dissolved Oxygen Instruments