



User's Guide

iSeries



Shop on line at

omega.com[®]

Ω OMEGA[®]

www.omega.com

e-mail: info@omega.com

iSeries info:

www.omega.com/specs/iseries

For latest product manuals

www.omegamanual.info

**Temperature & Process
Simplified Menu (-SM) Manual
CNI8, CNI8C, CNI8D, CNI16, CNI16D, CNI32**



OMEGAnet® On-Line Service www.omega.com	Internet e-mail info@omega.com
--	--

Servicing North America:

USA: One Omega Drive, P.O. Box 4047
ISO 9001 Certified Stamford CT 06907-0047
TEL: (203) 359-1660 FAX: (203) 359-7700
e-mail: info@omega.com

Canada: 976 Bergar
Laval (Quebec) H7L 5A1
TEL: (514) 856-6928 FAX: (514) 856-6886
e-mail: info@omega.ca

For immediate technical or application assistance:

USA and Canada: Sales Service: 1-800-826-6342 / 1-800-TC-OMEGA®
Customer Service: 1-800-622-2378 / 1-800-622-BEST®
Engineering Service: 1-800-872-9436 / 1-800-USA-WHEN®

Mexico and Latin American: TEL: (001)800-TC-OMEGA® FAX: (001) 203-359-7807
En Español: (001) 203-359-7803
e-mail: espanol@omega.com

Servicing Europe:

Benelux: Postbus 8034, 1180 LA Amstelveen, The Netherlands
TEL: +31 20 3472121 FAX: +31 20 6434643
Toll Free in Benelux: 0800 0993344
e-mail: sales@omegaeng.nl

Czech Republic: Frystatska 184, 733 01 Karviná
TEL: +420 59 6311899 FAX: +420 59 6311114
e-mail: info@omegashop.cz

France: 11, rue Jacques Cartier, 78280 Guyancourt
TEL: +33 1 61 37 29 00 FAX: +33 1 30 57 54 27
Toll Free in France: 0800 466 342
e-mail: sales@omega.fr

Germany/Austria: Daimlerstrasse 26, D-75392 Deckenpfronn, Germany
TEL: +49 7056 9398-0 FAX: +49 7056 9398-29
Toll Free in Germany: 0800 639 7678
e-mail: info@omega.de

United Kingdom: One Omega Drive
ISO 9002 Certified River Bend Technology Centre
Northbank, Irlam Manchester M44 5BD United Kingdom
TEL: +44 161 777 6611 FAX: +44 161 777 6622
Toll Free in England: 0800 488 488
e-mail: sales@omega.co.uk

It is the policy of OMEGA to comply with all worldwide safety and EMC/EMI regulations that apply. OMEGA is constantly pursuing certification of its products to the European New Approach Directives. OMEGA will add the CE mark to every appropriate device upon certification.

The information contained in this document is believed to be correct but OMEGA Engineering, Inc. accepts no liability for any errors it contains, and reserves the right to alter specifications without notice.

WARNING: These products are not designed for use in, and should not be used for, patient connected applications.

 This device is marked with the international caution symbol. It is important to read the Setup Guide before installing or commissioning this device as it contains important information relating to safety and EMC.

TABLE OF CONTENTS

Part 1: Introduction.....	2
1.1 Description	2
1.2 Safety Considerations	3
1.3 Before You Begin	4
Part 2: Setup.....	5
2.1 Front Panel View	5
2.2 Rear Panel Connections	6
2.3 Electrical Installation	7
2.3.1 Power Connections	7
2.3.2 Thermocouple - Input Connection	8
2.3.3 Two / Three / Four Wire RTD-Hookups	9
2.3.4 Process Current - Wiring Hookup	10
2.3.5 Process Voltage - Wiring Hookup	10
2.3.6 Wiring Outputs - Wiring Hookup	11
Part 3: Operation: Configuration Mode	12
3.1 Introduction	12
Turning your Instrument On for the First Time	
Buttons Functions in Configuration Mode	
3.2 Menu Configuration	13
3.2.1 ID Number	14
3.2.2 Setpoints	15
3.2.3 Configuration Menu	16
3.2.4 Input Type Menu	17
Input Type (Thermocouple)	17
Input Type (RTD).....	18
Input Type (Process)	19
3.2.5 Reading Configuration Menu	20
3.2.6 Analog Output for Re-Transmission	23
3.2.7 Reading Adjust Menu	26
3.2.8 Setpoint Deviation Menu/Field Calibration	26
3.2.9 Alarm 1 Menu	28
3.2.10 Alarm 2 Menu	29
3.2.11 ID Code Menu	30
3.2.12 Communication (Options) Menu	32
3.2.13 Display Color Selection Menu	39
Part 4: Specifications	41
Part 5: Factory Preset Values	44
CE APPROVAL INFORMATION	45

LIST OF FIGURES:

Figure 2.1	Front Panel Display.....	5
Figure 2.2	Rear Panel Power and Output Connector Labels	6
Figure 2.3	Rear Panel Input Connector Labels	6
Figure 2.4	Main Power Connections	7
Figure 2.5	Thermocouple Wiring Hookup.....	8
Figure 2.6	Two/Three/Four-Wire RTD Wiring Hookup	
	a) RTD-1000 ohm/RTD-500 ohm	9
	b) RTD-100 ohm	9
Figure 2.7	Process Current Wiring Hookup (Internal and External Excitation).....	10
Figure 2.8	Process Voltage Wiring Hookup	
	a) With Sensor Excitation	10
	b) Without Sensor Excitation.....	10
Figure 2.9	Output Wiring Hookup	
	a) Mechanical Relay and SSR Outputs	11
	b) Pulse and Analog Outputs.....	11
Figure 2.10	Communication Output Wiring Hookup	
	a) RS-232 Output	11
	b) RS-485 Output	11
Figure 2.11	Excitation Output	11
Figure 3.1	Flow Chart for ID and Setpoints	13
Figure 3.2	Flow Chart for Configuration Menu.....	16
Figure 3.3	Flow Chart for Input Type Menu	17
Figure 3.4	Flow Chart for Reading Configuration	20
Figure 3.5	Flow Chart for Analog Output Re-Transmission	23
Figure 3.6	Flow Chart for Reading Adjust.....	26
Figure 3.7	Flow Chart for Setpoint Deviation/Field Calibration	26
Figure 3.8	Flow Chart for Alarm 1.....	28
Figure 3.9	Flow Chart for Alarm 2.....	29
Figure 3.10	Flow Chart for ID Code	30
Figure 3.11	Flow Chart for Communication Option	32
Figure 3.12	Flow Chart for Display Color Selection.....	39

LIST OF TABLES:

Table 2.1	Front Panel Annunciators	5
Table 2.2	Rear Panel Connector	6
Table 2.3	Power Connections	7
Table 2.4	TC Wire Color Chart	8
Table 3.1	Button Function in Configuration Mode.....	12
Table 3.2	Conversion Table	23
Table 4.1	Input Properties	43
Table 5.1	Factory Preset Values	44

NOTES, WARNINGS and CAUTIONS

Information that is especially important to note is identified by following labels:

- **NOTE**
- **WARNING or CAUTION**
- **IMPORTANT**



NOTE: Provides you with information that is important to successfully setup and use the Programmable Digital Meter.



CAUTION or WARNING: Tells you about the risk of electrical shock.



CAUTION, WARNING or IMPORTANT: Tells you of circumstances or practices that can effect the instrument's functionality and must refer to accompanying documents.



TIP: Provides you helpful hints.

PART 1

INTRODUCTION

1.1 Description

Note

This meter with simplified menu is an ON/OFF controller. It can also be purchased as monitor (read process value only), limit alarm meter or as a PID controller.

- The iSeries offers unparalleled flexibility in process measurement. Each unit allows the user to select the input type, from 10 thermocouple types (J, K, T, E, R, S, B, C, N and J DIN), Pt RTDs (100, 500 or 1000 Ω , with either 385 or 392 curve), DC voltage, or DC current. The voltage/current inputs are fully scalable to virtually all engineering units, with selectable decimal point, perfect for use with pressure, flow or other process input.
- The iSeries device features a large, three color programmable display with capability to change a color every time the Alarm is triggered. The standard features include built-in 24 Vdc @ 25 mA excitation for transmitters or other devices. (Built-in excitation is not available with optional isolated RS-232/485 Serial Communication). Universal power supply accepts 90 to 240 Vac. Low voltage power option accepts 24 Vac or 12 to 36 Vdc.

1.2 Safety Considerations



This device is marked with the international caution symbol. It is important to read this manual before installing or commissioning this device as it contains important information relating to Safety and EMC (Electromagnetic Compatibility).

This instrument is a panel mount device protected in accordance with EN 61010-1:2001, electrical safety requirements for electrical equipment for measurement, control and laboratory. Installation of this instrument should be done by qualified personnel. In order to ensure safe operation, the following instructions should be followed.



This instrument has no power-on switch. An external switch or circuit-breaker shall be included in the building installation as a disconnecting device. It shall be marked to indicate this function, and it shall be in close proximity to the equipment within easy reach of the operator. The switch or circuit-breaker shall meet the relevant requirements of IEC 947-1 and IEC 947-3 (International Electrotechnical Commission). The switch shall not be incorporated in the main supply cord.



Furthermore, to provide protection against excessive energy being drawn from the main supply in case of a fault in the equipment, an overcurrent protection device shall be installed.



- Do not exceed voltage rating on the label located on the top of the instrument housing.
- Always disconnect power before changing signal and power connections.
- Do not use this instrument on a work bench without its case for safety reasons.
- Do not operate this instrument in flammable or explosive atmospheres.
- Do not expose this instrument to rain or moisture.
- Unit mounting should allow for adequate ventilation to ensure instrument does not exceed operating temperature rating.
- Use electrical wires with adequate size to handle mechanical strain and power requirements. Install without exposing bare wire outside the connector to minimize electrical shock hazards.

EMC Considerations

- Whenever EMC is an issue, always use shielded cables.
- Never run signal and power wires in the same conduit.
- Use signal wire connections with twisted-pair cables.
- Install Ferrite Bead(s) on signal wires close to the instrument if EMC problems persist.

Failure to follow all instructions and warnings may result in injury!

1.3 Before You Begin

Inspecting Your Shipment:

Remove the packing slip and verify that you have received everything listed. Inspect the container and equipment for signs of damage as soon as you receive the shipment. Note any evidence of rough handling in transit. Immediately report any damage to the shipping agent. The carrier will not honor damage claims unless all shipping material is saved for inspection. After examining and removing the contents, save the packing material and carton in the event reshipment is necessary.

Customer Service:

If you need assistance, please call the nearest Customer Service Department, listed in this manual.

Manuals, Software:

The latest Operation and Communication Manual as well as free configuration software and ActiveX controls are available at **the website listed on the cover page of this manual or on the CD-ROM enclosed with your shipment.**



For first-time users: Refer to the QuickStart Manual for basic operation and set-up instructions.



If you have the Serial Communications/Ethernet Option you can easily configure the unit on your computer or on-line.

To Reset the Meter:



When the monitor is in the "MENU" Mode, **push  once** to direct monitor one step backward of the top menu item.

Push  twice to reset monitor, prior to resuming "Run" Mode except after "Alarms", that will go to the "Run" Mode without resetting the monitor.

PART 2
SETUP
2.1 Front Panel

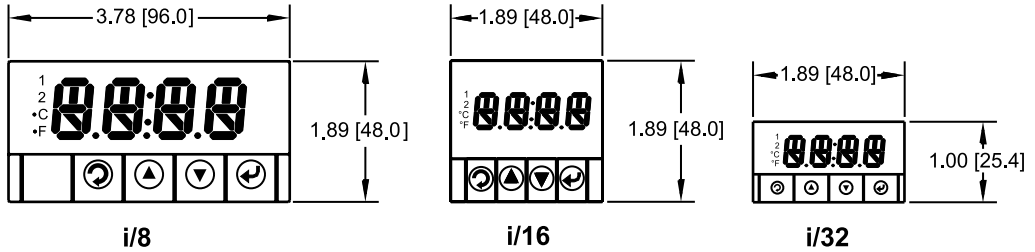

Figure 2.1 Front Panel Display

Table 2.1 Front Panel Annunciators

1	Setpoint 1/ Alarm 1 indicator
2	Setpoint 2/ Alarm 2 indicator
°C	°C unit indicator
°F	°F unit indicator
	Changes display to Configuration Mode and advances through menu items*
	Used in Program Mode and peak recall*
	Used in Program Mode and valley recall*
	Accesses submenus in Configuration Mode and stores selected values*

* See Part 3 Operation: Configuration Mode

Note

Refer to the Quick Start Guide for assembly and disassembly instructions.

2.2 Rear Panel Connections

The rear panel connections are shown in Figures 2.2 and 2.3.

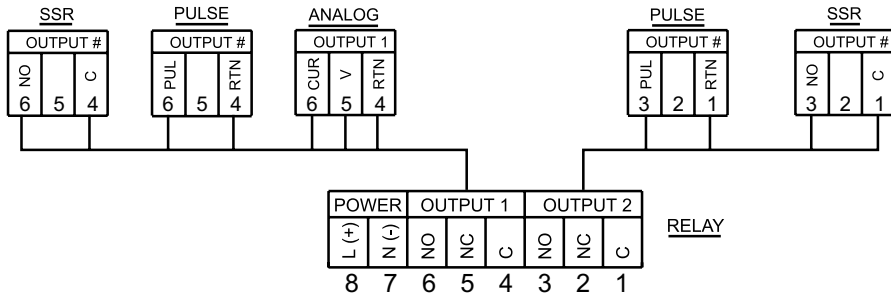

Figure 2.2 Rear Panel Power and Output Connections

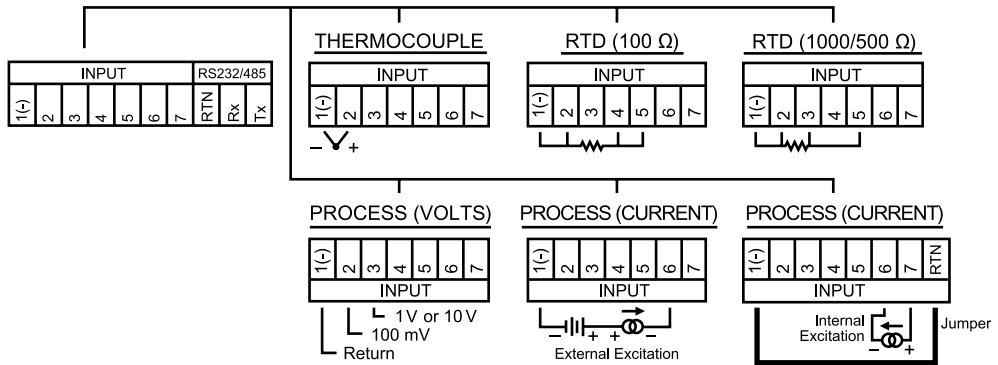

Figure 2.3 Rear Panel Input Connections

Table 2.2 Rear Panel Connector

POWER	AC/DC Power Connector: All models
INPUT	Input Connector: All models TC, PR (Process), RTD
OUTPUT 1	Based on one of the following models: Relay SPDT Solid State Relay Pulse ..Analog Output (Voltage and Current)
OUTPUT 2	Based on one of the following models: Relay SPDT Solid State Relay Pulse
OPTION	Based on one of the following models: RS-232C or RS-485 programmable Excitation

2.3 Electrical Installation

2.3.1 Power Connections



Caution: Do not connect power to your device until you have completed all input and output connections. Failure to do so may result in injury!

Connect the main power connections as shown in Figure 2.4.

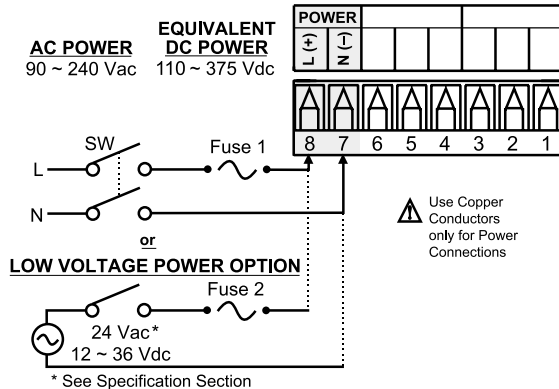

Figure 2.4 Main Power Connections

Table 2.3 Power Connections

FUSE	Connector	For 115Vac	For 230Vac	DC
FUSE 1	Power *	100 mA(T)	100 mA(T)	100 mA(T)
FUSE 2	Power *	N/A	N/A	400 mA(T)



For the low voltage power option, in order to maintain the same degree of protection as the standard high voltage input power units (90 - 240 Vac), always use a Safety Agency Approved DC or AC source with the same Overvoltage Category and pollution degree as the standard AC unit (90 - 240 Vac).



The Safety European Standard EN61010-1 for measurement, control, and laboratory equipment requires that fuses must be specified based on IEC127. This standard specifies for a Time-lag fuse, the letter code "T". The above recommended fuses are of the type IEC127-2-sheet III. Be aware that there are significant differences between the requirements listed in the UL 248-14/CSA 248.14 and the IEC 127 fuse standards. As a result, no single fuse can carry all approval listings. A 1.0 Amp IEC fuse is approximately equivalent to a 1.4 Amp UL/CSA fuse. It is advised to consult the manufacturer's data sheets for a cross-reference.

2.3.2 Thermocouple

The figure below shows the wiring hookup for any thermocouple type. For example, for Type K hookup, connect the yellow wire to the "2" terminal and the red wire to the "1(-)" terminal.

When configuring your monitor, select Thermocouple and Thermocouple Type in the Input Type menu (see Part 3).

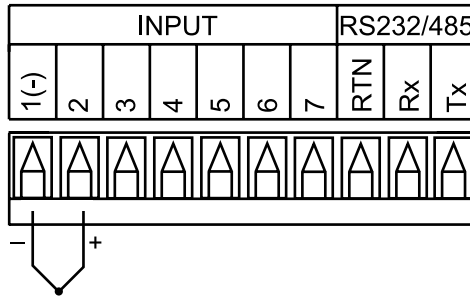

Figure 2.5 Thermocouple Wiring Hookup

Table 2.4 TC Wire Color Chart

TYPE	Input Connector		Jacket (external insulation)	
	Terminal 1 (-)	Terminal 2 (+)	Extension	Grade
J	Red	White	dark-Brown	Black
K	Red	Yellow	dark-Brown	Yellow
T	Red	Blue	dark-Brown	Blue
E	Red	Purple	dark-Brown	Purple
N	Red	Orange	dark-Brown	Brown
R	Red	Black	-	Green
S	Red	Black	-	Green
B	Red	Gray	-	Black

2.3.3 Two/Three/Four-Wire RTD

The figures below show the input connections and input connector jumpers (shown in bold lines) required to hookup a 2-, 3- or 4-wire RTD.

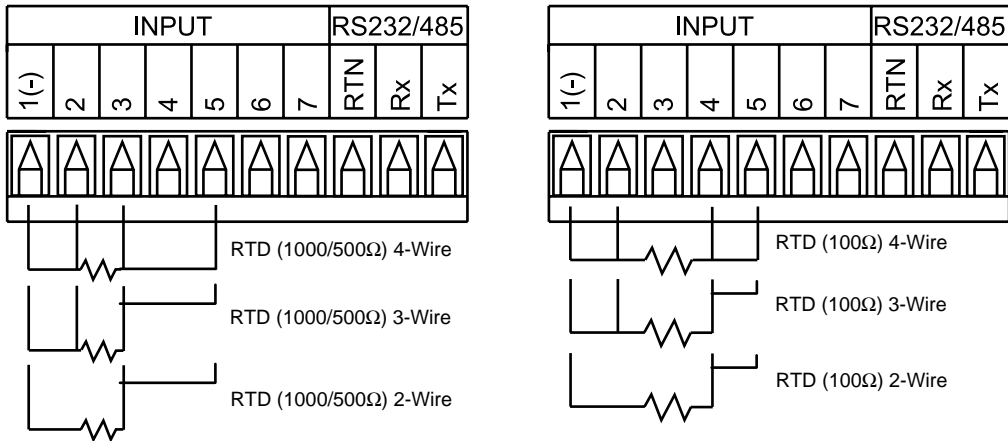

Figure 2.6 a) RTD-1000 ohm and 500 ohm Wiring Hookup

b) RTD-100 ohm Wiring Hookup

The **two-wire** connection is simplest method, but does not compensate for lead-wire temperature change and often requires calibration to cancel lead-wire resistance offset.

The **three-wire** connection works best with RTD leads closely equal in resistance. The device measures the RTD, plus upper and lower lead drop voltage and the subtracts twice the measured drop in the lower supply current lead producing excellent lead-resistance cancellation for balanced measurements.

The **four-wire** RTD hookup is applicable to unbalanced lead resistance and enables the device to measure and subtract the lead voltage, which produces the best lead-resistance cancellation.

When configuring your monitor, select RTD type and RTD value in the Input Type menu (see Part 3).

Note If the input wires of the meter get disconnected or broken, it will display **OPN** "Input (+) Open" message except in case of 500/1000 Ω 2-wire RTD. In this case the display shows **-OPN** "Input (-) Open" message. For safety purpose you may want to set up your alarm to be triggered when input is open. See Alarm 1 & 2 chapters for details.

2.3.4 Process Current

The figure below shows the wiring hookup for Process Current 0 – 20 mA.

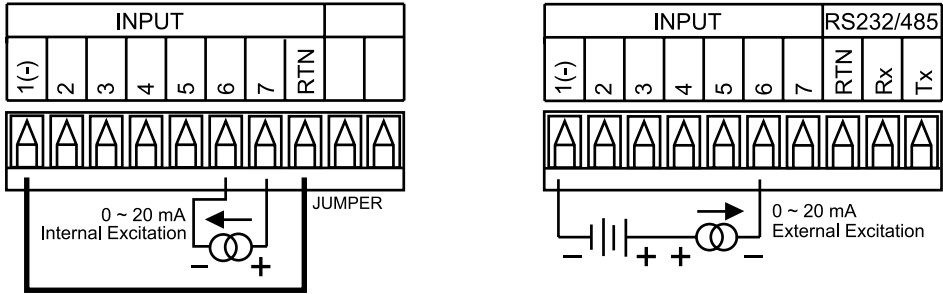

Figure 2.7 Process Current Wiring Hookup (Internal and External Excitation)

When configuring your instrument, select Process Type in the Input Type Menu (see Part 3).

2.3.5 Process Voltage

The figure below shows the wiring hookup for Process Voltage 0 – 100 mV, 0 – 1 V, 0 – 10 V.

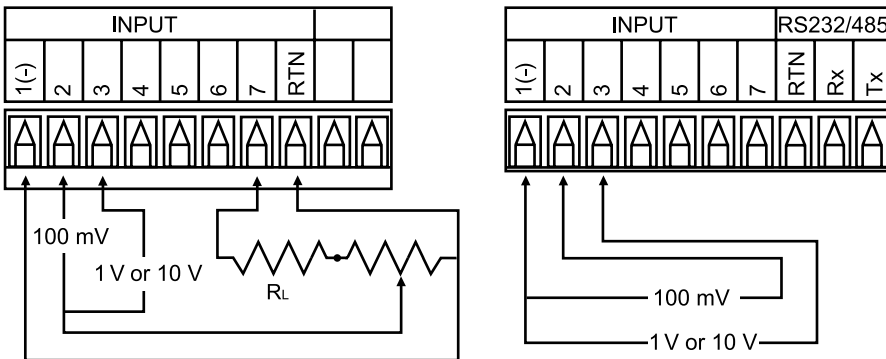

Figure 2.8
a) Process Voltage Wiring Hookup with Sensor Excitation **b) Process Voltage Wiring Hookup without Sensor Excitation**

RL - Voltage limited resistor, which allows to convert 24 Vdc internal excitation voltage to the appropriate process input value. For instance: if the potentiometer value is equal to 10 kΩ, the minimum RL is 14 kΩ for 10 V process input.

When configuring your instrument, select Process Type in the Input Type Menu (see Part 3).

2.3.6 Wiring Outputs

This meter has two, factory installed, outputs.

The SPDT Mechanical Relay, SPST Solid State Relay and Pulse Output Connection are shown below.

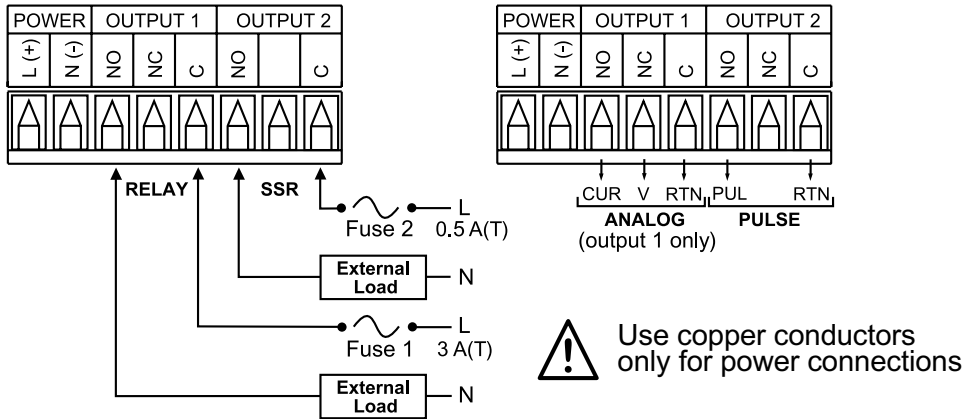

Figure 2.9

a) Mechanical Relay and SSR Outputs Wiring Hookup

b) Pulse and Analog Outputs Wiring Hookup

This device may have a programmable communication output. The RS-232 and RS-485 Output Connection are shown below.

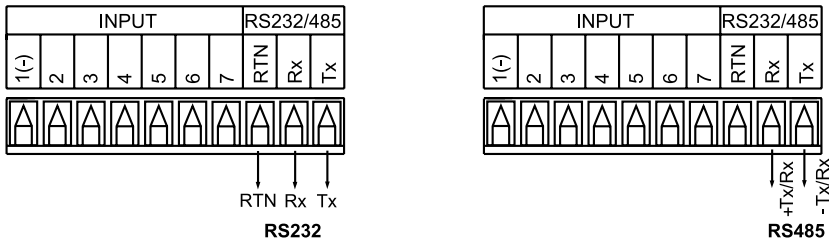
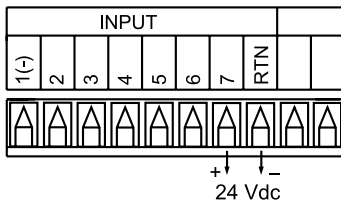

Figure 2.10

a) RS-232 Output Wiring Hookup

b) RS-485 Output Wiring Hookup

This device may also have an excitation output.



Note

Excitation is not available if communication option is installed.

Figure 2.11 Excitation Output

PART 3

OPERATION: Configuration Mode

3.1 Introduction

The instrument has two different modes of operation. The first, Run Mode, is used to display values for the Process Variable, and to display or clear Peak and Valley values. The other mode, Menu Configuration Mode, is used to navigate through the menu options and configure the unit. Part 3 of this manual will explain the Menu Configuration Mode. For your instrument to operate properly, the user must first "program" or configure the menu options.

Turning your Monitor On for the First Time

The device becomes active as soon as it is connected to a power source. It has no On or Off switch. The device at first momentarily shows the software version number, followed by reset **RSE**, and then proceeds to the Run Mode.

Tip ES

For first-time users: Refer to the QuickStart Manual for basic operation and set-up instructions.

Tip ES

If you have the Serial Communications/Ethernet Option you can easily configure the unit on your computer or on-line.

Table 3.1 Button Function in Configuration Mode

<p>⏪ (MENU)</p>	<ul style="list-style-type: none"> To enter the Menu, the user must first press ⏪ button. Use this button to advance/navigate to the next menu item. The user can navigate through all the top level menus by pressing ⏪. While a parameter is being modified, press ⏪ to escape without saving the parameter.
<p>⬆ (UP)</p>	<ul style="list-style-type: none"> Press the up ⬆ button to scroll through "flashing" selections. When a numerical value is displayed press this key to increase value of a parameter that is currently being modified. Holding the ⬆ button down for approximately 3 seconds will speed up the rate at which the set point value increments. In the Run Mode press ⬆ causes the display to flash the PEAK value – press again to return to the Run Mode.
<p>⬇ (DOWN)</p>	<ul style="list-style-type: none"> Press the down ⬇ button to go back to a previous Top Level Menu item. Press this button twice to reset the unit to the Run Mode. When a numerical value is flashing (except set point value) press ⬇ to scroll digits from left to right allowing the user to select the desired digit to modify. When a setpoint value is displayed press ⬇ to decrease value of a setpoint that is currently being modified. Holding the ⬇ button down for approximately 3 seconds will speed up the rate at which the setpoint value is decremented. In the Run Mode press ⬇ causes the display to flash the VALLEY value – press again to return to the Run Mode.
<p>⏩ (ENTER)</p>	<ul style="list-style-type: none"> Press the enter ⏩ button to access the submenus from a Top Level Menu item. Press ⏩ to store a submenu selection or after entering a value — the display will flash a SEt message to confirm your selection. To reset flashing Peak or Valley press ⏩. In the Run Mode press ⏩ twice to enable Standby Mode with flashing StBy.

Note ES

Reset: Except for Alarms, modifying any settings of the menu configuration will reset the instrument prior to resuming Run Mode.

3.2 Menu Configuration

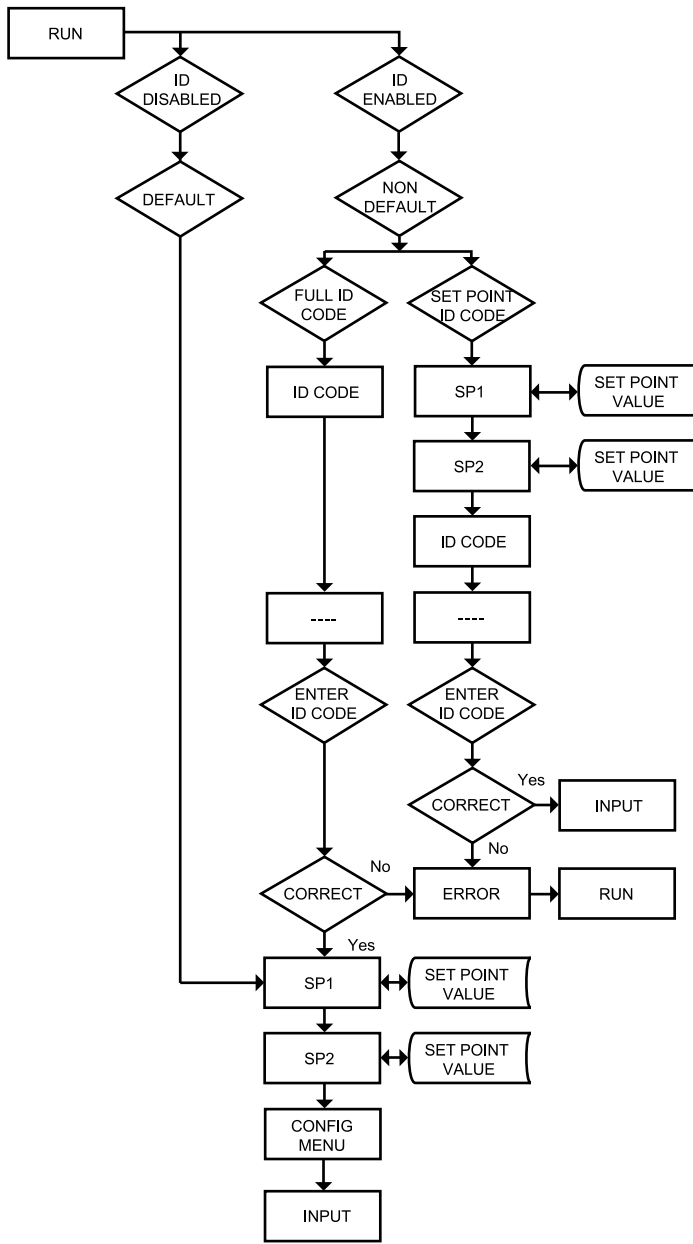

Figure 3.1 Flow Chart for ID and Set Points Menu

3.2.1 ID Number Menu









SEE ID MENU SELECTION IN CONFIGURATION SECTION FOR ENABLE/DISABLE OR CHANGE ID CODE.

Note  If ID Code is **Disabled** or set as **Default** (0000) the menu will skip ID step to Setpoint Menu.

If ID Code is set to **Full Security Level** and user attempts to enter the Main Menu, they will be prompted for an ID Code.









If ID Code is set to **Set Point/ID Security Level** and user attempts to enter the Configuration Menu, they will be prompted for an ID Code.

ENTERING YOUR NON-DEFAULT FULL SECURITY ID NUMBER.

- Press  1) Display shows **ID**.
- Press  2) Display advances to **----**.
- Press  &  3) Press  to increase digit 0-9. Press  to activate next digit (flashing). Continue to use  and  to enter your 4-digit ID code.
- Press  4) If the correct ID code is entered, the menu will advance to the Setpoint 1 Menu, otherwise an error message **ERR** will be displayed and the instrument will return to the Run Mode.

Note  To change ID Code, see ID Menu in the Configuration section.

ENTERING YOUR NON-DEFAULT SET POINT/ID SECURITY ID NUMBER.







- Press  5) Display shows **SP1** Setpoint 1 Menu.
- Press  6) Display shows **SP2** Setpoint 2 Menu.
- Press  7) Display shows **ID** ID Code Menu.
- Press  8) Display advances to **----**.
- Press  &  9) Use  and  to change your ID Code.
- Press  10) If correct ID Code is entered, the display will advance to the **INPE** Input Menu, otherwise the error message **ERR** will be displayed and the unit will return to the Run Mode.



Note  To prevent unauthorized tampering with the setup parameters, the instrument provides protection by requiring the user to enter the ID Code before allowing access to subsequent menus. If the ID Code entered does not match the ID Code stored, the unit responds with an error message and access to subsequent menus will be denied.







Tip  Use numbers that are easy for you to remember. If the ID Code is forgotten or lost, call customer service with your serial number to access and reset the default to **0000**.

3.2.2 Set Points Menu





SETPOINT 1:



- Press  1) Press , if necessary until **SP 1** prompt appears.
Press  2) Display shows previous value of "Setpoint 1".
Press  &  3) Press  and  to increase or decrease Setpoint 1 respectively.



Note  Holding  &  buttons down for approximately 3 seconds will speed up the rate at which the Setpoint value increments or decrements.

- Press  &  4) Continue to use  and  to enter your 4-digit Setpoint 1 value.
Press  5) Display shows **SETRd** stored message momentarily and then advance to **SP 2** only, if a change was made, otherwise press  to advance to **SP 2** Setpoint 2 Menu.

SETPOINT 2:

- Press  6) Display shows previous value of "Setpoint 2".
Press  &  7) Press  and  to increase or decrease Setpoint 2 respectively.

Note  Holding  &  buttons down for approximately 3 seconds will speed up the rate at which the setpoint value increments or decrements.

- Press  8) Display shows **SETRd** stored message momentarily and then advances to **CNFG** only, if a change was made, otherwise press  to advance to **CNFG** Configuration Menu.

3.2.3 Configuration Menu

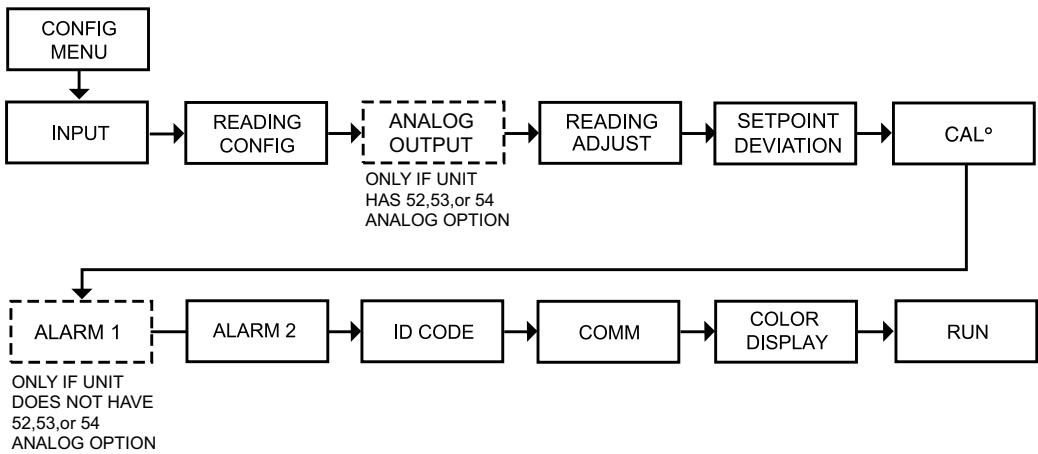

Figure 3.2 Flow Chart for Configuration Menu

Enter Configuration Menu:

- Press
 - Press
 - Press
- 1) Press , if necessary, until **CONF** prompt appear.
 - 2) Display advance to **INPE** Input Menu.
 - 3) Press and release to scroll through all available menus of Configuration section.



If Analog Output Option is installed (52, 53, or 54), the controller will skip Alarm 1 Menu item to Alarm 2 Menu.

3.2.4 Input Type Menu

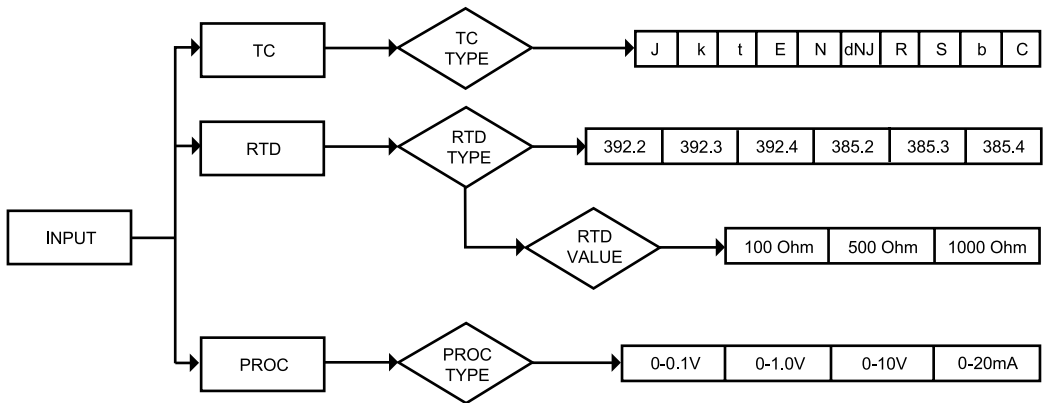

Figure 3.3 Flow Chart for Input Type Menu

Input Type (Thermocouple)

ENTER INPUT TYPE MENU:

- Press 1) Press , if necessary, until **CONF** prompt appears.
- Press 2) Display advances to **INPE** Input Menu.
- Press 3) Display flashes **E.C**, **Rtd** or **PROC** (Thermocouple, RTD or Process). If the displayed input type is **E.C**, press to skip to step 6 (**E.C** stops flashing).

THERMOCOUPLE SUBMENU:

- Press 4) Scroll through the available selection to **E.C** (flashing).
- Press 5) Display shows **SEEd** stored message momentarily and then **E.C** (not flashing).
- Press 6) Display flashes previous thermocouple type selection. i.e. **J** (see below for types).
- Press 7) Scroll through the available thermocouple types to the selection of your choice.
- Press 8) Display shows **SEEd** stored message momentarily and then advances to the **RdU** Reading Configuration Menu.



Use the Input Type (Thermocouple) (RTD) or (Process) and verify your Electrical Installation (see **Section 2.3**).

Thermocouple Types: J, K, T, E, N, DIN J, R, S, B, C
Display: **J K E E N dNJ R S b C**

Input Type (Process)

ENTER INPUT TYPE MENU:

- Press **↻** 1) Press **↻**, if necessary, until **CONF** prompt appears.
- Press **↻** 2) Display advance to **INPE** Input Menu.
- Press **↻** 3) Display flashes **TC**, **RTD** or **PROC** (Thermocouple, RTD or Process). If the displayed input type is **PROC**, press **↻** to skip to step 6 (**PROC** stops flashing).

PROCESS SUBMENU:

- Press **▲** 4) Scroll through the available selection to **PROC** (flashing).
- Press **↻** 5) Display shows **STRD** stored message momentarily and then **PROC** (not flashing).
- Press **↻** 6) Display flashes previous Process type selection. i.e. **0-10** (see below for Process types selection).
- Press **▲** 7) Scroll through the available Process types to the selection of your choice.
- Press **↻** 8) Display shows **STRD** stored message and then advances to **RdC** Reading Configuration Menu.

Process Types: 100 mV 1 V 10 V 0 – 20 mA

Display: **0-0.1** **0-1.0** **0-10** **0-20**

For 4-20 mA Input select 0-20 mA then adjust the Input/Reading accordingly.
To adjust 4-20 mA input, see example under INPUT/READING Submenu. The factory preset value is 4-20 mA.

3.2.5 Reading Configuration Menu

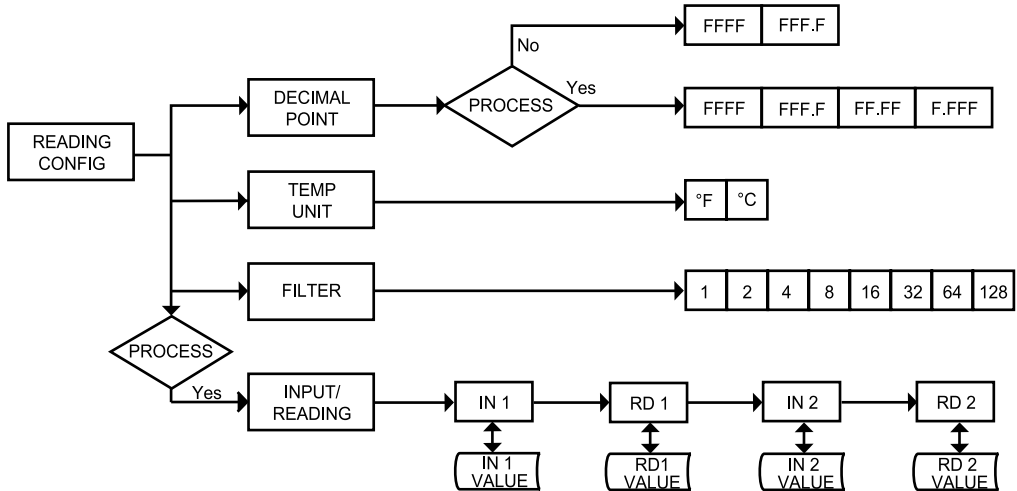

Figure 3.4 Flow Chart for Reading Configuration Menu

ENTER READING CONFIGURATION MENU:

- Press 1) Press , if necessary, until **ENFC** prompt appears.
- Press 2) Display advances to **INPE** Input Menu.
- Press 3) Display advances to **RdG** Reading Configuration Menu.
- Press 4) Display advances to **DEC** Decimal Point.



DECIMAL POINT SUBMENU:

- Press 5) Display flashes previous selection for Decimal location.
- Press 6) Scroll through the available selections and choose Decimal location: **FFFF** or **FFF.F** (also **FF.FF** and **F.FFF** — if **PROC** Process type was selected in the Input Type Menu).
- Press 7) Display shows **SEEd** stored message momentarily and then advances to **TEMP** Temperature Unit.





Note

Decimal Point for Process Input Type is passive.

TEMPERATURE UNIT SUBMENU:

- Press  8) Display flashes previous Temperature Unit selection.
- Press  9) Scroll through the available selections to the Temperature Unit of your choice: **F** or **C**.
- Press  10) Display shows **SEtRd** stored message momentarily and then advances to **FLtR** Filter Constant.

FILTER CONSTANT SUBMENU:

- Press  11) Display flashes previous selection for Filter Constant.
- Press  12) Scroll through the available selections:
0001, 0002, 0004, 0008, 0016, 0032, 0064, 0128
- Press  13) Display shows **SEtRd** stored message momentarily only, if change were made, otherwise press  to advance to the next menu.



If Process was selected in the Input Type Menu the display will advance to **IN.Rd** Input/Reading Submenu, otherwise the display advances to the **ALR1** Alarm 1 Menu.

The Filter Constant Submenu allows the user to specify the number of readings stored in the Digital Averaging Filter. A filter value of 2 is approximately equal to 1 second RC low pass time constant.

Reading Configuration (If Process was selected)

INPUT/READING (SCALE AND OFFSET) SUBMENU:

Input Voltage or Current can be converted or scaled into values appropriate for the process or signal being measured. So, a reading may be displayed, for example, in units of weight or velocity instead of in amperes or volts.

The instrument determines Scale and Offset values based on two user-provided input values entered with the corresponding readings. Note that “In1” Input 1 and “In2” Input 2 are represented and entered as a product of the input voltage/current and the conversion number from the Table 3.1.

Note The following instructions include details for a specific scenario in which a 4-20 mA input (in the 20 mA Process Mode) is to be represented as a measurement of 0-100 percent.

- Press **↻** 14) Press **↻** at the **IN.Rd** prompt. Display shows **IN 1** Input 1 submenu.
- Press **↻** 15) Display shows Input 1 value with 1st digit flashing.
- Press **▲ & ▼** 16) Use **▲** and **▼** buttons to enter **IN 1** value.
The **IN 1** value = min. input value * conversion number.

Note Disregard the position of the decimal point (2000 counts may actually appear as “200.0”, “20.00”, or “2.000”).
Example: 4 mA as 4(mA) x 500 = 2000.

- Press **↻** 17) Display advances to **Rd 1** Reading 1 Submenu.
- Press **▲ & ▼** 18) Use **▲** and **▼** buttons to enter **Rd 1** value.
This value represents **IN 1** in terms of some meaningful engineering units. To show the 4 mA as zero percent enter **Rd 1** value = 0000.
Example: **Rd 1** value = 0000.
- Press **↻** 19) Display shows **IN 2** Input 2 Submenu.
- Press **↻** 20) Display shows Input 2 value with 1st digit flashing.
The **IN 2** value = max. input value * conversion number.
Example: 20(mA) x 500 = 10000 (9999).
- Press **▲ & ▼** 21) Use **▲** and **▼** buttons to enter **IN 2** value.
- Press **↻** 22) Display advances to **Rd 2** Reading 2 Submenu.
- Press **▲ & ▼** 23) Use **▲** and **▼** buttons to enter **Rd 2** value.
Example: **Rd 2** value = 0100.
- Press **↻** 24) Display flashes **SE Rd** stored message momentarily and then advances to **ALR 1** only, if change were made, otherwise press **↻** to advance to **ALR 1** Alarm 1 Menu.



Conversion number is a coefficient of conversion between input values and real full display range (10000 counts). See **Table 3.2** below for proper conversion number.

Table 3.2 Conversion Table

RANGE	CONVERSION NUMBER
100 mV	$10000 / (100 \times 1) = 100$
1 V	$10000 / (1000 \times 1) = 10$
10 V	$10000 / (1000 \times 10) = 1$
0 -20 mA	$10000 / (20 \times 1) = 500$

3.2.6 Analog Output (Re-transmission)

Analog Output is available only, if option board is factory installed. If Analog Output Option is not installed, the instrument will skip to Reading Adjust Menu.

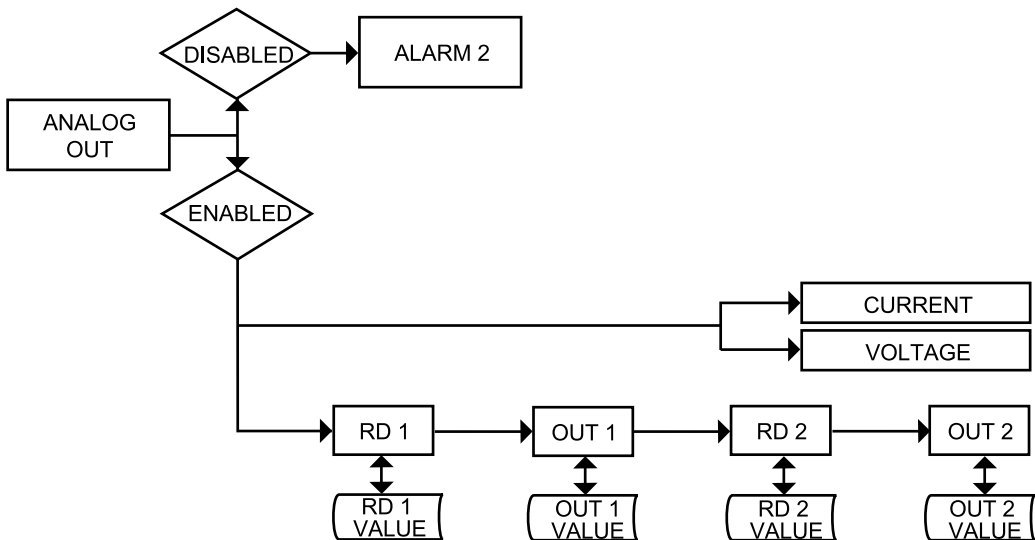

Figure 3.5 Flow Chart for Analog Output (Re-transmission)

ENTER ANALOG OUTPUT MENU:

- Press **⏏** 1) Press **⏏**, if necessary, until **ENFG** prompt appears.
- Press **⏏** 2) Display advances to **INPE** Input Menu.
- Press **⏏** 3) Press **⏏**, if necessary, until Display advances to **ANLG** Analog Output Menu.
- Press **⏏** 4) Display advances to Analog Output **ENBL** Enable or **DSBL** Disable Submenu and flashes the previous selection.

ANALOG OUTPUT ENABLE/DISABLE SUBMENU:

- Press **▲** 5) Scroll through the available selection until **ENBL** displays to use Analog Output Retransmission (output proportional to the input signal).
- Press **◀** 6) Display shows **STRD** stored message momentarily and then advances to **CURR** or **VOLT** Submenu only if it was changed, otherwise press **▶** to advance to **CURR** or **VOLT** Current/Voltage Submenu.

Note If **DSBL** Analog Output **Disabled** was selected, all submenus of Analog Output Menu will be skipped and the meter will advance to **ALR2** Alarm 2 Menu. If **ENBL** Analog Output **Enabled** was selected, Output 1 would be automatically **Disabled**, and reassigned as Analog Output.

CURRENT/VOLTAGE SUBMENU:

- Press **▶** 7) Display flashes **CURR** Current or **VOLT** Voltage.
- Press **▲** 8) Scroll through the available selection: Current or Voltage (Example **VOLT**).
- Press **◀** 9) Display shows **STRD** stored message momentarily and then advances to **Rd1** Submenu only if it was changed, otherwise press **▶** to advance to **Rd1** Reading 1 Submenu.

READING 1:

- Press **▶** 10) Display flashes 1st digit of previous "Reading 1" value.
- Press **▲** & **▼** 11) Enter "Reading 1" value. (Example 0000)
- Press **▶** 12) Display advances to **OUT.1** Out 1 Submenu.

OUT 1:

- Press **▶** 13) Display flashes 1st digit of previous "Out 1" value.
- Press **▲** & **▼** 14) Enter "Out 1" value. (Example 00.00)
- Press **▶** 15) Display advances to **Rd2** Reading 2 Submenu.

READING 2:

- Press **▶** 16) Display flashes 1st digit of previous "Reading 2" value.
- Press **▲** & **▼** 17) Enter "Reading 2" value. (Example 9999)
- Press **▶** 18) Display advances to **OUT.2** Out 2 Submenu.

OUT 2:

- Press **▶** 19) Display flashes 1st digit of previous "Out 2" value.
- Press **▲** & **▼** 20) Enter "Out 2" value. (Example 10.00)
- Press **▶** 21) Display advances to the **ALR2** Alarm 2 Menu.

Note The above example is for 0-10 V of the entire range of the Process Input and Analog Output. For 0-20 mA output you need to set "Analog Type" to Current and OUT 2 to 20.00.

Accuracy of Analog Output board is +/-1% of FS (Full Scale) when following conditions are satisfied:

1. The input is not scaled below 1% of Input FS (10 mV @ 1 V or 0.2 mA @ 20 mA input ranges).
2. Analog Output is not scaled below 3% of Output FS (300 mV @ 10 V or 0.6 mA @ 20 mA output ranges).

Otherwise certain corrections need to be applied.

For example:

For entire range of process input, the Analog Output on 10 V FS scaled for **300 mV** output range:

$$\begin{aligned} \text{Rd1} &= 0000, & \text{Out1} &= 00.00 \\ \text{RD2} &= 9999, & \text{Out2} &= 00.30 \end{aligned}$$

The **measured output** will be as follows:

$$\begin{aligned} \text{Rd1} &= 0000, & \text{Out1} &= -0.07 \text{ V} \\ \text{Rd2} &= 9999, & \text{Out2} &= 0.23 \text{ V} \end{aligned}$$

This means that for 300 mV output range we have -70 mV offset at zero and at full scale. In order to compensate this 70 mV offset the **correct scaling** will be as follows:

$$\begin{aligned} \text{Rd1} &= 0000, & \text{Out1} &= 00.07 \\ \text{Rd2} &= 9999, & \text{Out2} &= 00.37 \end{aligned}$$

The above corrections need to be applied only for **Input scaled below 1% of FS** and **Output scaled below 3% of FS** or if you need the **Analog Output accuracy to be better than 1% of FS**.

3.2.7 Reading Adjust Menu



For Temperature Reading only, not Process

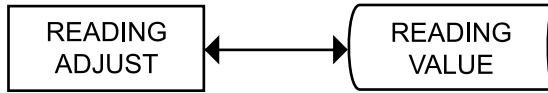

Figure 3.6 Flow Chart for Reading Adjust Menu

ENTER READING ADJUST MENU:

- Press **⏏** 1) Press **⏏**, if necessary, until **ENFG** prompt appears.
- Press **⏏** 2) Display advances to **INPE** Input Menu.
- Press **⏏** 3) Press **⏏**, if necessary, until Display advances to **R.AdJ** Reading Adjust Menu.

READING ADJUST VALUE SUBMENU:

- Press **⏏** 4) Display flashes 1st digit of previous Reading Adjust value.
- Press **▲** & **▼** 5) Press **▲** and **▼** buttons to enter a new Reading Adjust value (-1999 to 9999).
- Press **⏏** 6) Display shows **SErD** stored message momentarily and then advances to **SP.dV** Setpoint Deviation Menu.

Reading Offset Adjust allows the user to fine tune a minor error of the transducer, however some applications may require a large offset adjust. (Displayed Process Value = Measured Process Value ±R.ADJ). Reading Adjust value is adjustable between -1999 to 9999.

3.2.8 Setpoint Deviation Menu / Field Calibration Menu

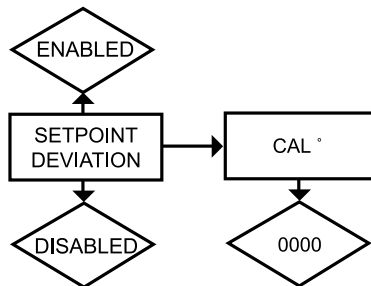





Figure 3.7 Flow Chart for Setpoint Deviation / Field Calibration

ENTER SETPOINT DEVIATION MENU:

- Press **⏏** 1) Press **⏏**, if necessary, until **ENFG** prompt appears.
- Press **⏏** 2) Display advances to **INPE** Input Menu.
- Press **⏏** 3) Press **⏏**, if necessary, until Display advances to **SP.dV** Setpoint Deviation Menu.

3.2.9 Setpoint Deviation Menu / Field Calibration(continued)

SETPOINT DEVIATION ENABLE/DISABLE SUBMENU:

- Press  4) Display advances to Setpoint Deviation **ENbL** Enable or **DSbL**. Disable Submenu and flashes the previous selection.
- Press  5) Scroll through the available selections: **ENbL** or **DSbL**.
- Press  6) Display shows **SERR** stored message momentarily and then advances to the next menu item.

Setpoint Deviation menu, if “enabled”, allows changes to Setpoint 1 to be made automatically to Setpoint 2. This mode is very helpful if the Process value changes often. In Setpoint Deviation Mode, set SP2 a certain number of degrees or counts away from SP1 - this relation remains fixed when SP1 is changed. For instance: Setting SP1=200 and SP2=20 and enabling **SP.dV** means that the absolute value of SP2=220. Moving SP1 to 300, the absolute value of SP2 becomes 320.

Thermocouple Field Calibration Menu:



CAUTION: Do not perform the following steps until you fully understand this entire section.







RTD and Process are perfectly calibrated. This section is applicable to Thermocouple (TC) calibration *only*.

Be sure that the TC being used to calibrate the meter is of the type selected in the TC submenu. Place the TC in an ice-bath (or other **0°C / 32°F** environment). In ambient temperature conditions: connect the TC to the meter, apply power to the meter.



CAUTION: Do not proceed with TC calibration unless the above conditions have been in effect for at least one hour.

- Press  7) Display shows **CAL°**.
- Press  8) Display shows flashing **0000**.
- Press  * 9) Display will still show flashing **0000**.
- Press  * 10) Display shows **00E1** (meaning Calibration is complete)

* If you accidentally engage the flashing **0000** (CAL° alert) simply re-press the last button you pressed, to avoid unintentionally mis-calibrating your meter.

3.2.8 Alarm 1 Menu

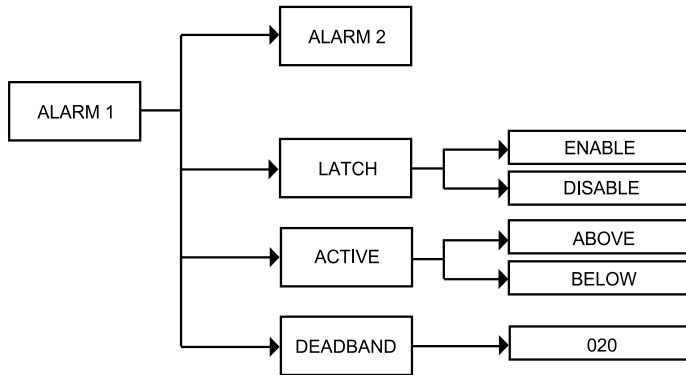

Figure 3.8 Flow Chart for Alarm 1 Menu

ENTER ALARM 1 MENU:

- Press **⏏** 1) Press **⏏**, if necessary, until **CONF** prompt appears.
- Press **⏏** 2) Display advances to **INPE** Input Menu.
- Press **⏏** 3) Press **⏏**, if necessary, until display advances to **ALR1** Alarm 1 Menu.
- Press **⏏** 4) Display advances to **LATCH** Latch.

ALARM 1 LATCH SUBMENU:

- Press **⏏** 5) Display flashes previous selection. Press **⏏** to **ENBL** Enable or **DSBL** Disable.
- Press **⏏** 6) Display shows **STRD** stored message momentarily and then advances to **ACTN** only, if it was changed, otherwise press **⏏** to advance to **ACTN** Active Submenu.

Latch Enabled: Alarm remains "latched" until reset. To reset already latched alarm, select Alarm Latch Enable and press Max twice (i.e. Disable and then go back to Latch) or from a Run Mode, push **⏏** twice to put the monitor in Standby Mode and then push **⏏** one more time to return to the Run Mode.

Latch Disabled: Alarm remains latched only as long as the alarm condition is true.

ACTIVE SUBMENU:

- Press **⏏** 7) Display flashes previous selection. Press **⏏** to **ABOV** Above, or **BELO** Below.
- Press **⏏** 8) Display shows **STRD** stored message momentarily and then advances to **DEAD** Deadband.

DEADBAND SUBMENU:

- Press **⏏** 9) Display shows **020.0** Deadband value that can be changed by pressing **⏏** or **⏏**.
- Press **⏏** 10) Display shows **STRD** stored message momentarily and then advances to **ALR2** Alarm 2.

3.2.9 Alarm 2 Menu

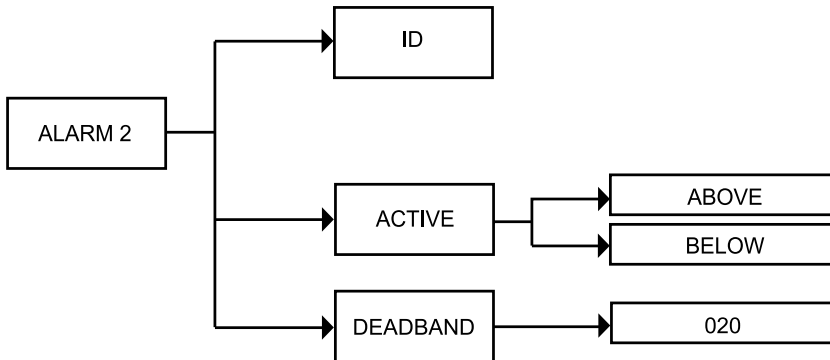

Figure 3.9 Flow Chart for Alarm 2 Menu

ENTER ALARM 2 MENU:

- Press **⏏** 1) Press **⏏**, if necessary, until **CONF** prompt appears.
- Press **⏏** 2) Display advances to **INPT** Input Menu.
- Press **⏏** 3) Press **⏏**, if necessary, until display advances to **ALR2** Alarm 2 Menu.
- Press **⏏** 4) Display advances to **ACTV** Active Submenu.

ACTIVE SUBMENU:

- Press **⏏** 5) Display flashes previous selection. Press **▲** to **ABOV** Above, or **▼** Below.
- Press **⏏** 6) Display shows **STRD** stored message momentarily and then advances to **DEAD** Deadband.

DEADBAND SUBMENU:

- Press **⏏** 7) Display shows **020.0** Deadband value that can be changed by pressing **▲** or **▼**.
- Press **⏏** 8) Display shows **STRD** stored message momentarily and then advances to **ID** ID Code Menu.



The Dead Band or neutral zone is the number of degrees or counts (if Input Type is Process) around the Setpoint which the Process Variable must pass above or below the Setpoint, before the output changes state.

3.2.10 ID Code Menu

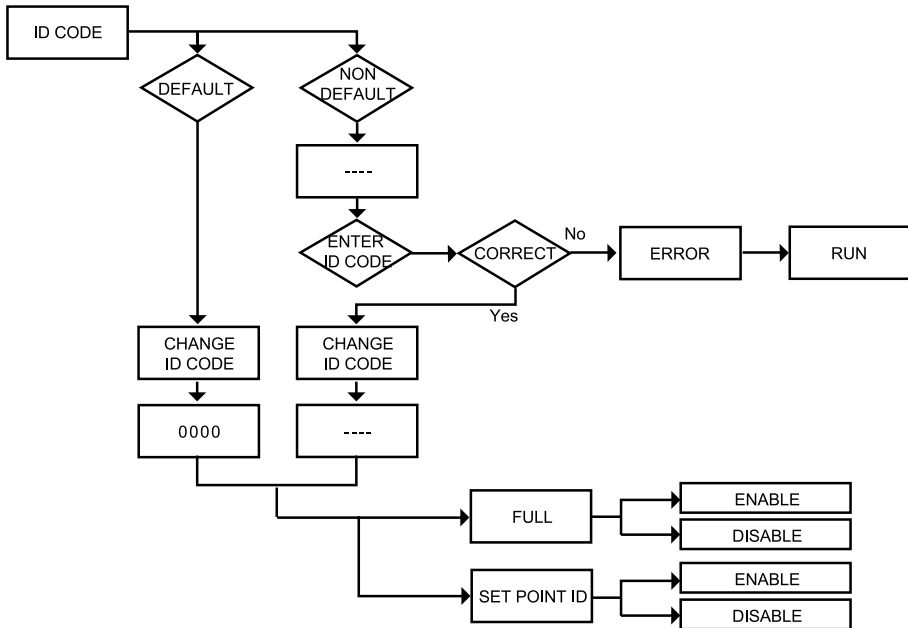

Figure 3.10 Flow Chart for ID Code Menu

ENTER ID CODE MENU:

- Press **⏻** 1) Press **⏻**, if necessary, until **ENFG** prompt appears.
- Press **⏻** 2) Display advances to **INPE** Input Menu.
- Press **⏻** 3) Press **⏻**, if necessary, until display advances to **ID** ID Code Menu.

ENTERING OR CHANGING YOUR (NON-DEFAULT) ID CODE:

- Press **⏻** 4) Display advances to **----** with 1st under score flashing.
- Press **▲** & **▼** 5) Press **▲** and **▼** to enter your 4-digit “ID Code” number.
- Press **⏻** 6) Display advances to **CH.ID** Change ID Code Submenu.





If entered “ID Code” is incorrect display shows **ERR** Error message momentarily and then skips to the Run Mode.

- Press **⏻** 7) Display flashes the first digit of previous entered “ID Code” number.
- Press **▲** & **▼** 8) Press **▲** and **▼** buttons to enter your new “ID Code” number.
- Press **⏻** 9) Display shows **SEEd** stored message momentarily and then advances to the **FULL** Full Security Submenu.

ENTERING OR CHANGING YOUR (DEFAULT) ID CODE:

Enter **ID** menu (Repeat steps from 1 to 3).

- Press  10) Display advances to **CH.ID** Change ID Code Submenu.
Press  11) Display shows **0000** message with flashing 1st digit.



If you want to change your default "ID Code" you can do it now, otherwise press  and menu will skip to **FULL** Full Security Submenu.

- Press  &  12) Press  and  buttons to enter your new "ID Code" number.
Press  13) Display shows **STRD** stored message momentarily and then advances to the **FULL** Full Security Submenu.

FULL SECURITY LEVEL SUBMENU:

- Press  14) Display flashes **ENBL** Enable or **DSBL** Disable.
Press  15) Scroll through the available selections: "Enable" or "Disable".
Press  16) Display shows **STRD** stored message momentarily and then advances to **SP.ID** Setpoint/ID Submenu.



If "Full" Security Level is "Enabled" and the user attempts to enter the Main Menu, they will be prompted for an ID Code. The ID Code should be correct to enter the instrument Menu item.

SETPOINT/ID SECURITY LEVEL SUBMENU:



This Security Level can be functional only if **FULL** Security Level is Disabled.

- Press  17) Display flashes **ENBL** Enable or **DSBL** Disable.
Press  18) Scroll through the available selections: "Enable" or "Disable".
Press  19) Display shows **STRD** stored message momentarily and then advances to **COMM** Communication Submenu.



If "**Setpoint/ID**" Security Level is "**Enabled**" and the user attempts to advance into the **CONF** Configuration Menu, he will be prompted for ID Code number. The ID Code should be correct to proceed into the Configuration Menu, otherwise display will show an Error and skip to the Run Mode.



If "**Full**" and "**Setpoint/ID**" Security Levels are "**Disabled**", the ID code will be "Disabled" and user will not be asked for ID Code to enter the Menu items ("ID" Submenu will not show up in "ID/Setpoint" Menu).

3.2.11 Communication Option Menu

Purchasing this unit with Serial Communications permits an instrument to be configured or monitored from an IBM PC compatible computer using software available at **the website listed on the cover page of this manual or on the CD-ROM enclosed with your shipment**. For complete instructions on the use of the Communications Option, refer to the Serial Communications Reference Manual.

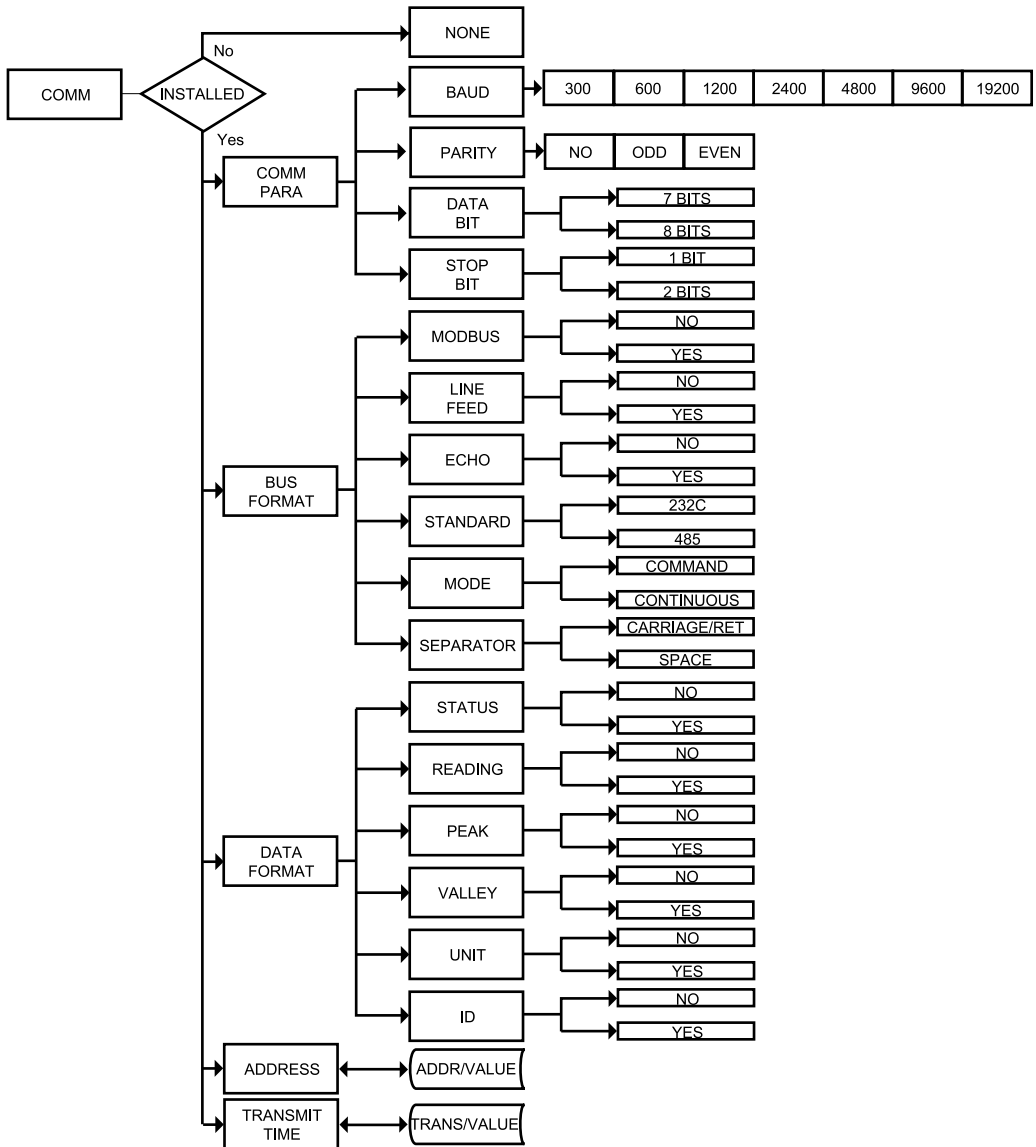







Figure 3.11 Flow Chart for Communication Option Menu

ENTER COMMUNICATION OPTION MENU:

- Press  1) Press , if necessary, until **CONF** prompt appears.
- Press  2) Display advances to **INPE** Input Menu.
- Press  3) Press , if necessary, until display advances to **COMM** Communication Options Menu.
- Press  4) Display advances to **C.PAR** Communication Parameters Submenu.

Note





If Communication Option is not installed, the display shows **NONE** and skips to the Color Display Menu.

COMMUNICATION PARAMETERS SUBMENU:





Allows the user to adjust Serial Communications Settings of the instrument. When connecting an instrument to a computer or other device, the Communications Parameters must match. Generally the default settings (as shown in Section 5) should be utilized.

- Press  5) Display advances to **BAUD** Baud Submenu.





BAUD SUBMENU:

- Press  6) Display flashes previous selection for **BAUD** value.
- Press  7) Scroll through the available selections: **300**, **600**, **1200**, **2400**, **4800**, **9600**, **19.2K**.
- Press  8) Display shows **SEEd** stored message momentarily and then advances to **PREY** only, if it was changed, otherwise press  to advance to **PREY** Parity Submenu.





PARITY SUBMENU:

- Press  9) Display flashes previous selection for "Parity".
- Press  10) Scroll through the available selections: **NO**, **Odd**, **EVEN**.
- Press  11) Display shows **SEEd** stored message momentarily and then advances to **DATA** only, if it was changed, otherwise press  to advance to **DATA** Data Bit Submenu.

DATA BIT SUBMENU:

- Press  12) Display flashes previous selection for "Data Bit".
- Press  13) Scroll through the available selections: **7b 1E**, **8b 1E**.
- Press  14) Display shows **SEEd** stored message and then advances to **SEOP** only, if it was changed, otherwise press  to advance to **SEOP** Stop Bit Submenu.

STOP BIT SUBMENU:





- Press  15) Display flashes previous selection for “Stop Bit”.
- Press  16) Scroll through the available selections: **1b 1E**, **2b 1E**.
- Press  17) Display shows **SERd** stored message momentarily and then advances to **bUS.F** only, if it was changed, otherwise press  to advance to **bUS.F** Bus Format Submenu.

BUS FORMAT SUBMENU:

Determines Communications Standards and Command/Data Formats for transferring information into and out of the unit via the Serial Communications Bus. Bus Format Submenus essentially determine how and when data can be accessed via the Serial Communications of the device.

- Press  18) Display advances to **m.bUS** Modbus Submenu.

MODBUS PROTOCOL SUBMENU:





- Press  19) Display flashes previous selection for **m.bUS**.
- Press  20) Scroll through the available selections: **NO**, **YES**.
- Press  21) Display shows **SERd** stored message momentarily and then advances to **L.F.** only, if it was changed, otherwise press  to advance to **L.F.** Line Feed Submenu.

 **Note** To select iSeries Protocol, set Modbus Submenu to “No”.
To select Modbus Protocol, set Modbus Submenu to “Yes”.

 **Note** If Modbus Protocol was selected, the following Communications Parameters must be set as: No Parity, 8-bit Data Bit, 1-Stop Bit. Do not attempt to change these parameters.

LINE FEED SUBMENU:

Determines if data sent to the instrument will have a Line Feed appended to the end - useful for viewing or logging results on separate lines when displayed on communications software at a computer.

- Press  22) Display flashes previous selection for “Line Feed”.
- Press  23) Scroll through the available selections: **NO**, **YES**.
- Press  24) Display shows **SERd** stored message momentarily and then advances to **ECHO** only, if it was changed, otherwise press  to advance to **ECHO** Echo Submenu.

ECHO SUBMENU:

When valid commands are sent to the instrument, this determines whether the command will be echoed to the Serial Bus. Use of echo is recommended in most situations, especially to help verify that data was received and recognized by the monitor.

- Press **↻** 25) Display flashes previous selection for “Echo”.
- Press **▲** 26) Scroll through the available selections: **NO**, **YES**.
- Press **↻** 27) Display flashes **SEEd** stored message momentarily and then advances to **SEEd** only, if it was changed, otherwise press **↻** to advance to **SEEd** Communication Standard Submenu.

COMMUNICATION INTERFACE STANDARD SUBMENU:

Determines whether device should be connected to an RS-232C serial port (as is commonly used on IBM PC-compatible computers) or via an RS-485 bus connected through appropriate RS-232/485 converter. When used in RS-485 Mode, the device must be accessed with an appropriate Address Value as selected in the Address Submenu described later.

- Press **↻** 28) Display flashes previous selection for “Standard”.
- Press **▲** 29) Scroll through the available selections: **232C**, **485**.
- Press **↻** 30) Display shows **SEEd** stored message momentarily and then advances to **MODE** only, if it was changed, otherwise press **↻** to advance to **MODE** Data Flow Mode Submenu.





DATA FLOW MODE SUBMENU:

Determines whether the instrument will wait for commands and data requests from the Serial Bus or whether the instrument will send data automatically and continuously to the Serial Bus. Devices configured for the RS-485 Communications Standard operate properly only under Command Mode.

- Press **↻** 31) Display flashes previous selection for “Mode”.
- Press **▲** 32) Scroll through the available selections: **Cmd**, “Command”, **CONT** “Continuous”.
- Press **↻** 33) Display shows **SEEd** stored message momentarily and then advances to **SEPR** only, if it was changed, otherwise press **↻** to advance to **SEPR** Data Separation Submenu.

DATA SEPARATION CHARACTER SUBMENU:

Determines whether data sent from the device in Continuous Data Flow Mode will be separated by spaces or by Carriage Returns.

- Press  34) Display flashes previous selection for “Separation” Submenu.
- Press  35) Scroll through the available selections: **SPACE** “Space” or **_CR_** “Carriage Return”.
- Press  36) Display shows **SETRd** stored message momentarily and then advances to **DATE.F** only, if it was changed, otherwise press  to advance to **DATE.F** Data Format Submenu.

DATA FORMAT SUBMENU:





Preformatted data can be sent automatically or upon request from the unit. Use the Data Format Submenus to determine what data will be sent in this preformatted data string. Refer to the iSeries Communications Manual for more information about the data format. At least one of the following suboptions must be enabled and hence output data to the Serial Bus.

Note  This menu is applicable for Continuous Mode of RS-232 communication.

- Press  37) Display advances to **SEAL** Alarm Status Submenu.





ALARM STATUS SUBMENU:

Includes Alarm Status bytes in the data string.

- Press  38) Display flashes previous selection for “Status” (alarm status).
- Press  39) Scroll through the available selections: **NO**, **YES**.
- Press  40) Display shows **SETRd** stored message momentarily and then advances to **RdNG** only, if it was changed, otherwise press  to advance to **RdNG** Reading Submenu.





MAIN READING SUBMENU:

Includes Main Reading in the data string.

- Press  41) Display flashes previous selection for “Reading”.
- Press  42) Scroll through the available selections: **NO**, **YES**.
- Press  43) Display shows **SETRd** stored message momentarily and then advances to **PEAR** only, if it was changed, otherwise press  to advance to **PEAR** Peak Submenu.





PEAK VALUE SUBMENU:

Includes Peak Value in the data string.

- Press  44) Display flashes previous selection for **PEAK** Submenu.
- Press  45) Scroll through the available selections: **NO**, **YES**.
- Press  46) Display shows **SERd** stored message momentarily and then advances to **VALY** only, if it was changed, otherwise press  to advance to **VALY** Valley Submenu.





VALLEY VALUE SUBMENU:

Includes Valley Value in the data string.

- Press  47) Display flashes previous selection for “Valley”.
- Press  48) Scroll through the available selections: **NO**, **YES**.
- Press  49) Display shows **SERd** stored message momentarily and then advances to **UNTE** only, if it was changed, otherwise press  to advance to **UNTE** Temperature Unit Submenu.

TEMPERATURE UNIT SUBMENU:

Includes a byte in the data string to indicate whether reading is in Celsius or Fahrenheit.







- Press  50) Display flashes previous selection for **UNTE**.
- Press  51) Scroll through the available selections: **NO**, **YES**.
- Press  52) Display shows **SERd** stored message momentarily and then advances to **ADDR** only, if it was changed, otherwise press  to advance to **ADDR** Address Setup Submenu.

ADDRESS SETUP SUBMENU:

 **Note** This menu is applicable to the RS-485 Option only.

- Press  53) Display advances to “Address Value” (0000 to 0199) Submenu.

ADDRESS VALUE SUBMENU:

- Press  54) Display flashes 1st digit of previously stored Address Value.
- Press  &  55) Press  and  to enter new “Address Value”.
- Press  56) Display shows **SERd** stored message momentarily and then advances to **TRTM** only, if it was changed, otherwise press  to advance to **TRTM** Transmit Time Interval Submenu.

TRANSMIT TIME INTERVAL SUBMENU:



This menu is applicable if “Continuous” Mode was selected in the “Data Flow Mode” Submenu and the device is configured as an RS-232C Standard device. Also, one or more options under the Data Format Submenu must be enabled.

Press 57) Display advances to **T.R.T.M** “Transmit Time Value” Submenu.

TRANSMIT TIME INTERVAL VALUE SUBMENU:

Determines the interval at which data will be emitted to the RS-232 Serial Bus when the instrument is in Continuous Data Flow Mode.

Press 58) Display flashes 1st digit of previous “Transmit Time Value” in seconds.

Press & 59) Press and to enter new “Transmit Time Value”, e.g. 0030 will send the data every 30 seconds in Continuous Mode.

Press 60) Display shows **5.T.R.d** stored message momentarily and then advances to **COLR** only, if it was changed, otherwise press to advance to **COLR** Color Display Selection Menu.



For more details, refer to the **Communication Manual** available at the website listed on the cover page of this manual or on the CD-ROM enclosed with your shipment.

3.2.12 Display Color Selection Menu

This submenu allows the user to select the color of the display.

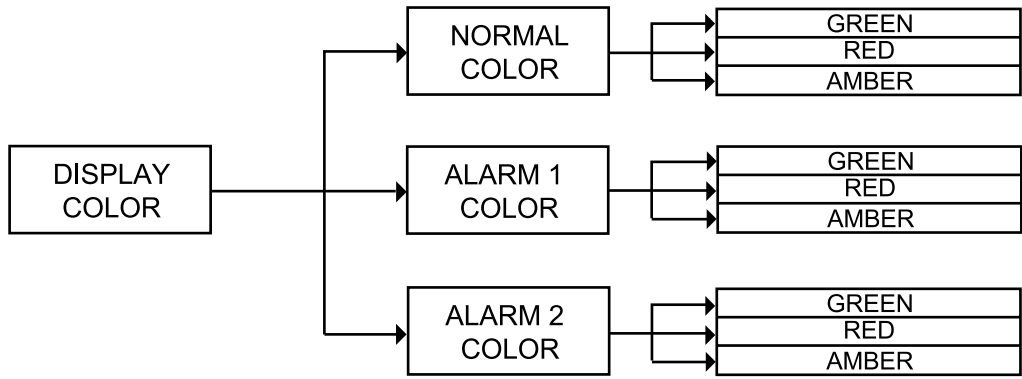

Figure 3.12 Flow Chart for Display Color Selection Menu

ENTER DISPLAY COLOR SELECTION MENU:

- Press **⏪** 1) Press **⏪**, if necessary, until **CONF** prompt appears.
- Press **⏩** 2) Display advances to **INPE** Input Menu.
- Press **⏪** 3) Press **⏪**, if necessary, until display advances to **COLOR** Display Color Selection Menu.
- Press **⏩** 4) Display advances to **N.CLR** Normal Color Submenu.

NORMAL COLOR DISPLAY SUBMENU:



- Press **⏪** 5) Display flashes the previous selection for "Normal Color".
- Press **⏩** 6) Scroll through the available selections: **GRN**, **RED** or **AMBR**.
- Press **⏪** 7) Display shows **SEEd** stored message momentarily and then advances to **1.CLR** only, if it was changed, otherwise press **⏪** to advance to **1.CLR** Alarm 1 Display Color Submenu.

The menu below allows the user to change the color of display when alarm is triggered.

ALARM 1 DISPLAY COLOR SUBMENU:

- Press **⏪** 8) Display flashes previous selection for "Alarm 1 Color Display".
- Press **⏩** 9) Scroll through the available selections: **GRN**, **RED** or **AMBR**.
- Press **⏪** 10) Display shows **SEEd** stored message momentarily and then advances to **2.CLR** only, if it was changed, otherwise press **⏪** to advance to **2.CLR** Alarm 2 Display Color Submenu.

ALARM 2 DISPLAY COLOR SUBMENU:

- Press  11) Display flashes previous selection for "Alarm 2 Color Display".
- Press  12) Scroll through the available selections: **GRN**, **RED** or **AMBR**.
- Press  13) Display shows **SEtRd** stored message momentarily and then momentarily shows the software version number, followed by **RSE** Reset, and then proceeds to the Run Mode.

Tip IN ORDER TO DISPLAY ONE COLOR, SET THE SAME DISPLAY COLOR ON ALL THREE SUBMENUS ABOVE.

Note If user wants the display to change color every time that both Alarm1(SP1) and Alarm2(SP2) are triggered, the Alarm values should be set in such a way that Alarm1(SP1) value is always on the top of Alarm2(SP2) value, otherwise value of Alarm1(SP1) will overwrite value of Alarm2(SP2) and Display Color would not change when Alarm2(SP2) is triggered.

Example 1:

Alarm Setup: Above, SP2 Value = 200, SP1 Value = 400
"Color Display" Setup: Normal Color "N.CLR" = Green,
 Alarm 1 Color "1.CLR" = Amber, Alarm 2 Color "2.CLR" = Red

Display Colors change sequences:



Example 2:

Alarm Setup: Below, SP2 Value = 300, SP1 Value = 100
Color Display Setup: "N.CLR" = Green, "1.CLR" = Amber, "2.CLR" = Red

Display Colors change sequences:

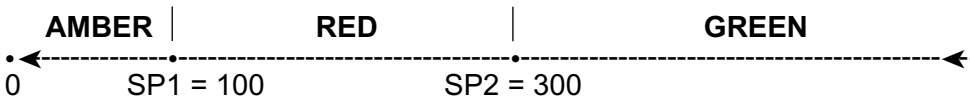

PART 4 SPECIFICATIONS

Accuracy

±0.5°C temp; 0.03% reading process

Resolution

1°/0.1°; 10 µV process

Temperature Stability

- 1) RTD: 0.04°C/°C
 - 2) TC @ 25°C (77°F): 0.05°C/°C
- Cold Junction Compensation
- 3) Process: 50 ppm/°C

NMRR

60 dB

CMRR

120 dB

A/D Conversion

Dual slope

Reading Rate

3 samples per second

Digital Filter

Programmable

Display

Single 4-digit, 9-segment LED,
• 10.2 mm (0.40")(i/16, i/32 model),
• 21 mm (0.83")(i/8 model);
red, green and amber programmable
colors for process variable, setpoint
and temperature units

Warm up to Rated Accuracy

30 min.

INPUT

Input Types

Thermocouple, RTD, Analog Voltage,
Analog Current

Thermocouple Type (ITS 90)

J, K, T, E, R, S, B, C, N, L

Thermocouple Lead Resistance

100 ohm max

RTD Input (ITS 68)

100/500/1000 Ω Pt sensor, 2-, 3- or
4-wire; 0.00385 or 0.00392 curve

Voltage Input

0 to 100 mV, 0 to 1 V, 0 to 10 Vdc

Input Impedance

10 MΩ for 100 mV
1 MΩ for 1 or 10 Vdc

Current Input

0 to 20 mA (5 ohm load)

Configuration

Single-ended

Polarity

Unipolar

Step Response

0.7 sec for 99.9%

Decimal Selection

None, 0.1 for temperature
None, 0.1, 0.01 or 0.001 for process

Setpoint Adjustment

-1999 to 9999 counts

Span Adjustment

0.001 to 9999 counts

Offset Adjustment

-1999 to +9999

NETWORK AND COMMUNICATIONS (Optional -C24, -C4EI, -EI)

Ethernet: Standards Compliance
IEEE 802.3 10Base-T

Supported Protocols: TCP/IP, ARP,
HTTPGET

RS-232/RS-422/RS-485/MODBUS:

Selectable from menu; both ASCII and
modbus protocol selectable from
menu. Programmable 300 to 19.2 K
baud; complete programmable setup
capability; program to transmit current
display, alarm status, min/max, actual
measured input value and status.

RS-485: Addressable from 0 to 199

Connection: Screw terminals

ALARM 1 & 2

Programmable to display color change

Relay 250 Vac or 30 Vdc @ 3 A
(Resistive Load); configurable for on/off,
PID and Ramp and Soak

Output 1: SPDT type, can be configured
as Alarm 1 output

Output 2: SPDT type, can be configured
as Alarm 2 output

SSR 20-265 Vac @ 0.05-0.5 A
(Resistive Load); continuous

DC Pulse Non-Isolated; 10 Vdc @ 20 mA

Analog Output (Output 1 only)
Non-Isolated, Proportional 0 to 10 Vdc
or 0 to 20 mA; 500 Ω max

Operation High/low, above/below, band,
latch/unlatch, normally open/normally
closed and process/deviation; front panel
configurations

ANALOG OUTPUT (programmable)

Non-Isolated, Retransmission 0 to 10
Vdc or 0 to 20 mA, 500 Ω max (Output
1 only). Accuracy is $\pm 1\%$ of FS when
following conditions are satisfied.

- 1) Input is not scaled below 1% of
Input FS.
- 2) Analog Output is not scaled below
3% of Output FS.

EXCITATION

(optional in place of Communication)

24 Vdc @ 25 mA

Not available for Low Power Option

INSULATION

Power to Input/Output

2300 Vac per 1 min. test

1500 Vac per 1 min. test

(Low Voltage/Power Option)

Power to Relays/SSR Outputs

2300 Vac per 1 min. test

Relays/SSR to Relay/SSR Outputs

2300 Vac per 1 min. test

RS-232/485 to Inputs/Outputs

500 Vac per 1 min. test

Approvals see CE Approval Section

Protection Type 4 / NEMA-4x (IP65)
front bezel

GENERAL

Line Voltage/Power

90-240 Vac +/-10%, 50-400 Hz*

110-375 Vdc, equivalent voltage

4 W, power for i8, i8C, i16, i32 Models

5 W, power for i8DV, i8DH, i16D Models

* No CE compliance above 60 Hz

Low Voltage/Power Option

12-36 Vdc, **3 W****, power for i8, i16, i32

20-36 Vdc, **4 W****, power for i8DV, i8DH, i16D

External power source must meet Safety
Agency Approvals.

** Units can be powered safely with 24 Vac power
but, no Certification for CE/UL are claimed.

External Fuse Required

Time-Delay, UL 248-14 listed:

100 mA/250 V

400 mA/250 V (Low Voltage/Power Option)

Time-Lag, IEC 127-3 recognized:

100 mA/250 V

400 mA/250 V (Low Voltage/Power Option)

Environmental Conditions

All models: 0 to 55°C (32 to 131°F),

90% RH non-condensing

i8C: 0 to 50°C (32 to 122°F) for UL only.

90% RH non-condensing

Dimensions

i/8 Series: 48 H x 96 W x 127 mm D
(1.89 x 3.78 x 5")

i/8 Compact Series: 48H x 96W x 74mm D
(1.89 x 3.78 x 2.91")

i/16 Series: 48 H x 48 W x 127 mm D
(1.89 x 1.89 x 5")

i/32 Series: 25.4 H x 48 W x 127 mm D
(1.0 x 1.89 x 5")

Panel Cutout

i/8 Series: 1/8 DIN

45 H x 92 mm W (1.772" x 3.622"),

i/16 Series: 1/16 DIN

45 mm (1.772") square

i/32 Series: 1/32 DIN

22.5 H x 45 mm W (0.886" x 1.772")

Weight

i/8 Series: 295 g (0.65 lb)

i/16 Series: 159 g (0.35 lb)

i/32 Series: 127 g (0.28 lb)

Table 4.1 Input Properties

TC	Input Type	Range	Accuracy*
J	Iron-Constantan	-210 to 760°C -346 to 1400°F	0.4°C 0.7°F
K	CHROMEGA®- ALOMEGA®	-270 to -160°C -160 to 1372°C -454 to -256°F -256 to 2502°F	1.0°C 0.4°C 1.8°F 0.7°F
T	Copper-Constantan	-270 to -190°C -190 to 400°C -454 to -310°F -310 to 752°F	1.0°C 0.4°C 1.8°F 0.7°F
E	CHROMEGA- Constantan	-270 to -220°C -220 to 1000°C -454 to -364°F -364 to 1832°F	1.0°C 0.4°C 1.8°F 0.7°F
R	Pt/13%Rh-Pt	-50 to 40°C 40 to 1788°C -58 to 104°F 104 to 3250°F	1.0°C 0.5°C 1.8°F 0.9°F
S	Pt/10%Rh-Pt	-50 to 100°C 100 to 1768°C -58 to 212°F 212 to 3214°F	1.0°C 0.5°C 1.8°F 0.9°F
B	30%Rh-Pt/ 6%Rh-Pt	200 to 640°C 640 to 1820°C 212 to 1184°F 1184 to 3308°F	1.0°C 0.5°C 1.8°F 0.9°F
C	5%Re-W/ 26%Re-W	0 to 2354°C 32 to 4253°F	0.4°C 0.7°F
N	Nicrosil-Nisil	-250 to -100°C -100 to 1300°C -418 to -148°F -148 to 2372°F	1.0°C 0.4°C 1.8°F 0.7°F
L	J DIN	-200 to 900°C -328 to 1652°F	0.4°C 0.7°F
RTD	Pt, 0.00385, 100 Ω, 500 Ω, 1000 Ω	200 to 900°C -328 to 1652°F	0.4°C 0.7°F
RTD	Pt, 0.00392, 100 Ω, 500 Ω, 1000 Ω	-200 to 850°C -328 to 1562°F	0.4°C 0.7°F
PROCESS	Voltage	0 to 100 mV, 0 to 1 V, 0 to 10 Vdc	0.03% rdg 0.03% rdg
PROCESS	Current	0 to 20 mA, 4 to 20 mA	0.03% rdg

PART 5

FACTORY PRESET VALUES

Table 5.1 Factory Preset Values

MENU ITEMS	FACTORY PRESET VALUES	NOTES
Set Point 1 (SP1)	000.0	
Set Point 2 (SP2)	000.0	
Input:		
Input Type (INPt)	TC, type K	
Reading Configuration (RDG):		
Decimal Point (dEC.P)	FFF.F	
Temperature unit (TEMP)	°F	
Filter value (FLtR)	0004	
Reading Adjust Value (R.AdJ)	000.0	
SePOINT Deviation (SP.dV)	Disabled	
Alarm 1 & 2:		
Latch (LtCH)	Disable (dSbL)	Alarm 1 only
Active (ACTV)	Above (AbOV)	
Deadband (dEAd)	020.0	
ID:		
ID Value	0000	
Full ID (FULL)	Disable (dSbL)	
Set Point ID (Id.SP)	Disable (dSbL)	
Communication Parameters:		
Baud Rate (bAUd)	9600	
Parity (PRtY)	Odd	
Data bit (dAtA)	7 bit	
Stop Bit	1 bit	
Modbus Protocol (M.bUS)	No	
Line Feed (LF)	No	
Echo (ECHO)	Yes	
Standard Interface (StNd)	RS232 (232C)	
Command Mode (MOdE)	Command (CMd)	
Separation (SEPR)	Space (SPCE)	
Alarm Status (StAt)	No	
Reading (RdNG)	Yes	
Peak	No	
Valley (VALY)	No	
Units (UNIt)	No	
Multipoint Address (AddR)	0001	
Transmit Time (tR.tM)	0016	
Display Color (COLR):		
Normal Color (N.CLR)	Green (GRN)	
Alarm 1 Color (1.CLR)	Red (RED)	
Alarm 2 Color (2.CLR)	Amber (AMbR)	

PART 6 CE APPROVALS INFORMATION

 This product conforms to the EMC directive 89/336/EEC amended by 93/68/EEC, and with the European Low Voltage Directive 72/23/EEC.

Electrical Safety EN61010-1:2001

Safety requirements for electrical equipment for measurement, control and laboratory.

Double Insulation

Pollution Degree 2

Dielectric withstand Test per 1 min

- Power to Input/Output: 2300Vac (3250Vdc)
- Power to Input/Output: 1500Vac (2120Vdc)
(Low Voltage dc Power Option*)
- Power to Relays/SSR Output: 2300Vac (3250Vdc)
- Ethernet to Inputs: 1500Vac (2120Vdc)
- Isolated RS232 to Inputs: 500Vac (720Vdc)
- Isolated Analog to Inputs: 500Vac (720Vdc)
- Analog/Pulse to Inputs: No Isolation

Measurement Category I

Category I are measurements performed on circuits not directly connected to the Mains Supply (power). Maximum Line-to-Neutral working voltage is 50Vac/dc. This unit should not be used in Measurement Categories II, III, IV.

Transients Overvoltage Surge (1.2 / 50uS pulse)

- Input Power: 2500V
- Input Power: 1500V
(Low Voltage dc Power Option*)
- Ethernet: 1500V
- Input/Output Signals: 500V

Note: *Units configured for external low power dc voltage, 12-36Vdc

EMC EN61326:1997 + and A1:1998 + A2:2001

Immunity and Emissions requirements for electrical equipment for measurement, control and laboratory.

- EMC Emissions Table 4, Class B of EN61326
- EMC Immunity** Table 1 of EN61326

Note: **I/O signal and control lines require shielded cables and these cables must be located on conductive cable trays or in conduits. Furthermore, the length of these cables should not exceed 30 meters



Refer to the EMC and Safety installation considerations (Guidelines) of this manual for additional information.



WARRANTY/DISCLAIMER

OMEGA ENGINEERING, INC. warrants this unit to be free of defects in materials and workmanship for a period of **one (1) year** from the date of purchase. In addition to OMEGA's standard warranty period, OMEGA Engineering will extend the warranty period for **four (4) additional years** if the warranty card enclosed with each instrument is returned to OMEGA.

If the unit malfunctions, it must be returned to the factory for evaluation. OMEGA's Customer Service Department will issue an Authorized Return (AR) number immediately upon phone or written request. Upon examination by OMEGA, if the unit is found to be defective, it will be repaired or replaced at no charge. OMEGA's WARRANTY does not apply to defects resulting from any action of the purchaser, including but not limited to mishandling, improper interfacing, operation outside of design limits, improper repair, or unauthorized modification. This WARRANTY is VOID if the unit shows evidence of having been tampered with or shows evidence of having been damaged as a result of excessive corrosion; or current, heat, moisture or vibration; improper specification; misapplication; misuse or other operating conditions outside of OMEGA's control. Components which wear are not warranted, including but not limited to contact points, fuses, and triacs.

OMEGA is pleased to offer suggestions on the use of its various products. However, OMEGA neither assumes responsibility for any omissions or errors nor assumes liability for any damages that result from the use of its products in accordance with information provided by OMEGA, either verbal or written. OMEGA warrants only that the parts manufactured by it will be as specified and free of defects. OMEGA MAKES NO OTHER WARRANTIES OR REPRESENTATIONS OF ANY KIND WHATSOEVER, EXPRESS OR IMPLIED, EXCEPT THAT OF TITLE, AND ALL IMPLIED WARRANTIES INCLUDING ANY WARRANTY OF MERCHANTABILITY AND FITNESS FOR A PARTICULAR PURPOSE ARE HEREBY DISCLAIMED. LIMITATION OF LIABILITY: The remedies of purchaser set forth herein are exclusive, and the total liability of OMEGA with respect to this order, whether based on contract, warranty, negligence, indemnification, strict liability or otherwise, shall not exceed the purchase price of the component upon which liability is based. In no event shall OMEGA be liable for consequential, incidental or special damages.

CONDITIONS: Equipment sold by OMEGA is not intended to be used, nor shall it be used: (1) as a "Basic Component" under 10 CFR 21 (NRC), used in or with any nuclear installation or activity; or (2) in medical applications or used on humans. Should any Product(s) be used in or with any nuclear installation or activity, medical application, used on humans, or misused in any way, OMEGA assumes no responsibility as set forth in our basic WARRANTY/DISCLAIMER language, and, additionally, purchaser will indemnify OMEGA and hold OMEGA harmless from any liability or damage whatsoever arising out of the use of the Product(s) in such a manner.

RETURN REQUESTS/INQUIRIES

Direct all warranty and repair requests/inquiries to the OMEGA Customer Service Department. BEFORE RETURNING ANY PRODUCT(S) TO OMEGA, PURCHASER MUST OBTAIN AN AUTHORIZED RETURN (AR) NUMBER FROM OMEGA'S CUSTOMER SERVICE DEPARTMENT (IN ORDER TO AVOID PROCESSING DELAYS). The assigned AR number should then be marked on the outside of the return package and on any correspondence.

The purchaser is responsible for shipping charges, freight, insurance and proper packaging to prevent breakage in transit.

FOR WARRANTY RETURNS, please have the following information available BEFORE contacting OMEGA:

1. Purchase Order number under which the product was PURCHASED,
2. Model and serial number of the product under warranty, and
3. Repair instructions and/or specific problems relative to the product.

FOR NON-WARRANTY REPAIRS, consult OMEGA for current repair charges. Have the following information available BEFORE contacting OMEGA:

1. Purchase Order number to cover the COST of the repair,
2. Model and serial number of product, and
3. Repair instructions and/or specific problems relative to the product.

OMEGA's policy is to make running changes, not model changes, whenever an improvement is possible. This affords our customers the latest in technology and engineering.

© Copyright 2005 OMEGA ENGINEERING, INC. All rights reserved. This document may not be copied, photocopied, reproduced, translated, or reduced to any electronic medium or machine-readable form, in whole or in part, without the prior written consent of OMEGA ENGINEERING, INC.

TRADEMARK NOTICE: ®, *omega.com*®,  **OMEGA**®, and  are Trademarks of OMEGA ENGINEERING, INC.

PATENT NOTICE: This product is covered by one or more of the following patents: U.S. Pat. No. Des. 336,895; 5,274,577; 6,243,021 / CANADA 2052599; 2052600 / ITALY 1249456; 1250938 / FRANCE BREVET No. 91 12756 / SPAIN 2039150; 2048066 / UK PATENT No. GB2 249 837; GB2 248 954 / GERMANY DE 41 34398 C2. The "Meter Bezel Design" is a Trademark of NEWPORT Electronics, Inc. Used under License. Other US and International Patents pending or applied for.

Where Do I Find Everything I Need for Process Measurement and Control? **OMEGA...Of Course!**

Shop on line at www.omega.com

TEMPERATURE

- Thermocouple, RTD & Thermistor Probes, Connectors, Panels & Assemblies
- Wire: Thermocouple, RTD & Thermistor
- Calibrators & Ice Point References
- Recorders, Controllers & Process Monitors
- Infrared Pyrometers

PRESSURE, STRAIN AND FORCE

- Transducers & Strain Gauges
- Load Cells & Pressure Gauges
- Displacement Transducers
- Instrumentation & Accessories

FLOW/LEVEL

- Rotameters, Gas Mass Flowmeters & Flow Computers
- Air Velocity Indicators
- Turbine/Paddlewheel Systems
- Totalizers & Batch Controllers

pH/CONDUCTIVITY

- pH Electrodes, Testers & Accessories
- Benchtop/Laboratory Meters
- Controllers, Calibrators, Simulators & Pumps
- Industrial pH & Conductivity Equipment

DATA ACQUISITION

- Data Acquisition & Engineering Software
- Communications-Based Acquisition Systems
- Plug-in Cards for Apple, IBM & Compatibles
- Datalogging Systems
- Recorders, Printers & Plotters

HEATERS

- Heating Cable
- Cartridge & Strip Heaters
- Immersion & Band Heaters
- Flexible Heaters
- Laboratory Heaters

ENVIRONMENTAL MONITORING AND CONTROL

- Metering & Control Instrumentation
- Refractometers
- Pumps & Tubing
- Air, Soil & Water Monitors
- Industrial Water & Wastewater Treatment
- pH, Conductivity & Dissolved Oxygen Instruments