

1 YEAR
WARRANTY



Ω OMEGA® **User's Guide**

*Shop online at
omega.comSM*

*e-mail: info@omega.com
For latest product manuals:
www.omegamanual.info*

DPU91 SERIES **Transmitter**



omega.com info@omega.com

Servicing North America:

**U.S.A.
Headquarters:**

Omega Engineering, Inc.

Toll-Free: 1-800-826-6342 (USA & Canada only)

Customer Service: 1-800-622-2378 (USA & Canada only)

Engineering Service: 1-800-872-9436 (USA & Canada only)

Tel: (203) 359-1660

Fax: (203) 359-7700

e-mail: info@omega.com

For Other Locations Visit omega.com/worldwide

1. Quick Start

Your new Omega DPU91 Transmitter needs to be calibrated and the sensor needs to be initialized prior to use. The following steps outline the recommended procedure to start up a new system.

1. **Module Installation (pg. 7)**
 2. **Installation (pg. 18)**
 3. **Wiring (pg. 20)**
 4. **Sensor Wiring (pg. 23)**
 5. **Power Wiring (pg. 26)**
 6. **Open Collector Wiring (pg. 27)**
 7. **Relay Module Wiring (pg. 28)**
 8. **Relay Functions (pg. 28)**
 9. **Operation (pg. 34)**
 10. **Menu System (pg. 36)**
-

2. Description

The DPU91 Transmitter, a member of Omega's line of instruments, provides a single-channel interface for all Flow, pH/ORP, Conductivity/Resistivity, Salinity, and Batch.

The DPU91 is available in either Panel or Field Mount.

Both versions run on 10.8 to 35.2 VDC power (24 VDC nominal), and can power certain sensors on loop power (see NOTE below).

3. Compatibility

The DPU91 is compatible with all Omega products listed in the column to the right.

- pH and ORP electrodes require the Omega PHTX-275 (ISO) or PHTX-275G (ISO) Sensor Electronics (sold separately).
- Conductivity/Resistivity or Salinity measurement requires either the optional DPU90-C Direct Conductivity/Resistivity Module or the CDTX-285X Series Conductivity/Resistivity Sensor Electronics (both sold separately).

Flow

FP-5300*, FP-5600*, FP-8500*, FP-5200*, FP-5070, FP-5060, FPB, P-2540*, FP-3-1500*, FMG-3000, FMG-550

pH/ORP

PHE-2724, PHE-2726, ORE-2725 with PHTX-275 (ISO) or PHTX-275G (ISO)*

Conductivity/Resistivity, Salinity

CDCE-90 with CDTX-285X or DPU90-C Conductivity/Resistivity Module
CDE-285X with CDTX-285X or DPU90-C Conductivity/Resistivity Module

* Can be run on Loop Power; all other measurement sensors require DC power.





NOTE:

Loop powered systems cannot power both DPU90-COMM and pH sensors on one system.

If using both DPU90-COMM Module and pH sensors, DC power is required.

4. Safety Information

- Follow instructions carefully to avoid personal injury.
- This unit is designed to be connected to equipment which can be hazardous to persons and property if used incorrectly.
- Read and understand all associated equipment manuals and safety warnings before using with this product.
- Remove power to unit before wiring connections.
- Wiring connections to this product should only be performed by qualified personnel.
- Do not use unit if front panel is cracked or broken.

	<p>Warning / Caution / Danger Indicates a potential hazard. Failure to follow all warnings may lead to equipment damage, injury, or death.</p>
	<p>Electrostatic Discharge (ESD) / Electrocutation Danger Alerts user to risk of potential damage to product by ESD, and/or risk of potential of injury or death via electrocution.</p>
	<p>Personal Protective Equipment (PPE) Always utilize the most appropriate PPE during installation and service of Omega products.</p>
	<p>NOTE / Technical Notes Highlights additional information or detailed procedure.</p>



CAUTION

Avoid Electrostatic Discharge (ESD).

- Minimize handling of the plug-in modules to reduce the possibility of damage due to ESD.
- Handle modules by the edges.
Never touch any exposed circuitry or contacts.
- Wear an anti-static wristband or stand on an anti-static mat, or keep one hand touching a properly grounded pipe or other piece of properly grounded metal when handling modules.

5. Contents

- 1. Quick Start 3
- 2. Description 3
- 3. Compatibility 3
- 4. Safety Information 4
- 5. Contents 5
- 6. Dimensions 6
- 7. Module Installation 7
- 8. Plug-In Modules 7
- 9. Relay Module 8
- 10. Direct Conductivity/Resistivity Module 9
- 11. Batch Module 10
- 12. DPU90-COMM Module 10
- 13. Installation 18
- 14. Wiring 20
- 15. Signal Type: Frequency 20
- 16. Signal Type: Digital (S³L) 21
- 17. Terminal Identification 22
- 18. Sensor Wiring 23
- 19. Sensor Wiring Technical Notes 25
- 20. Power Wiring 26
- 21. Open Collector Wiring 27
- 22. Relay Module Wiring 28
- 23. Relay Functions 28
- 24. Relay and Open Collector Outputs 29
- 25. Operation 34
- 26. Menu System 36
 - System Setup Menu 36
 - VIEW Mode Overview 37
 - MENU Mode Overview 37
 - Password Overview 38
- 27. Common Menus 39
 - INPUT Menu 39
 - LOOP Menu 39
 - RELAY Menu 40
 - OPTION Menu 42
- 28. Sensor-Specific Menus 43
 - Flow 43
 - pH 45
 - ORP 47
 - Conductivity/Resistivity 49
 - Salinity 51
- 29. Troubleshooting 53
- 30. Appendix 54
 - Averaging 54
 - LOG Current Loop Output 55
 - Calibration Procedure: pH 56
 - Calibration Procedure: ORP 58
 - Calibration Procedure: Conductivity/Resistivity 60
 - Calibration Procedure: Flow 61
 - Calibration Error Messages 62
 - USP Limits 63
- 39. Maintenance 63
- 40. Specifications 64
- 41. Ordering Information 70

6. Dimensions

Panel Mount DPU91P

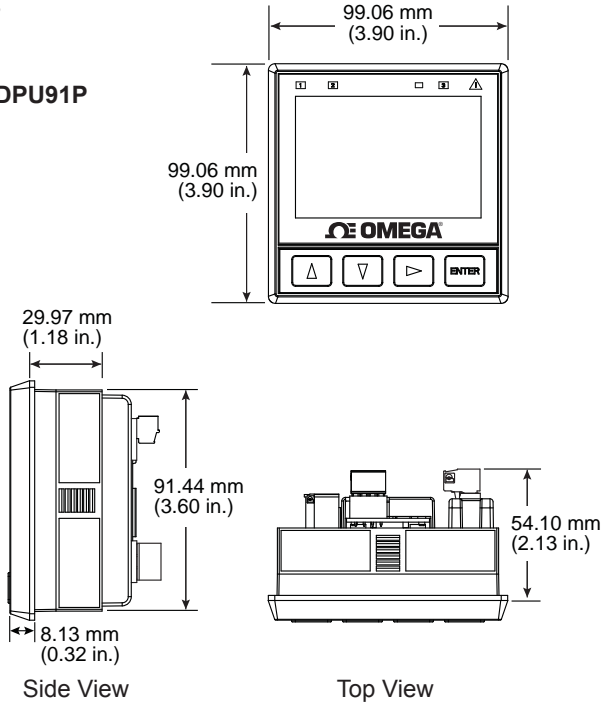

Field Mount DPU91

(FP90IM shown)

NOTE: FP90IM
Integral Mounting Kit
sold separately.

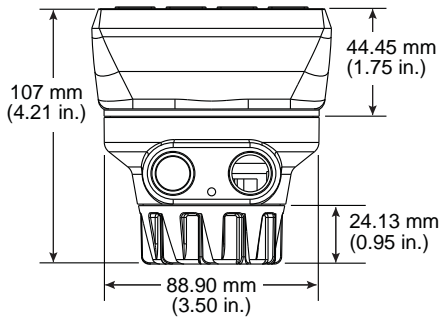

DPU90-AK Angle Adjustment Adapter Kit

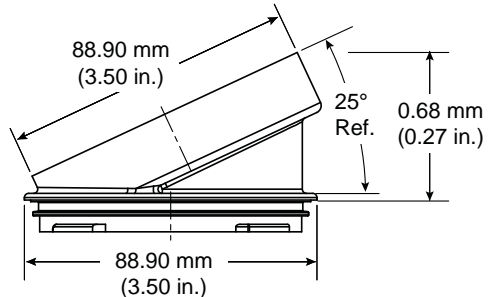

7. Module Installation

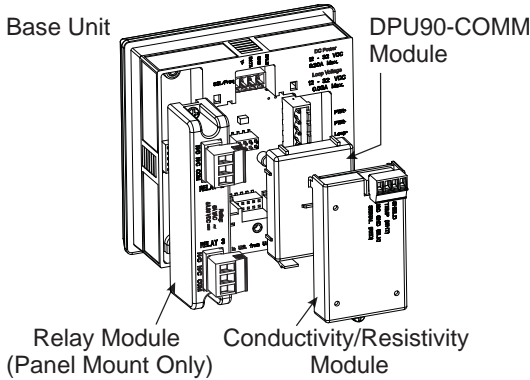

CAUTION

Exercise care when installing modules.

Do not bend connecting pins.

LOOP as well as DC power MUST be removed BEFORE installing DPU90-COMM.

Relays may be connected to external high-voltage power sources or multiple power sources creating an electrocution hazard.

If the DPU91 Base Unit will be mounted in a panel, the plug-in modules may be installed either before or after the base unit is mounted. If the DPU91 Base Unit will be mounted using the accessory wall mount bracket, install plug-in modules first.

If installing both the Conductivity/Resistivity (Cond/Res) and the DPU90-COMM, install the DPU90-COMM first, then the Cond/Res Module on top of it (see page 9).

The Relay, Cond/Res, and Batch Modules attach with screws.

The DPU90-COMM simply plugs in.

To install modules:

Remove power from the DPU91.

Carefully align pins and connectors (do not bend connecting pins) and push module firmly into place, then attach with screw(s) (except DPU90-COMM Module).

To remove modules:

Remove power from the DPU91.

For Relay and Cond/Res Modules, unplug connectors, remove screw(s), and carefully pull module straight out from the base unit. Do not bend the connecting pins.

For DPU90-COMM, squeeze the tabs on the bottom edge, grasp the module and pull straight out. Do not bend the connecting pins.

For Batch Module, remove the Relay module. Loosen bottom screw of Batch module.

Carefully grip and squeeze the tabs at the top of the module to release.

Pull module away from the unit. Do not bend the connecting pins

8. Plug-In Modules

Optional modules and accessories are available for the DPU91:

- Base Unit (required)
- Slot for optional DPU90-COMM Module
- Slot for optional Cond/Res Module or optional Batch Module (DPU91P only)
- Slot for optional Relay Module (not available on field mount)

Each item is ordered separately.

Modules are field-replaceable at any time.

See Installation (pg. 18) and

Ordering Information (pg. 70) sections for more details.

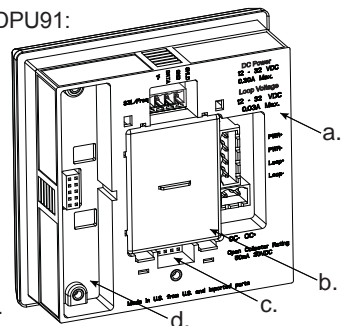

9. Relay Module

(Panel Mount installations only)

Mfr. Part No.	Description
DPU90-R	Relay Module - Two dry-contact relays

In addition to the standard programmable Open Collector output in the base unit, the Panel Mount version of the DPU91 has a slot for an optional Relay Module, which adds two programmable dry-contact relays. The Open Collector output in the base unit uses the Relay 1 setting in the menus. If the optional Relay Module is installed, these are assigned to relays 2 and 3 in the menus.

Dry-contact relays are electromechanical switches with a moving contact armature. They are suitable for many general-purpose applications, AC or DC, including AC loads up to 250 V. Install RC Filter Kits, FP90RC, on relays used to switch motor or inductive loads.

- Two (2) SPDT dry-contact relay (DCR) inputs
- User programmable
- 250 V, 5 A maximum resistive loading (AC).
- Can switch line voltage (typically 120 to 240 VAC)
- Can switch DC voltage (< 30 VDC @ 5A)
- Larger voltage and current ratings than Open Collector outputs.

For wiring information, refer to the Relay Module Wiring section (page 28).

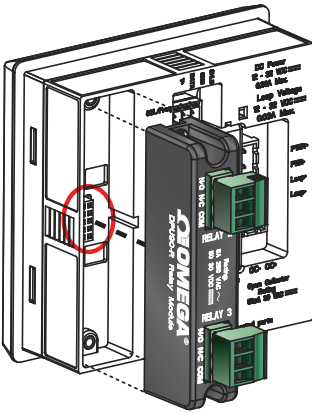

NOTE:

The Relay Module requires 10.8-35.2 VDC, 300 mA power connection to DC PWR Terminals.

The Relay Module cannot be used with loop power.

- The two red Mechanical Relay Indicator LEDs on the front panel of the DPU91 show the status of relays 2 and 3. (Status of all relays and Open Collector is available at all times in a single screen in View mode.)
- Hysteresis and time delay are adjustable for each relay.

CAUTION



DO NOT bundle Relay Module wiring with other wiring. Doing so may cause injury and/or damage to DPU91 Transmitter, Relay Module, and Batch Module.

CAUTION



Switching active loads (usually inductive) can cause contact arcing sufficient to damage the relays. The FP90RC, RC Filter Kit or “snubber” is available as an accessory to reduce or eliminate these damaging effects. Recommended for inductive loads greater than 50 VAC (remote relays, solenoids, pumps, etc.)

10. Direct Conductivity/Resistivity Module

Mfr. Part No.	Description
DPU90-C	Direct Conductivity/Resistivity Module

The Direct Conductivity/Resistivity (Cond/Res) Module interfaces Omega CDCE-90 and CDE-285X Conductivity electrodes directly to the DPU91.

- Provides filtering and conditioning.
- Sensor cable length can be extended to 30 m (100 ft).
- CDE-285X sensors come with a cell constant certificate to improve the accuracy of the sensor measurements (see page 50).

Wiring for the CDCE-90 and CDE-285X Conductivity electrodes to the DPU90-C:

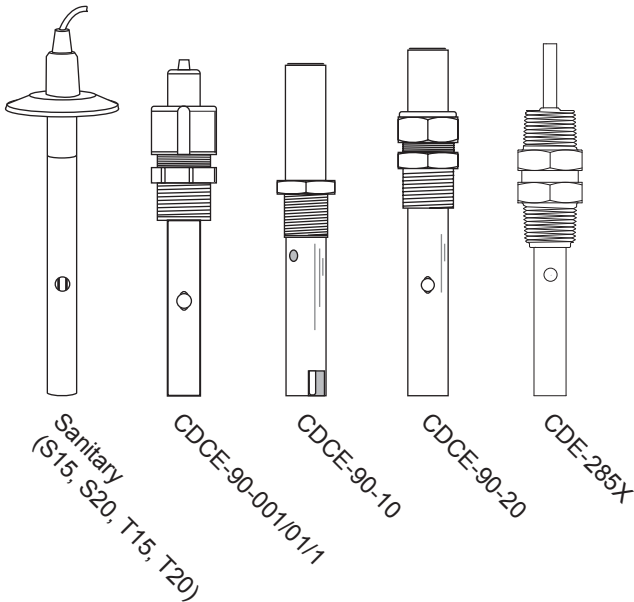
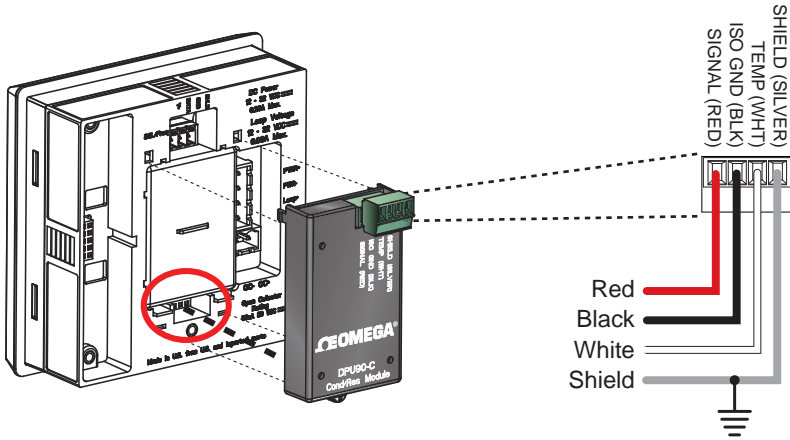

11. Batch Module

Mfr. Part No.	Description
DPU90-BCM	Batch Module

Convert a DPU91P Transmitter (Generation II or later) into a Batch Controller system by utilizing a Batch Module (DPU90-BCM) and a Relay Module (DPU90-R).

Optional Module Wiring:

- Wire an external button or keypad (customer supplied) to stop, start or resume a batch remotely.
- Wire an external input that can inhibit a batch from starting.

Full DPU91-BC Batch Controller System manual available at Omega.com

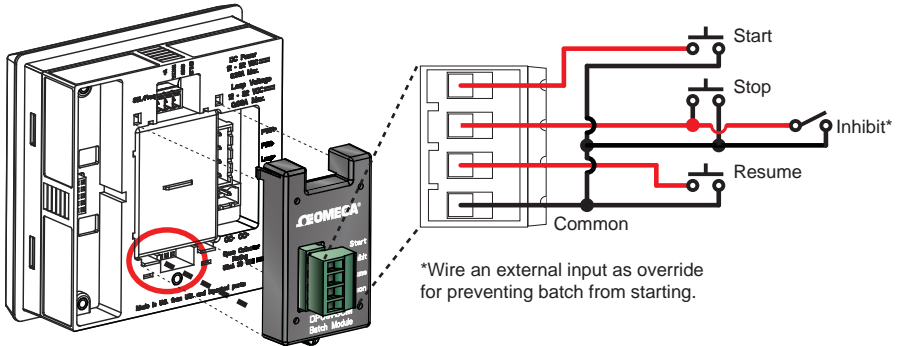

NOTE: The DPU90-BCM is incompatible with the DPU90-C and DPU90-COMM.

12. COMM Module

Mfr. Part No.	Description
DPU90-COMM	COMM Module

The DPU90-COMM Module enables communication between the DPU91 and a HART®-enabled device. The HART (Highway Addressable Remote Transducer) Protocol superimposes digital signals on top of the 4 to 20 mA analog signal.

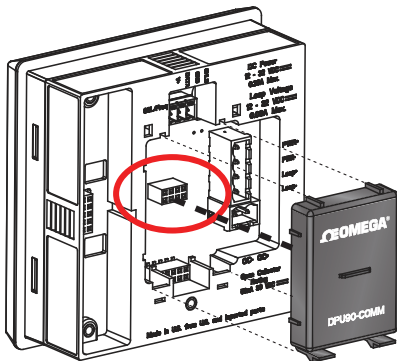

NOTE:

With DPU90-COMM module installed, a minimum of 24 V is required for loop-powered systems.

The black rubber jumper adjacent to the power terminal should only be removed when both the DPU90-COMM Module is utilized and the required sensor cable length is over 304 m (1000 ft).

HART® is a registered trademark of the HART Communication Foundation, Austin, Texas, USA. Any use of the term HART hereafter in this document implies the registered trademark.

How HART® Works

The HART® (Highway Addressable Remote Transducer) Protocol uses Frequency Shift Keying (FSK) to superimpose digital signals on top of the analog 4 to 20 mA current loop. This allows two-way digital communication to occur and allows additional information beyond the normal process data to be communicated to the DPU91.

This digital signal can contain data such as device status, diagnostics, etc.

The HART protocol provides two simultaneous communication channels: a 4 to 20 mA analog signal and a digital signal. The analog signal communicates the primary measured value using the 4 to 20 mA current loop. Additional information is communicated using a digital signal superimposed on the 4 to 20 mA signal.

Communication occurs between two HART-enabled devices, in this application a DPU91 and a PLC or handheld device, using standard wiring and termination practices.

The HART Protocol communicates at 1200 bits per second without interfering with the 4 to 20 mA signal and allows the PLC or handheld device to communicate two or more updates per second to and from the DPU91.

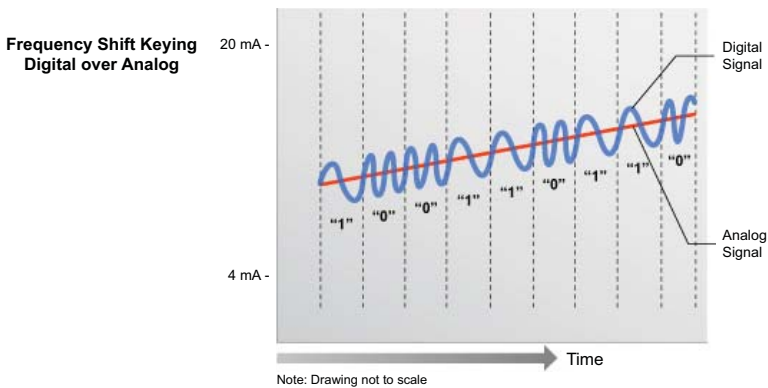

The HART protocol operates according to the master-slave method. Any communication activity is initiated by the master, usually a programmable logic controller (PLC) or a data acquisition system. HART accepts two masters: the primary master - usually the control system (PLC) - and the secondary master - a PC laptop or handheld terminal used in the field.

HART field devices - the slaves - never send without being requested to do so.

They respond only when they have received a command message from the master.

Once a transaction (i.e., a data exchange between the control station and the field device) is complete, the master will pause for a fixed time period before sending another command, allowing the other master to break in. The two masters observe a fixed time frame when taking turns communicating with the slave devices.

As deployed in the DPU91 application, HART allows remote verifying, testing, adjusting and monitoring of primary and secondary device variables.

Features available in the DPU91 Transmitter with DPU90-COMM Module installed:

- **Adjust 4 to 20 mA:** Allows fine-tuning to compensate for errors in other equipment connected to the DPU91. Adjust the minimum and maximum current output.
- **Supports Multi-Drop Mode:** Up to four DPU91 Transmitters can be installed in this mode.
- **Supports all Universal HART Protocol Revision 7.2 commands**
- **Supports many Common Practice Commands**
- **Makes Primary and Secondary values available at PLC.** Secondary values are sensor-dependent and are available with pH, Conductivity, Resistivity, and Salinity sensors.

Connecting HART with a Loop-powered sensor (Typical installation)

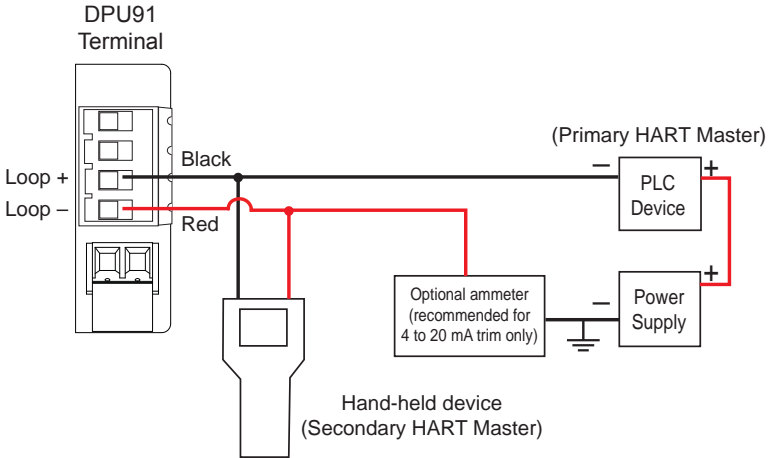

Connecting HART to a Hand-Held Master Device (Typical installation)

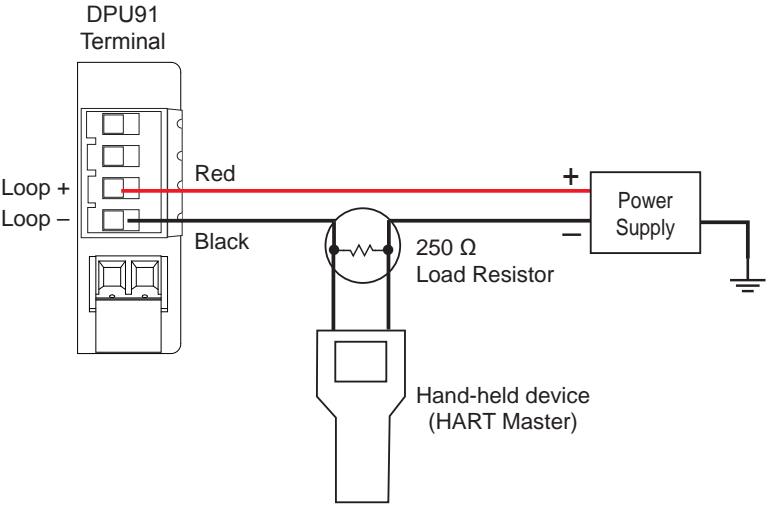

NOTE: From this point forward the term “DPU91 Transmitter” or “Transmitter” will assume the DPU90-COMM Module is installed unless otherwise noted.

Multi-Drop Mode

Up to four DPU91 Transmitters can be connected in Multi-Drop mode using the DPU90-COMM Module.

To ensure proper operation in Multi-Drop mode, configure each DPU91 Transmitter with its own poll address using a configuration tool (laptop or hand-held device).

After configuring the DPU91 Transmitter for multi-drop function, reset the Transmitter (remove power for five seconds then apply power) before use.

Connecting HART in Multi-Drop mode (Typical four-unit installation)

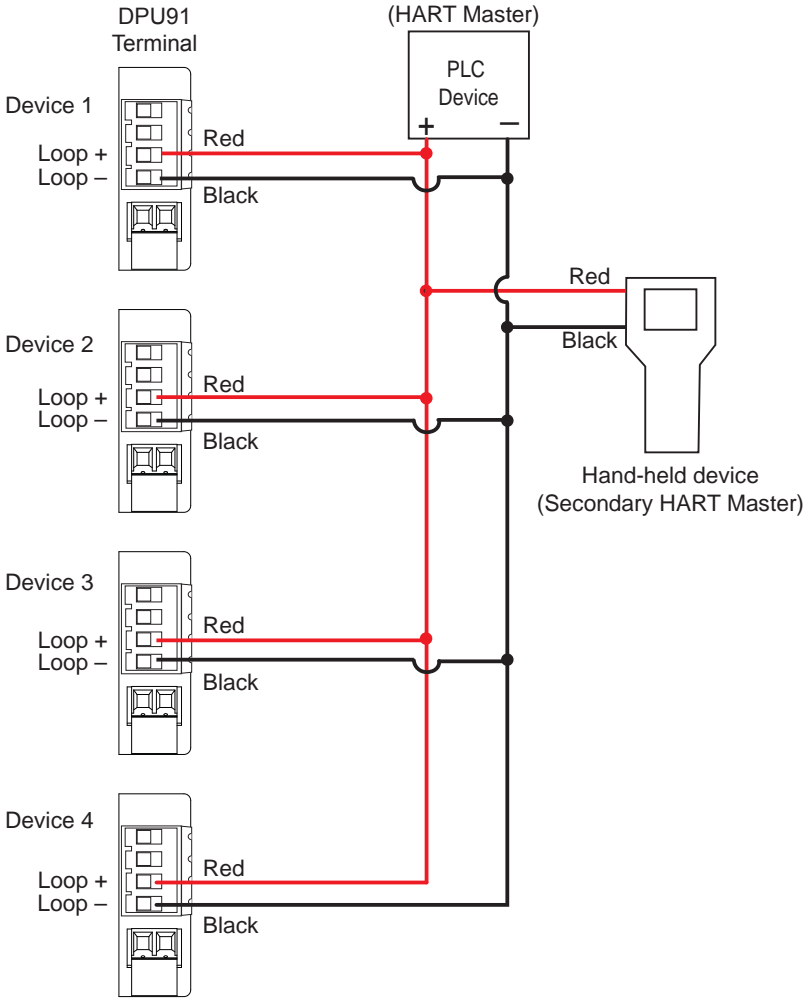

Operation

Loop Powered systems require a minimum of 24 VDC.

If connecting with DC, nominal 12 VDC is acceptable (see Power Wiring page 26).

In pH, Conductivity, Resistivity and Salinity systems the secondary variable represents temperature.

Loop Current Trim Procedure

The Loop Current HART commands allow a Master HART device to update a loop current value in the DPU91 and to perform a two-point calibration (zero and span) of the loop current.

1. Use Command 40 (Enter/Exit Fixed Current Mode) to update the 4.00 mA current.
2. Using the measured value of your reference instrument (either a digital multimeter or the HART Master device), set the zero trim using Command 45 (Trim Loop Current Zero). The transmitter will then trim its calibration and return the loop current value in the response message. The response value may differ slightly from the value sent by the Master due to rounding.
3. Use Command 40 (Enter/Exit Fixed Current Mode) to update the 20.00 mA current.
4. Using the measured value of your reference instrument (either a digital multimeter or the HART master device), set the span trim using Command 46 (Trim Loop Current Gain). The transmitter will then trim its calibration and return the loop current value in the response message. The response value may differ slightly from the value sent by the Master due to rounding.
5. Repeat steps 1 through 4 as needed to gain the accuracy desired.
Once the loop current is calibrated to your satisfaction, return the device to normal operation by issuing Command 40 (Enter/Exit Fixed Current Mode) with a value of 0.0. This will take the DPU91 out of fixed current mode.

Note:

The following are not accessible via the DPU91 keypad with the DPU90-COMM installed:

- Trim Loop Current
- Test Loop Current

These functions are only accessible via the HART interface.

Changes to Units of Measure in Transmitter

HART devices can be used to change the units of measure in a DPU91 Transmitter.

After an update, you must cycle power to the DPU91 (remove power for 5 seconds, then restore power). In a flow system, the units update automatically and it is not necessary to cycle power to the transmitter.

HART Commands

Universal Commands

All HART Rev. 7.2 Universal Commands are supported:

CMD ID	Function	CMD ID	Function
0	Read Unique Identifier	14	Read Primary Variable Transducer Information
1	Read Primary Variable	15	Read Device Information
2	Read Loop Current And Percent Of Range	16	Read Final Assembly Number
3	Read Dynamic Variables And Loop Current	17	Write Message
6	Write Polling Address	18	Write Tag, Descriptor, Date
7	Read Loop Configuration	19	Write Final Assembly Number
8	Read Dynamic Variable Classification	20	Read Long Tag
9	Read Device Variable With Status	21	Read Unique Identifier Associated With Long Tag
11	Read Unique Identifier Associated With Tag	22	Write Long Tag
12	Read Message	38	Reset Configuration Changed Flag
13	Read Tag, Descriptor, Date	48	Read Additional Device Status

Command 0 – Read Unique Identifier

Returns device type, device and software revision levels, device status, and codes for the manufacturer and product information.

Command 1 – Read Primary Variable

Returns the numeric value of the Primary Variable (the 4 to 20 mA current loop) and the unit code for that value (e.g. '45.3' and 'Degrees Celsius').

Command 2 – Read Loop Current and Percent of Range

Returns the loop current value of the 4 to 20 mA current loop and the percent of range (e.g. '12.0' and '50%').

Command 3 – Read Dynamic Variables and Loop Current

Returns the loop current value of the 4 to 20 mA current loop, as well as the numeric value of the Secondary Variable (if present) and the Secondary Variable's unit code.

Command 6 – Write Polling Address

Enables (or disables) Multi-Drop mode. While in Multi-Drop mode, loop current is held at a fixed value and is no longer available for signaling. Also sets the polling address of the device for Multi-Drop mode.

Command 7 – Read Loop Configuration

Reads the polling address of the device and the loop configuration (see Command 6).

Command 8 – Read Dynamic Variable Classifications

Returns the classification code for the Primary Variable and Secondary Variable (if present).

Command 9 – Read Device Variable with Status

Returns the value, status, variable code, variable classification and unit code of up to four device variables.

Universal Commands - Continued

Command 11 – Read Unique Identifier Associated with Tag

Returns all identity information associated with the device, i.e., the device type, device revision level and Device ID. Issued using the 'tag'.

Command 12 – Read Message

Read back the message stored in the device (see Command 17).

Command 13 – Read Tag, Descriptor, Date

Reads the tag, descriptor and date values contained within the device (see Command 18).

Command 14 – Read Primary Variable Transducer Information

Reads transmitter serial number, unit code, upper and lower limits and minimum span for primary variable.

Command 15 – Read Device Information

Returns the alarm selection code, transfer function code, upper and lower range values, write protect code and unit code.

Command 16 – Read Final Assembly Number

Returns the assembly number of the device. This will be defined by the customer (see Command 19).

Command 17 – Write Message

Write a message to be stored in the device (see Command 12).

Command 18 – Write Tag, Descriptor, Date

Writes the tag, descriptor and date values into the device (see Command 13).

Command 19 – Write Final Assembly Number

Writes the final assembly number of the device (see Command 16).

Command 20 – Read Long Tag

Read the 32-byte long tag. The 'long tag' is separate from the 'tag' that is used in Commands 13 & 18.

Command 21 – Read Unique Identifier Associated with Long Tag

Returns all identity information associated with the device - the device type, device revision level and Device ID. Issued using the long tag.

Command 22 – Write Long Tag

Write the 32-byte long tag (see Command 20).

Command 38 – Reset Configuration Changed Flag

Resetting the device's configuration changes counter back to 0.

Command 48 – Read Additional Device Status

Returns extended device status information.

Supported HART Common Practice Commands

The following Common Practice Commands are supported.

CMD ID	Function
40	Enter/Exit Fixed Current Mode
45	Trim Loop Current Zero
46	Trim Loop Current Gain
54	Read Device Variable Information

Command 40 - Enter/Exit Fixed Current Mode

The loop current of the DPU91 is set to the value transmitted in the command (in milliamperes). Setting a level of '0' exits Fixed Current Mode.

If the device is in Multi-Drop mode, Error Code 11 will be returned.

Command 45 – Trim Loop Current Zero

The DPU91 will trim its offset of the loop current to match the loop current value sent to it. This is typically performed at 4.00 milliamperes to optimize calibration.

Command 46 – Trim Loop Current Gain

The DPU91 will trim the gain of the loop current to match the loop current value sent to it. This is typically performed at 20.00 milliamperes to optimize calibration.

Command 54 – Read Device Variable Information

Returns serial number, limits, damping value and minimum span for a selected device variable.

Unit Codes

HART Commands

The DPU90-COMM module uses standard HART Foundation Protocol 7.2 unit codes.

The unit code allows the HART Master to interpret and display the units of measure (e.g., GPM, PPB, °F, etc.) with two exceptions.

The following Unit Codes will not be interpreted by the HART Master:

Code	Measurement Unit
240	Cubic Centimeters
244	Parts per Thousand

A HART Master will display these unit codes instead of the units of measure that the code represents.

13. Installation

System Start-up: Step 1

Prepare the transmitter installation location.

If the back of the transmitter is difficult to access when installed, wire the removable terminal blocks first, then install it completely.

Next step: Wiring (see pg. 20)

For future reference, for each installation, it is recommended to record the part number and serial number of each of the components listed here:

Facility Tag Number or System ID (user assigned):	_____		
Base unit	DPU91 / DPU91P	S/N	_____
Relay Module	DPU90-R	S/N	_____
Cond/Res Module	DPU90-C	S/N	_____
COMM Module	DPU90-COMM	S/N	_____
Batch Module	DPU90-BCM	S/N	_____



Do not mount in direct sunlight.

Field Mount Installation

Field mounting requires a separate mounting kit (see Ordering Information, page 70):

- **PHTX-27** and **FP90UM** Universal Mount Kit
- **FP90IM** or **FP90IM34** Integral Mount Kits
- **DPU90-AK** Angle Adjustment Adapter Kit (accessory for either of the above)

Field installation instructions are included with each of the mounting kits.

For sufficient wiring clearance, the DPU90-AK (Angle Adjustment Adapter) is required for Field Mount installations using the DPU90-C (Direct Conductivity/Resistivity Module).

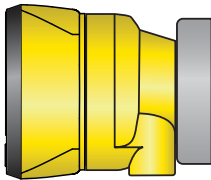

Field Mount with
PHTX-27 and **FP90UM**
Universal Mount Kit

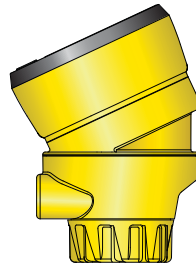

Field Mount with
FP90IM or **FP90IM34**
Integral Mount Kit and
Angle Adjustment Adapter



For Field Mount installations, refer to the wiring diagram inside the Field Mount housing.

Panel Mount Installation

Tools and Equipment Required

- Fine-tooth file
- ¼ DIN punch or jigsaw suitable for cutting panel opening to within 1 mm (0.04 in) tolerance.
- ¼ DIN punches are available and recommended for creating clean, precise openings quickly and easily in most instrument panels.
- If a punch is not available, a jigsaw or other cutting tool can be used.
An adhesive template is provided to help guide the cutting process.
De-burr and smooth the opening with a file.

1. The panel mount transmitter is designed for installation using a ¼ DIN punch. Recommended clearance on all sides between instruments is 25 mm (1 in).
2. Place gasket on instrument, and install in panel.
3. Slide mounting bracket over back of instrument until bracket snaps into latches on sides of instrument.

To remove:

1. Secure instrument temporarily with tape from front or grip from rear of instrument. **DO NOT RELEASE.**
2. Press bracket clips outward and remove.

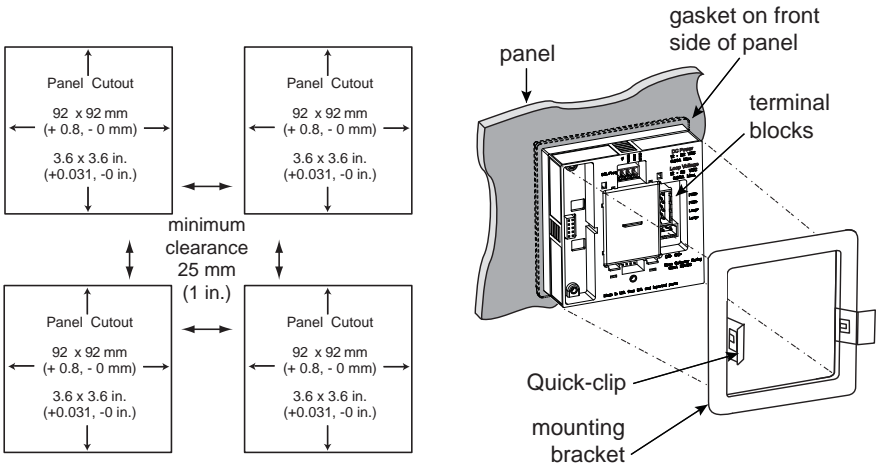

14. Wiring

System Start-up: Step 2

Wire the transmitter for all connections with the power off. Keep any 4 to 20 mA and relay-actuated output devices that are connected to it offline at this time. Wire the sensors (pg. 23), power (pg. 26) and relay(s) (pg. 28).

Next step: Relay Functions (see page 28).

Wiring Tips:

- Do not route the sensor, DC power, or 4 to 20 mA cables in conduit containing AC power wiring. Electrical noise may interfere with sensor signal.
- Routing the sensor cable in grounded metal conduit can help prevent electrical noise and mechanical damage.
- Seal the cable entry points to prevent moisture damage.
- Only one wire should be inserted into a terminal.
- Splice double wires outside the terminal or use appropriate wire ferrule, not to exceed 2 mm (0.08 in) diameter.

All wiring connections to the DPU91 are made via removable terminals.

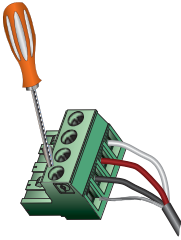

In general:

- The Power, Loop, Relay, and Open Collector plugs accept 12 to 28 AWG wire.
- The S³L/Freq plug and the Cond/Res Module plug accept 16 to 28 AWG wire.
- To reduce fraying: strip 7 mm (0.28 in.) of insulation from wire tips and tin bare ends.
- Insert wire tip or ferrule completely into the terminal and secure with the screw.
- Do not allow any AC leads that may be connected to the internal relays to come in contact with low voltage wiring.

15. Signal Type: Frequency

Omega flow sensors FP-5300, FP-8500, FP-5600, FP-5200, FPB, FP-2540, FP-3-1500, FP-5060, FP-5070 provide a frequency output

Omega flow sensors FMG-3000 and FMG-550 can be configured with either Digital (S³L) or Frequency outputs, see pages 20 and 21).

The maximum allowable cable length for sensors with frequency output is dependent upon the output signal strength of the sensors themselves, and the degree to which the signals are susceptible to EMI or "noise." This is largely a function of whether the sensors are self-powered (FP-5300, FP-8500, and FP-5200), or powered by an external source.

- The input terminals on the DPU91 carry frequency data signals from the sensor.
- Do not route sensor or output cables in conduit containing AC power wiring. Electrical noise may interfere with sensor signal.
- Routing cable in grounded metal conduit will help prevent electrical noise and mechanical damage.
- Seal cable entry points to prevent moisture damage.
- Only one wire should be inserted into a terminal. Splice double wires outside the terminal.
- In case of noise interference, ground the sensor SHIELD wire to a local earth ground at a point near the sensor.
- Consult the sensor manual for additional wiring information.

16. Signal Type: Digital (S³L)

- The input terminals on the DPU91 carry Digital (S³L) serial data from the sensor.
- Do not route sensor or output cables in conduit containing AC power wiring. Electrical noise may interfere with sensor signal.
- Routing cable in grounded metal conduit will help prevent electrical noise and mechanical damage.
- Seal cable entry points to prevent moisture damage.
- Only one wire should be inserted into a terminal. Splice double wires outside the terminal.
- TOTAL cable length from I/O devices to transmitter must not exceed 305 m (1000 ft).
- In case of noise interference, ground the sensor SHIELD wire to a local earth ground at a point near the sensor.
- Consult the sensor manual for additional wiring information.
- The maximum cable length of the Digital (S³L) bus varies depending on the types of sensors connected and the size of the conductors in the cable. For best results, determine the maximum cable length for the system before routing cables.
- There are several methods that can help route the digital cables and remain within the distance limitations.

Maximum total cable length of the Digital (S³L) Bus:

Frequency Output Flow sensors	Maximum Cable Length	
	60 m (200 ft)	305 m (1000 ft)
FP-5300 / 5800	X	
FP-5200	X	
FP-5060 / 5070		X
FP-5600 / 5800A		X
FP-2540		X
FMG-3000 / 550		X

The quality of the cable used in the bus determines the maximum length of all branches combined.

The maximum cable length may not exceed 305 m (1000 ft), regardless of current requirements.



In case of noise interference, connect the cable shield to earth ground.

Sensor model	Freq Output	Digital (S ³ L) Output	Run on Loop Power
FP-2540 / 5200 / 5300 / 5600 / 8500	X		X
FP-5060 / 5070	X		
FMG-3000 / 550	X	X	
PHE-2724 / 2726 ORE-2725		X	
PHEH-275X		X	X*
CDCE-90-X		X	
CDE-285X		X	
CDTX-285X		X	

*A minimum of 24 VDC Loop Power is required for the PHEH-275X.

17. Terminal Identification



The DPU91 requires regulated **10.8 to 35.2 VDC (24 VDC nominal)** from an external power supply (not supplied).
 Maximum current draw is:
200 mA = DPU91 without Relay module
300 mA = DPU91 with Relay module

- **Terminals 1-2: DC Power**
 Required by the instrument
 - 10.8 to 35.2 VDC input power to sensors, relays and the LCD backlight
- **Terminals 3-4: Loop Power (may also be used for system power)**
 - 10.8 to 35.2 VDC
 - NOTE:** Backlight, LEDs, and optional Relay Module do not operate on loop power. Any connected sensors or sensor electronics that cannot operate on loop power will also be inoperative.
- **Terminals 5-6: Open Collector**
 - Software selectable for Normally Open or Normally Closed.
 - May be disabled (Off) if not used.
- **Terminals 7-10: Digital (S³L)/Frequency Input**
 - 7: V+: +5 VDC out to sensor (black wire)
 - 8: DATA: Input signal from sensor (red wire)
 - 9: GND: Sensor ground (white wire)
 - 10: SHLD: Cable shield

Digital (S³L)/Freq

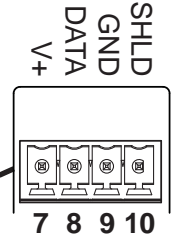

Connect sensor wires here as shown in the following figures.

Power

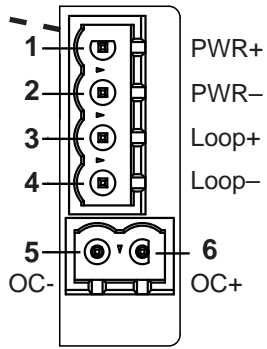

Connect power and open collector wires here as shown on pages 26 and 27.

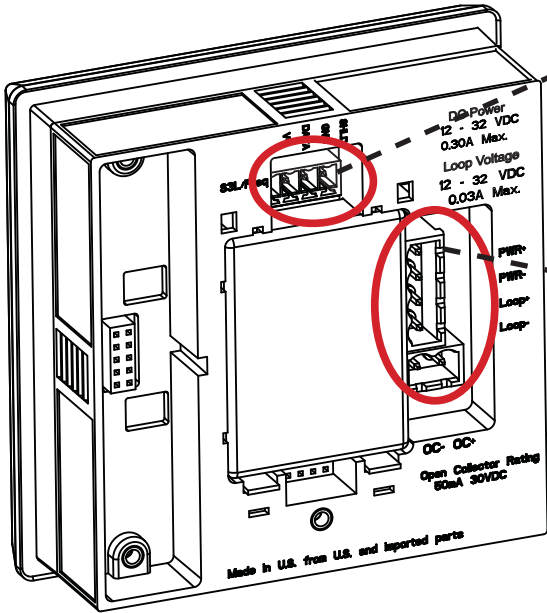

18. Sensor Wiring

NOTE: Loop Power cannot be used to power Omega models FP-5060, FP-5070, FMG-3000 or FMG-550 Flow sensors.

Wiring for:

FP-5300 FP-5600 FP-2541
 FP-5800 FP-5800A FP-3-1500-3B

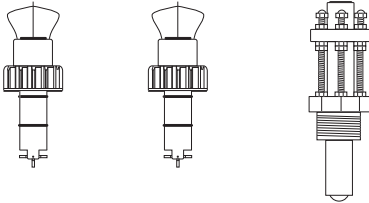

FP-5200 FP-5060 FP-5070

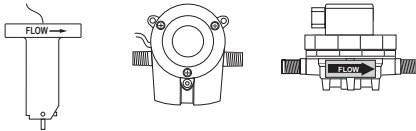

Frequency

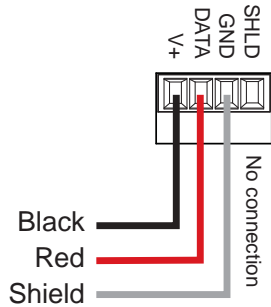

Wiring for:

PHEH-275 PHEH-275Y

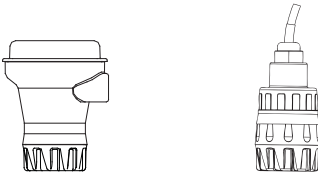

FMG-3000-PP-D* CDTX-2850

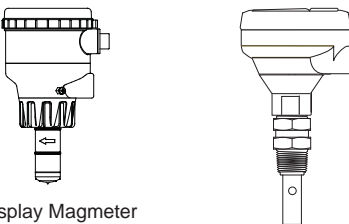

*Display Magmeter

DPU91 Inputs

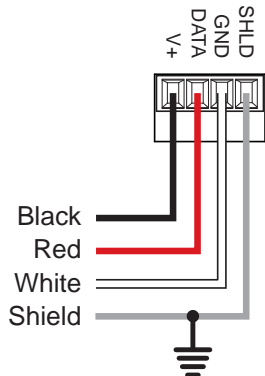

NOTE: The CDTX-2850 has no SHIELD wire.

18. Sensor Wiring - continued

Wiring for:

FMG-3000-PP
Blind Magmeter

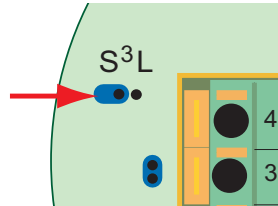
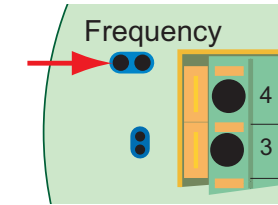
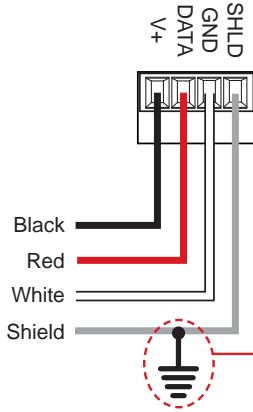
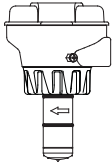

Only in case of EMI interference
See Frequency Output Technical Notes
(FMG-3000 & FMG-550)

Input Wiring for FMG-3000 and FMG-550 sensors

- Either Frequency or Digital (S³L) may be used.
- **Omega recommends using Digital (S³L) output for increased accuracy and the ability to display reverse flow (negative numbers).**
- Input type is selected by choosing between "SENSOR FREQ" and "SENSOR S3L" in the FLOW sensor type INPUT menu (see page 43).
- Loop Power cannot be used to power these sensors.

Wiring for:

FMG-550

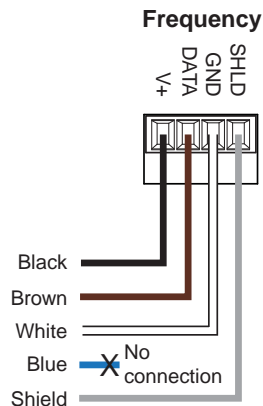
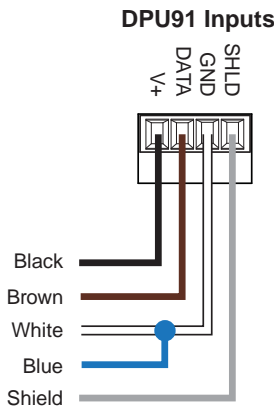

19. Sensor Wiring Technical Notes

Flow Sensors Technical Notes:

- See corresponding product manuals for maximum cable length.
- Maintain cable shield through cable splice.
- Route sensor cable away from AC power lines.
- FP-5200, FP-5300, and FP-5800 installations, connect the silver (shield) wire to earth ground in case of EMI noise interference.

PHEH-275, FMG-3000-PP-D, CDTX-2850 Technical Notes:

- Use three conductor shielded cable for sensor cable splices up to 305 m (1000 ft) max.
- Maintain cable shield through cable splice.
- Route sensor cable away from AC power lines.
- Connect the silver (shield) wire to earth ground in case of EMI noise interference.

CDTX-2850 Technical Notes:

- The CDTX-2850 has no SHIELD wire.
- To work correctly with the DPU91, the CDTX-2850 must be set for the custom cell constant or the actual probe cell constant and the DPU91 set for a 1.0 cell constant.

FMG-3000 Technical Notes:

- When the blue jumper illustrated here is placed over both pins, the FMG-3000-PP (Blind Magmeter) outputs an open collector frequency signal.
- When the jumper is removed (or placed over one pin for storage) the FMG-3000-PP outputs a digital (S³L) signal (recommended).

FMG-3000 and FMG-550 Frequency Output Technical Notes:

- The frequency output will be displayed as positive flow regardless of the flow direction.
- 5 VDC power required by the FMG sensors is supplied by the DPU91. No additional power is required.
- Connect the silver wire (shield) to earth ground in case of EMI noise interference.
- If EMI noise interference continues, disconnect silver wire (shield) from DPU91.

FMG-550 Technical Notes:

- The FMG-550 open collector frequency signal output can be connected to the DPU91.

20. Power Wiring



CAUTION!

DO NOT connect your DPU91 to AC power.
The DPU91 MUST be powered by
10.8 to 35.2 VDC ONLY.

Stand-alone application, no current loop used

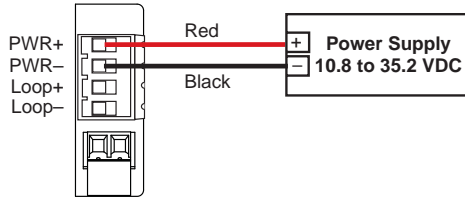

Connection to a PLC/Recorder, separate supply

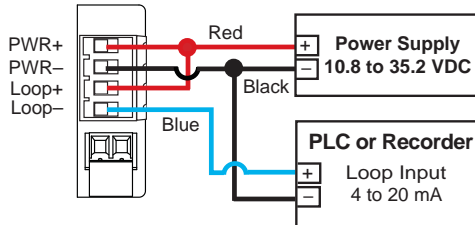

Loop Powered

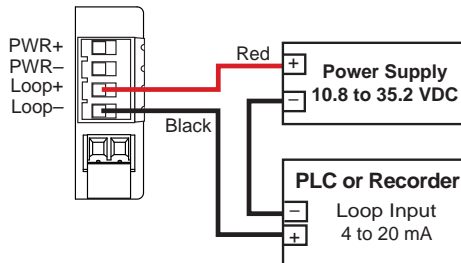

NOTE:

Loop Power cannot be used to
power certain Omega sensors.
See table on page 21.

21. Open Collector Wiring

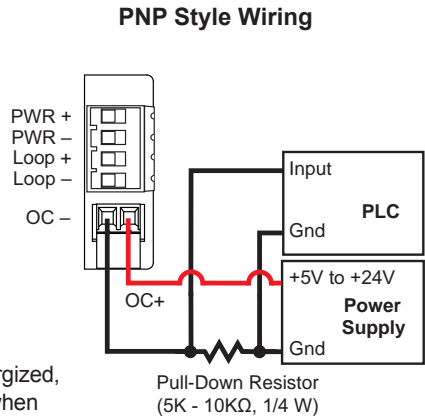
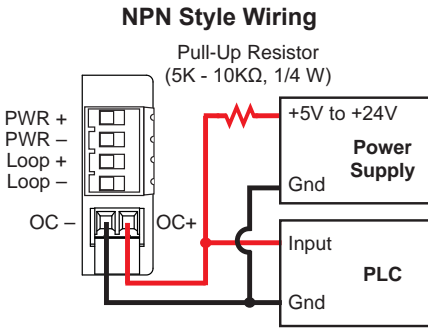

If PLC needs 0 logic input when relay is not energized, set NORMAL to CLOSED in the RELAY menu when using the Open Collector (R1) with NPN style wiring.

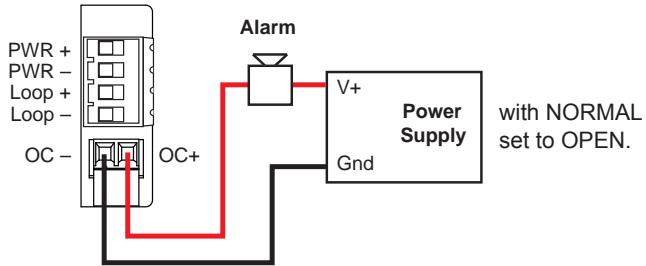

- DPU91 Open Collector (R1) output provides high-speed switching capability.
- Signal frequencies can reach 400 pulses per minute.
- DPU91 Open Collector (R1) output connection is dependent upon the type of circuit being controlled by the output.
- Most indicating instruments or control system inputs require a signal voltage of 0 to 5 V (TTL or CMOS logic levels) or 0 to 24 V.
- DPU91 Open Collector output circuits must be equipped with a pull-up or pull-down resistor (not supplied)
- Quality regulated 5 to 24 V (depending on the application) power supply (not supplied) is recommended to function properly.

22. Relay Module Wiring

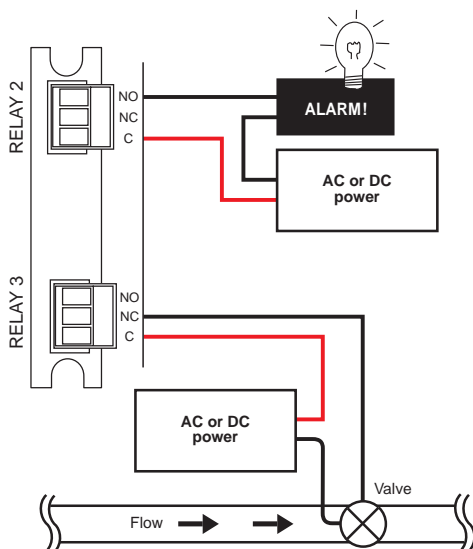

NO = normally open
(closes when energized)

NC = normally closed
(opens when energized)

The alarm is OFF during normal operation, and will go ON when relay energizes according to DPU91 Relay settings.

The valve is ON during normal operation, and will go OFF when relay energizes according to DPU91 Relay settings.

23. Relay Functions

System Start-up: Step 3

Set your relay functions to your own application requirements.

Next step: System Setup (see page 36).

Once a setting is saved it becomes immediately active.

1. Go to the Relay Menu (RELAY flashing on screen, press ENTER).
2. If prompted, select desired source.
3. Press ▼ to relay **MODE** selection screen.
4. If necessary, press ► and then ▼ or ▲ to select **R1 MODE LOW**. Press ENTER to confirm.
5. Press ▼ to **R1 SET LOW**. Press ► to enter GPM value of 5.5.
6. Press ENTER to save.
7. Scroll ▼ to the **R1 HYSTERESIS** menu.
8. Press ► to edit.
9. Set the hysteresis for this relay. This affects the turn off only: **2.5 gpm**.
10. Press ENTER.
11. Scroll down ▼ to the **R1 ON DELAY** menu.
12. Press ► to edit.
13. Set the turn-on delay in seconds for the relay: **15.0**.
14. Press ENTER.
15. Exit to View Mode. ▲▼ ▼▲

- Relay function can be tested in the RELAY menu.

SET LOW + hysteresis = OFF point: 5.5 + 2.5 = 8.0

24. Relay and Open Collector Outputs

RELAY HIGH and LOW Settings

Depending on the desired function of the circuit attached to the Open Collector (R1) output, it may be necessary to have the Open Collector turned “on” or “off” when the criteria for the activation of this output are met.

If the DPU91 is set to operate in RELAY LOW mode, when the user-defined condition for the activation is met (e.g. exceeding an alarm limit) the Open Collector switch is turned “on.” If wired as standard “NPN-style” output (see previous page) the logic level of the attached control system or PLC input consequently becomes “low” logic level (when NORMAL is set to OPEN).

If a high input logic level is required for activation, it can be accomplished in one of three ways. In order of preference,

1. Change the Open Collector (Relay 1) output function to “high” in the instrument's RELAY menu
2. Wire the Open Collector (R1) output “PNP” style as described on the previous page
3. Set the Open Collector (R1) to NORMAL CLOSED in the RELAY menu.

Fail-Safe Behavior

No matter the setting, the Open Collector output turns off if the DPU91 loses power.

This must be taken into account when evaluating system failure consequences. If the system layout requires a “closed” or “on” condition for the output in case of power loss, a mechanical dry-contact relay (NC contacts) must be used instead of the Open Collector (R1) output.

Voltage and Current Limitation

The supply voltage in the Open Collector output circuit MUST be limited to the specified maximum Open Collector voltage (see operating manual for specific instrument).

The use of a quality 5 to 24 V (depending on the application) regulated power supply (not supplied) is recommended.

The current through the Open Collector switch also must be limited.

Typical Open Collector outputs allow only for 10 to 50 mA switch current.

Exceeding this current limit can burn out the Open Collector output components immediately.

Load and Pull-Up/Down Resistor Considerations

By utilizing basic arithmetic and Ohm's Law, the safe limits of load resistance can be determined.

When the Open Collector switch is closed, almost the entire supply voltage is applied to the load (e.g., the pull-up or pull-down resistor, the alarm horn input, a potential power relay coil or annunciator lamp).

The resulting current through the load and through the Open Collector switch, as well, can be calculated as:

$$(\text{Current}) = (\text{Supply Voltage}) / (\text{Load Resistance})$$

24. Relay and Open Collector Outputs - continued

The DPU91 open collector and relays are selectable and configurable and can be used as switches that respond when the process value moves above or below a user-defined setpoint or it can be used to generate a pulse at a rate proportional to the process value.

They can be used for Low Alarm, High Alarm or Proportional Pulse triggering related to the process value. All relay functions are set up in the RELAY menus.

Open Collector Output

- Longer life than a mechanical relay
- No moving parts
- Faster ON/OFF switching than mechanical relays
- Can switch DC voltage only (< 30 VDC)
- Not recommended for use with inductive loads

- ◇ Relay energized
- ◆ Relay de-energized

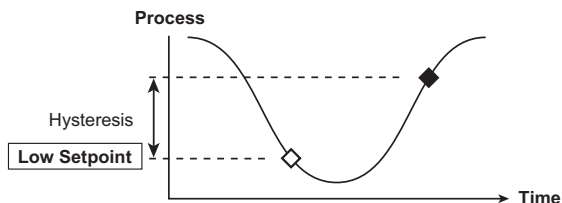

- ◇ **Low Setpoint:**
Relay is on when the measured value is less than the setpoint.

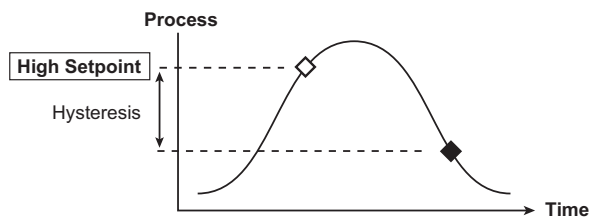

- ◇ **High Setpoint:**
Relay is on when the measured value is higher than the setpoint.

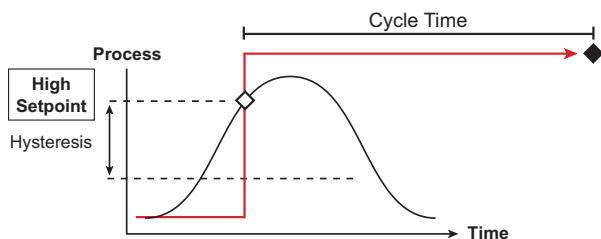

- ┌ **Cycle High/Low:**
The relay can stay energized for a set length of time after the process value goes above (or below) the setpoint.



CAUTION

If power is lost to the DPU91 Transmitter during a cycle, the Cycle Time will reset.

If the condition still exists after power is restored, the relay will be energized for the complete Cycle Time.

The relay will stay on for the CYCLE TIME and then turn off, even if the process value is still above (or below) the setpoint. The cycle will not repeat until the process value goes below (or above) the setpoint minus the hysteresis after the relay times out.

In FLOW, Cycle High activates the relay each time the volume reaches the SET VOLUME setpoint (see page 40).

NOTE:

To reset the timer (or volume in Flow): in the RELAY menu, select TEST RELAY function. The timer will reset to 0 if the condition no longer exists when the TEST is performed. The timer will restart if the condition still exists.

24. Relay and Open Collector Outputs - continued

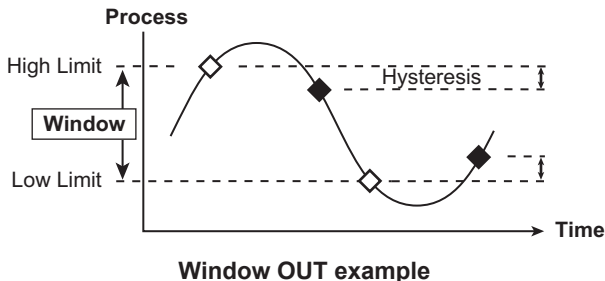
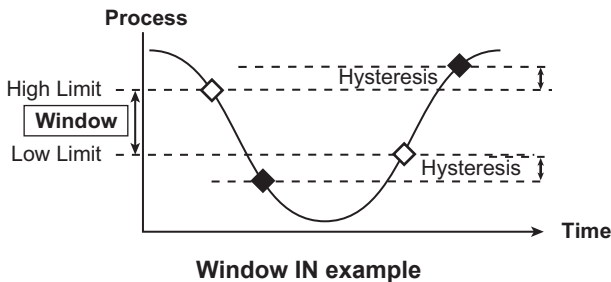

- ◇ Relay energized
- ◆ Relay de-energized

◆ **Window In/Out:**
Relay is on when the value is higher or lower than the high or low setpoint.

WINDOW IN =
relay on if measurement is inside the window of two setpoints. Measurement inside the two setpoints is abnormal condition.

WINDOW OUT =
relay on if measurement is outside the window of two setpoints.

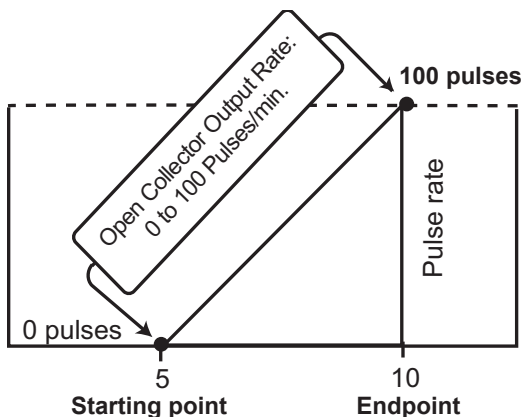

In the example:

- The output will be 0 pulses/min. when value is less than 5.
- The output will be 50 pulses/min. when value is 7.5.
- The output will be 100 pulses/min. when value is greater than 10.

▭▭ Proportional Pulse Operation:

The transmitter can output a pulse at the rate defined by the settings in the CAL menu and the sensor input. The maximum pulse output from the relays is 300 pulses per minute. Example usage would be to control solenoid-operated dosing pumps.

For example:

As the process value drops below the setpoint, the output will start pulsing in relation to the process value, the maximum pulse endpoint and the programmed pulses/minute.

The pulse rate will change as the process value changes and approaches the programmed endpoint. This functionality can be used to precisely control the process.

The starting point, endpoint, and maximum pulse rate are selectable in the RELAY menus.

NOTE: Relay LEDs are not lit in PULSE mode.

24. Relay and Open Collector Outputs - continued

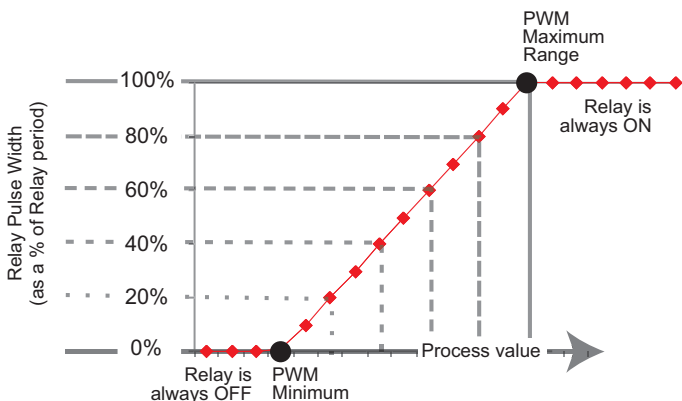

• Pulse Width Modulation

PWM automatically varies the ratio of ON time to OFF time proportional to minimum and maximum range settings.

The relay period is the sum of the time a relay is ON and the time it is OFF.

Relay pulse width is the time the relay is ON.

The DPU91 must be programmed with the relay period, and with the low and high setpoints.

NOTE: The PWM mode is not used for Pressure applications.

NOTE: Relay LEDs are not lit in PWM mode.

Example:

- The pulse width will be 0% of the relay period (relay always OFF) when the process value is less than the minimum range.
- The pulse width will be 100% of the relay period (relay always ON) when the process value is greater than the maximum range.
- The pulse width will be 60% of the relay period when the process value is at 60% of the span between the minimum and maximum range.

24. Relay and Open Collector Outputs - continued

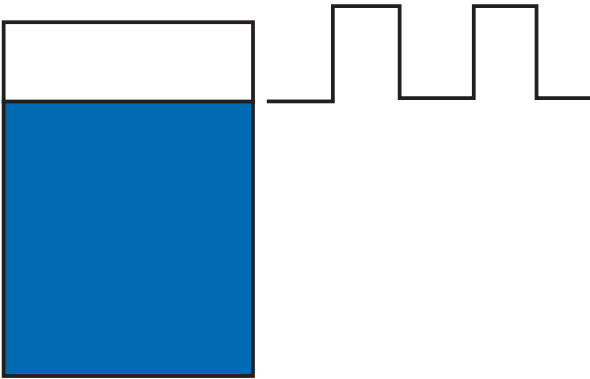

- **Volumetric Pulse**

A pulse is generated each time a specified volume of fluid is registered.
For flow inputs only.

NOTE: Relay LEDs are not lit in VOLUMETRIC PULSE mode.

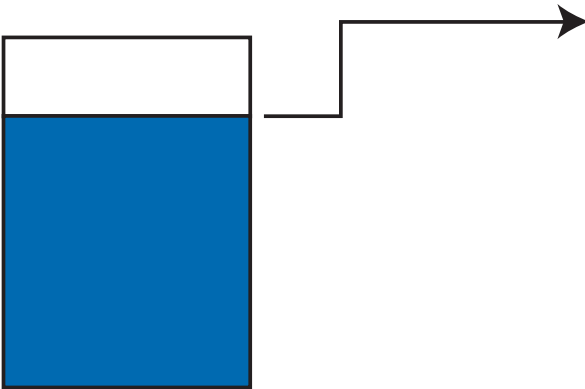

- **Totalizer Volume**

Relay activates and latches when a specified volume of fluid is registered.
For Flow inputs only.

Total Volume mode counts the TOTALIZER Units until the setpoint volume is reached, then turns on the relay until the resettable totalizer is reset.

If the Resettable Totalizer reading is greater than the setpoint, the relay will be turned on immediately. The relay will be off when the totalizer is reset to zero.

This mode is useful to trigger a reminder when a process is due, as for a backwash cycle or filter change.

25. Operation

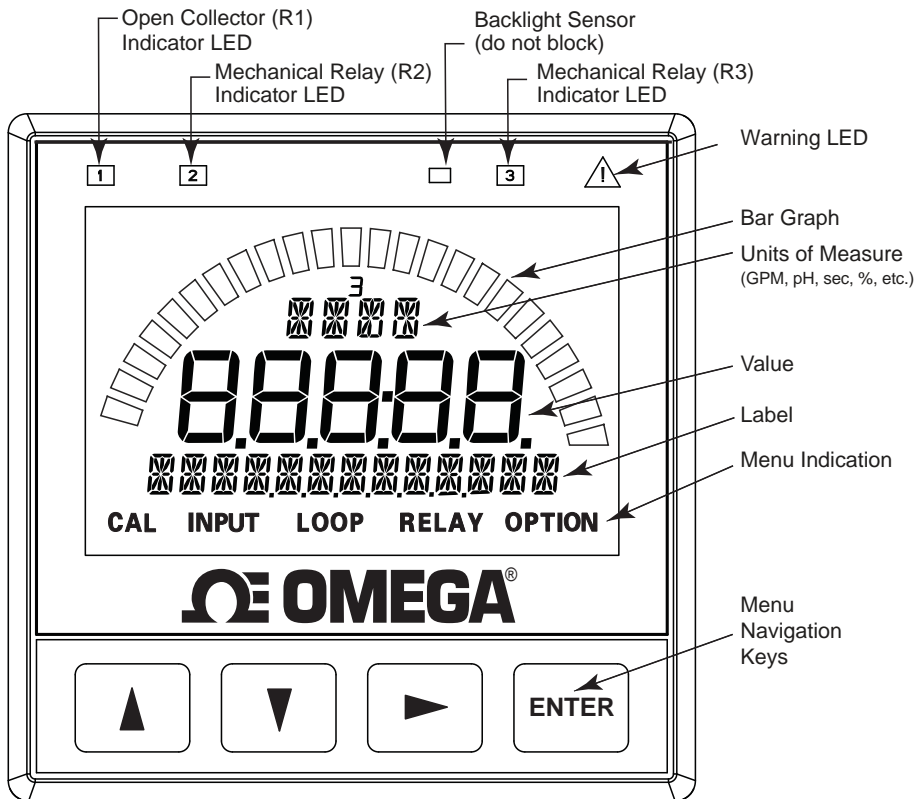

All possible segments shown in this illustration.

The instrument's software controls which segments are shown at any particular time. Only the bar graph and Omega logo are visible when the unit is turned off.

Warning LED will be lit when No Sensor or Wrong Sensor is detected in Digital (S³L) mode.

UP, DOWN keys

Scroll through Menu options or adjust values during editing

Press both together to exit a menu or escape without saving

RIGHT key

Select item or character to edit

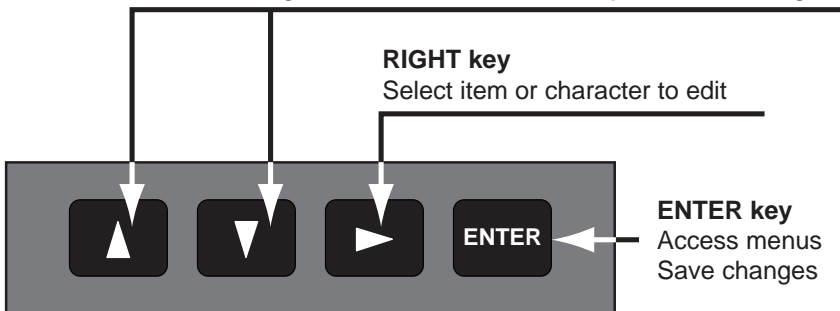

25. Operation - continued

Keypad Functions

The four buttons of the keypad are used to navigate display modes according to the descriptions in this table. Notice that the function of each button may change depending on the display mode.

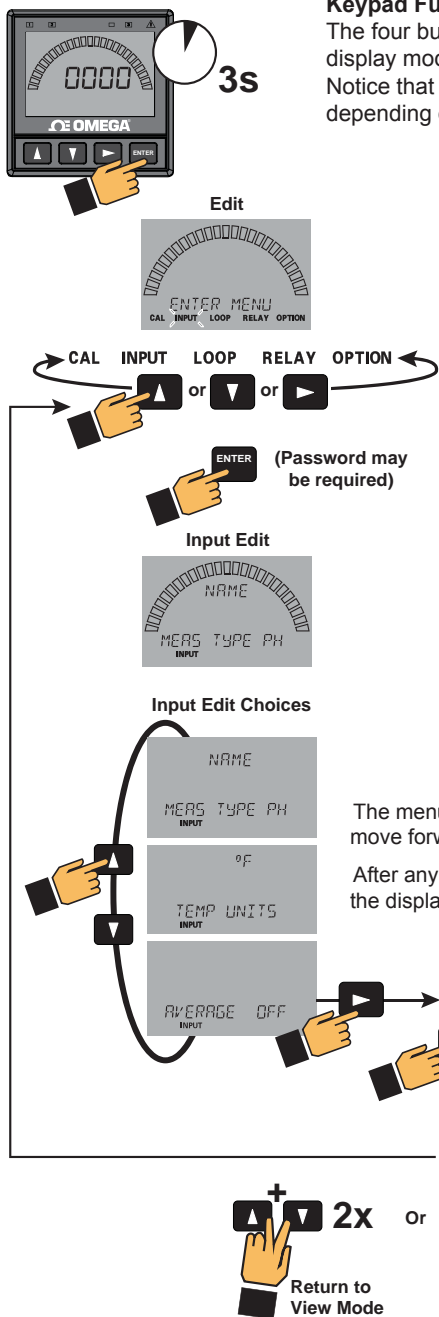

System Setup: Menu Navigation

This basic operating procedure repeats throughout the DPU91 program:

1. Press ENTER for 3 seconds to enter MENU mode.
2. Press ► to move to the desired menu then press ENTER to select it. (Password may be required.)
3. Press ▲ or ▼ to select the desired menu item for editing.
4. Press ► to edit the value/selection.
5. Press ENTER to store the new value.
6. Press ▲ or ▼ to select another menu item. Repeat steps 3-5 as required.
7. Press ▲+▼ to select a different menu to edit. Repeat steps 2-5 as required.
8. When finished editing, press ▲+▼ again to return to normal operation.

The menu is constructed in a loop, so you can move forward and backward to select an item.

After any item is saved (by pressing ENTER), the display will return to the previous menu.

26. Menu System

System Setup Menu

All of the basic system setup functions are automated in the DPU91 for many sensors and sensor electronics. This includes identifying the sensor connected to the DPU91, and configuring the display for the sensor. After installation and wiring is completed, apply power to the DPU91.

When the DPU91 is first powered on, it will attempt to determine the sensor type connected when ENTER is pressed (display will display LOOKING FOR). If no sensor is attached to the DPU91, the words "TYPE" and "FLOW" are displayed. When a sensor is attached, the DPU91 will attempt to determine the instrument type. If the DPU91 does not identify your sensor type, use the ▲ and ▼ keys to scroll through the available sensor types.

As you scroll through the available sensor types, press ► to select the desired sensor and then press ENTER.

You may change sensor type after initial power-on (if sensor type is changed after your DPU91 is already in service).

Enter the INPUT menu, scroll to TYPE, press ►, and scroll to select the desired sensor type (you may be prompted for your password). Press ENTER.

The bottom line will display ALL SETTINGS WILL BE RESET. ARE YOU SURE?

The top line of the display will blink NO (unless switching from Factory mode).

Press ▼ or ▲ to select YES. Press ENTER again to finalize your selection.

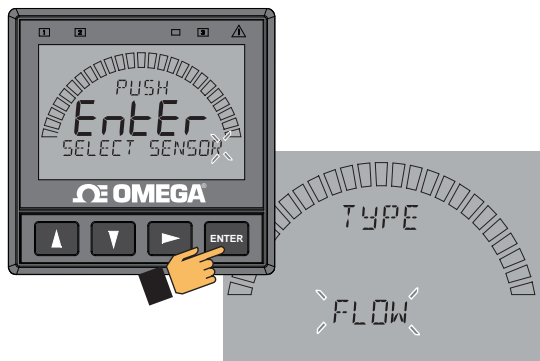

CAUTION:

Omega **strongly** discourages changing the sensor type away from the correct sensor.

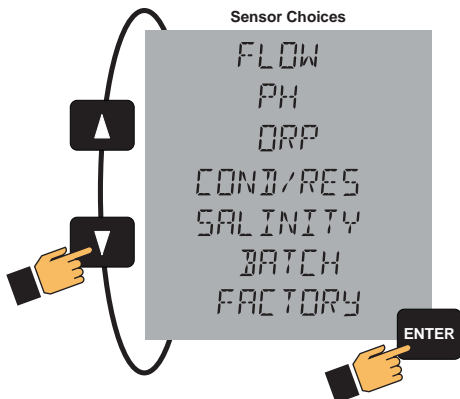

NOTE:

The DPU91 displays the BATCH instrument type ONLY if the Batch Module is installed.

26. Menu System - continued

VIEW Mode Overview

The top level of menus is referred to as the **VIEW Mode**.

This view displays measurement values as well as current outputs and relay status.

The radial bar graph represents the measurement value that is also displayed in the 7-segment numeric field below the bar graph. The bar graph is primarily used to display the full scale range of the sensor, but can be scaled via a menu item.

During normal operation, the DPU91 displays the VIEW mode.

- To select a display, press the ▲ or ▼ arrow keys.
The display selections scroll in a continuous loop.
- Changing the display selection does not interrupt system operations.
- No password is necessary to change display selection.
- Output settings cannot be edited from the View Mode.
- The display will return to the VIEW mode if no button is pressed for 10 minutes.

Error Handling

Errors occurring while in the VIEW Mode show a specific message (e.g., CHECK SENSOR).

This message is displayed every 10 seconds and stays on for 5 seconds.

Once the error is resolved or cleared, the error message stops.

Scrolling

In some cases, more than one message or measurement may need to be displayed.

This is accomplished by alternating the message portions across the screen.

MENU Mode Overview

The MENU mode enables the user to view and configure all menu items.

The five menus available are: **CAL**, **INPUT**, **LOOP**, **RELAY**, and **OPTION**.

MENU Mode is entered by pressing and holding ENTER for three seconds.

The ► button is used to change the position of the blinking cursor.

When the desired menu is blinking, press ENTER.

In the selected menu, use the ▲ and ▼ keys to navigate through the menu.

Use the ▲, ▼ and ► keys to edit the selected item (see Menu Navigation, page 35).

To save the new selection, press the **ENTER** key.

A message displaying "Saving..." will be displayed for 3 seconds.

After this message is displayed, the newly selected value will be displayed, if applicable.

26. Menu System - continued

Password Overview

The password is often required to start editing. Once entered correctly, this password will not be needed for subsequent edits. However, once the menu system is exited, the password will again be required when edit mode is re-entered.

Your choice of password (STD or CODE) is selected in the Options Mode.

- **STD**

The standard (STD) password is ▲▲▲▼, pressed in sequence. This password is designed to protect the DPU91 from unintentional changes. It is best suited for systems where a group of people need to be able to change settings.

- **CODE**

The CODE default setting is 0000, adjustable to any 4-digit numerical code up to 9999. Using a personal code provides the maximum degree of security. This code can be modified in the Options mode.



In the MENU mode, if the wrong code or password is entered, an ERROR message is displayed.



To change your CODE, go to OPTIONS mode, enter your desired code and press ENTER. (The STD password cannot be changed.)

27. Common Menus



System Start-up: Step 4

Customize your DPU91 to your own installed sensors.

Common Menus

The menu system shares certain modes between sensor types.

The following describes the EDIT Mode menus common between most sensor types.

NOTE:

Menu and Mode displays shown are examples only. Your displays may vary.

INPUT Menu

	(ALL) Manually select Sensor Type (See page 36 for instruction). Allows user to reset DPU91 Transmitter to Factory settings. NOTE: Omega strongly discourages changing the sensor type away from the correct sensor.
--	---------------------------------------------------------------------------------------------------------------------------------------------------------------------------------------------------------------------------------------

LOOP1 Menu

	(pH, COND/RES, SALINITY only) Set LOOP1 output source: Select either Primary or Secondary measurement of applicable sensor. Secondary measurements: pH, COND/RES, and SALINITY = TEMP
--	----------------------------------------------------------------------------------------------------------------------------------------------------------------------------------------------

	(COND/RES only) Select LIN/LOG. Default = LIN. See LOG Current LOOP Output discussion in Appendix.
--	-----------------------------------------------------------------------------------------------------------

	(ALL) Set value corresponding to desired 4 mA output. 5 digits max. Default = 0 (ORP = -999).
--	------------------------------------------------------------------------------------------------------

	(ALL) Set value corresponding to desired 20 mA output. 5 digits max. (Not shown in COND/RES LOG Mode.) Defaults = 100 (Flow, Cond/Res), 14 (pH), 1000 (ORP), 80 (Sal).
--	-------------------------------------------------------------------------------------------------------------------------------------------------------------------------------

	(ALL) Set desired LOOP1 output value when sensor error (e.g., bad sensor, broken wire) is detected. Select (3.6 mA, 22 mA). Default = 22.
--	--------------------------------------------------------------------------------------------------------------------------------------------------













	(ALL) Allows fine-tuning to compensate for errors in other equipment connected to the DPU91. Adjust the maximum current output. The display value represents the precise current output. Adjustment limits: from 3.80 mA minimum to 5.00 mA maximum. Default = 4.00 mA.
--	--------------------------------------------------------------------------------------------------------------------------------------------------------------------------------------------------------------------------------------------------------------------------------

	(ALL) Allows fine-tuning to compensate for errors in other equipment connected to the DPU91. Adjust the maximum current output. The display value represents the precise current output. Adjustment limits: from 19.00 mA minimum to 21.00 mA maximum. Default = 20 mA.
--	--------------------------------------------------------------------------------------------------------------------------------------------------------------------------------------------------------------------------------------------------------------------------------

	(ALL) Press ▲ or ▼ to manually order any output current value from 3.8 mA to 21.00 mA to test the output of LOOP1.
--	---------------------------------------------------------------------------------------------------------------------------

27. Common Menus - continued

RELAY Menu

	(pH, COND/RES, SALINITY only) Defaults = pH, COND, SAL. Select source for each of R1, R2 and R3 outputs. Choose pH/TEMP, COND/TEMP, SAL/TEMP.
	(ALL) Set Open Collector (R1) as Normally Open or Normally Closed. Default = OPEN.
	(ALL) Select the desired mode of operation for the open-collector (R1) output (OFF, LOW, HIGH, WINDow IN, WINDow OUT, CYC LOW (except FLOW), CYC HIGH, PROP PuLSe, VOL PuLSe, PWM, TOTAL, USP, ERROR mode) (See chart on next page). Default = OFF. Continue stepping through to select R2 and R3 output modes. When MODE is set to ERROR, delays energizing relay until after ON DELAY time expires if sensor problem is detected. See Cycle High/Low discussion on page 30.
	(ALL) Relay turns on if process measurement goes lower than this value. Set desired value (Shown if LOW, WIND IN/OUT or CYC LOW mode). NOTE: The indicator lights do not light up in PROP PLS and PWM modes. The LEDs light up only when the Test Relay options are selected.
	(ALL) Relay turns on if process measurement goes higher than this value. Set desired value (Shown if HIGH or WIND IN/OUT mode). NOTE: The indicator lights do not light up in PROP PLS and PWM modes. The LEDs light only when the Test Relay options are selected.
	(FLOW only) Amount of accumulated flow that must be counted before a pulse is sent out. Relay turns on if flow volume exceeds this value. Set desired value (Shown if CYC HIGH or VOL PLS mode). Default = 100.00.
	(ALL) Hysteresis prevents the system from chattering around the set point. Set amount (in units of measure from INPUT Mode) to add to SET LOW or SET HIGH values. (Shown if LOW, HIGH, WIND IN/OUT, CYC LOW/HIGH or USP mode)
	(COND/RES only) Relay turns on if USP value drifts by this value away from USP limit. (Shown only in USP mode) See Appendix for USP Limits discussion.
	(ALL) Set seconds (up to 9999.9) to wait before activating relay. (Shown if Low, High, WIND IN/OUT, CYC LOW/HIGH or Error mode.)
	(ALL) Set minimum setpoint value for proportional pulsing. (Shown if PROP PLS mode.)
	(ALL) Set maximum setpoint value for proportional pulsing. (Shown if PROP PLS mode.)
	(ALL) Set desired maximum pulse rate (300 max) (Shown if PROP PLS mode.) NOTE: Pulse width fixed at 100 ms.

27. Common Menus - continued

RELAY Menu - Cont.

The display shows '00000' with 'R1 PWM MIN' below it.

(ALL except FLOW)

Set minimum value for pulse width modulation (Shown if PWM mode).

The display shows '00000' with 'R1 PWM MAX' below it.

(ALL except FLOW)

Set maximum value for pulse width modulation (Shown if PWM mode).

The display shows '00' with 'SEC' above and 'R1 CYC TIME' below it.

(ALL) Set time in seconds (up to 99999) for relay to remain on.
See discussion on page 30. (Shown if CYC LOW/HIGH mode.)

The display shows '10000' with 'G' above and 'R1 PLS VOLUME' below it.

(FLOW only) Amount of accumulated flow that must be counted before a pulse is sent out. Set value. (Shown only if VOL PULS.)

The display shows '01' with 'SEC' above and 'R1 PLS WIDTH' below it.

(FLOW only) Set time value for one pulse width.
(Shown only if VOL PULS.)

The display shows '00000' with 'SEC' above and 'R1 PWM PERIOD' below it.

(ALL except FLOW) Set time value for one complete pulse cycle (relay ON time + relay OFF time). (Shown if PWM mode)

The display shows 'tot' with 'R1' above and 'VOL' below it.

(FLOW only) Resettable value that, when exceeded, turns relay on.
Must reset Totalizer (in VIEW Mode) to clear relay.
Set maximum value (Shown only if TOTAL.).

The display shows 'R1 TEST RELAY'.

(ALL) Press ▲ or ▼ to turn relay on or off for testing purposes.
Can also be used to reset or latch/unlatch the relay.
Does NOT reset the Totalizer.











Available Relay Modes by Sensor Type

	Flow	pH	ORP	Cond/Res	Salinity
Off	X	X	X	X	X
Low	X	X	X	X	X
High	X	X	X	X	X
Wind In	X	X	X	X	X
Wind Out	X	X	X	X	X
Cyc Low		X	X	X	X
Cyc High	X	X	X	X	X
Prop Pulse	X	X	X	X	X
Vol Pulse	X				
PWM		X	X	X	X
Total	X				
USP				X*	
Error	X	X	X	X	X

* In USP Relay Mode in Conductivity, Relay Source must be set to COND, TEMP COMP must be set to NONE and Unit Of Measure must be set to μ S.

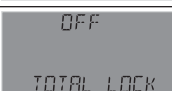
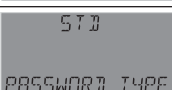
27. Common Menus - continued

OPTION Menu

	Adjust the LCD contrast for best viewing for your environment. A setting of 1 is lowest contrast, 5 is highest. Default = 3.
	Select backlight level (OFF, LOW, HIGH, AUTO). Default = AUTO. NOTE: No backlight when operating on loop power.
	Enter 5 digit value to represent bar at minimum. Default = 0 (ORP = -999).
	Enter 5 digit value to represent bar at maximum. Defaults = 100 (Flow, Cond/Res), 14 (pH), 1000 (ORP), 80 (Sal)
	(ALL) Set the decimal to the best resolution for your application. The display will automatically scale up to this resolution. Select ----., -----, ---.- or --.---. Default = ----.-.
	(FLOW only) Set the decimal to the best resolution for the Permanent Totalizer display. The display will automatically scale up to this resolution. Select ----., -----, ---.- or --.---. Default = ----.-.
	(COND/RES only) Displays mS or μ S as set in COND UNITS in INPUT Mode. Set ON/OFF. Default = OFF.
	(FLOW only) Locks the TOTALIZER output. Select OFF, ON (Does not affect Permanent Totalizer). Default = OFF.
	(ALL) Select STD, CODE. Default = STD.
	(ALL) Enter desired password code. 4-character entry not displayed, ---- displayed instead. (Shown if type = CODE.)
	(ALL) Enter 13-character string, if desired. Default = Blank.
	Enables Remote Setup to configure the DPU91 via a computer and the optional PC COMM tool. Press ► and select YES to enable. REMOTE SETUP flashes when mode is enabled. NOTE: Communication with PC COMM tool is automatic when the DPU91 is in FACTORY state (Enter flashing). Refer to the DPU90-CT PC COMM Tool manual.
	Displays Transmitter Generation Version.

28. Sensor-Specific Menus

The following pages list the sensor-specific settings for each sensor type.

Flow



This is the normal display and does not time out.

FLOW Setup Checklist

1. Make sure FLOW sensor type is selected (see System Setup Menu, page 36).
2. Set the Units of Measurement.
3. Set Sensor Type (Freq or S³L).
4. If LOOP is used, set the minimum and maximum 4 to 20 mA setpoints.
5. Set K-Factor (pulses per Unit Volume) from Flow Sensor manual.
6. Set Totalizer factor.
7. Set Last Cal Date and initials.
8. If desired, set up relay functions for your own application.

VIEW Mode Menu

0 12345678-)	Display the flow rate and the resettable totalizer. Press ► to reset the totalizer (If Reset is locked, enter the password first). Lock or Unlock the totalizer in the OPTIONS menu. This is the resettable totalizer View display.
P 0 12345678-)	Display the Permanent Totalizer value (note the "P" indicating Permanent). Pressing ► displays units of measure.
LOOP 1 720 mA	Displays the 4 to 20 mA LOOP1 output.
RLYS 1 2 3 OFF OFF OFF	Bottom line shows one of three states (OFF, ON, PLS) for each of the three relays. Displays remaining time for CYC LOW or CYC HIGH mode. The relay(s) will remain ON while counting down. NOTE: To reset the timer: In the RELAY menu, select TEST RELAY function. The timer will reset to 0 if the condition no longer exists when the TEST is performed. The timer will restart if the condition still exists.







CAL Menu

NO HOLD OUTPUTS	YES prevents relays from activating while making adjustments, and relays in PULSE mode will suspend pulsing. Output is held until the user exits the CAL menu. Select YES/NO. Default = NO.
KF 600000	Set K-Factor (pulses per unit volume) from Flow Sensor manual. Min: 0.0001, max 999999. Cannot be zero. Default = 60.0000.
TF 1000	Sets the volume of each count of the Totalizer as a multiple of the volume unit of the K-Factor. Min: 0.0001, max 999999. Cannot be zero. Default = 1.0000.
RATE CAL	Select to calibrate using Rate method (see Appendix).
VOLUME CAL	Select to calibrate using Volume method (see Appendix).
LAST CAL MM-DD-YYYY II	Enter date of calibration (mm-dd-yyyy) and initials of calibrator (ii).

28. Sensor-Specific Menus

Flow - continued

INPUT Menu

	If desired, a custom name can be entered. Enter 13-character string. Default = FLOW.
	If your flow sensor is configured for frequency output, select FREQ. If configured for Digital (S ³ L) output (recommended), select S ³ L. Default = FREQ.
	Set the units of measure. The last character sets the timebase: S (seconds) M (minutes) H (hours) D (days). Default = GPM.
	Identifies the Totalizer units. It has no effect on any calculation. Default = GALLONS.
	Dampens display, output and relay response rates. Select Low, Med, High, OFF (See discussion in Appendix). Default = OFF.
	Acts as a threshold for flow measurement response. A lower sensitivity setting gives a fast measurement response, a higher setting gives a slower response. Value expressed in units of measurement; response dependent on units of measurement being exceeded. (See discussion in Appendix.)

28. Sensor-Specific Menus

pH



This is the normal display and does not time out.

pH Setup Checklist

1. Make sure pH sensor type is selected (see System Setup Menu, page 36).
2. Set the Temperature Units ($^{\circ}\text{C}$ or $^{\circ}\text{F}$).
3. If LOOP is used, set the minimum and maximum 4 to 20 mA setpoints.
4. Perform calibration (EasyCal, Standard or Standard and Slope).
5. Set Last Cal Date and initials.
6. Select source for Open Collector and Relay output (pH or Temp).
7. If desired, set up relay functions for your own application.

VIEW Mode Menu

TEMP ----- $^{\circ}\text{C}$	Displays temperature at the sensor.
RAW ----- mV	Displays the millivolt input from the electrode. Use this display to determine the relative condition of your electrode during periodic calibration. (7 pH buffer = 0 mV, ± 50 mV)
LOOP 1 720 mA	Displays the 4 to 20 mA LOOP1 output.
RLYS 1 2 3 OFF OFF OFF	Bottom line shows one of three states (OFF, ON, PLS) for each of the three relays. Displays remaining time for CYC LOW or CYC HIGH mode. The relay(s) will remain ON while counting down. NOTE: To reset the timer: In the RELAY menu, select TEST RELAY function. The timer will reset to 0 if the condition no longer exists when the TEST is performed. The timer will restart if the condition still exists.

INPUT Menu

NAME MEAS TYPE PH	Enter string up to 13 characters (optional). Default = MEAS TYPE PH.
$^{\circ}\text{C}$ TEMP UNITS	Select $^{\circ}\text{F}$ or $^{\circ}\text{C}$. Default = $^{\circ}\text{C}$.
AVERAGE OFF	Dampens display, output and relay response rates. Select Low, Med, High, OFF (see discussion in Appendix). Default = OFF. NOTE: Omega strongly recommends leaving averaging OFF for pH and Pressure measurements (see discussion in Appendix).

28. Sensor-Specific Menus

pH - continued

CAL Menu

<pre>CAL AT INSTRUMENT</pre>	Select AT SENSOR to perform calibration using the PHEH-275 sensor electronics. Select AT INSTRUMENT to perform calibration at the DPU91 via EasyCal or manual calibration. (See pH Calibration procedures in the Appendix.) Default = AT INSTRUMENT.
<pre>NO HOLD OUTPUTS</pre>	YES prevents relays from activating while making adjustments, and relays in PULSE mode will suspend pulsing. Output is held until the user exits the CAL menu. Select YES/NO. Default = NO.
<pre>EASY CAL --)</pre>	Press ► to start the EasyCal process. You will be prompted to enter your password. (See pH EasyCal procedure in the Appendix).
<pre>SET PH STANDARD</pre>	Applies a linear offset to the pH measurement. The ideal value is the average pH of your application. (A sample of your application at process temperature is recommended.) (See pH Calibration procedures in the Appendix.) Shows error message if offset too high.
<pre>SET PH SLOPE</pre>	Applies a slope to the pH measurement. The slope value and the standard value must be at least 2 pH units apart. The ideal values are the minimum and maximum values of your process. (See pH Calibration procedures in the Appendix.) Shows error message if slope is too low or high.
<pre>SET TEMPERATURE</pre>	Applies a linear offset to the temperature measurement. The ideal value is the average temperature of your application. "SAVING" will appear if offset is acceptable, "ERR TOO LARGE TO CALIBRATE" if offset is outside of range.
<pre>RESET PH CAL</pre>	Press ► to reset pH Calibration to factory default.
<pre>SET TEMP CAL</pre>	Press ► to reset temperature calibration to factory default.
<pre>LAST CAL MM-DD-YYYY II</pre>	Enter date of calibration (mm-dd-yyyy) and initials of calibrator (ii).



NOTE: If CAL AT SENSOR is selected, the only screens shown will be CAL, HOLD OUTPUTS, and LAST CAL DATE.

28. Sensor-Specific Menus

ORP



This is the normal display and does not time out.

ORP Setup Checklist

1. Make sure ORP sensor type is selected (see System Setup Menu, page 36).
2. If LOOP is used, set the minimum and maximum 4 to 20 mA setpoints.
3. Set Averaging.
4. Perform calibration or set Standard (and Slope if desired).
5. Set Last Cal Date and initials.
6. If desired, set up relay functions for your own application.

VIEW Mode Menu

`RAW` ----- `mV` Displays the millivolt input from the electrode. Use this display to determine the relative condition of your electrode during periodic calibration.

`LOOP 1` `720` `mA` Displays the 4 to 20 mA LOOP1 output

`RLYS`
`1 2 3`
`OFF OFF OFF` Bottom line shows one of three states (OFF, ON, PLS) for each of the three relays. Displays remaining time for CYC LOW or CYC HIGH mode. The relay(s) will remain ON while counting down.
NOTE: To reset the timer: In the RELAY menu, select TEST RELAY function. The timer will reset to 0 if the condition no longer exists when the TEST is performed. The timer will restart if the condition still exists.

INPUT Menu

`NAME`
`ORP` Enter string up to 13 characters (optional). Default = ORP.

`AVERAGE` `OFF` Dampens display, output and relay response rates. Select Low, Med, High, OFF. (See discussion in Appendix.) Default = OFF.

28. Sensor-Specific Menus

ORP - continued

CAL Menu

<pre>CAL AT INSTRUMENT</pre>	Select AT SENSOR to perform calibration using the PHEH-275 sensor electronics. Select AT INSTRUMENT to perform calibration at the DPU91 via EasyCal or manual calibration. (See pH Calibration procedures in the Appendix.) Default = AT INSTRUMENT.
<pre>NO HOLD OUTPUTS</pre>	YES prevents relays from activating while making adjustments, and relays in PULSE mode will suspend pulsing. Output is held until the user exits the CAL menu. Select YES/NO. Default = NO.
<pre>EASY CAL -></pre>	Press ► to start the EasyCal process. You will be prompted to enter your password. (See ORP EasyCal procedure in the Appendix).
<pre>SET ORP STANDARD</pre>	Applies a linear offset to the ORP measurement. For single point calibrations, assign the average value of your process to ORP STANDARD. For two-point calibrations, assign the min or max value of your process to ORP STANDARD (See ORP Calibration procedures in the Appendix).
<pre>SET ORP SLOPE</pre>	Applies a slope to the ORP measurement. The ORP SLOPE is used for two-point calibration along with the ORP STANDARD. If you applied the min value of your process to the ORP STANDARD, then apply the max value to the ORP SLOPE. Else, apply the min value to the ORP SLOPE. The slope value and the standard value must be at least 30 mV apart. (See pH Calibration procedures in the Appendix.)
<pre>RESET ORP CAL</pre>	Resets calibration to factory settings. After pressing ►, select YES/NO. (Shown if CAL AT INSTR)
<pre>LAST CAL MM-DD-YYYY II</pre>	Enter date of calibration (mm-dd-yyyy) and initials of calibrator (ii).

28. Sensor-Specific Menus

Conductivity / Resistivity



This is the normal display and does not time out.

Cond/Res Setup Checklist

1. Make sure COND/RES sensor type is selected (see System Setup Menu, page 36).
2. Set Cell Constant.
3. Set the Temperature Units ($^{\circ}\text{C}$ or $^{\circ}\text{F}$).
4. Set Conductivity units.
5. If LOOP is used, set the minimum and maximum 4 to 20 mA setpoints.
6. Set Temperature Compensation.
7. Set Last Cal Date and initials.
8. Select source for Open Collector and Relay output (COND or TEMP).
9. If desired, setup relay functions for your own application.

VIEW Mode Menu

TEMP ----- mV

Same as above with temperature, does not time out.

LOOP1 720 mA

Displays the 4 to 20 mA LOOP1 output.

RLYS
1 2 3
OFF OFF OFF

Bottom line shows one of three states (OFF, ON, PLS) for each of the three relays. Displays remaining time for CYC LOW or CYC HIGH mode. The relay(s) will remain ON while counting down.

NOTE: To reset the timer: In the RELAY menu, select TEST RELAY function. The timer will reset to 0 if the condition no longer exists when the TEST is performed. The timer will restart if the condition still exists.

CAL Menu

NO
HOLD OUTPUTS

YES prevents relays from activating while making adjustments, and relays in PULSE mode will suspend pulsing. Output is held until the user exits the CAL menu. Select YES/NO. Default = NO.

AUTO CAL

Shows real-time value and selected standard. "PLACE SENSOR IN STANDARD". Unit waits until reading is stable; if bad cal, returns "ERROR, CANNOT DETERMINE STANDARD". Refer to buffer values and AUTO CAL Procedure in the Appendix.

MANUAL CAL

Shows "CONDUCTIVITY" on bottom line; when user presses any button the live value is frozen and the user edits that value. If bad cal, returns "ERR TOO LARGE TO CALIBRATE". See Manual Cal procedure in Appendix.

SET
TEMPERATURE

Shows "TEMPERATURE" on bottom line; when user presses any button the live value is frozen and the user edits that value. If bad cal, returns "ERR TOO LARGE TO CALIBRATE".

RESET CONDCAL

Resets Conductivity calibration. After pressing ►, select YES/NO.

RESET TEMP CAL

Resets Temperature calibration. After pressing ►, select YES/NO.









LAST
CAL
MM-DD-YYYY II

Enter date of calibration (mm-dd-yyyy) and initials of calibrator (II).

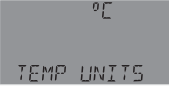
28. Sensor-Specific Menus

Conductivity / Resistivity - continued

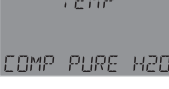
INPUT Menu

	Enter string up to 13 characters (optional). Default = COND/RES
	Enter cell constant of sensor. Select 20.0, 10.0, 1.0, 0.1, 0.01, or CUSTOM. Default = 1.0 (See NOTE below)
	Enter the precise cell constant from the certificate provided with your sensor, or from the information label on the sensor. Shown if CELL CONSTANT = CUSTOM. (See NOTE below)
	Select °C, °F. Default = °C
	Select μS, mS, PPM, PPB, KOhm, or MOhm. Default = μS. NOTE: In USP Relay Mode, TEMP COMP must be set to NONE and Unit Of Measure must be set to μS.
	If the COND UNITS selection is PPM or PPB, set the ratio of Total Dissolved Solids to μS. Default = 0.50
	Dampens display, output and relay response rates. Select Low, Med, High, or OFF. (See discussion in Appendix) Default = OFF
	Select temperature compensation (NONE, LINEAR, PURE H2O). Default = LINEAR. NOTE: In USP Relay Mode in Conductivity, Relay Source must be set to COND, TEMP COMP must be set to NONE and Unit Of Measure must be set to μS.
	For LINEAR or PURE H2O temperature compensation, select a % per °C slope. Maximum slope setting is 9.99 % per °C. Default = 2.0. (If Temperature Compensation setting is NONE, this item will not be displayed)

Factory-Set Span:

0.01 cell (CDCE-90-001, CDE-2851)	0 to 100 μS
0.10 cell (CDCE-90-01, CDE-2852)	0 to 1000 μS
1.0 cell (CDCE-90-1, CDE-2853)	0 to 10,000 μS
10.0 cell (CDCE-90-10, CDE-2854)	0 to 200,000 μS
20.0 cell (CDCE-90-20B)	0 to 400,000 μS

NOTE:

If using a CDTX-2850 Conductivity/Resistivity Sensor Electronics in conjunction with your DPU91, the CDTX-2850 must be set for the custom cell constant or the actual probe cell constant and the DPU91 set for a 1.0 cell constant.

28. Sensor-Specific Menus

Salinity



This is the normal display and does not time out.

SALINITY Setup Checklist

1. Make sure SALINITY sensor type is selected (see System Setup Menu, page 36).
2. Set Cell Constant.
3. Set the Temperature Units ($^{\circ}\text{C}$ or $^{\circ}\text{F}$).
4. If LOOP is used, set the minimum and maximum 4 to 20 mA setpoints.
5. Set Last Cal Date and initials.
6. Select source for Open Collector and Relay output (SAL or TEMP).
7. If desired, set up relay functions for your own application.

VIEW Mode Menu

TEMP 00000 $^{\circ}\text{C}$

Displays temperature at the sensor.

LOOP1 720 mA

Displays the 4 to 20 mA LOOP1 output.

COND 00000 mS

Displays the equivalent conductivity value in milliSiemens.

RLYS
1 2 3
OFF OFF OFF

Bottom line shows one of three states (OFF, ON, PLS) for each of the three relays. Displays remaining time for CYC LOW or CYC HIGH mode.

The relay(s) will remain ON while counting down.

NOTE: To reset the timer: In the RELAY menu, select TEST RELAY function. The timer will reset to 0 if the condition no longer exists when the TEST is performed. The timer will restart if the condition still exists.

CAL Menu

NO
HOLD OUTPUTS

YES prevents relays from activating while making adjustments, and relays in PULSE mode will suspend pulsing. Output is held until the user exits the CAL menu. Select YES/NO. Default = NO.

SET
SALINITY

Manually set salinity value to match to a known standard (external reference).

SET
TEMPERATURE

Provides a maximum 20°C offset to match to a known standard (external reference).

RESET SAL CAL

Resets Salinity calibration to factory settings. After pressing \blacktriangleright , select YES/NO.

RESET TEMP CAL

Resets Temperature calibration to factory settings. After pressing \blacktriangleright , select YES/NO.

LAST
CAL
MM-DD-YYYY II

Enter date of calibration (mm-dd-yyyy) and initials of calibrator (II).

28. Sensor-Specific Menus

Conductivity / Resistivity - continued

INPUT Menu

NAME
SALINITY

Enter string up to 13 characters (optional). Default = SALINITY.

200
CELL CONSTANT

Enter cell constant of sensor. Select 20.0, 10.0, 1.0 or CUSTOM.
Default = 20.

CUST
CELL [] [] [] [] [] [] [] [] [] [] [] [] [] []

Enter the precise cell constant from the certificate provided with your sensor, or from the information label on the sensor.
Shown if CELL CONSTANT = CUSTOM.

°C
TEMP UNITS

Select °C or °F.
Default = °C.

AVERAGE OFF

Dampens display, output and relay response rates.
Select Low, Med, High, OFF. (See discussion in Appendix.)
Default = OFF.

TEMP
COMP LINEAR

Select temperature compensation (NONE, LINEAR).
Default = LINEAR.

%
200
REL TEMP COMP

For LINEAR temperature compensation, select a % per °C slope.
Maximum slope setting is 9.99 % per °C. (If Temperature Compensation setting is NONE, this item will not be displayed.)

29. Troubleshooting

Condition	Possible Causes	Suggested Solution
Wrong Sensor	Incorrect sensor installed	Connect correct sensor
	Sensor Type set incorrectly in DPU91	Set correct sensor TYPE in INPUT menu (see page 36)
Wrong Code	Wrong password entered	Enter correct password (see page 38)
K-Factor Out Of Range	K-Factors cannot be set to 0	Enter K-Factor from 0.0001 to 99999
Backlight inoperative	DPU91 operating on loop power	Connect DPU91 to 10.8 to 35.2 VDC power.
	Backlight turned OFF (NOTE: Backlight can turn off automatically in AUTO mode.)	Set BACKLIGHT to LOW, HIGH or AUTO in OPTION menu.
Relays 2 and 3 inoperative	DPU91 operating on loop power	Connect DPU91 to 10.8 to 35.2 VDC power.
	Relay Module installed incorrectly	Remove and reseat relay module
	Wrong settings in RELAY menu	Use test relay to verify relay operation then check relay settings
Relay LEDs inoperative	DPU91 operating in Loop Power	Use DC power. Check relay states in VIEW mode for status.
Open Collector (R1) or Relay (R2 or R3) always on	Hysteresis value too large	Change the hysteresis value
	Defective Relay Module	Replace Relay Module
OVR relay state (Pulse Overrun)	Relay pulse rate exceeds maximum of 300 pulses per minute	Increase volume pulse setting
		Reduce system flow rate
	Pulse width set too wide	Decrease pulse width
	(NOTE: Max pulse rate = 300; max pulse width = 100 mS.	
- - - - -	Flow rate exceeds display capability	Increase Flow units time base
		Change unit of measure
Check Sensor	DPU91 cannot "talk" to sensor	Check wiring Replace sensor
	(pH/ORP, Cond/Res, Sal) Missing sensor or bad temperature element	Install or replace sensor
Check Preamp	DPU91 cannot "talk" to preamp	Check wiring or replace preamp
Warning LED lit	Look for error message	Correct error condition
Missing Cap	Dissolved Oxygen sensor is missing the sensor cap	Reinstall Dissolved Oxygen sensor cap
Replace Cap	Dissolved Oxygen sensor cap has expired	Install new Dissolved Oxygen sensor cap

30. Appendix

31. Averaging

■ ■ ■ ■ ■ NO AVERAGING, NO SENSITIVITY

With SENSITIVITY set to 0 (zero) and AVERAGING set to OFF (0 seconds), the DPU91 responds immediately to every shift in the process. The dashed red line represents the actual output of the sensor in varying conditions.

■■■■■■■■■■ AVERAGING ONLY

With SENSITIVITY still set to zero and AVERAGING set to MED or HIGH the rate is stabilized, but a sharp change in rate is not represented for 8 to 32 seconds or longer.

■■■■■■■■■■ AVERAGING AND SENSITIVITY

With SENSITIVITY at 50 and AVERAGING set to MED or HIGH, the rate is stabilized, while the sudden shift in process is reflected very quickly.

NOTE: The SENSITIVITY function applies only to FLOW. The SENSITIVITY function has no effect if the AVERAGING function is set to OFF.

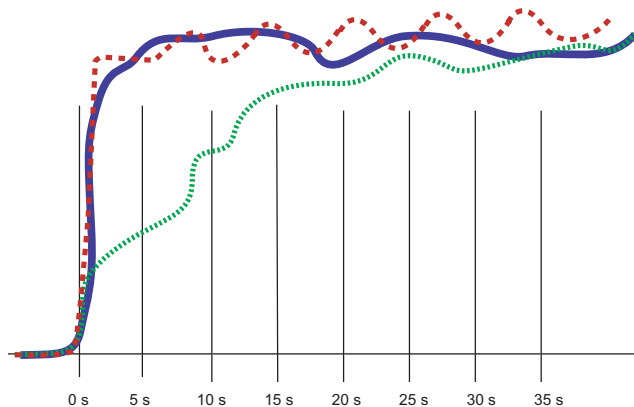

Averaging is different depending on the measurement type. Seconds to 99.5% of Final Value for Low, Med, and High are:

Sensor Type	Low	Medium	High
Flow	10	40	120
pH	2	4	12
ORP	2	4	12
Cond/Res	4	6	12
Salinity	4	6	12

32. LOG Current Loop Output

In Conductivity/Resistivity, the logarithmic (LOG) mode can be used when a very large measurement range is required, yet high resolution is needed at the low end, e.g., in a clean-in-place application where a high-resolution conductivity reading is needed at the low end while a very high conductivity reading is needed when a cleaning cycle is in progress.

Only two parameters need to be set up, the starting or base conductivity value (4 mA SETPNT) and the ending or maximum conductivity value (20 mA SETPNT). The 4 mA setpoint may be larger than the 20 mA point (reverse span).

What equation should be put in the PLC?

$$\text{Conductivity} = 0 \times (\text{mA input} - 4) \times \frac{(\text{Log}_{10} 20 \text{ mA setpnt} - \text{Log}_{10} 4 \text{ mA setpnt})}{16} + \text{Log}_{10} 4 \text{ mA setpnt}$$

If only fixed thresholds are of interest, they can be calculated in mA and then the mA value can be checked directly. Inside the DPU91 the following equation is used:

$$\text{mA} = \frac{(\text{Log}_{10} \text{Conductivity} - \text{Log}_{10} 4 \text{ mA setpnt})}{(\text{Log}_{10} 20 \text{ mA setpnt} - \text{Log}_{10} 4 \text{ mA setpnt})} \times 16 + 4$$

NOTE :

If ADJUST 4 mA or ADJUST 20 mA is used, the mA value can be affected.

To prevent any problems the adjust function should only be used to get exactly 4.0 and 20.0 at the PLC.

The DPU91 is accurate and the adjust functions are only needed to compensate for an offset due to noise or a not-so-accurate PLC input card.

The error value of either 3.6 mA or 22 mA should be tested first before applying the conductivity equation.

33. Calibration Procedures: pH



EasyCal Procedure - pH

EasyCal is the fastest and simplest periodic calibration method. Requires prepared 4, 7 or 10 pH buffers (any two).

To Calibrate:

Place electrode tip in first pH buffer.

pH 4.0 = 177 mV
pH 7.0 = 0 mV
pH 10 = -177 mV
Limit ± 50 mV

Response:

30s

Allow for stabilization
30 seconds

To Accept:

ENTER to accept

Place electrode tip in second pH buffer.

30s

Allow for stabilization
30 seconds

ENTER to accept second buffer calibration

To exit menus and return to VIEW press ▲ and ▼ buttons at the same time.



Display returns to VIEW Mode in 10 minutes



- This procedure simplifies pH calibration using standard 4.0, 7.0, 10.0 pH buffers only. If these pH buffers are not available, use MANUAL CAL and calibrate the system using the STANDARD and SLOPE settings.
- Set sensor temperature in the CAL Mode before performing EasyCal for new electrode installations.

Theoretical mV values

pH @ 25 °C	mV
2	+296
3	+237
4	+177
5	+118
6	+59
7	+0
8	-59
9	-118
10	-177
11	-237
12	-296



NOTE:

The solutions can be used for calibrating more than one sensor; however, the solution must remain free of debris and must not be diluted by rinse water from previous calibrations.

33. Calibration Procedures: pH - continued

Manual Calibration Procedure - pH

Requires prepared buffers. System calibration is possible with two known pH solutions within 0 to 14 pH (buffers of pH 4.01, 7, or 10 are recommended, but use a buffer close to your own process value.)

To Calibrate:

Place electrode tip in pH buffer.

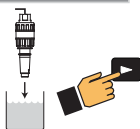

30s
Allow for stabilization 30 seconds to several minutes



To Change Reading:

to accept



To Set Slope:

Place electrode tip in pH buffer two pH units different than standard.

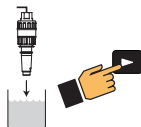

30s
Allow for stabilization 30 seconds to several minutes



To Change Reading:

to accept



To Set Calibration Date:



Display returns to VIEW Mode

Single-point calibration sets STANDARD only; Omega recommends a two-point calibration to set SLOPE in addition to STANDARD.

Quick Manual Calibration Procedures:

1-Point Calibration:

1. Set solution standard.

2-Point Calibration (recommended):

1. Set solution standard.
2. Set solution slope.

34. Calibration Procedures: ORP



EasyCal Procedure - ORP

EasyCal is the fastest and simplest periodic calibration method.

Requires a prepared quinhydrone solution:

Saturate 50 mL of pH 4 and 7 buffers with 1/8 g quinhydrone.

To Calibrate:



Place electrode tip in saturated pH 7.0 buffer. pH 7.0 = 87 mV



Response:



Allow for stabilization 30 seconds

To Accept:



to accept



Place electrode tip in saturated pH 4.0 buffer. pH 4.0 = 264 mV



Allow for stabilization 30 seconds



to accept second buffer calibration

To exit menus and return to VIEW press ▲ and ▼ buttons at the same time.



Display returns to VIEW Mode in 10 minutes



NOTE:

ORP solutions made with quinhydrone are very unstable and may not read properly once exposed to air for a prolonged time.

These solutions must be disposed of within an hour.

The solution can be used for calibrating more than one sensor.

However, the solution must remain free of debris and must not be diluted by rinse water from previous calibrations.

Acceptable ranges for the readings are ± 80 mV (i.e., 87 ± 80 mV).

34. Calibration Procedures: ORP - continued

Manual Calibration Procedure - ORP

Requires prepared buffers and a prepared quinhydrone solution:
Saturate 50 mL of pH 4 and 7 buffers with 1/8 g quinhydrone.

(System calibration is possible with two known ORP solutions, but use a buffer close to your own process value).

To Calibrate:

Place electrode tip in saturated pH 7.0 buffer. pH 7.0 = 87 mV

To Change Reading:

30s
Allow for stabilization 30 seconds to several minutes

to accept

To Set Slope:

Place electrode tip in saturated pH buffer two pH units different than standard. pH 4.0 = 264 mV

To Change Reading:

30s
Allow for stabilization 30 seconds to several minutes

to accept

To Set Calibration Date:

Display returns to VIEW Mode

Single-point calibration sets STANDARD only;
Omega recommends a two-point calibration to set SLOPE in addition to STANDARD.

Quick Manual Calibration Procedures:

1-Point Calibration:

1. Set solution standard.

2-Point Calibration (recommended):

1. Set solution standard.
2. Set solution slope.

35. Calibration Procedures: Conductivity/Resistivity



Calibration Procedure - Conductivity/Resistivity

AutoCal is the fastest and simplest periodic calibration method.
Requires prepared buffer of a value appropriate to your process.

AutoCal Procedure

AutoCal is a single-point calibration system. During this procedure, if the measured value is within $\pm 10\%$ of any of the test values listed below, the DPU91 will automatically recognize the test value and calibrate the output to that value.

NOTE: The first step (Reset) is recommended each time an electrode is replaced, but is NOT necessary upon initial installation or periodic calibration.

NOTE: Ensure that the buffer solution is within $\pm 5^\circ\text{C}$ of 25°C .

1. Reset the sensor to factory calibration (refer to sensor manual for procedure).
2. On the DPU91, select AUTO CAL from the CAL menu. Press ►.
3. Place the electrode/sensor assembly into the conductivity test solution appropriate to your operating range. Shake the electrode to dislodge any air bubbles visible on the surface of the electrode.
4. Allow at least 2 minutes for the electrode response to stabilize.
5. When the display stabilizes, press ENTER.
6. If calibration is successful, the DPU91 will display "SAVING". If error is too large, "OUT OF RANGE USE MANUAL CALIBRATION" will display.

Calibration is complete. Return the system to service.

Conductivity units are displayed as selected in the CALIBRATE menu.
Resistivity displayed when $\text{K}\Omega$ or $\text{M}\Omega$ ranges are selected.

Manual Cal Procedure

NOTE: The first step (Reset) is recommended each time an electrode is replaced, but is NOT necessary upon initial installation or periodic calibration.

NOTE: Ensure that the buffer solution is within $\pm 5^\circ\text{C}$ of 25°C .

1. Reset the sensor to factory calibration (refer to sensor manual for procedure).
2. On the DPU91, select MANUAL CAL from the CAL menu. Press ►.
3. Place the electrode/sensor assembly into the conductivity test solution appropriate to your operating range. Shake the electrode to dislodge any air bubbles visible on the surface of the electrode.
4. Allow at least 2 minutes for the electrode response to stabilize.
5. When the display stabilizes, enter the value of the buffer solution using the ▼, ▲ and ► buttons.
6. Press ENTER.
7. DPU91 will display "SAVING". If error is too large, "ERR TOO LARGE TO CALIBRATE" will display.

Calibration is complete. Return the system to service.

Available buffer values:

- 10
- 100
- 146.93
- 200
- 500
- 1000
- 1408.8
- 5000
- 10,000
- 12856
- 50,000
- 100,000

(all values in μS)

36. Calibration Procedures: Flow

Calibration Procedure - Flow

Select RATE CALIBRATION to match the dynamic flow rate to an external reference. Entering a rate will modify the existing K-Factor.

Select VOLUME CALIBRATION if the flow rate can be determined by filling a vessel of known volume. The DPU91 will count the number of pulses generated as the known volume of fluid passes through the sensor, and then use the information to calculate a new K-Factor.

Rate Calibration Procedure

1. Use ▲, ▼ and ► to set the flow rate in the flashing display to match the reference meter. Press ENTER when completed.
2. The DPU91 displays the newly calculated K-Factor for your reference.
If the calculated K-Factor is less than 0.0001 or greater than 999999 (out of range at either extreme), the DPU91 displays "ERROR NEW KF OUT OF RANGE" and returns to RATE CAL.
If flow is too low to accurately calibrate, the DPU91 displays "ERROR FLOW RATE TOO LOW" and returns to RATE CAL.
3. Press ENTER to accept the new K-Factor (DPU91 displays "SAVING") or press ▲+▼ keys simultaneously to escape without saving and return to Enter Volume.

NOTE:

You may enter your own calculated K-Factor in the INPUT menu.



GPM
0.0000
SET FLOW



KF 600000

Volume Calibration Procedure

1. Press ENTER to start the volumetric calibration period. The DPU91 starts counting pulses from the flow sensor.
2. Press ENTER to stop the volumetric calibration period. The DPU91 stops counting pulses from the flow sensor.
3. Enter the volume of fluid known to have flowed past the sensor during the volumetric calibration period. This will modify the existing Flow K-Factor.
4. The DPU91 displays the newly calculated K-Factor for your reference.
If the calculated K-Factor is less than 0.0001 or greater than 999999 (out of range at either extreme), the DPU91 displays "ERROR VOLUME TOO HIGH" (or LOW) and returns to VOLUME CAL.
5. Press ENTER to accept the new K-Factor (DPU91 displays "SAVING") or press ▲+▼ keys simultaneously to escape without saving and return to Enter Volume.

NOTE:

You may enter your own calculated K-Factor in the INPUT menu.



START (ENTER)



Run
STOP (ENTER)



G
0.0000
ENTER VOLUME



KF 600000

37. Calibration Error Messages

Message	Cause	Solution
Out Of Range Use Manual Calibration	(Cond/Res) Error > 10% in AutoCal	Use manual calibration method
	(pH) Buffer not found; Error > ± 1.5 pH units	Use 4, 7, 10 pH buffers (with quinhydrone for ORP calibration) Clean sensor and retry EasyCal
	(ORP) No quinhydrone in buffer Error greater than ± 80 mV	Use manual calibration method
Err Too Large To Calibrate	(Cond/Res) Manual cal when error > 100%	Inspect sensor and wiring for damage Clean sensor
	(pH) Offset > 1.3 pH units; Slope error > 100%	Check reference Clean sensor Replace sensor
	(Press) Slope must be < $\pm 50\%$ or offset must be < 2.75 PSI or equivalent.	
	(Sal) Slope error > 1000%	
Error Volume Too Low	User-entered volume too small to calibrate	Correct volume entry Use longer calibration period
Error New KF Out Of Range	The calculated K-Factor too low or high	Verify volume or rate entered Verify flow is present
Error Flow Rate Too Low	(Rate Cal) Flow too low to accurately calibrate	Increase flow
Cal Error Out Of Range	(4 to 20 mA) Slope error > 1000%	Check input at 4 mA and 20 mA settings
	(Temp) Offset must be < ± 20 °C or equivalent.	Check sensor range Check reference Replace sensor
Slope Too Close To Standard	(4 to 20 mA) Difference in calibration values must be > 0.1 units	Check sensor Use fresh buffer Use two different buffer values Clean sensor
	(pH) Difference in calibration values must be > 2 pH units	
	(ORP) Difference in calibration values must be > 30 mV	
Standard Too Close To Slope	(4 to 20 mA) Difference in calibration values must be > 0.1 units	Clean sensor Use fresh 4, 7, 10 pH buffers Use two different buffer values
	(pH) Difference in calibration values must be > 2 pH units	
	(ORP) Difference in calibration values must be > 30 mV	
Level Offset Too Large	Offset must be < 1.0 meter	Decrease offset Replace sensor
Pressure Too High	Pressure must be lower than 2.5 PSI or equivalent to do zero cal.	Decrease pressure
Pressure Too Close To Zero	Pressure must be higher than 3 PSI or equivalent to do slope calibration.	Increase pressure Check reference

38. USP Limits

USP (United States Pharmacopoeia) has defined a set of conductivity values (limits) to be used for pharmaceutical water. The standard requires that conductivity measurement without temperature compensation be used for these applications.

The limits vary according to the temperature of the sample. The DPU91 has the USP limits stored in memory. It will automatically determine the proper USP limit based on the measured temperature.

Using the USP function

USP setpoints are defined as a percentage below the USP limit, so a USP alarm is always a HIGH alarm.

The DPU91 can be set to warn you if the conductivity approaches within a set percentage of the USP limit.

The following settings and conditions are required for a USP relay function:

1. In the RELAY menu:
 - RELAY MODE must be set to **USP**.
2. In the INPUT menu:
 - COND UNITS must be set to **µS**.
 - TEMP COMP must be set to **None**.

Example:

- The water temperature is 19 °C, so the USP limit is 1.0 µS.
- The USP PERCNT is set to 40%.
- The relay will be activated when the conductivity value reaches 40% below the 1.0 USP limit, or 0.6 µS.
- If the water temperature drifts to more than 20 °C, the DPU91 will automatically adjust the USP limit to 1.1. The relay will now be activated when the conductivity value reaches 40% below 1.1 µS (0.66 µS).

Temperature Range (°C)	USP limit (µS)
0 to < 5	0.6
5 to < 10	0.8
10 to < 15	0.9
15 to < 20	1.0
20 to < 25	1.1
25 to < 30	1.3
30 to < 35	1.4
35 to < 40	1.5
40 to < 45	1.7
45 to < 50	1.8
50 to < 55	1.9
55 to < 60	2.1
60 to < 65	2.2
65 to < 70	2.4
70 to < 75	2.5
75 to < 80	2.7
80 to < 85	2.7
85 to < 90	2.7
90 to < 95	2.7
95 to < 100	2.9
100 to < 105	3.1

39. Maintenance

- Clean the instrument case and front panel with a soft cotton cloth dampened with a mild liquid soap solution.
- Never wipe the front window with static retentive cloths such as wool or polyester which may induce a static charge. If a static charge develops on the window, you may notice temporary blotches form on the screen. When this occurs, clean the front window with an anti-static cloth, or a soft cotton cloth and anti-static spray or a mild liquid soap solution to remove the static charge.

40. Specifications

General

Input channelsOne

Enclosure and Display

Case MaterialPBT

WindowShatter-resistant glass

Keypad4 buttons, injection-molded silicone rubber seal

DisplayBacklit, 7- and 14-segment

Indicators“Dial-type” digital bar graph

Update rate1 s

LCD Contrast5 settings

Enclosure

Size¼ DIN

ColorBlack (Panel Mount),
Yellow and black (Integral Mount)

Mounting

Panel¼ DIN, ribbed on four sides for panel mounting clip inside panel,
silicon gasket included

FieldMounts to standard Omega field mount junction boxes.
Optional angle adjustment adapter is available

WallLarge enclosure (sold as an accessory) that encases the panel
mount transmitter

Terminal Blocks

Pluggable screw type: use minimum 105 °C rated wire

Torque ratings

Cond/Res, Open Collector,

Power/Loop0.33 Nm (3.0 lb-in.)

Freq/S3L0.24 Nm (2.2 lb-in.)

Relay0.49 Nm (4.4 lb-in.)

Connector wire gauge

Power, Loop12 to 28 AWG

Open Collector12 to 28 AWG

Freq/S3L16 to 28 AWG

Module connector wire gauge

Relay12 to 28 AWG

Cond/Res16 to 28 AWG

Batchup to 14 AWG

Environmental Requirements

Ambient operating temperature:

Backlit LCD -10 °C to 70 °C (14 °F to 158 °F)

Storage Temp -15 °C to 70 °C (5 °F to 158 °F)

Relative Humidity 0 to 100% condensing for Field and Panel Mount (front only);
0 to 95% non-condensing for Panel Mount back side.

Maximum Altitude 4,000 m (13,123 ft); use only DC power supply to maintain
UL safety standard up to this altitude

Enclosure Rating Designed to meet NEMA 4X/IP65 (front face only on panel
mount; field mount is 100% NEMA 4X/IP65).

Installation Category Cat II

Pollution Degree 2

40. Specifications - continued

Performance Specifications

System Accuracy

- Primarily dependent upon the sensor.

System Response

- Primarily dependent upon the sensor.
Controller adds a maximum of 150 ms processing delay to the sensor electronics.
- Minimum update period is 100 ms
- System response is tempered by the display rate, output averaging and sensitivity feature.

Electrical Requirements

Power to Sensors

Voltage..... +4.9 to 5.5 VDC @ 25 °C, regulated

Current..... 1.5 mA max in loop power mode;
20 mA max when using DC power

Short Circuit..... Protected

Isolation Low voltage (< 48 V AC/DC) to loop with DC power connected

No isolation when using loop power only

Input Power Requirements

DC (preferred) 24 VDC; input range: 10.8 to 35.2 VDC regulated

DPU91 w/o Relay Module ... 200 mA *

DPU91 w/ Relay Module 300 mA *

*The current draw of the other modules and the sensors are minimal

Loop..... 10.8 to 35.2 VDC 4 to 20 mA (30 mA max.)

Overvoltage protection 48 Volt Transient Protection Device (for DC ONLY)

Current limiting for circuit protection

Reverse-Voltage protection

Loop Characteristics

DC Powered System (preferred)

Max. loop impedance:

@ 12 V loop power 250 Ω max.

@ 18 V loop power 500 Ω max.

@ 24 V loop power 750 Ω max.

Loop Powered System

Max. loop impedance:

@ 12 V loop power 50 Ω max.

@ 18 V loop power 325 Ω max.

@ 24 V loop power 600 Ω max.

40. Specifications - continued

Relay Specifications

Hysteresis.....	Adjustable (absolute in Engineering Units)
Latch.....	Reset in test screen only
On Delay.....	9999.9 seconds (max)
Cycle Delay.....	99999 seconds (max)
Test Mode.....	Set On or Off
Maximum Pulse Rate.....	300 pulses/minute
Proportional Pulse.....	400 pulses/minute
Volumetric Pulse Width.....	0.1 to 3200 s
PWM period.....	0.1 to 320 s

Open Collector

Type.....	NPN
Max. Voltage Rating.....	30 VDC
Max. Current Rating.....	50 mA

Dry-Contact Relays

Type.....	SPDT
Form.....	C
Max. Voltage Rating.....	30 VDC or 250 VAC
Max. Current Rating.....	5 A resistive

Shipping Weights

Base Unit.....	0.63 kg (1.38 lb)
DPU90-COMM Module.....	0.16 kg (0.35 lb)
Conductivity Module.....	0.16 kg (0.35 lb)
Relay Module.....	0.19 kg (0.41 lb)
Batch Module.....	0.16 kg (0.35 lb)

Input Types

- Digital (S³L) or AC frequency
- Open collector
- pH/ORP input via the Digital (S³L) output from the PHEH pH/ORP Sensor Electronics
- Raw Conductivity/Resistivity input directly from Omega Conductivity/Resistivity electrodes via DPU90-C Direct Conductivity/Resistivity Module or via the Digital (S³L) output from the CDTX-2850 Conductivity/Resistivity Sensor Electronics

Sensor Types:

Flow, pH/ORP, Conductivity/Resistivity, Salinity

Input Specifications

Digital (S³L)..... Serial ASCII, TTL level, 9600 bps

Frequency Type Sensors:

Sensitivity.....	(for coil type sensors): 80 mV @ 5 Hz, gradually increasing with frequency to 2.5 V
Freq. Range.....	(for square wave type sensors): 0.5 Hz to 1500 Hz @ TTL level input or open collector
Accuracy.....	± 0.5% of reading max error @ 25 °C
Range.....	0.5 to 1500 Hz
Resolution.....	1 µs
Repeatability.....	± 0.2% of reading

Power Supply

Rejection..... No Effect ± 1 µA per volt

Short Circuit..... Protected

Reverse Polarity..... Protected (no isolation when using loop power only)

Update Rate (1/frequency) + 150 ms

40. Specifications - continued

Display Ranges:

pH:	0.00 to 15.00 pH
pH Temp.:	-99 °C to 350 °C (-146 °F to 662 °F)
ORP:	-1999 to 1999.9 mV
Flow Rate:	-9999 to 99999 units per second, minute, hour or day
Totalizer:	0.00 to 99999999 units
Conductivity:	0.0000 to 99999 µS, mS, PPM and PPB (TDS), kΩ, MΩ
Cond. Temp.:	-99 °C to 350 °C (-146 °F to 662 °F)
Temperature:	-99 °C to 350 °C (-146 °F to 662 °F)
Pressure:	-40 to 1000 psi
Level:	-9999 to 99999 m, cm, ft, in, %
Volume:	0 to 99999 cm ³ , m ³ , in ³ , ft ³ , gal, L, lb, kg, %
Salinity:	0 to 100 PPT
Dissolved O ₂ :	0 to 20 mg/L, 0 to 200%

Output Specifications

Current Loop Out	ANSI-ISA 50.00.01 Class H
Span	3.8 to 21 mA
Zero	4.0 mA factory set; user programmable from 3.8 to 4.2 mA
Full Scale	20.00 mA factory set; user programmable from 19.0 to 21.0 mA
Accuracy	± 32 µA max. error @ 25 °C @ 24 VDC
Resolution	6 µA or better
Temp. Drift	± 1 µA per °C
Pwr Sply Rejection	± 1 µA per V
Isolation	Low voltage (< 48 VAC/DC)
Voltage	10.8 to 35.2 VDC
Max. Impedance:	250 Ω @ 12 VDC 500 Ω @ 18 VDC 750 Ω @ 24 VDC
Update Rate	100 mS nominal
Short circuit and reverse polarity	protected
Adjustable span, reversible	
Error Condition	Selectable error condition 3.6 or 22 mA.
Actual update rate	determined by sensor type
Test Mode:	Increment to desired current (range 3.8 to 21.00 mA)
Open Collector Outputs: 1
Analog Outputs: 1 passive

Current Outputs

- One 4 to 20 mA output
- Linear scaling
- Logarithmic scaling for Conductivity
- Reverse span
- Selectable error mode: 3.6 mA or 22 mA
- Test Output mode that allows the user to test the current output
- Adjustable 4 to 20 mA end points
- HART communication via optional DPU90-COMM Module

41. Ordering Information

DPU91 Transmitter Base Unit:

Single Channel, Multi-Parameter, 4 to 20 mA, Open Collector, DC Power

Mfr. Part No	Description
DPU91P	DPU91 Base Unit, Panel Mount
DPU91	DPU91 Base Unit, Field Mount
DPU91-BC	Batch Controller System

Optional Modules

DPU90-R	Relay Module - 2 DCR (Dry Contact Relays)
DPU90-C	Direct Conductivity/Resistivity Module
DPU90-COMM	COMM Module
DPU90-BCM	Batch Module

Accessories

DPU90-CT	PC COMM Configuration/Diagnostic tool
FP90UM	Universal Mount Kit
FP90RC	RC Filter Kit (for relay use), 2 per kit
FP90IM	Flow Sensor Integral Mounting Kit, NPT, Valox
FP90IM34	3/4 in. Integral Mount Kit
DPU90-WM	Wall Mount Accessory for DPU91
FPM-5000-LTCK	Liquid Tight Connector Kit, NPT (1 pc.)
DPU90-AK	Angle Adjustment Adapter Kit (for Field Mounting)

WARRANTY/DISCLAIMER

OMEGA ENGINEERING, INC. warrants this unit to be free of defects in materials and workmanship for a period of **13 months** from date of purchase. OMEGA's WARRANTY adds an additional one (1) month grace period to the normal **one (1) year product warranty** to cover handling and shipping time. This ensures that OMEGA's customers receive maximum coverage on each product.

If the unit malfunctions, it must be returned to the factory for evaluation. OMEGA's Customer Service Department will issue an Authorized Return (AR) number immediately upon phone or written request. Upon examination by OMEGA, if the unit is found to be defective, it will be repaired or replaced at no charge. OMEGA's WARRANTY does not apply to defects resulting from any action of the purchaser, including but not limited to mishandling, improper interfacing, operation outside of design limits, improper repair, or unauthorized modification. This WARRANTY is VOID if the unit shows evidence of having been tampered with or shows evidence of having been damaged as a result of excessive corrosion; or current, heat, moisture or vibration; improper specification; misapplication; misuse or other operating conditions outside of OMEGA's control. Components in which wear is not warranted, include but are not limited to contact points, fuses, and triacs.

OMEGA is pleased to offer suggestions on the use of its various products. However, OMEGA neither assumes responsibility for any omissions or errors nor assumes liability for any damages that result from the use of its products in accordance with information provided by OMEGA, either verbal or written. OMEGA warrants only that the parts manufactured by the company will be as specified and free of defects. OMEGA MAKES NO OTHER WARRANTIES OR REPRESENTATIONS OF ANY KIND WHATSOEVER, EXPRESSED OR IMPLIED, EXCEPT THAT OF TITLE, AND ALL IMPLIED WARRANTIES INCLUDING ANY WARRANTY OF MERCHANTABILITY AND FITNESS FOR A PARTICULAR PURPOSE ARE HEREBY DISCLAIMED. LIMITATION OF LIABILITY: The remedies of purchaser set forth herein are exclusive, and the total liability of OMEGA with respect to this order, whether based on contract, warranty, negligence, indemnification, strict liability or otherwise, shall not exceed the purchase price of the component upon which liability is based. In no event shall OMEGA be liable for consequential, incidental or special damages.

CONDITIONS: Equipment sold by OMEGA is not intended to be used, nor shall it be used: (1) as a "Basic Component" under 10 CFR 21 (NRC), used in or with any nuclear installation or activity; or (2) in medical applications or used on humans. Should any Product(s) be used in or with any nuclear installation or activity, medical application, used on humans, or misused in any way, OMEGA assumes no responsibility as set forth in our basic WARRANTY/DISCLAIMER language, and, additionally, purchaser will indemnify OMEGA and hold OMEGA harmless from any liability or damage whatsoever arising out of the use of the Product(s) in such a manner.

RETURN REQUESTS/INQUIRIES

Direct all warranty and repair requests/inquiries to the OMEGA Customer Service Department. **BEFORE RETURNING ANY PRODUCT(S) TO OMEGA, PURCHASER MUST OBTAIN AN AUTHORIZED RETURN (AR) NUMBER FROM OMEGA'S CUSTOMER SERVICE DEPARTMENT (IN ORDER TO AVOID PROCESSING DELAYS).** The assigned AR number should then be marked on the outside of the return package and on any correspondence.

The purchaser is responsible for shipping charges, freight, insurance and proper packaging to prevent breakage in transit.

FOR **WARRANTY** RETURNS, please have the following information available BEFORE contacting OMEGA:

1. Purchase Order number under which the product was PURCHASED,
2. Model and serial number of the product under warranty, and
3. Repair instructions and/or specific problems relative to the product.

FOR **NON-WARRANTY** REPAIRS, consult OMEGA for current repair charges. Have the following information available BEFORE contacting OMEGA:

1. Purchase Order number to cover the COST of the repair,
2. Model and serial number of the product, and
3. Repair instructions and/or specific problems relative to the product.

OMEGA's policy is to make running changes, not model changes, whenever an improvement is possible. This affords our customers the latest in technology and engineering.

OMEGA is a registered trademark of OMEGA ENGINEERING, INC.

© Copyright 2016 OMEGA ENGINEERING, INC. All rights reserved. This document may not be copied, photocopied, reproduced, translated, or reduced to any electronic medium or machine-readable form, in whole or in part, without the prior written consent of OMEGA ENGINEERING, INC.

Where Do I Find Everything I Need for Process Measurement and Control? **OMEGA...Of Course!** *Shop online at omega.comSM*

TEMPERATURE

- Thermocouple, RTD & Thermistor Probes, Connectors, Panels & Assemblies
- Wire: Thermocouple, RTD & Thermistor
- Calibrators & Ice Point References
- Recorders, Controllers & Process Monitors
- Infrared Pyrometers

PRESSURE, STRAIN AND FORCE

- Transducers & Strain Gages
- Load Cells & Pressure Gages
- Displacement Transducers
- Instrumentation & Accessories

FLOW/LEVEL

- Rotameters, Gas Mass Flowmeters & Flow Computers
- Air Velocity Indicators
- Turbine/Paddlewheel Systems
- Totalizers & Batch Controllers

pH/CONDUCTIVITY

- pH Electrodes, Testers & Accessories
- Benchtop/Laboratory Meters
- Controllers, Calibrators, Simulators & Pumps
- Industrial pH & Conductivity Equipment

DATA ACQUISITION

- Communications-Based Acquisition Systems
- Data Logging Systems
- Wireless Sensors, Transmitters, & Receivers
- Signal Conditioners
- Data Acquisition Software

HEATERS

- Heating Cable
- Cartridge & Strip Heaters
- Immersion & Band Heaters
- Flexible Heaters
- Laboratory Heaters

ENVIRONMENTAL MONITORING AND CONTROL

- Metering & Control Instrumentation
- Refractometers
- Pumps & Tubing
- Air, Soil & Water Monitors
- Industrial Water & Wastewater Treatment
- pH, Conductivity & Dissolved Oxygen Instruments