



BULLET PROBE/ PIPE MOUNT SERIES

Phone: 1-888-967-5224
Website: workaci.com

Installation & Operation Instructions

PRECAUTIONS

- **DO NOT RUN THE WIRING IN ANY CONDUIT WITH LINE VOLTAGE (24/120/230 VAC).**

GENERAL INFORMATION

The Bullet Probe features a one inch stainless steel probe that is designed for use with electronic controllers in commercial heating and cooling building management systems. It is available with multiple thermistor or RTD options. The bullet style sensor monitors air temperatures and should not be fully submerged in water.

For optimal temperature measurement, follow these tips:

- Do not install on external walls.
- Avoid air registers, diffusers, vents, and windows.
- Eliminate and seal all wall and conduit penetrations. Air migration from wall cavities may alter temperature readings.
- Do not install near heat sources. eg: lamps, radiators, direct sunlight, copiers, chimney walls, walls concealing hot-water pipes.

MOUNTING INSTRUCTIONS

Bullet Probe sensors may be mounted using a 1/4" mounting clip (ACI Item #108169) on walls or with cable ties along pipes. ACI's Pipe mount Series is recommend for pipes from 1/2" (12.7mm) to 1" (25.4mm). The Bullet Probe may still be used, but the Pipe Mount has small curvature on the bottom that is designed to increase the surface area and improve the thermal conductivity between the pipe and the sensor.

BULLET PROBE (-BP) ASSEMBLY ON WALL

Take care when mounting. Check local code for mounting height requirements. The sensor should be mounted in an area where air circulation is well mixed and not blocked by obstructions. To fix the BP on a wall, ACI recommends a height of 48-60" (1.2-1.5 m) off the ground and at least 1.5' (0.5 m) from the adjacent wall. Slide the sensor probe through the mounting clip - see **FIGURE 3** (p. 2). Drill a 1/4" screw through the socket and tighten to the wall.

FIGURE 1: BULLET PROBE (-BP) DIMENSIONS

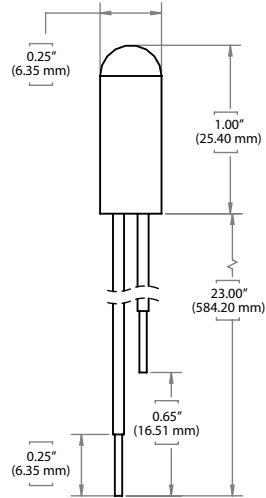
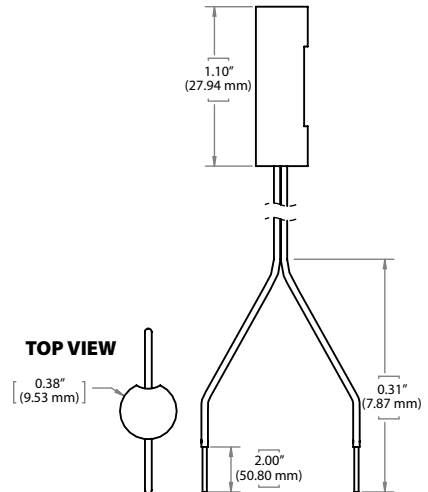

FIGURE 2: PIPE MOUNT (-PM) DIMENSIONS



PIPE MOUNTING

For best accuracy and increased thermal conduction between the pipe and the sensor, ACI recommends to clean the pipe with an emery cloth or file, before applying thermal grease. Be sure to insulate the probe (from the effects of the ambient air) after tightly fastening to the pipe.

BULLET PROBE (-BP) ASSEMBLY ON PIPE

To fix the BP sensor along a pipe, use cable ties to mount the sensor probe and wires on the pipe - see **Figure 4** (middle).

PIPE MOUNT (-PM) ASSEMBLY ON PIPE

For mounting along a small pipe with maximum 1" (25.4 mm) diameter, align the contoured PM sensor to the pipe and fasten with cable ties - see **FIGURE 5** (below).

FIGURE 3: BULLET PROBE

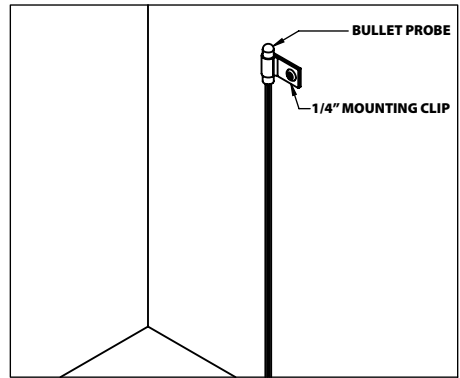

FIGURE 4: BULLET PROBE (-BP) ASSEMBLY

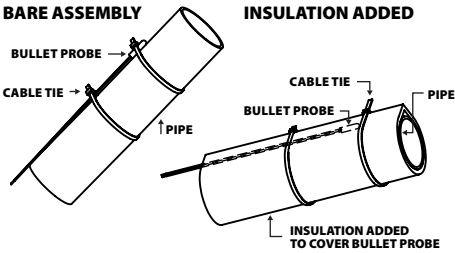
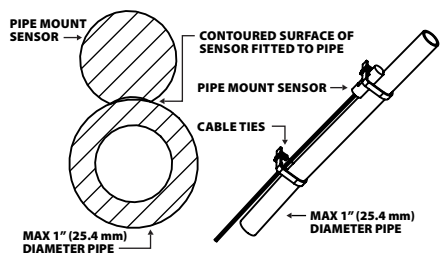

FIGURE 5: PIPE MOUNT (-PM) ASSEMBLY



WIRING INSTRUCTIONS

ACI recommends 16 to 26 AWG twisted pair wires or shielded cables for all sensors. Signal wiring must be run separate from low and high voltage wires (24/120/230 VAC). All ACI thermistors and RTD temperature sensors are both non-polarity and non-position sensitive. All thermistor type units are supplied with (2) flying lead wires, and all RTD's are supplied with (2) or (3) flying lead wires - see **FIGURE 6** (right). The number of wires needed depends on the application.

Connect thermistor/RTD wire leads to controller analog input wires using wire nuts, terminal blocks, or crimp style connectors. All wiring must comply with all local and National Electric Codes.

FIGURE 6: TEMPERATURE WIRING

2-WIRE THERMISTOR or RTD WIRING

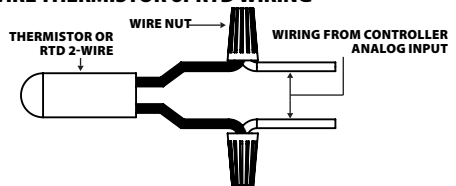

3-WIRE RTD WIRING

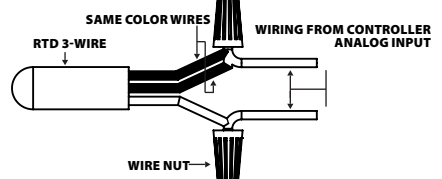

WIRING INSTRUCTIONS (Continued)

Note: When using a shielded cable, be sure to connect only (1) end of the shield to ground at the controller. Connecting both ends of the shield to ground may cause a ground loop. When removing the shield from the sensor end, make sure to properly trim the shield to prevent any chance of shorting.

Note: If the controller requires a (2) wire input for a RTD, connect the (2) common wires(same color) together. If the controller requires (3) wires, use (3) individual wires.

TROUBLESHOOTING

PROBLEM	SOLUTION(S)
Sensor reading is incorrect	<ul style="list-style-type: none">• Verify sensor wiring to controller is not damaged and has continuity.• Verify sensor or wires are not shorted together.• Verify controller is setup for correct sensor curve.• Disconnect wires from sensor terminal block, tighten terminal block screws down, and take a resistance (ohm) reading with a multimeter.• Compare the resistance reading to the Temperature Vs Resistance Curves online: http://www.workaci.com/content/thermistor-curves-0• Verify proper mounting location to confirm no external factors are affecting reading.
Sensor reads infinity/very high resistance	<ul style="list-style-type: none">• Sensor or wires are open.
Sensor reads low resistance	<ul style="list-style-type: none">• Sensor or wires are shorted together.
Erratic readings	<ul style="list-style-type: none">• Condensation on PCB board• Bad wire connections.

WARRANTY

The ACI Bullet Probe Series temperature sensors are covered by ACI's Five (5) Year Limited Warranty, which is located in the front of ACI'S SENSORS & TRANSMITTERS CATALOG or can be found on ACI's website: www.workaci.com.

W.E.E.E. DIRECTIVE

At the end of their useful life the packaging and product should be disposed of via a suitable recycling centre. Do not dispose of with household waste. Do not burn.

PRODUCT SPECIFICATIONS

SENSOR NON-SPECIFIC INFORMATION		
Number Sensing Points:	One	
Operating Humidity Range:	10 to 95% RH, non-condensing	
Plate Material:	304 Stainless Steel	
Wire Size	22 AWG (0.65 mm)	
THERMISTOR		
Operating Temperature Range:	-40 to 150°C (-40 to 302°F)	
Storage Temperature Range:	-40 to 85°C (-40 to 185°F)	
Sensor Output @ 25 °C (77 °F): (Lead Wire Colors) <small>*Does not include CL2P</small>	A/1.8K: 1.8 KΩ nominal (Red/Yellow) A/2252: 2.252 KΩ nominal (White/Red) A/3K: 3 KΩ nominal (White/Brown) A/5K: 5 KΩ nominal (Red/Gray) A/AN (Type III): 10 KΩ nominal (White/White) A/AN-BC: 5.238 KΩ nominal (White/Yellow) A/50K: 50KΩ nominal (Brown/Yellow)	A/CP (Type II): 10 KΩ nominal (White/Green) A/CSI: 10 KΩ nominal (Green/Yellow) A/10KS: 10 KΩ nominal (White/Blue) A/10K-E1: 10 KΩ nominal (Orange/Gray) A/20K: 20 KΩ nominal (Brown/Blue) A/100KS: 100 KΩ nominal (Black/Yellow) A/10K-E1 Series: +/- 0.3 °C (+/- 0.54 °F)
Accuracy @ 0-70 °C (32 - 158 °F):	A/1.8K Series: +/- 0.5 °C @ 25 °C (77 °F) and (+/-1.0 °C) (+/-1.8 °F)	All Else: +/- 0.2 °C (+/- 0.36 °F)
PLATINUM		
Operating Temperature Range:	-40 to 200 °C (-40 to 392 °F)	
Storage Temperature Range:	-40 to 85°C (-40 to 185°F)	
Sensor Output @ 0 °C (32 °F):	A/100: 100 Ω nominal	A/1K: 1 KΩ nominal
Accuracy @ 0 °C (32 °F):	+/- 0.06% Class A (Tolerance Formula: +/- °C = (0.15 °C + (0.002 * t)) where t is the absolute value of Temperature above or below 0 °C in °C @ -40 °C (-40 °F): +/- 0.23°C (+/- 0.414 °F) @ 200 °C 392 °F): +/- 0.55 °C (+/- 0.99 °F) @ 0 °C (32 °F): +/- 0.15°C (+/- 0.27 °F)	
NICKEL		
Operating Temperature Range:	-40 to 121 °C (-40 to 250 °F)	
Storage Temperature Range:	-40 to 85 °C (-40 to 185 °F)	
Sensor Output @ 21.1 °C (70 °F):	1 KΩ nominal (Red/Red)	
Accuracy:	@ -40 °C (-40 °F): +/- 1.52 °C (+/- 2.73 °F) @ 0 °C (32 °F): +/- 0.4 °C (+/- 0.72 °F) @ 21.1 °C (70 °F): +/- 0.17 °C (+/- 0.34 °F)	@ 54.4 °C (130 °F): +/- 0.56 °C (+/- 1.00 °F) @ 121 °C (250 °F): +/- 1.25 °C (+/- 2.25 °F)
BALCO		
Operating Temperature Range:	-40 to 121 °C (-40 to 250 °F)	
Storage Temperature Range:	-40 to 85 °C (-40 to 185 °F)	
Sensor Output @ 21.1 °C (70 °F):	1 KΩ nominal (Orange/Yellow)	
Accuracy @ 21.1 °C (70 °F):	+/- 1%	

