

1 YEAR
WARRANTY



RoHS

Ω OMEGA™ **User's Guide**



***Shop online at
omega.com***

e-mail: info@omega.com

**For latest product
manuals:**

**[www.omega.com/en-us/
pdf-manuals](http://www.omega.com/en-us/pdf-manuals)**

DR-14E
**Isolated signal converter
with universal power supply
for Electrical signals, DIN Rail Mount**



omega.com info@omega.com

Omega Engineering, Inc:

800 Connecticut Ave. Suite 5N01, Norwalk, CT 06854, USA

Toll-Free: 1-800-826-6342 (USA & Canada only)

Customer Service: 1-800-622-2378 (USA & Canada only)

Engineering Service: 1-800-872-9436 (USA & Canada only)

Tel: (203) 359-1660

Fax: (203) 359-7700

e-mail: info@omega.com

**Omega Engineering,
Limited:**

1 Omega Drive, Northbank,
Irlam Manchester M44 5BD
United Kingdom

**Omega Engineering,
GmbH:**

Daimlerstrasse 26 75392
Deckenpfronn Germany

SIGNAL CONVERTER DR-I4E

Signal converter for electrical signals, isolated, for industrial applications

Isolated signal converter for electrical signals. Accepts a wide range of AC and DC voltages, with ranges from 50mVac/dc up to 600 Vac/dc, and a wide range of AC and DC current signals, from 5mAac/dc up to 5Aac/dc. The instrument can be configured to measure frequency from any of the AC voltage and AC current signals accepted. Unipolar and bipolar signals accepted for DC voltage and DC current signals.

Configurable output in 4/20mA (active or passive) or 0/10Vdc. Universal power supply from 18 to 265 Vac/dc. 3 way isolation between input, output and power circuits. Circuit isolation prevents ground loops and transient propagation, protecting remote equipment and signal integrity.

Predefined configuration codes available for fast and easy configuration. Advanced configuration menu available to customize input and output signal ranges to specific values required. Configuration through front push-button keypad. Front information displays available for configuration and system information (input signal value, output signal value, configured label, signal percentage and process value).

Built-in 'force' functions to manually generate low and high output signals, to validate remote instrumentation during installation. 'SOS' mode to help on critical maintenance and repairs. Configurable power frequency rejection filter. 'Password' function to block non-authorized access to 'configuration menu'.

Designed for industrial use, with potential integration into a wide range of applications, reduced cost, excellent quality and available customization.

USER'S MANUAL

INDEX

1. How to order	2
2. Material included	2
3. Additional information	2
4. Installation and start-up	3
5. Typical applications	3
6. SOS mode	3
7. Messages	3
8. Predefined configuration codes	4
9. Connections and dimensions (mm (inch))	5
10. How to operate the instrument	6
10.1 Configuration system	6
10.2 'Normal mode' of operation	6
10.3 How to operate the 'Configuration menu'	6
10.4 How to operate the 'Force' menu	7
10.5 How to activate the 'Messages' function	7
10.6 Fast and advanced configurations	7
11. Input signals	8
11.1 AC Voltages	8
11.2 DC Voltages	8
11.3 AC Currents	9
11.4 DC Currents	9
11.5 Frequency AC	10
12. Technical specifications	11
13. Configuration menu	12
13.1 Function codes	12
13.2 Input range	12
13.3 Output range	13
13.4 Advanced scaling	14
13.5 Display information	15
13.6 Key 'UP' (force menu)	15
13.7 Key 'LE' ('messages' function)	16
13.8 'Tools' menu	17
14. Full configuration menu	18
15. Factory default parameters	20
16. Error codes	20
17. Precautions on installation	21
18. Warranty	21
19. CE declaration of conformity	21



When the marks 'Attention' or 'Risk of electrical shock' appear, read the documentation for information about the nature of the risk.



1. How to order

Reference	Description
DR-I4E	Signal converter

2. Material included

The instrument is provided with the following elements:

- 1 x instrument **DR-I4E**
- 4 x plug-in screw terminals
- 1 x quick installation guide

3. Additional information

To view the DR-I4E spec sheet and manuals visit us at <http://www.omega.com/...>

4. Installation and start-up

If this is the first time you are configuring the instrument, below are the steps to follow during a first installation. Read all the manual sections in order to have a full and clear view of the characteristics of the instrument. Do not forget to read the installation precautions at section 17.



1. Install the instrument at the DIN rail
2. Read how to operate the instrument (see section 10)
3. Connect the input, the output and the power terminals (see section 9).
4. Configure the input and output signals
 - choose a predefined configuration code (see section 8)
 - introduce the code at the instrument (see section 13.1)
5. If needed, customize the input and output signal ranges (see section 13.4)
6. If needed, configure the display reading (see section 13.5), the key 'UP' (▲) 'force' menu (see section 13.6), and the key 'LE' (◀) 'messages' function (see section 13.7),
7. If needed, block access to the 'configuration menu' (see section 13.8)

5. Typical applications

To measure electrical signals in AC and DC and provide a standard process signal in 4/20mA or 0/10Vdc. Accepts signals from current shunts, signals from DC batteries of 12Vdc, 24Vdc, 48Vdc, ..., signals from tachometric dynamos of ±60Vdc, power lines of 230Vac, 115Vac, 48Vac, 24Vdc, AC leak currents of down to 5mAac and below, 50 and 60Hz frequency signals from AC power lines, signals from X/5 and X/1 current transformers.

6. SOS mode

The instrument includes a configurable 'SOS mode' function that provides a way to manually configure a fixed output signal. This output signal remains fixed, independent of the input signal value or sensor state.

This function allows to perform urgent maintenance or repair tasks at the input section of the system, for example replacing sensors, shunts, or deactivating power lines, while the instrument still provides a controlled signal that allows for the process to continue its activity, under human surveillance. When the maintenance or repair task has been performed, the instrument can be taken back to the standard working mode, where the output signal is proportional to the input.

When manually activated, the 'SOS mode' generates the output signal configured, and the front display remains flashing with the message 'SoS'. All other systems are disabled, which means that :

- no error messages will be shown on display
- no key 'UP' (▲) 'fast access' menu is accessible
- no key 'LE' (◀) 'messages' function is accessible
- no 'Eco' mode activates

Only key 'SQ' (■) is accessible, to access the 'configuration menu' (eventually this access can be password locked) in order to deactivate the 'SOS mode'. Deactivation of 'SOS mode' must be performed manually by configuring the function to 'oFF'.

To configure the 'SOS mode' function, see section 13.8.

7. Messages

The instrument includes a configurable 'messages' function that provides advanced system information on the display, available to the operator with a single click at the front key 'LE' (◀).

This information is helpful during start-up, installation, system verification, routine maintenance and troubleshooting, as messages and values provide information on the actual input and output signal value, actual percentage of the input signal compared to the full scale and scaled process values.

This information is available at any time, and is displayed sequentially when requested. Access to this information reduces maintenance time, improves time invested in failure location, and helps for an easy resolution of the problem.

Additionally, each instrument can be assigned a custom label code of up to 8 characters (see Table 1), that can be displayed at the front display or at the messages sequence, making system identification of each instrument an easy task.

To configure the 'messages' function, see section 13.7.

Table 1 | Available label codes ('Label' parameter)

Letters		Numbers	Special
A	n	0	-
b	o	1	_
c	P	2	.
d	q	3	(blank)
E	r	4	
F	S	5	
G	t	6	
h	u	7	
I	V	8	
J	W	9	
K	X		
L	Y		
M	Z		

Labeling examples ('Label' parameter): for an application with multiple engine control, where voltage and frequency are being measured for three engines, and converted to 4/20mA for retransmission to PLC or SCADA. Six DR-I4E converters are being used, to measure 0/300Vac and 45/55Hz. Each DR-I4E can be configured the following label for easy identification :

- Label for engine 1 frequency measurement : Eng1.hZ
- Label for engine 2 frequency measurement : Eng2.hZ
- Label for engine 3 frequency measurement : Eng3.hZ
- Label for engine 1 voltage measurement : Eng1.Vac
- Label for engine 2 voltage measurement : Eng2.Vac
- Label for engine 3 voltage measurement : Eng3.Vac

8. Predefined configuration codes

Select the desired code for your application, and check the following sections for more information:

- for information on how to activate a code, see section 13.1
- to customize the input and output signals, see section 13.4
- to configure input for bipolar DC signals, see section 13.4

Table 2 | Predefined configuration codes - Input / Output

Input Signal Range	Output 4/20mA Code	Output 0/10Vdc Code	See section ...
0/600 Vac	010	110	11.1
0/450 Vac	011	111	
0/300 Vac	012	112	
0/150 Vac	013	113	
0/100 Vac	014	114	
0/60 Vac	015	115	
0/30 Vac	016	116	
0/15 Vac	017	117	
0/10 Vac	018	118	
0/2 Vac	019	119	
0/1 Vac	020	120	
0/500 mVac	021	121	
0/300 mVac	022	122	
0/200 mVac	023	123	
0/150 mVac	024	124	
0/100 mVac	025	125	
0/75 mVac	026	126	
0/60 mVac	027	127	
0/50 mVac	028	128	
Reserved	029 to 031	129 to 131	
0/600 Vdc	032	132	11.2
0/450 Vdc	033	133	
0/300 Vdc	034	134	
0/150 Vdc	035	135	
0/100 Vdc	036	136	
0/60 Vdc	037	137	
0/30 Vdc	038	138	
0/15 Vdc	039	139	
0/10 Vdc	040	140	
0/2 Vdc	041	141	
0/1 Vdc	042	142	
0/500 mVdc	043	143	
0/300 mVdc	044	144	
0/200 mVdc	045	145	
0/150 mVdc	046	146	
0/100 mVdc	047	147	
0/75 mVdc	048	148	
0/60 mVdc	049	149	
0/50 mVdc	050	150	
Reserved	051 to 054	151 to 154	

Table 2 | Predefined configuration codes - Input / Output

Input Signal Range	Output 4/20 mA Code	Output 0/10 Vdc Code	See section ...
0/5 Aac	055	155	11.3
0/4 Aac	056	156	
0/3 Aac	057	157	
0/2 Aac	058	158	
0/1 Aac	059	159	
0/500 mAac	060	160	
0/300 mAac	061	161	
0/75 mAac	062	162	
0/50 mAac	063	163	
0/20 mAac	064	164	
0/10 mAac	065	165	
0/5 mAac	066	166	
Reserved	067 to 071	167 to 171	
0/5 Adc	072	172	11.4
0/4 Adc	073	173	
0/3 Adc	074	174	
0/2 Adc	075	175	
0/1 Adc	076	176	
0/500 mAdc	077	177	
0/300 mAdc	078	178	
0/75 mAdc	079	179	
0/50 mAdc	080	180	
0/20 mAdc	081	181	
0/10 mAdc	082	182	
0/5 mAdc	083	183	
Reserved	084 to 088	184 to 188	
0/100 Hz (Vac)	089	189	11.5
45/55 Hz (Vac)	090	190	
55/65 Hz (Vac)	091	191	
0/100 Hz (Aac)	092	192	
45/55 Hz (Aac)	093	193	
55/65 Hz (Aac)	094	194	
Reserved	091 to 099	191 to 199	
(End of list)	'---	(see notes below)	
(Custom selection)	'uSER'	(see notes below)	

Notes

• Code **'uSER'** indicates that a user custom configuration is active, and it does not match any of the listed codes. This code is non-selectable, for information only.

Example: select code **'011'** for 0/450 Vac=4/20 mA, the instrument reads code **'011'**. Later, configure the input to 0/350 Vac=4/20 mA, this does not match a listed code, and the instrument reads **'uSER'**. Or change the output to 0/450 Vac=1/5 Vdc, this does not match a listed code, and the instrument reads **'uSER'**.

• Code **'---** identifies the end of the list, it follows code **'199'** and the list continues with code **'010'**. Select **'---** to exit the list without applying changes.

9. Connections and dimensions (mm (inch))

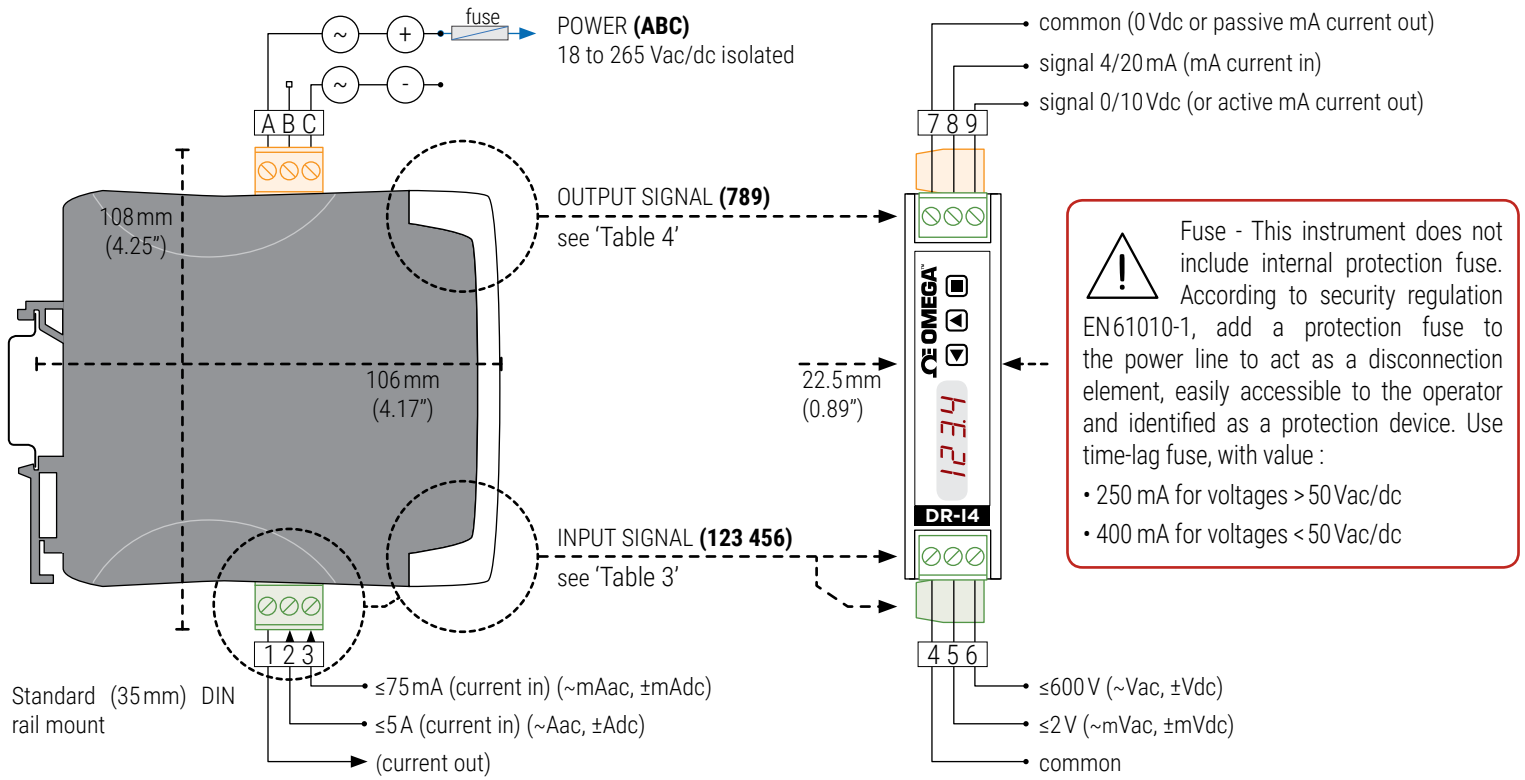

Table 3 | INPUT signal connections

INPUT signal	Input terminals						Section ...
	1	2	3	4	5	6	
≤600Vac				~Vac		~Vac	11.1
≤600Vdc				comm.		±Vdc	11.2
≤2Vac				~mVac	~mVac		11.1
≤2Vdc				comm.	±mVdc		11.2
≤5Aac	~Aac	~Aac					11.3
≤5Adc	-Adc (out)	+Adc (in)					11.4
≤75mAac	~mAac		~mAac				11.3
≤75mAac	-mAac (out)		+mAac (in)				11.4
Frequency	Connect to the Aac, mAac, Vac or mVac terminals, according to the signal measured (AC voltage or AC current)						11.5

Table 4 | OUTPUT signal connections

OUTPUT signal	Output terminals			Connections
	7	8	9	
4/20mA active output		mA- (in)	mA+ (out)	
4/20mA passive output* (*external loop power needed)	mA+ (out)	mA- (in)		
0/10Vdc	common		+Vdc	

10. How to operate the instrument

10.1 Configuration system

The instrument is fully configurable from the 3 push button keypad and the 4 red digit led display at the front of the instrument (see Table 5).

Table 5 | CONFIGURATION SYSTEM

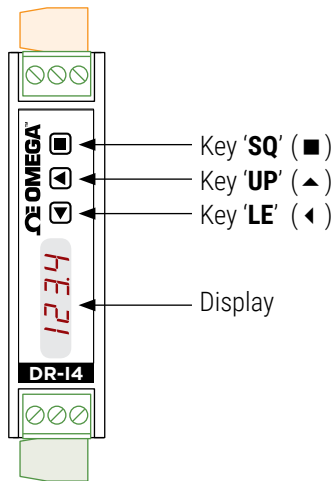

10.2 'Normal mode' of operation

AT POWER-UP

When the power supply is connected, the instrument applies the following sequence:

- the 'display' shows the firmware code 'A6.xx'.
- the 'display' shows the configured 'units' and 'input range' (for example: 'Vac' and '600V').
- the instrument is now in 'normal mode' of operation and the 'display' shows the 'information' configured at section 13.5.

FROM 'NORMAL MODE' OF OPERATION

From 'normal mode' of operation, the operator can access the following functions:

- key 'SQ' (■) gives access to the 'configuration menu' (see section 10.3).
- key 'UP' (▲) gives access to the 'force' menu (see section 10.4).
- key 'LE' (◀) activates the 'messages' function (see section 10.5).

'ECO' FUNCTION ('DISPLAY' POWERED OFF)

The 'Eco' function powers off the display under the following conditions:

- the instrument is in 'normal mode' of operation.
- there is no interaction from the operator for 60 seconds.

The decimal point remains active (flashing), indicating that the instrument is working correctly. This is a configurable function, enabled by default. To configure the 'Eco' function, see section 13.8.

Table 6 | 'ECO' DECIMAL POINT

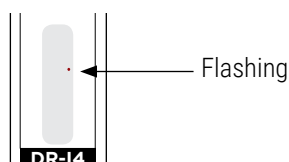

10.3 How to operate the 'Configuration menu'

HOW TO ENTER THE 'CONFIGURATION MENU'

With the instrument in 'normal mode' of operation (see section 10.2), press the 'SQ' (■) key and maintain for 1 second. The horizontal leds light from bottom to top. When the upper led lights, the instrument enters into the 'configuration menu'.

When entering the 'configuration menu', the first menu entry 'Function code' (codE) is displayed. See section 14 for a full view of the 'configuration menu'.



If the 'SQ' (■) key is released before entering into the 'configuration menu', the horizontal leds light downwards from top to bottom, and the instrument returns to 'normal mode' of operation.

HOW TO OPERATE INSIDE THE 'CONFIGURATION MENU'

Inside the 'configuration menu', use the front keypad to move through menu entries, parameters, and select configuration values:

- Key 'SQ' (■) functions as the 'ENTER' key. It selects the menu entry currently displayed. At numerical value entries, it validates the number displayed.
- Key 'UP' (▲) moves vertically through the different menu entries. At numerical value entries, it modifies the selected digit by increasing its value to 0, 1, 2, 3, 4, 5, 6, 7, 8, 9.
- Key 'LE' (◀) functions as the 'ESCAPE' key. It leaves the selected menu entry, and eventually, will leave the 'configuration menu'. When leaving the 'configuration menu', the changed parameters are activated. At numerical value entries, the 'LE' (◀) key allows to select the active digit. To modify a numeric value press the 'UP' (▲) key to increase the value '+1'. Press the 'SQ' (■) key to validate the value.

WHEN EXITING THE 'CONFIGURATION MENU'

When exiting the 'configuration menu' without changes (either by 'rollback' activation or because there are no changes in the configuration), the horizontal leds light down from top to bottom, and the instrument returns to 'normal mode' of operation.

When exiting the 'configuration menu' with changes, the display leds light a round shape while the new configuration is stored. When the round shape is finished, a start-up is applied (see section 10.2). After start-up, the new configuration is active and the instrument is in 'normal mode' of operation.

'ROLLBACK' FUNCTION

If there is no interaction from the operator for 60 seconds, the instrument exits the 'configuration menu' discarding changes, and returns to 'normal mode' of operation.



When the operator is inside the 'configuration menu', the output signal will remain overranged at maximum signal. Additional configurations are available at the 'On error' parameter (see section 13.8).



When the operator exits the 'configuration menu', the output signal is temporarily set to minimum value for a time <5seconds, while the instrument restarts.

10. How to operate the instrument (cont.)

10.4 How to operate the 'Force' menu

HOW TO ENTER THE 'FORCE' MENU

With the instrument in 'normal mode' of operation (see section 10.2), press and hold the 'UP' (▲) key for 1 second. The horizontal leds light from bottom to top. When the upper led lights, the instrument enters into the 'force' menu.

If the 'UP' (▲) key is released before entering into the 'force' menu, the horizontal leds light downwards from top to bottom, and the instrument returns to 'normal mode' of operation.

HOW TO OPERATE INSIDE THE 'FORCE' MENU

The available functions inside the 'force' menu can be configured (see section 13.6). By default, 'Force High', 'Force Low' and 'Force Set' are available. Inside the 'force' menu:

- press the 'UP' (▲) key to move to the next function.
- press the 'SQ' (■) key to activate the selected function.

When the function is active, the display will remain flashing. Press the 'SQ' (■) key to deactivate the function (display stops flashing), or wait for the rollback to activate.

Table 7 | Example of 'Force' menu with all functions set to 'on'

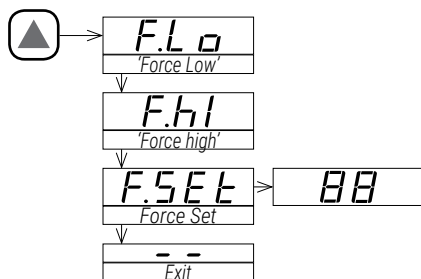

See section 13.6 for a list and a description of available functions.

DESCRIPTION OF 'FORCE' FUNCTIONS

The 'force' functions allow to manually force the output signal to the low and high levels of the output signal selected. These functions allow to easily validate the correct function of remote elements connected to the instrument output, such as PLC, HMI's, SCADAs, etc.

The 'force low' function sets the output signal to the minimum value of the selected range (4mA or 0Vdc or the value configured at the 'output_low' parameter).

The 'force high' function sets the output signal to the maximum value of the selected range (20mA or 10Vdc or the value configured at the 'output_high' parameter).

The 'force set' function sets the output signal to a value between 0 and 100% of the maximum selected range (4 to 20mA or 0 to 10Vdc or the range configured at the 'output_low' and 'output_high' parameters). When entering the 'force set' function, the display reads '50' (the output is forced to 50% of the configured range). Use keys 'UP' (▲) and 'LE' (◀) to move up to 100% or down to 0% of the configured range.

HOW TO EXIT 'FORCE' MENU

To exit the 'force' menu, press the 'LE' (◀) key, or press the key 'UP' (▲) key until the parameter '---' appears, and select by pressing the 'SQ' (■) key, or wait without pressing any key until the automatic 'rollback' activates.

When exiting the 'force' menu, the horizontal leds light down from top to bottom, and the instrument returns to 'normal mode' of operation.

'ROLLBACK' FUNCTION

If there is no interaction from the operator for 60 seconds, the instrument exits the 'force' menu and returns to 'normal mode' of operation.

10.5 How to activate the 'Messages' function

HOW TO ACTIVATE 'MESSAGES' FUNCTION

With the instrument in 'normal mode' of operation (see section 10.2), press the 'LE' (◀) key to activate the 'messages' function. The 'messages' function displays information about the instrument. The information available is configurable (see section 13.7).

The 'messages' function ends when all the information has been displayed or front keys 'UP' (▲) or 'SQ' (■) are pressed. The 'display' returns to 'normal mode' of operation.

10.6 Fast and advanced configurations

FAST CONFIGURATION

The fastest way to configure the instrument is to activate one of the predefined configuration codes (see section 8).

Access the 'configuration menu' and enter the 'Function code' (codE) menu entry. The code displayed is the current active input-output range. Select the new code and validate. Selecting a code automatically exits the 'configuration menu' and activates the new configuration.



*There are different codes for 4/20mA and 0/10Vdc output signals.

To customize the input and output signals, see the 'Advanced scaling' section of the 'configuration menu' (see section 13.4).

ADVANCED CONFIGURATION

Additional configuration parameters are available at the 'configuration menu'. The operator can customize the input and output signal ranges, the message seen on display, the functions available at the 'force' menu, the messages associated to the 'LE' (◀) key, activate filters, password function, etc.

See section 13 for a detailed explanation on the 'configuration menu'.



All Vdc and Adc input signal ranges can be customized to read bipolar ranges. Check the 'Advanced scaling' section of the 'configuration menu' (see section 13.4).

11. Input signals

11.1 AC Voltages



INPUT RANGES FOR AC VOLTAGES

The instrument can be configured to measure AC voltages, with pre-configured ranges from 50 mVac up to 600 Vac. Measure is performed in True RMS value. Accepts phase-to-neutral and phase-to-phase connections. See connections at 'Table 8'.

PREDEFINED CONFIGURATION CODES

See 'Table 9' for a list of predefined input-output configuration codes. To activate a code see section 13.1.

CUSTOMIZED SIGNAL RANGES

To customize the input and/or output signal ranges, access the 'Advanced scaling' menu (see section 13.4).

MAXIMUM OVERSIGNAL

'Maximum oversignal' is the maximum signal accepted by the instrument. Higher signal values may damage the instrument. Lower signal values are non destructive but may be out of accuracy specifications.

Table 8 | Connection examples for AC voltage signals

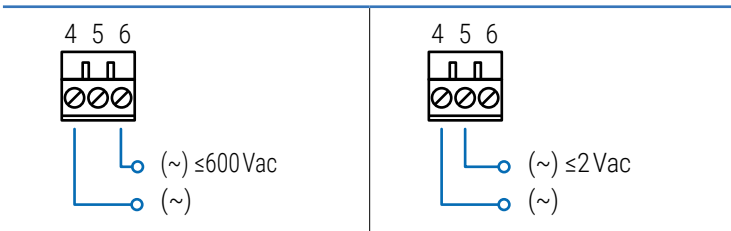

Table 9 | Input signal ranges for AC voltage signals

Input range	Code for 4/20mA output	Code for 0/10 Vdc output	Accuracy (%FS)	Max. oversignal	Zin
0/600 Vac	010	110	<0.30%	800 Vac	13M0hm
0/450 Vac	011	111	<0.30%		
0/300 Vac	012	112	<0.30%		
0/150 Vac	013	113	<0.30%		
0/100 Vac	014	114	<0.30%		
0/60 Vac	015	115	<0.30%		
0/30 Vac	016	116	<0.30%		
0/15 Vac	017	117	<0.30%		
0/10 Vac	018	118	<0.30%		
0/2 Vac	019	119	<0.30%		
0/1 Vac	020	120	<0.30%	50 Vac	81 K0hm
0/500 mVac	021	121	<0.30%		
0/300 mVac	022	122	<0.30%		
0/200 mVac	023	123	<0.30%		
0/150 mVac	024	124	<0.30%		
0/100 mVac	025	125	<0.30%		
0/75 mVac	026	126	<0.30%		
0/60 mVac	027	127	<0.30%		
0/50 mVac	028	128	<0.30%		

11.2 DC Voltages



INPUT RANGES FOR DC VOLTAGES

The instrument can be configured to measure DC voltages with pre-configured ranges from 50 mVdc up to 600 Vdc. See connections at 'Table 10'. Bipolar ranges from ±50 mVdc up to ±600 Vdc can also be configured (see section 13.4).

PREDEFINED CONFIGURATION CODES

See 'Table 11' for a list of predefined input-output configuration codes. To activate a code see section 13.1.

CUSTOMIZED SIGNAL RANGES

To customize the input and/or output signal ranges, access the 'Advanced scaling' menu (see section 13.4).

MAXIMUM OVERSIGNAL

'Maximum oversignal' is the maximum signal accepted by the instrument. Higher signal values may damage the instrument. Lower signal values are non destructive but may be out of accuracy specifications.

Table 10 | Connection examples for DC voltage signals

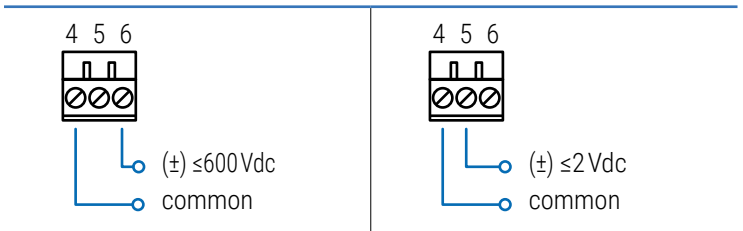

Table 11 | Input signal ranges for DC voltage signals

Input range	Code for 4/20mA output	Code for 0/10 Vdc output	Accuracy (%FS)	Max. oversignal	Zin
0/600 Vdc	032	132	<0.20%	800 Vdc	13M0hm
0/450 Vdc	033	133	<0.20%		
0/300 Vdc	034	134	<0.20%		
0/150 Vdc	035	135	<0.20%		
0/100 Vdc	036	136	<0.20%		
0/60 Vdc	037	137	<0.20%		
0/30 Vdc	038	138	<0.20%		
0/15 Vdc	039	139	<0.20%		
0/10 Vdc	040	140	<0.20%		
0/2 Vdc	041	141	<0.20%		
0/1 Vdc	042	142	<0.20%	50 Vdc	81 K0hm
0/500 mVdc	043	143	<0.20%		
0/300 mVdc	044	144	<0.20%		
0/200 mVdc	045	145	<0.20%		
0/150 mVdc	046	146	<0.20%		
0/100 mVdc	047	147	<0.30%		
0/75 mVdc	048	148	<0.30%		
0/60 mVdc	049	149	<0.30%		
0/50 mVdc	050	150	<0.30%		

11. Input signals (cont.)

11.3 AC Currents



INPUT RANGES FOR AC CURRENTS

The instrument can be configured to measure AC currents with with pre-configured ranges from 5mAac up to 5Aac. Measure is performed in True RMS value. Accepts phase-to-neutral and phase-to-phase connections. See connections at 'Table 12'.

PREDEFINED CONFIGURATION CODES

See 'Table 13' for a list of predefined input-output configuration codes. To activate a code see section 13.1.

CUSTOMIZED SIGNAL RANGES

To customize the input and/or output signal ranges, access the 'Advanced scaling' menu (see section 13.4).

MAXIMUM OVERSIGNAL

'Maximum oversignal' is the maximum signal accepted by the instrument. Higher signal values may damage the instrument. Lower signal values are non destructive but may be out of accuracy specifications.

Table 12 | Connection examples for AC current signals

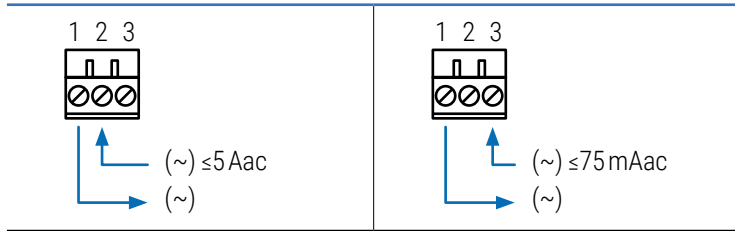

Table 13 | Input signal ranges for AC current signals

Input range	Code for 4/20mA output	Code for 0/10Vdc output	Accuracy (%FS)	Max. oversignal	Zin
0/5Aac	055	155	<0.30%	7Aac (max.7sec.)	20mOhm
0/4Aac	056	156	<0.30%		
0/3Aac	057	157	<0.30%		
0/2Aac	058	158	<0.30%		
0/1Aac	059	159	<0.30%		
0/500mAac	060	160	<0.30%		
0/300mAac	061	161	<0.30%	150mAac	3.330hm
0/75mAac	062	162	<0.30%		
0/50mAac	063	163	<0.30%		
0/20mAac	064	164	<0.30%		
0/10mAac	065	165	<0.30%		
0/5mAac	066	166	<0.30%		

11.4 DC Currents



INPUT RANGES FOR DC CURRENTS

The instrument can be configured to measure DC currents with pre-configured ranges from 5mAdc up to 5Adc. See connections at 'Table 14'. Bipolar ranges from $\pm 5\text{mAdc}$ up to $\pm 5\text{Adc}$ can also be configured (see section 13.4).

PREDEFINED CONFIGURATION CODES

See 'Table 15' for a list of predefined input-output configuration codes. To activate a code see section 13.1.

CUSTOMIZED SIGNAL RANGES

To customize the input and/or output signal ranges, access the 'Advanced scaling' menu (see section 13.4).

MAXIMUM OVERSIGNAL

'Maximum oversignal' is the maximum signal accepted by the instrument. Higher signal values may damage the instrument. Lower signal values are non destructive but may be out of accuracy specifications.

Table 14 | Connection examples for DC current signals

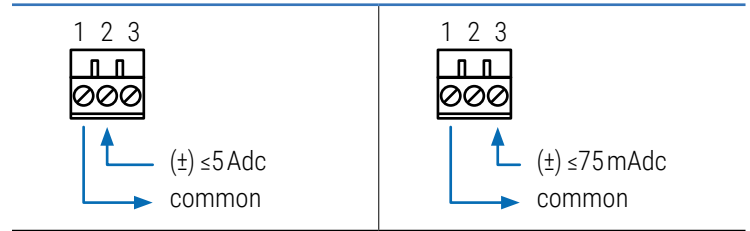

Table 15 | Input signal ranges for DC current signals

Input range	Code for 4/20mA output	Code for 0/10Vdc output	Accuracy (%FS)	Max. oversignal	Zin
0/5Adc	072	172	<0.20%	7Adc (max.7sec.)	20mOhm
0/4Adc	073	173	<0.20%		
0/3Adc	074	174	<0.20%		
0/2Adc	075	175	<0.20%		
0/1Adc	076	176	<0.20%		
0/500mAdc	077	177	<0.20%		
0/300mAdc	078	178	<0.20%	150mAdc	3.330hm
0/75mAdc	079	179	<0.20%		
0/50mAdc	080	180	<0.20%		
0/20mAdc	081	181	<0.20%		
0/10mAdc	082	182	<0.20%		
0/5mAdc	083	183	<0.20%		

11. Input signals (cont.)

11.5 Frequency AC



INPUT RANGES FOR FREQUENCY AC

The instrument can be configured to measure frequency from AC voltages and AC currents, for typical power network frequency of 50 and 60 Hz, and up to 100 Hz.

PREDEFINED CONFIGURATION CODES

See 'Table 18' for a list of predefined configuration codes for input-output signal ranges. To activate a code see section 13.1.

CUSTOMIZED SIGNAL RANGES

To customize the input and/or output signal ranges, access the 'Advanced scaling' menu (see section 13.4).

CONNECTIONS

The frequency signal is measured from Vac or Aac signals. Use the Vac or Aac signal connections according to the input signal connected. See 'Table 16' and 'Table 17' for connections.

Table 16 | Connection examples for AC voltage signals

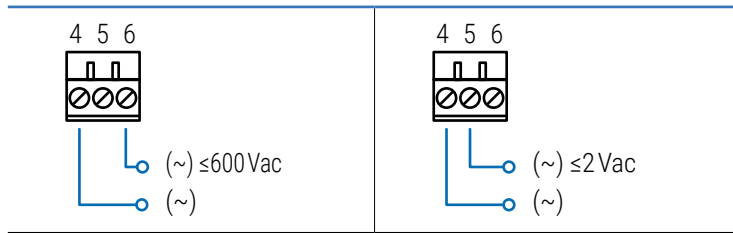

Table 17 | Connection examples for AC current signals

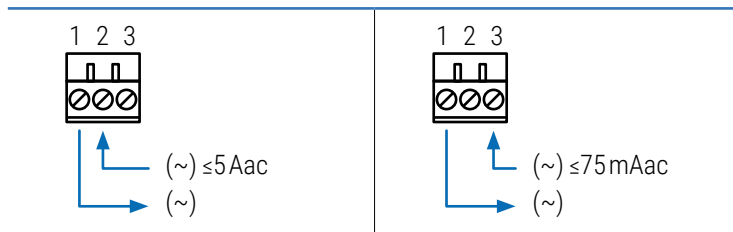

Table 18 | Input signal ranges for AC frequency signals

Input range	Code for 4/20 mA output	Code for 0/10 Vdc output	Accuracy (%FS)
0/100 Hz (Vac)	089	189	<0.20%
45/55 Hz (Vac)	090	190	<0.20%
55/65 Hz (Vac)	091	191	<0.20%
0/100 Hz (Aac)	092	192	<0.20%
45/55 Hz (Aac)	093	193	<0.20%
55/65 Hz (Aac)	094	194	<0.20%

12. Technical specifications

INPUT SIGNAL RANGES VAC

ranges	from 50 mVac up to 600 Vac (see section 11.1)
type of measure	True RMS
connections accepted	phase-to-phase phase-to-neutral
category of measure	CAT-II up to 300 Vac

INPUT SIGNAL RANGES VDC

ranges unipolar	from 0/50 mVdc up to 0/600 Vdc (see section 11.2)
ranges bipolar	from ± 50 mVdc up to ± 600 Vdc (see section 11.2)

INPUT SIGNAL RANGES AAC

ranges	from 5 mAac up to 5 Aac (see section 11.3)
type of measure	True RMS
connections accepted	phase-to-neutral phase-to-phase

INPUT SIGNAL RANGES ADC

ranges unipolar	from 0/5 mAdc up to 0/5 Adc (see section 11.4)
ranges bipolar	from ± 5 mAdc up to ± 5 Adc (see section 11.4)

FREQUENCY AC

ranges	up to 100 Hz (see section 11.5)
measured from	measured from existing Vac and Aac signal ranges

ACCURACY AT 25 °C

	see for each type of signal at section 11* <i>*accuracy values are indicated for 4/20 mA output. For 0/10 Vdc output, add +0.05% to indicated accuracy values.</i>
--	---

THERMAL DRIFT

	150 ppm/°
--	-----------

STEP RESPONSE

AC signals	<350 mSec. typ. (0 to 99%)
DC signals*	<90 mSec. typ. (0 to 99%) 'no filter'
(*see 'Power filter' at section 13.8)	<175 mSec. typ. (0 to 99%) '50Hz filter' or '60Hz filter'
	<350 mSec. typ. (0 to 99%) '50 and 60Hz filter'

OUTPUT SIGNAL RANGES

active current output	4/20 mA active max. <22 mA, min. 0 mA maximum load <400 Ohm
passive current output	4/20 mA passive max. 30 Vdc on terminals
voltage output	0/10 Vdc, max. <11 Vdc, min. -0.05 Vdc (typ.) minimum load >10 KOhm

CONFIGURATION SYSTEM

key pad + display	accessible at the front of the instrument
configuration	'configuration menu' and predefined 'codes'

scalable units	scalable input ranges scalable output ranges scalable process display
----------------	---

POWER SUPPLY

voltage range	18 to 265 Vac/dc isolated (20 to 240 Vac/dc $\pm 10\%$)
AC frequency	45 to 65 Hz
consumption	<1.5 W
power wires	1 mm ² to 2.5 mm ² (AWG17 to AWG14)
overvoltage category	2

ISOLATION

input - output	3000 Veff (60 seconds)
power - input	3000 Veff (60 seconds)
power - output	3000 Veff (60 seconds)

ENVIRONMENTAL

IP protection	IP30
impact protection	IK06
operation temperature	from 0 to +50 °C
storage temperature	from -20 to +70 °C
'warm-up' time	15 minutes
humidity	0 to 95% non condensing
altitude	up to 2000 meters

MECHANICAL

size	106x108x22.5 mm
mounting	standard DIN rail (35x7.5 mm)
connections	plug-in screw terminal (pitch 5.08 mm)
housing material	polyamide V0
weight	<150 grams
packaging	120x115x30 mm, cardboard

13. Configuration menu

13.1 Function codes

The fastest way to configure the instrument, is to select a predefined configuration code (see Table 2). At the '**Configuration code**' (**codE**) parameter use keys '**UP**' (\blacktriangle) and '**LE**' (\blacktriangleleft) to move up and down through the list of codes. Locate the desired code, and press '**SQ**' (\blacksquare). The instrument shows the '**codE**' parameter. Press '**LE**' (\blacktriangleleft) to exit the '*configuration menu*'. The instrument stores the new configuration, applies a '*power-up*' routine and returns to the '*normal mode*' of operation (see section 10.2).

Selecting a '*reserved*' code or '*---*' returns to the previous menu without changes.

When entering the '**Function code**' (**codE**) parameter, the active '*configuration code*' is displayed. If the actual configuration does not match any of the configuration codes, code '**uSEr**' is displayed.

There are different codes for 4/20mA output (codes from 010 to 099) and 0/10Vdc output (codes from 110 to 199) (see section 8).

Bipolar voltage and bipolar current inputs can be configured at the '*Advanced scaling*' section of the '*configuration menu*' (see section 13.4).

13.2 Input range

At the '**Input range**' (**InP**) menu entry select the input signal range to activate.



If you have already selected a configuration code (see section 13.1), the input range has been already selected and there is no need to manually configure again at the '**Input range**' (**InP**) menu entry.

Enter the '**AC voltages**' (**VAc**) parameter for a list of voltage AC input ranges, '**DC voltages**' (**Vdc**) for a list of voltage DC input ranges, '**AC currents**' (**Aac**) for a list of AC current input ranges, '**DC currents**' (**Adc**) for a list of DC current input ranges, '**Frequency Vac**' (**Frq.V**) for AC voltage frequency or '**Frequency Aac**' (**Frq.A**) for AC current frequency measurement.

- AC voltage ranges available are 600Vac, 300Vac, 150Vac, 60Vac, 30Vac, 2Vac, 1Vac, 500mVac, 300mVac and 200mVac.
- DC voltage ranges available are 600Vdc, 300Vdc, 150Vdc, 60Vdc, 30Vdc, 2Vdc, 1Vdc, 500mVdc, 300mVdc and 200mVdc.
- AC current ranges available are 5Aac, 2Aac, 500mAac, 75mAac, 50mAac, 20mAac, 10mAac and 5mAac.
- DC current ranges available are 5Adc, 2Adc, 500mAdc, 75mAdc, 50mAdc, 20mAdc, 10mAdc and 5mAdc.
- frequency from AC voltages. Single range up to 100Hz. Measured from the AC voltage signal.
- frequency from AC currents. Single range up to 100Hz. Measured from the AC current signal.

Input signal ranges are also accessible as predefined '*configuration codes*' (see Table 2). The predefined '*configuration codes*' include some additional input-output ranges that are not available at the '**Input range**' (**InP**) list of ranges.

All DC input ranges activate the unipolar range by default.

- example: select the '60 Vdc' input range activates the '0/60 Vdc=4/20 mA' or '0/60 Vdc=0/10 Vdc' configuration. To customize to a smaller range (for example 0/45Vdc) or a bipolar range (for example ± 45 Vdc) see section 13.4. To manually select the output signal see section 13.3. To customize the output range for a smaller range (for example ± 45 Vdc=6/15mA or ± 45 Vdc=1/5Vdc) see section 13.4.

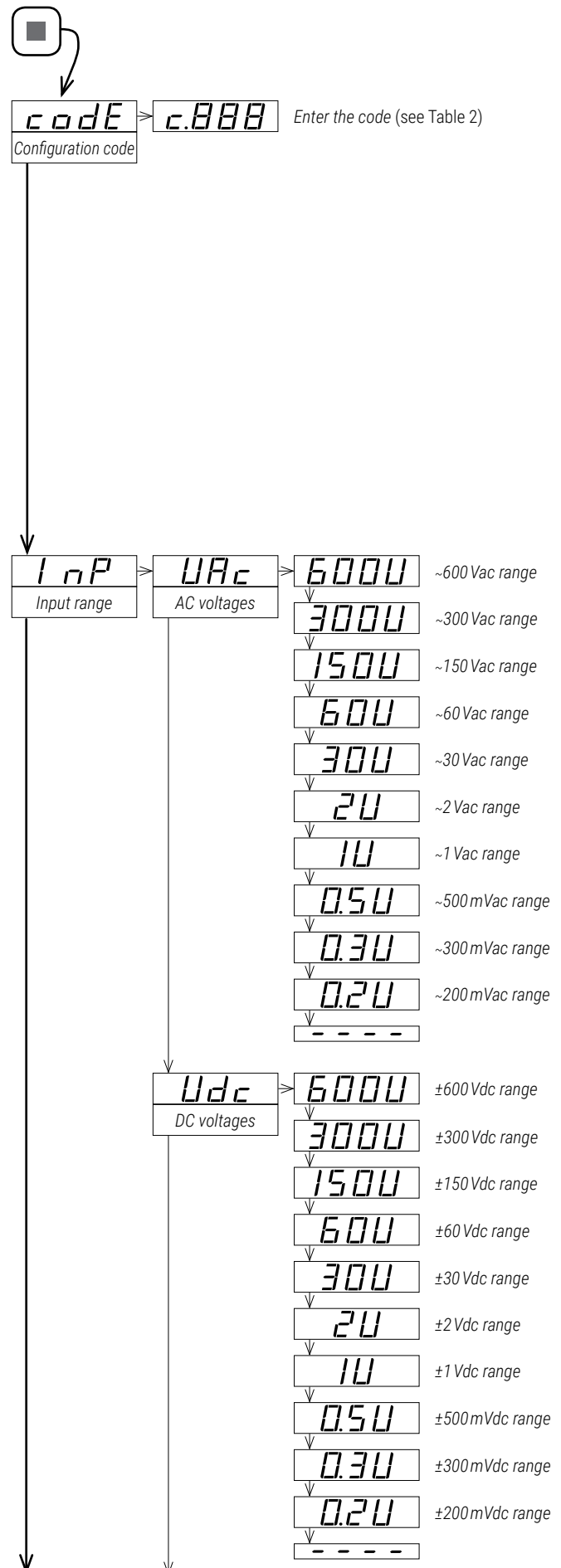

13. Configuration menu (cont.)

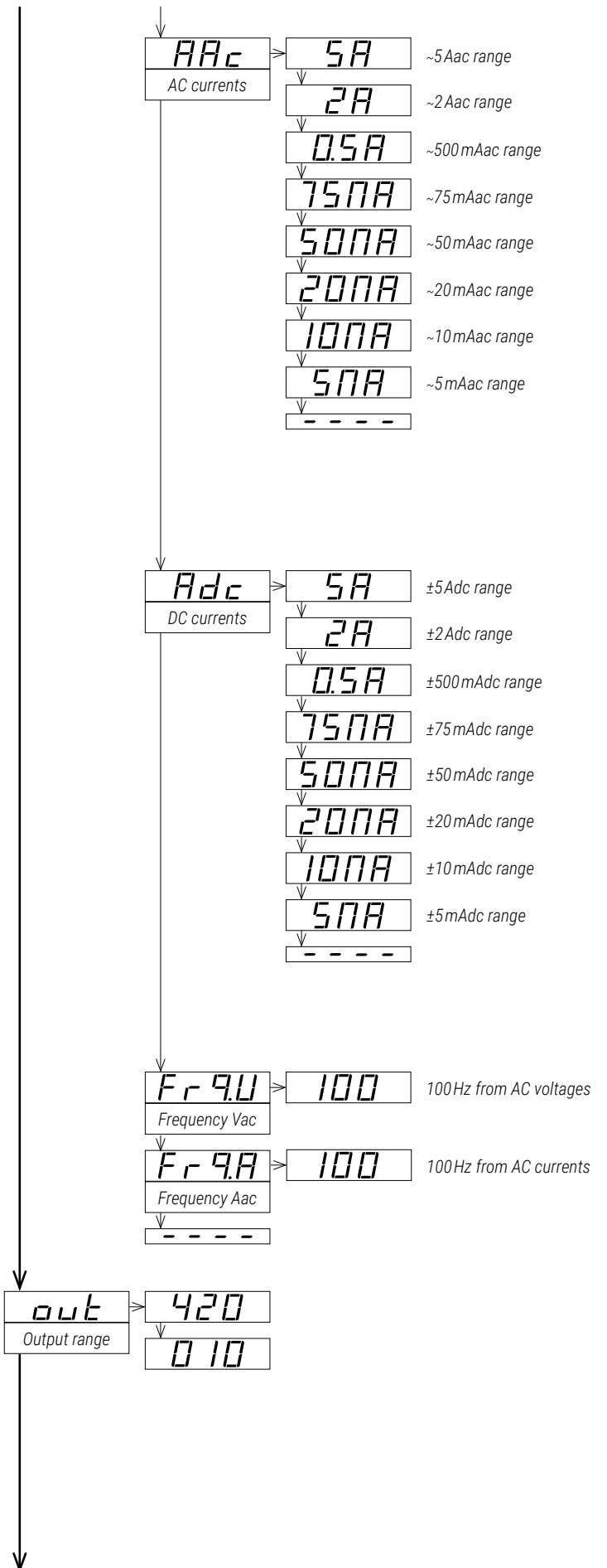

13.3 Output range

At the 'Output range' (out) menu entry, select the output signal range to 4/20mA (value '420') or to 0/10Vdc (value '010').

The output signal range selected can be later customized to operate in a reduced range of signal (see section 13.4).

13. Configuration menu (cont.)

13.4 Advanced scaling

At the **'Advanced scaling' (Ad.Sc)** menu, the input and output signal ranges can be customized. The parameters inside this menu represent the real input and output signal ranges configured at the instrument. When selecting a predefined configuration code, these parameters are configured according to the code selected. The parameters listed below, are accessible for manual configuration:

- at the **'Input low signal' (In.Lo)** parameter configure the low input signal value.
- at the **'Input high signal' (In.hi)** parameter configure the high input signal value.
- at the **'Output low signal' (ou.Lo)** parameter configure the low output signal value.
- at the **'Output high signal' (ou.hi)** parameter configure the high output signal value.

These four parameters define the relation between the input and the output signal (see Table 19), and can be modified independently, to match the specific input-output relation for your application (see Table 20).

Table 19 | EXAMPLE FOR CODE '034' (0/300 Vdc=4/20 mA)

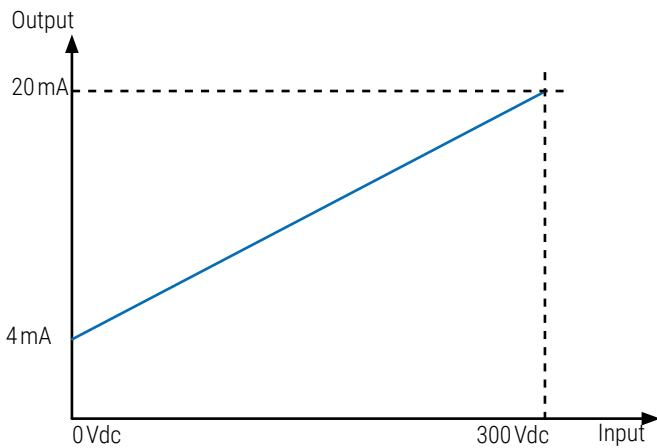

Selecting the predefined code '034' configures a range of 0/300Vdc=4/20mA, and the values configured are as indicated below:

input_low = 0Vdc	output_low = 4.00 mA
input_high = 300Vdc	output_high = 20.00 mA

Additionally, a process value can be scaled using the last three parameters of the **'Advanced Scaling' (Ad.Sc)** menu entry. The scaled process value can be accessed through the *'display information'* function (see section 13.5) or the *'messages'* function (see section 13.7).

- at the **'Process low' (Pr.Lo)** parameter, configure the process value associated to the low input signal value.
- at the **'Process high' (Pr.hi)** parameter, configure the process value associated to the high input signal value.
- at the **'Process decimal point' (Pr.dP)** parameter, configure the decimal point position for the process value.

Example: a 0/60mVdc signal from a shunt is associated to a 0/150.0Adc process value. Configure the process value to '0' and '150.0' ('Process low' = '0', 'Process high'='1500', 'Process decimal point'='xxx.x').

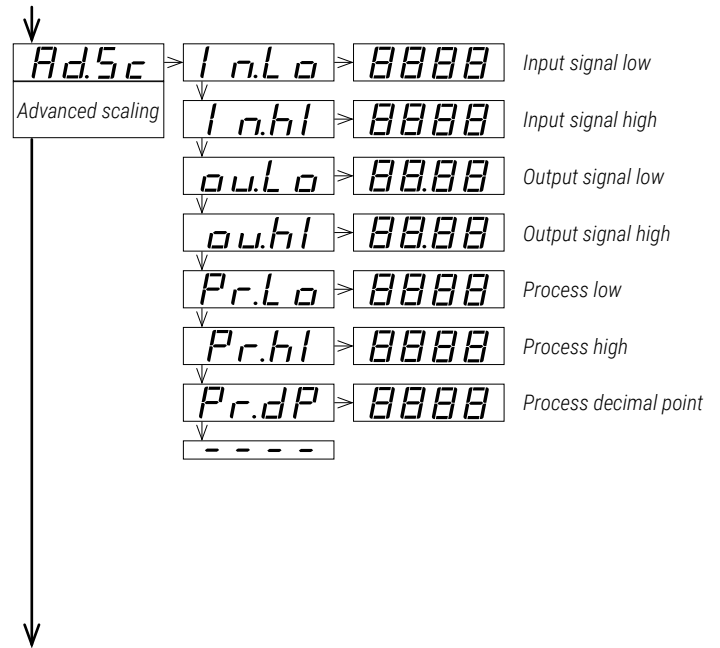
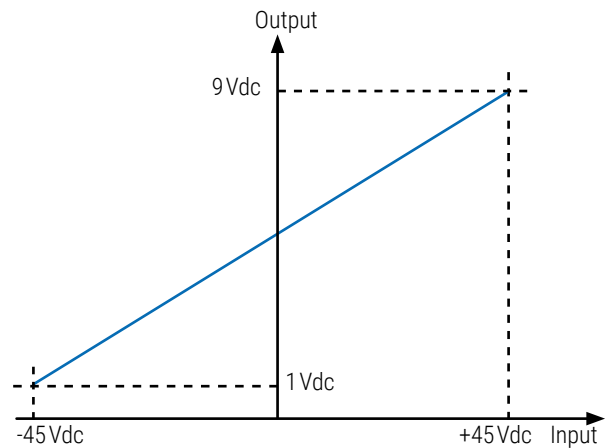

Table 20 | EXAMPLE FOR BIPOLAR RANGE



To configure a $\pm 45\text{Vdc}=1/9\text{Vdc}$ application, select code 137 (0/60Vdc=0/10Vdc) and then configure the parameters below:

input_low = -45.0 Vdc	output_low = +1.00 Vdc
input_high = +45.0 Vdc	output_high = +9.00 Vdc

13. Configuration menu (cont.)

13.5 Display information

At the **'Display information' (dISP)** menu select one parameter to read on display when the instrument is in *'normal mode'* of operation. If you need access to more than one information, see the *'messages'* function (see section 13.7) associated to front key **'LE'** (◀).

- select **'Input signal value' (InP.S)** to read the input signal value and the measurement units (for example : **'Inp Vdc 28.5'**).
- select **'Output signal value' (out.S)** to read the output signal value and the measurement units (for example : **'Out mA 12.40'**).
- select **'Label' (LABL)** to read the value configured at the *'label'* parameter (see section 13.8).
- select **'Process value' (Proc)** to read the process value as scaled at the process parameters (see section 13.4) (for example: **'Proc 1500'**).
- select **'Percentage' (Prct)** to read the percentage of signal, where '0' is the value assigned to the *'input signal low'* parameter, and '100' is the value assigned to the *'input signal high'* parameter (see section 13.4) (for example : **'Prct 23.5'**).

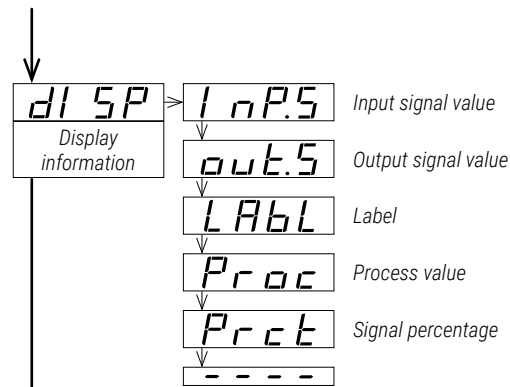

13.6 Key 'UP' ('force' menu)

The key **'UP'** (▲) at the front of the instrument gives access to a configurable list of functions (see section 10.4).

At the **'Key UP ('force' menu) (K.uP)** menu select which functions will be available when pressing the front key **'UP'** (▲). Select **'on'** to activate the desired functions.

- configure **'Force Low' (F.Lo)** to **'on'** to activate the *'Force low'* function menu entry.
- configure **'Force High' (F.hI)** to **'on'** to activate the *'Force high'* function menu entry.
- configure **'Force Set' (F.SET)** to **'on'** to activate the *'Force set'* function menu entry.

The functions configured to **'on'** are available at the *'force'* menu. See section 10.4 for a description on each function and how to operate them.

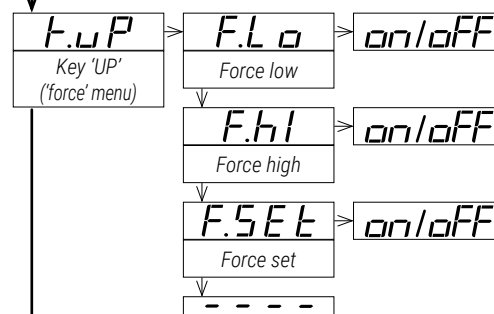

13. Configuration menu (cont.)

13.7 Key 'LE' ('messages' function)

The key 'LE' (◀) at the front of the instrument gives access to a configurable set of information messages.

At the 'Key LE (messages function)' (K.LE) menu, select the informations to be displayed when the front key 'LE' (◀) is pressed (see section 10.5). Select 'on' to activate each information.

- configure 'Input signal value' (InP.S) to 'on' to see the actual input signal value and units (for example: 'Inp Vac 48.7')
- configure 'Output signal value' (out.S) to 'on' to see the actual output signal value and units (for example: 'Out mA 08.3')
- configure 'Label' (LAbL) to 'on' to read the value configured at the 'label' parameter (see section 13.8).
- configure 'Process value' (Proc) to 'on' to read the process value as configured at the process parameters (see section 13.4) (for example: 'Proc 1500').
- configure 'Percentage' (Prct) to 'on' to see the actual percentage of signal, where '0' is the value assigned to the 'input signal low' parameter, and '100' is the value assigned to the 'input signal high' parameter (see section 13.4) (for example: 'Prct 23.5').

When more than one parameter is set to 'on', values will be displayed sequentially, in the same order as they are listed in the menu, with a middle dash '-' between them. When all information has been displayed, the instrument returns to 'normal mode' of operation.

13.8 'Tools' menu

The 'Tools' (tool) menu groups several functions.

- at the 'Eco mode' (Eco) parameter, define the time to wait before the display is powered off (while in 'normal mode' of operation). Default value is 60 seconds. Configure '0' to disable the function and maintain the display always on.
- at the 'SOS mode' (SoS) parameter select 'on' to activate the output signal to a predefined value. Select the value from 0 to 100% of the active output range (4/20mA or 0/10Vdc). To deactivate the 'SOS mode' select 'OFF'. See section 6 for more information on the 'SOS mode'.
- at the 'Label' (LAbL) parameter, define an alphanumerical value to be displayed on the display, when the instrument is in 'normal mode' of operation, or at the 'messages' function when the key 'LE' (◀) is pressed. The label can be used to identify the instrument with its own internal factory code. If more than four characters are needed, configure the 'Label2' (LbL.2) parameter. The total label value is the characters at 'label' followed by the characters at 'label2'. For additional information and a list of available characters, see section 7.
- at the 'On error' (on.Er) parameter, configure the behavior of the output signal, in case of hardware error at the input (see section 16).
 - select 'Output to high' (to.hI) to force the output signal to overrange to maximum value
 - select 'Output to low' (to.Lo) to force the output signal to underrange to minimum value
 - select 'Standard output' (StdR) to overrange output signal to maximum value in case of input signal overrange, and to underrange output signal to minimum value in case of input signal underrange.
- at the 'On 'SQ'' (on.Sq) parameter, configure the behavior of the

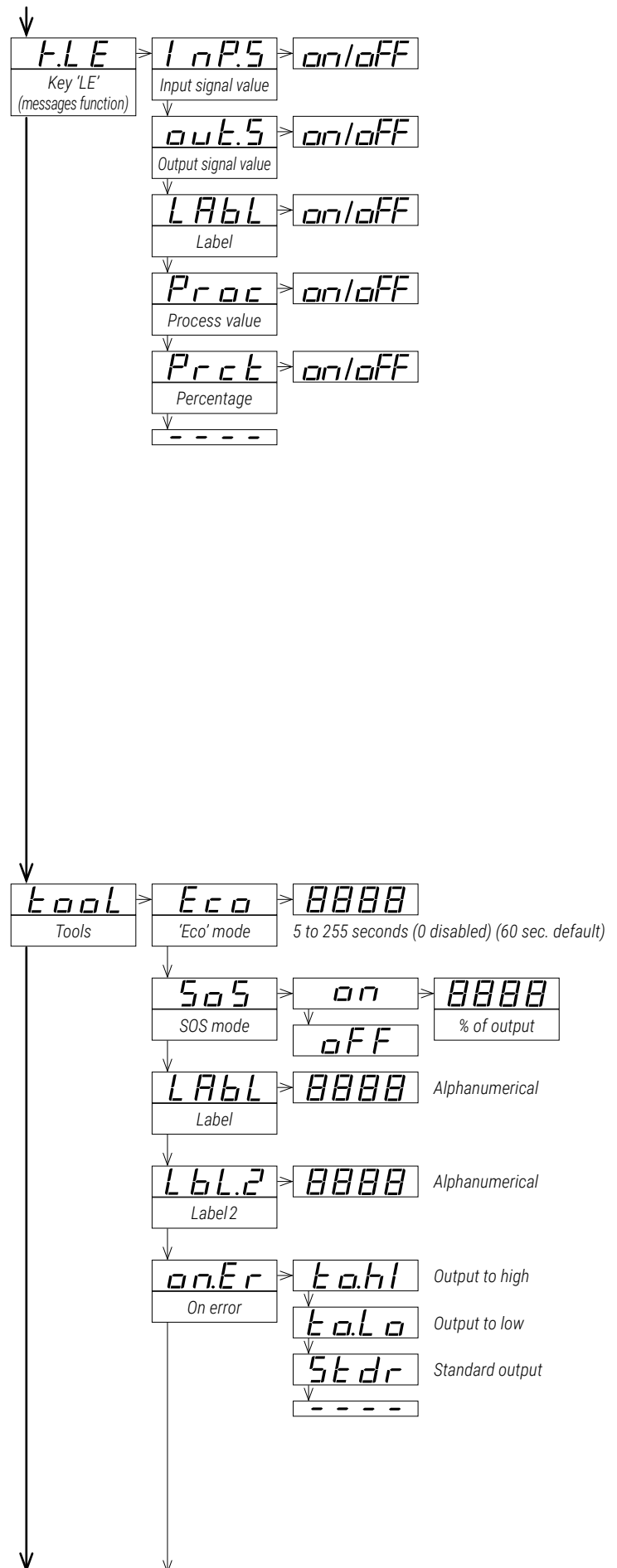

13. Configuration menu (cont.)

output signal when the operator is inside 'configuration menu' (see section 10.3).

- select '**Output to high**' (**to.hI**) to force the output signal to overrange to maximum value
 - select '**Output to low**' (**to.Lo**) to force the output signal to underrange to minimum value
 - select '**Hold output**' (**hoLd**) to hold the output signal while the operator remains inside 'configuration menu'.
 - at the '**Power filter**' (**P.FLt**) parameter, select a filter for specific power frequency rejection. The filter selection has an effect on the response times (see section 12). Applies only to DC signal ranges. AC signal ranges automatically configure this parameter to '50 and 60Hz filter' and this value can not be changed.
 - select '**No filter**' (**nonE**) to disable frequency rejection filters. This enables the fastest response time.
 - select '**50 Hz filter**' (**50.hZ**) to enable rejection to 50 Hz frequency.
 - select '**60 Hz filter**' (**60.hZ**) to enable rejection to 60 Hz frequency.
 - select '**50 and 60 Hz filter**' (**both**) to enable rejection to both 50 Hz and 60 Hz frequencies. This is the slowest response time.
 - at the '**Average filter**' (**AVr**) parameter, configure the recursive filter to be applied to measured input signal. The filter can be used to reduce oscillations on noisy signals. Configure the filter strength between '0' and '100'. The filter is stronger with higher values. Increasing the strength of the filter slows the response speed of the instrument. Value '0' disables the filter.
 - at the '**Dead band**' (**d.bnd**) parameter set a value between '0.0%' and '100.0%'. This is a percentage of the 'input signal high' parameter configured at the 'Advanced scaling' section. Input signals below this value, are treated as a '0'. This parameter applies to all measuring ranges. For bipolar ranges, the dead-band is bipolar and centered at '0'.
- example : instrument configured with code '012' (0/300 Vac = 4/20 mA) and 'input signal high' parameter modified to 250 Vac for an effective input - output relation of '0/250 Vac = 4/20 mA'. Configure the 'Dead band' parameter to '1.0' to set a dead band value of 2.5 Vac. All signals below 2.5 Vac will be treated as 0 Vac, and the output will be 4 mA.*
- the '**Version**' (**VEr**) parameter informs about the firmware version running in the instrument.
 - at the '**Password**' (**PASS**) parameter define a 4 digit code to block access to the 'configuration menu'. Activate the password to prevent access to the instrument configuration by non authorized personnel. To activate the 'Password' function select '**on**', enter the code and validate. The password will be requested when entering the 'configuration menu'. The password does not block access to the 'force' menu. To deactivate the password, set the password parameter to '**oFF**'.
 - at the '**Factory reset**' (**FAcT**) parameter select '**yes**' to activate the default factory configuration (see section 15 for a list of factory default parameters).

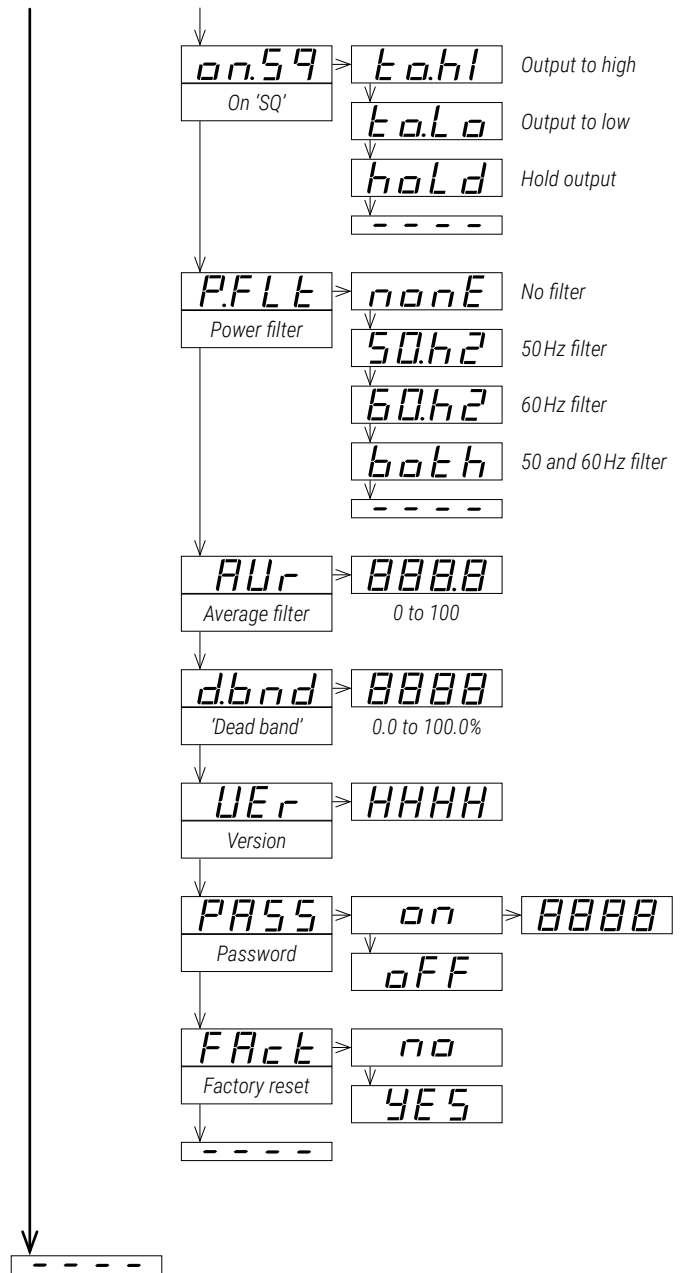

14. Full configuration menu

Press 'SQ' (■) for 1 second to access the 'configuration menu'. For a description on how to operate inside the menus see section 10. For a full vision of the 'configuration menu' structure see section 13.

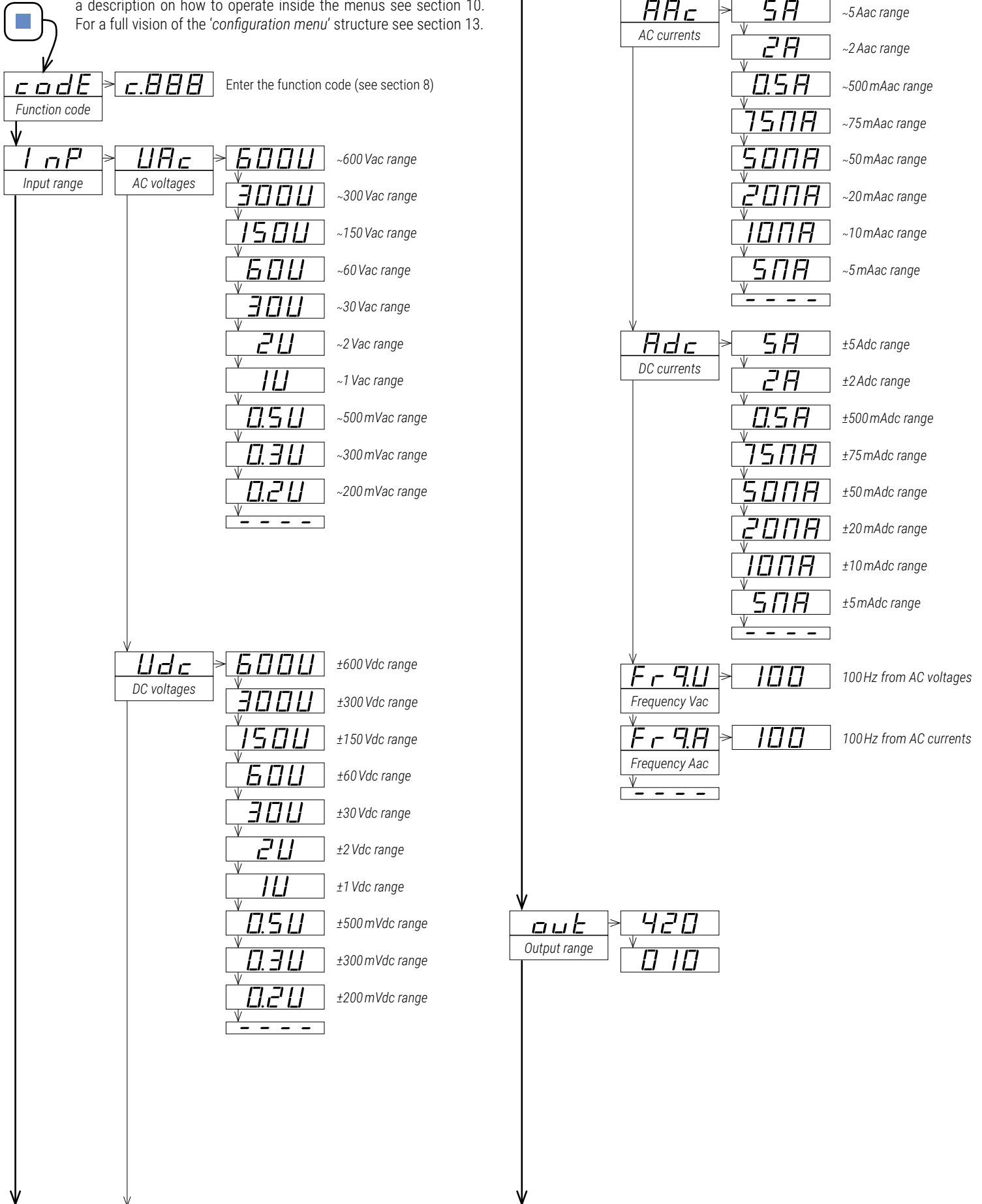

14. Full configuration menu (cont.)

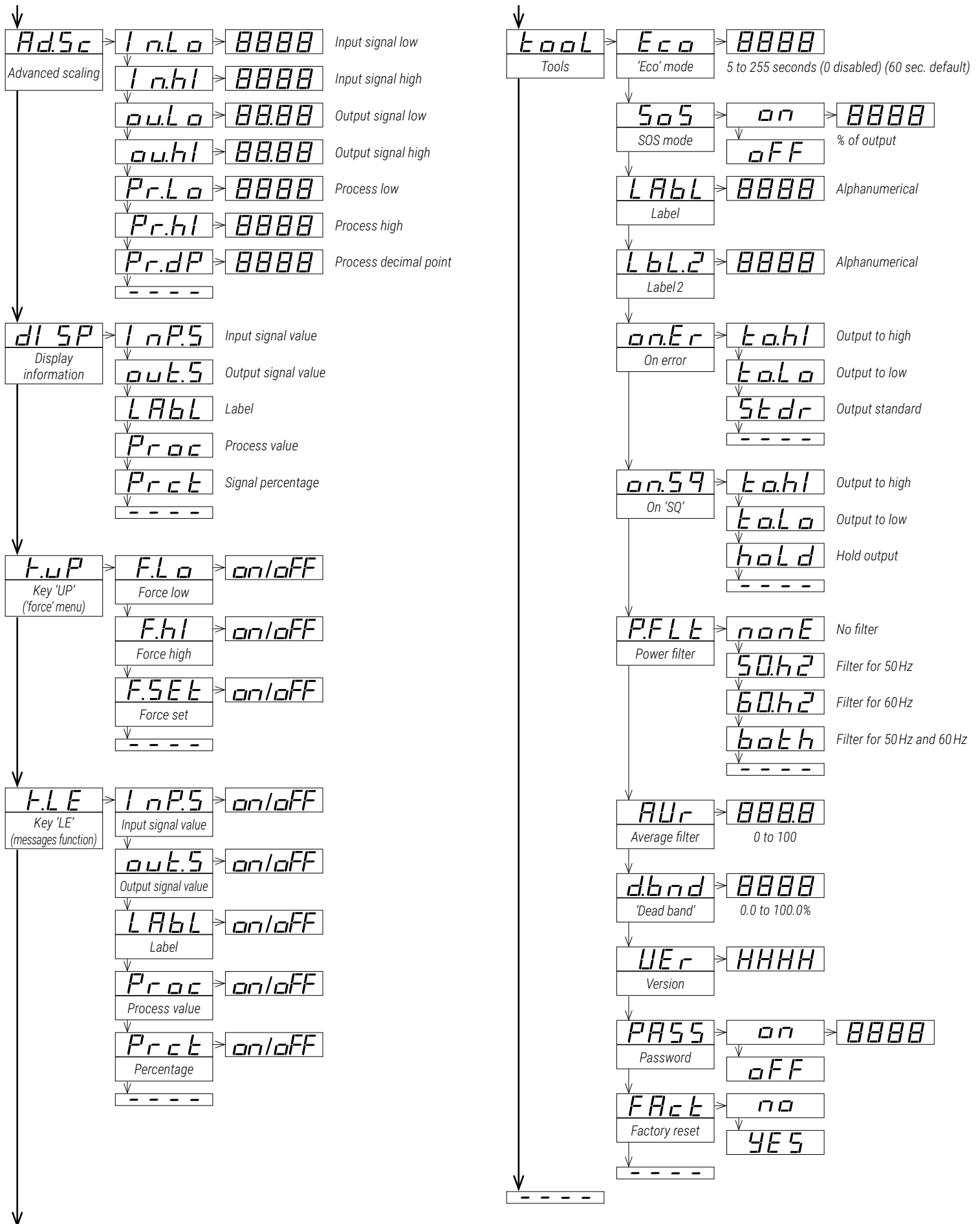

15. Factory default parameters

Function code (codE)	10	[c.010]
Input range (InP)	0/600	Vac
Output range (out)	4/20	mA
Advanced scaling (Ad.Sc)		
Input signal low (In.Lo)	0	[Vac]
Input signal high (In.hI)	600	[Vac]
Output signal low (ou.Lo)	4.00	[mA]
Output signal high (ou.hI)	20.00	[mA]
Process low (Pr.Lo)	0	
Process high (Pr.hI)	600	
Process decimal point (Pr.dP)	xxx	
Display information (dISP)	Input signal value (InPS)	
Key ' UP ' ('force' menu) (K.uP)		
Force low (F.Lo)	on	
Force high (F.hI)	on	
Force set (FSEt)	on	
Key ' LE ' ('messages' function) (K.LE)		
Input signal value (InPS)	off	
Output signal value (out.S)	on	
Label (LABL)	off	
Process value (Proc)	off	
Percentage (Prct)	off	
Tools (tool)		
'Eco' mode (Eco)	60	[seconds]
SOS mode (SoS)	off	
Label (LABL)	LABL	
Label 2 (LbL.2)	----	(disabled)
On error (on.Er)	to.hI	(output to maximum value)
On 'SQ' (on.Sq)	to.hI	(output to maximum value)
Power filter (P.FLt)	both	(50 and 60Hz filter)
Average filter (AVr)	0	(disabled)
Dead band (d.bnd)	0.0	(disabled)
Password (PASS)	off	(disabled)

RESET TO DEFAULT FACTORY PARAMETERS

To recover the instrument to default factory parameters, enter into 'configuration menu' and go to 'Tools' / 'Factory reset' and select 'yes'

- access the 'configuration menu' (press key '**SQ**' (■) for 1 second)
- press key '**UP**' (▲) to locate 'tools' and press '**SQ**' (■)
- parameter 'Eco mode' appears on display
- press key '**UP**' (▲) to locate 'Factory reset' and press '**SQ**' (■)
- value 'no' appears on display
- press key '**UP**' (▲) and 'Yes' appears on display
- press key '**SQ**' (■) to apply the factory reset
 - the leds light a round shape while the new configuration is applied
 - the start up message appears ('Vac 600')
 - the actual signal input value is displayed
- the instrument is in 'normal mode' of operation

16. Error codes

In case of error, the error code is shown flashing on the digits. The error code is not visible inside 'configuration mode' or inside the 'force' menu.

The error code remains active on display until the problem that caused the error is solved. In case of multiple error codes, solve the first problem to see the next active error code.

Table 21 | ERROR CODES

Error	Description
Er.01'	Password error. The password code entered is not correct.
Er.02'	Input hardware overrange. The input signal is higher than the maximum signal that can be measured.
Er.03'	Input hardware underrange. The input signal is lower than the minimum signal that can be measured.
Er.04'	Output hardware overrange. The output signal should be higher than the maximum output signal that can be generated.
Er.05'	Output hardware underrange. The output signal should be lower than the minimum output signal that can be generated.
Er.06'	Display overrange. The display value should be higher than the maximum value that can be displayed.
Er.07'	Display underrange. The display value should be lower than the minimum value that can be displayed.
Er.08'	Scaled input slope not valid. The values for 'Input signal low' (In.Lo) and 'Input signal high' (In.hI) can not be the same. Enter a different value to validate the parameter (see section 13.4).
Er.09'	Scaled output slope not valid. The values for 'Output signal low' (ou.Lo) and 'Output signal high' (ou.hI) can not be the same. Enter a different value to validate the parameter (see section 13.4).
Er.10'	Scaled process display slope not valid. The values for 'Process low' (Pr.Lo) and 'Process high' (Pr.hI) can not be the same. Enter a different value to validate the parameter (see section 13.4).

17. Precautions on installation



Check the documentation when you find this symbol, to know the nature of a potential danger and actions to prevent it.



Risk of electrical shock. Instrument terminals can be connected to dangerous voltage.



Instrument protected with double isolation. No earth connection required.



Instrument conforms to CE rules and regulations.

This instrument has been designed and verified conforming to the 61010-1 CE Security Regulation, for industrial applications. Installation of this instrument must be performed by qualified personnel only. This manual contains the appropriate information for the installation. Using the instrument in ways not specified by the manufacturer may lead to a reduction of the specified protection level. Disconnect the instrument from all external circuits before starting any maintenance and / or installation action.

The instrument does not have a general switch and will start operation as soon as power is connected. The instrument does not have protection fuse, the fuse must be added during installation.

The instrument is designed to be DIN rail mounted, inside a closed cabinet, protected from direct impacts. An appropriate ventilation of the instrument must be assured. Do not expose the instrument to excess of humidity. Maintain clean by using a humid rag and do NOT use abrasive products such as alcohols, solvents, etc. General recommendations for electrical installations apply, and for proper functionality we recommend : if possible, install the instrument far from electrical noise or magnetic field generators such as power relays, electrical motors, speed variators, ... If possible, do not install along the same conduits power cables (power, motor controllers, electrovalves, ...) together with signal and/or control cables. The use of shielded cables is recommended to prevent the coupling of environmental electromagnetic noise, connected to earth only one cable end side. Before proceeding to the power connection, verify that the voltage level available matches the power levels indicated in the label on the instrument. In case of fire, disconnect the instrument from the power line, fire alarm according to local rules, disconnect the air conditioning, attack fire with carbonic snow, never with water.



Conformity with security regulations EN-61010-1 requires a closed front cover. There is no need to open the front cover under normal usage or configuration. The output terminal prevents the front cover from opening. An open front cover may expose areas with dangerous voltages. Remove connections with dangerous voltages before opening. Only to be performed by qualified operators.

18. Warranty

This instrument is warranted against all manufacturing defects for a period of 36 months, as requested by the European legislation. This warranty does not apply in case of misuse or accident, and the scope of the warranty is limited to repair of the instrument, not being the manufacturer responsible for additional damages or additional costs. Within the warranty period and after examination by the manufacturer, the unit will be repaired or substituted when found to be defective.

19. CE declaration of conformity

Products **DR-I4E**

The manufacturer declares that the instruments indicated comply with the directives and rules indicated below.

Electromagnetic compatibility directive 2014/30/EU

Low voltage directive 2014/35/EU

ROHS directive 2015/863/EU

WEEE directive 2012/19/EU

Security rules EN-61010-1

Instrument Fixed, Permanently connected

Pollution degree 1 and 2 (without condensation)

Isolation Double

Overvoltage category 2

Category of measure CAT-II 300V

Electromagnetic compatibility rules EN-61326-1

EM environment Industrial

CISPR 11 Instrument Class A & Class B Group 1

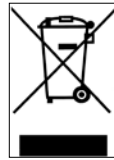

According to directive 2012/19/EU, electronic equipment must be recycled in a selective and controlled way at the end of its useful life.

WARRANTY/DISCLAIMER

OMEGA ENGINEERING, INC. warrants this unit to be free of defects in materials and workmanship for a period of **13 months** from date of purchase. OMEGA's WARRANTY adds an additional one (1) month grace period to the normal **one (1) year product warranty** to cover handling and shipping time. This ensures that OMEGA's customers receive maximum coverage on each product.

If the unit malfunctions, it must be returned to the factory for evaluation. OMEGA's Customer Service Department will issue an Authorized Return (AR) number immediately upon phone or written request. Upon examination by OMEGA, if the unit is found to be defective, it will be repaired or replaced at no charge. OMEGA's WARRANTY does not apply to defects resulting from any action of the purchaser, including but not limited to mishandling, improper interfacing, operation outside of design limits, improper repair, or unauthorized modification. This WARRANTY is VOID if the unit shows evidence of having been tampered with or shows evidence of having been damaged as a result of excessive corrosion; or current, heat, moisture or vibration; improper specification; misapplication; misuse or other operating conditions outside of OMEGA's control. Components in which wear is not warranted, include but are not limited to contact points, fuses, and triacs.

OMEGA is pleased to offer suggestions on the use of its various products. However, OMEGA neither assumes responsibility for any omissions or errors nor assumes liability for any damages that result from the use of its products in accordance with information provided by OMEGA, either verbal or written. OMEGA warrants only that the parts manufactured by it will be as specified and free of defects. OMEGA MAKES NO OTHER WARRANTIES OR REPRESENTATIONS OF ANY KIND WHATSOEVER, EXPRESS OR IMPLIED, EXCEPT THAT OF TITLE, AND ALL IMPLIED WARRANTIES INCLUDING ANY WARRANTY OF MERCHANTABILITY AND FITNESS FOR A PARTICULAR PURPOSE ARE HEREBY DISCLAIMED. LIMITATION OF LIABILITY: The remedies of purchaser set forth herein are exclusive, and the total liability of OMEGA with respect to this order, whether based on contract, warranty, negligence, indemnification, strict liability or otherwise, shall not exceed the purchase price of the component upon which liability is based. In no event shall OMEGA be liable for consequential, incidental or special damages.

CONDITIONS: Equipment sold by OMEGA is not intended to be used, nor shall it be used: (1) as a "Basic Component" under 10 CFR 21 (NRC), used in or with any nuclear installation or activity; or (2) in medical applications or used on humans. Should any Product(s) be used in or with any nuclear installation or activity, medical application, used on humans, or misused in any way, OMEGA assumes no responsibility as set forth in our basic WARRANTY/DISCLAIMER language, and, additionally, purchaser will indemnify OMEGA and hold OMEGA harmless from any liability or damage whatsoever arising out of the use of the Product(s) in such a manner.

RETURN REQUESTS/INQUIRIES

Direct all warranty and repair requests/inquiries to the OMEGA Customer Service Department. BEFORE RETURNING ANY PRODUCT(S) TO OMEGA, PURCHASER MUST OBTAIN AN AUTHORIZED RETURN (AR) NUMBER FROM OMEGA'S CUSTOMER SERVICE DEPARTMENT (IN ORDER TO AVOID PROCESSING DELAYS). The assigned AR number should then be marked on the outside of the return package and on any correspondence.

The purchaser is responsible for shipping charges, freight, insurance and proper packaging to prevent breakage in transit.

FOR **WARRANTY** RETURNS, please have the following information available BEFORE contacting OMEGA:

1. Purchase Order number under which the product was PURCHASED,
2. Model and serial number of the product under warranty, and
3. Repair instructions and/or specific problems relative to the product.

FOR **NON-WARRANTY** REPAIRS, consult OMEGA for current repair charges. Have the following information available BEFORE contacting OMEGA:

1. Purchase Order number to cover the COST of the repair,
2. Model and serial number of the product, and
3. Repair instructions and/or specific problems relative to the product.

OMEGA's policy is to make running changes, not model changes, whenever an improvement is possible. This affords our customers the latest in technology and engineering.

OMEGA is a trademark of OMEGA ENGINEERING, INC.

© Copyright 2019 OMEGA ENGINEERING, INC. All rights reserved. This document may not be copied, photocopied, reproduced, translated, or reduced to any electronic medium or machine-readable form, in whole or in part, without the prior written consent of OMEGA ENGINEERING, INC.

Where Do I Find Everything I Need for Process Measurement and Control? **OMEGA...Of Course!** *Shop online at omega.com*

TEMPERATURE

- ☑ Thermocouple, RTD & Thermistor Probes, Connectors, Panels & Assemblies
- ☑ Wire: Thermocouple, RTD & Thermistor
- ☑ Calibrators & Ice Point References
- ☑ Recorders, Controllers & Process Monitors
- ☑ Infrared Pyrometers

PRESSURE, STRAIN AND FORCE

- ☑ Transducers & Strain Gages
- ☑ Load Cells & Pressure Gages
- ☑ Displacement Transducers
- ☑ Instrumentation & Accessories

FLOW/LEVEL

- ☑ Rotameters, Gas Mass Flowmeters & Flow Computers
- ☑ Air Velocity Indicators
- ☑ Turbine/Paddlewheel Systems
- ☑ Totalizers & Batch Controllers

pH/CONDUCTIVITY

- ☑ pH Electrodes, Testers & Accessories
- ☑ Benchtop/Laboratory Meters
- ☑ Controllers, Calibrators, Simulators & Pumps
- ☑ Industrial pH & Conductivity Equipment

DATA ACQUISITION

- ☑ Communications-Based Acquisition Systems
- ☑ Data Logging Systems
- ☑ Wireless Sensors, Transmitters, & Receivers
- ☑ Signal Conditioners
- ☑ Data Acquisition Software

HEATERS

- ☑ Heating Cable
- ☑ Cartridge & Strip Heaters
- ☑ Immersion & Band Heaters
- ☑ Flexible Heaters
- ☑ Laboratory Heaters

ENVIRONMENTAL MONITORING AND CONTROL

- ☑ Metering & Control Instrumentation
- ☑ Refractometers
- ☑ Pumps & Tubing
- ☑ Air, Soil & Water Monitors
- ☑ Industrial Water & Wastewater Treatment
- ☑ pH, Conductivity & Dissolved Oxygen Instruments