

User's Guide

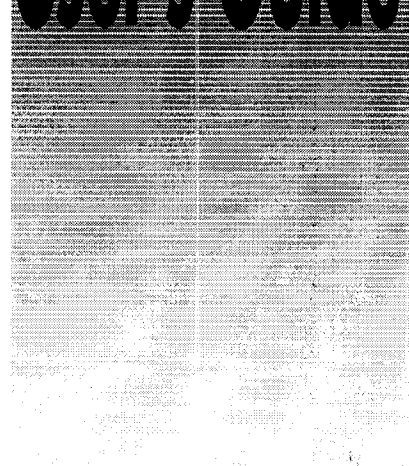

Shop online at



omega.com

e-mail: info@omega.com

For latest product manuals:

omegamanual.info

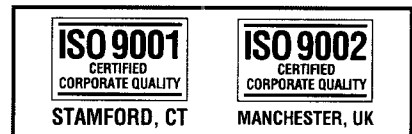

CN6221
Limit Controller



OMEGAnet® Online Service omega.com	Internet e-mail info@omega.com
-----------------------------------------------------	-------------------------------------------------

Servicing North America:

U.S.A.: One Omega Drive, P.O. Box 4047
ISO 9001 Certified Stamford, CT 06907-0047
TEL: (203) 359-1660
FAX: (203) 359-7700
e-mail: info@omega.com

Canada: 976 Bergar
Laval (Quebec) H7L 5A1, Canada
TEL: (514) 856-6928
FAX: (514) 856-6886
e-mail: info@omega.ca

For immediate technical or application assistance:

U.S.A. and Canada: Sales Service: 1-800-826-6342/1-800-TC-OMEGA®
Customer Service: 1-800-622-2378/1-800-622-BEST®
Engineering Service: 1-800-872-9436/1-800-USA-WHEN®

Mexico: En Español: (001) 203-359-7803
e-mail: espanol@omega.com
FAX: (001) 203-359-7807
info@omega.com.mx

Servicing Europe:

Czech Republic: Frystatska 184, 733 01 Karviná, Czech Republic
TEL: +420 (0)59 6311899
FAX: +420 (0)59 6311114
Toll Free: 0800-1-66342
e-mail: info@omegashop.cz

Germany/Austria: Daimlerstrasse 26, D-75392 Deckenpfronn, Germany
TEL: +49 (0)7056 9398-0
FAX: +49 (0)7056 9398-29
Toll Free in Germany: 0800 639 7678
e-mail: info@omega.de

United Kingdom: One Omega Drive, River Bend Technology Centre
ISO 9002 Certified Northbank, Irlam, Manchester
M44 5BD United Kingdom
TEL: +44 (0)161 777 6611
FAX: +44 (0)161 777 6622
Toll Free in United Kingdom: 0800-488-488
e-mail: sales@omega.co.uk

It is the policy of OMEGA Engineering, Inc. to comply with all worldwide safety and EMC/EMI regulations that apply. OMEGA is constantly pursuing certification of its products to the European New Approach Directives. OMEGA will add the CE mark to every appropriate device upon certification.

The information contained in this document is believed to be correct, but OMEGA accepts no liability for any errors it contains, and reserves the right to alter specifications without notice.

WARNING: These products are not designed for use in, and should not be used for, human applications.

Please read through this user's manual to ensure correct usage of the controller and keep it handy for quick reference.

CONTENTS

1. Notice	2
2. What is on the Front Panel?	3
3. Installing the Controller.....	4
4. Panel Cutout Dimensions and External Dimensions.....	5
5. Wiring	6
6. Hardware Specifications	8
7. Key Operations (Parameter Settings)	9
8. Limit Control Function.....	15
9. Troubleshooting.....	17

■ Checking Package Contents

Before using the product, check that its model & suffix codes are as you ordered.

Model and Suffix Codes

Model	Suffix code	Description
CN6221		Limit Controller (1/16 DIN size)
Control output	-R	Relay output (time-proportional PID or on/off control)
Option	-AL -DI -PV -C4	Alarm outputs (2 points) Digital input (1 point) PV retransmission output in 4 to 20mA Communication function

Check the package contents against the list below.

- Limit controller 1
- Mounting bracket 1 for CN6221
- User's manual (CN6221) 1

1. NOTICE

The following safety symbol is used both on the product and in this user's manual.



This symbol stands for "Handle with Care." When displayed on the product, the operator should refer to the corresponding explanation given in the user's manual in order to avoid injury or death of personnel and/or damage to the product. In the manual the symbol is accompanied by an explanation of the special care that is required to avoid shock or other dangers that may result in injury or loss of life.

The following symbols are used in this manual only.



NOTE

Indicates that operating the hardware or software in a particular manner may lead to damage or result in system failure.



IMPORTANT

Draws attention to information that is essential for understanding the operation and/or features of the product.





■ Exemption from Responsibility

Make sure that all of the precautions are strictly adhered to. Omega assumes no liability for any damage resulting from use of the instrument in contradiction to the precautions.

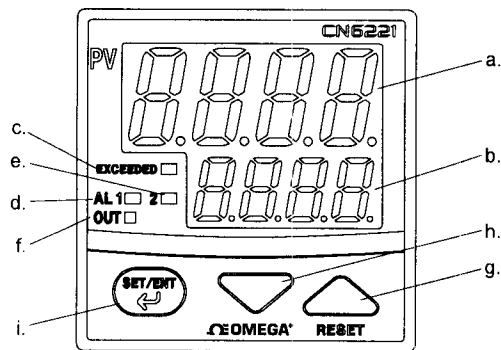
Also, Omega assumes no liability to any party for any loss or damage, direct or indirect, caused by the use or any unpredictable defect of the instrument.

2. WHAT IS ON THE FRONT PANEL?



	Name	Function
a.	PV display (red)	Indicates PV (measured value) and character information such as parameter codes and error codes.
b.	SP display (green)	Indicates SP (target setpoint) and parameter values.
c.	EXCEEDED lamp (green)	Lit while PV is exceeding SP value.
d.	Alarm 1 (AL1) lamp (red)	Lit when alarm 1 is activated.
e.	Alarm 2 (AL2) lamp (red)	Lit when alarm 2 is activated.
f.	Output (OUT) display lamp	<ul style="list-style-type: none"> Lit when PV exceeds SP value. This lamp does not go out until "confirming operation" is done (see Page 4). Note: Output relay contact is off when OUT lamp lights.
g.	Reset/Data change (up) key 	<ul style="list-style-type: none"> Pressing the key for 1 second or longer in "Operating display ① or ②" puts out Output(OUT) display lamp. (This operation is the "confirming operation".) Pressing the key for 1 second or longer in "confirmation display" resets "exceeded status(PV exceeds SP value)", "duration time" or max./min. PV value those CN6221 observed before. Pressing the key increases the data value. Holding down the key will gradually increase the speed of change.
h.	Data change (down) keys 	<ul style="list-style-type: none"> Pressing the  key decreases the data value. Holding down the key will gradually increase the speed of change.
i.	SET/ENT key (data registering key) (Indicated as simply the  key hereafter.)	<ul style="list-style-type: none"> Registers the data value changed using the data change keys. Switches between parameter setting displays sequentially. Pressing the key for 3 seconds or longer in the operating display retrieves the operating parameter setting display. Pressing the key for 3 seconds or longer in either an operating or setup parameter setting display transfers back to operating display 1.

3. INSTALLING THE CONTROLLER



CAUTION

To prevent electric shock, the source of power to the controller must be turned off when mounting the controller on to a panel.



NOTE

To install the controller, select a location where:

1. No-one may accidentally touch the terminals;
2. Mechanical vibrations are minimal;
3. Corrosive gas is minimal;
4. The temperature can be maintained at about 23°C with minimal fluctuation;
5. There is no direct heat radiation;
6. There are no resulting magnetic disturbances;
7. The terminal board (reference junction compensation element, etc.) is protected from wind;
8. There is no splashing of water; and
9. There are no flammable materials.

Never place the controller directly on flammable items.

If the controller has to be installed close to flammable items or equipment, be sure to enclose the controller in shielding panels positioned at least 150mm away from each side. These panels should be made of either 1.43mm thick metal-plated steel plates or 1.6mm thick uncoated steel plates.

- Mount the controller at an angle within 30° from horizontal with the screen facing upward. Do not mount it facing downward.

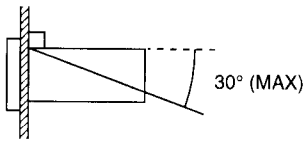
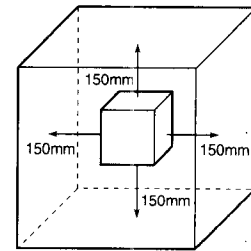

■ Mounting the Controller

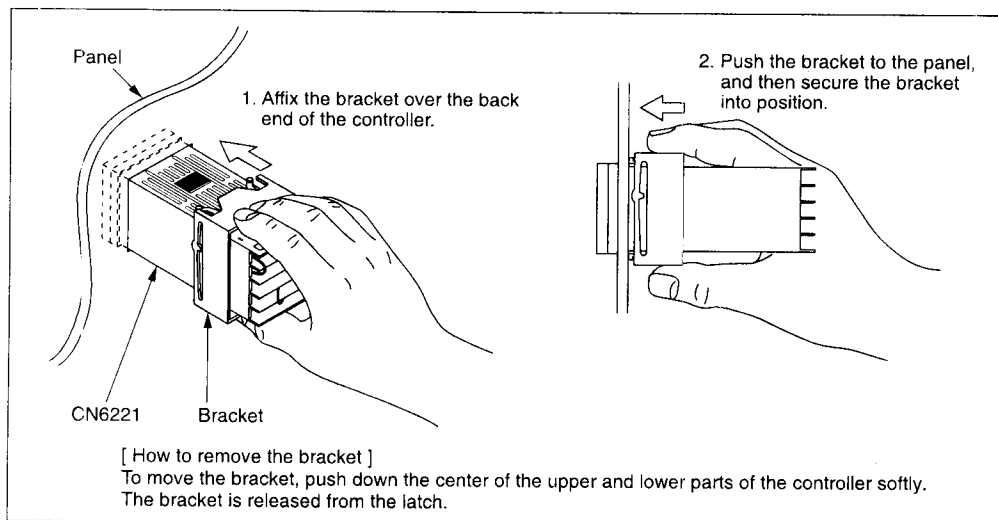

4. PANEL CUTOUT DIMENSIONS AND EXTERNAL DIMENSIONS

1. General Mounting

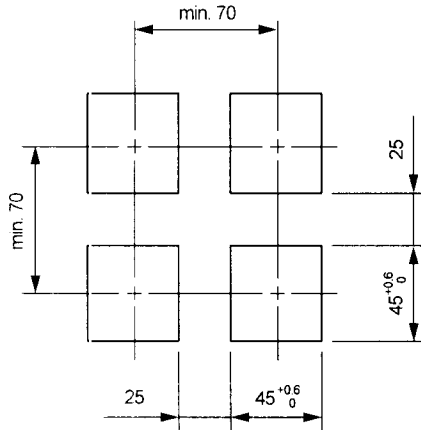

2. Side-by-side Close Mounting

(Splash-proof construction is unavailable)

Unit: mm

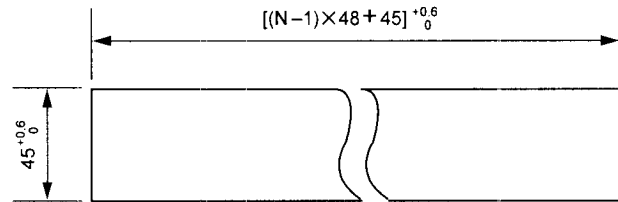

N is the number of controllers.
If $N \geq 5$, then measure the actual length.

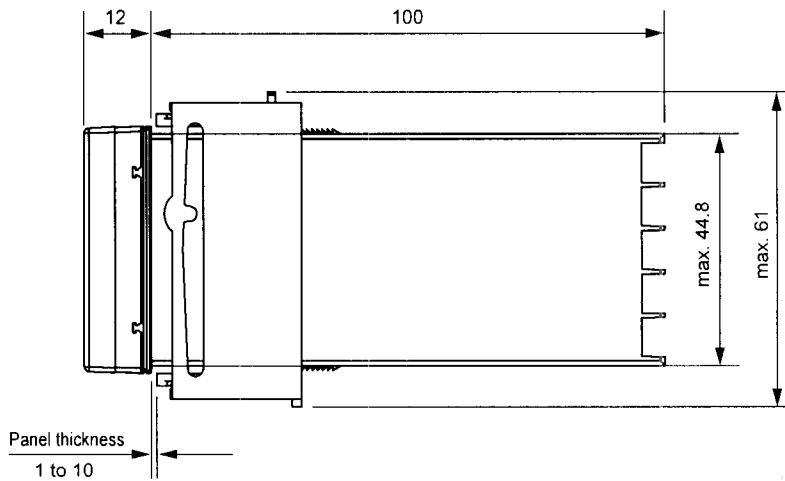
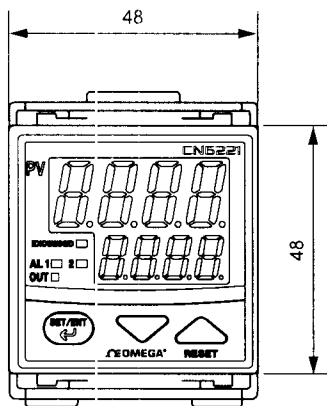
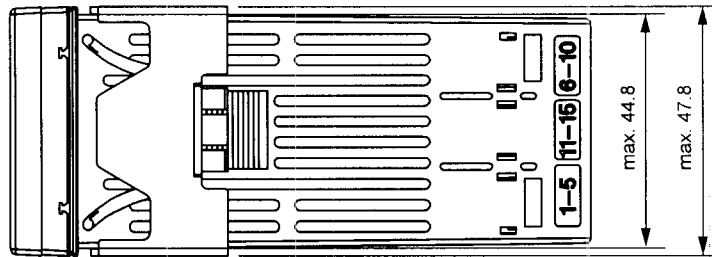

5. WIRING



CAUTION

- 1) Before you start wiring, turn off the power source and use a tester to check that the controller and cables are not receiving any power in order to prevent electric shock.
- 2) For safety, be sure to install a circuit breaker switch (of 5A and 100V AC or 220V AC, and that conforms to IEC60947) near the instrument so as to be operated easily, and clearly indicate that the device is used to de-energize the instrument.
- 3) Wiring should be carried out by personnel with appropriate electrical knowledge and experience.



NOTE

- 1) Use a single-phase power source. If the source has a lot of noise, use an isolation transformer for the primary side and a line filter (we recommend TDK's ZAC2205-00U product) for the secondary side. When this noise-prevention measure is taken, keep the primary and secondary power cables well apart. Since the controller has no fuse, be sure to install a circuit breaker switch (of 5A and 100V AC or 220V AC, and that conforms to IEC standards) and clearly indicate that the device is used to de-energize the controller.
- 2) For thermocouple input, use shielded compensating lead wires. For RTD input, use shielded wires which have low resistance and no resistance difference between the 3 wires. See the table given later for the specifications of the cables and terminals and the recommended products.
- 3) The control output relay cannot be replaced even though it has a limited service life (100,000 relay contacts for the resistance load). Thus, an auxiliary relay should be used so that the load can be turned on and off.
- 4) When using an inductive load (L) such as an auxiliary relay and solenoid valve, be sure to insert a CR filter (for AC) or diode (for DC) in parallel as a spark-rejecting surge suppressor to prevent malfunctions or damage to the relay.
- 5) When there is the possibility of being struck by external lightning surge, use the arrester to protect the instrument.

● Recommended Terminals

Use M3.5 screw-compatible crimp-on terminals with an insulating sleeve, as shown below.

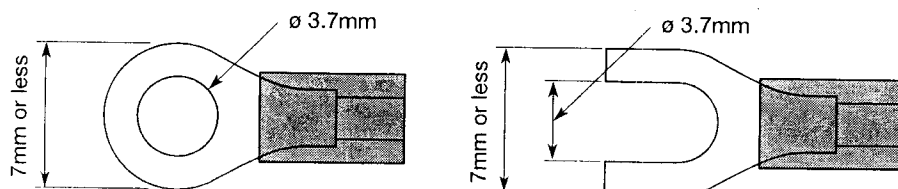

■ CN62:21 Terminal Arrangement

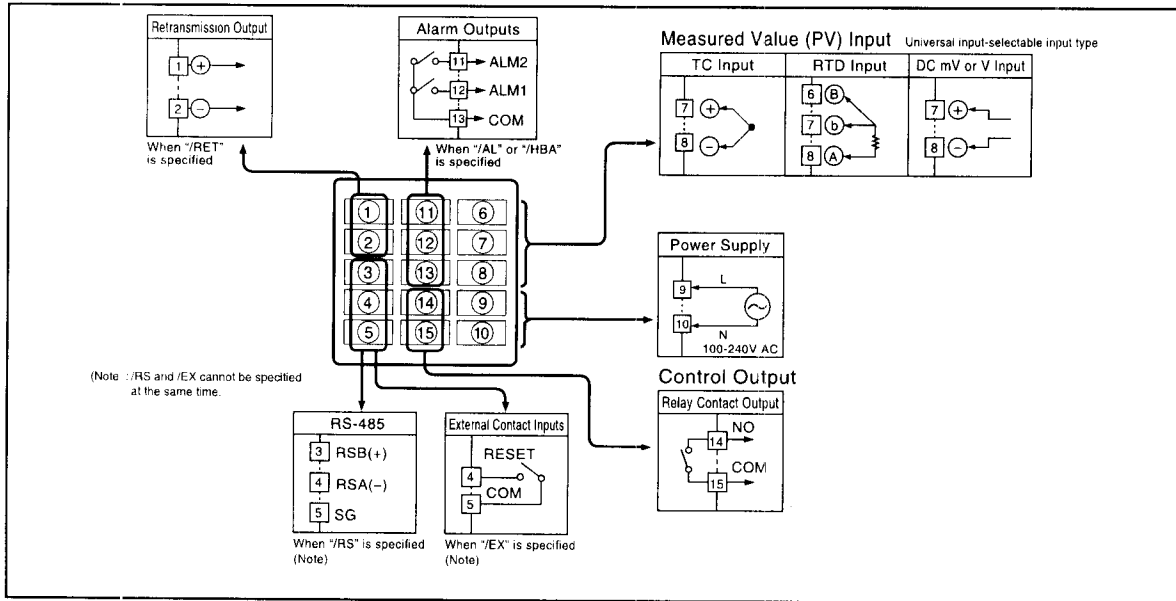

7. KEY OPERATIONS



NOTE

At power-on, the controller displays the operating display, but if the input range setting remains OFF, then "IN" appears. In this case, press the key to display the input range code you want to use, then press the key to register it. (Refer to the flowchart. (P.11))

- (1) You can move between parameter setting displays using the key.
- (2) To change the set value,
 - (i) Change the display value with the or key (the period flashes).
 - (ii) Press the key to register the setting.
- (3) At the operating display ① or ②, pressing the key for at least 3 seconds retrieves the operating parameter setting display.
- (4) At the operating parameter setting display, pressing the key for at least 3 seconds transfers back to the operating display ①. Registering the key-lock parameter LOC to "-1" retrieves the setup parameter setting display.
- (5) At the setup parameter setting display, pressing the key for at least 3 seconds transfers back to the operating display ①.

Note: If you cannot change the parameter setting value, check the key-lock parameter (LOC) setting.

NOTE

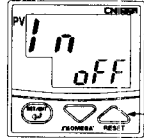

When "In" appears, press the key to display the input range code you want to use, then press the key to register it. After this operation, the controller shows the operating display ①.

● CN6221 Measured Input Range Codes List

Input type	Range (°C)		Range code (°C)	Range (°F)		Range code (°F)
	Unspecified		OFF			
Thermocouple	K	-270 to 1370°C	1	-300 to 2500°F	31	
		0.0 to 600.0°C	2	32.0 to 999.9°F	32	
		0.0 to 400.0°C	3	32.0 to 750.0°F	33	
		-199.9 to 200.0°C	4	-300 to 400°F	34	
	J	-199.9 to 999.9°C	5	-300 to 2100°F	35	
	T	-199.9 to 400.0°C	6	-300 to 750°F	36	
	E	-199.9 to 999.9°C	7	-300 to 1800°F	37	
	R	0 to 1700°C	8	32 to 3100°F	38	
	S	0 to 1700°C	9	32 to 3100°F	39	
	B	0 to 1800°C	10	32 to 3200°F	40	
	N	-200 to 1300°C	11	-300 to 2400°F	41	
	L	-199.9 to 900.0°C	12	-300 to 1600°F	42	
	U	-199.9 to 400.0°C	13	-300 to 750°F	43	
	Platinel 2	0 to 1390°C	14	32 to 2500°F	44	
RTD	Pt100	-199.9 to 850.0°C	15	-199.9 to 999.9°F	45	
		0.0 to 400.0°C	16	32.0 to 750.0°F	46	
		-199.9 to 200.0°C	17	-300 to 400°F	47	
		-19.9 to 99.9°C	18	No range	-	
	JPt100	-199.9 to 500.0°C	19	-199.9 to 999.9°F	48	
DC voltage	0 to 100mV	0.0 to 100.0	User-scalable			20
	0 to 5V					21
	1 to 5V					22
	0 to 10V					23

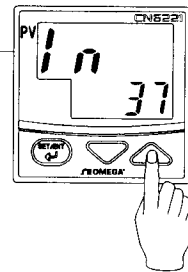

For example, to select thermocouple type E (°F), set the range code to 37.



CAUTION

To prevent electric shock, the controller should be mounted on the panel so that you do not accidentally touch the terminals when power is being applied.



IMPORTANT

The controller is shipped with the parameters set at the factory-set defaults. Check the default values against the “Parameter Lists” in the following page (P.12, 13), and change the parameter settings that need to be changed.

This following section explains how to set and register parameter values.

The procedure for changing SP (target setpoint) can be found on “Changing Setpoint (SP)”. You can set the other parameters in the same way.

There are no setup displays for parameters specific to functions, such as the optional alarm output functions, if they were not selected at ordering.

The setting of some parameters (such as the Alarm 1 type parameter AL1) determines whether the other parameters (Alarm 1 setpoint : A1) are displayed or not.

The Flowchart (P.11) will help you understand how this works.

■ Changing Setpoint (SP)

Step 1:

Confirm that the controller shows the operating display ① or ② during normal operation.

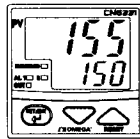

Step 2:

To enter the operating parameter setting display, press the key for at least 3 seconds. The display for the setpoint (SP) appears.

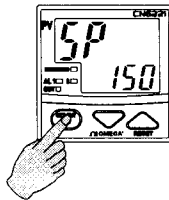

Press for at least 3 seconds.

Step 3:

Press the or key to change the current SP value to the required value. In this example, SP is changed to 200°C.

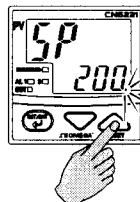

The period flashes while the value is being changed.

Step 4:

Press the key once to register the setting. SP is now changed. Another press of the key calls up the Alarm ① setpoint display. To return to the operating display ①, press the key for at least 3 seconds.

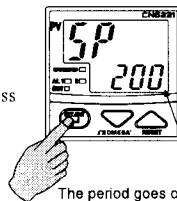

The period goes out.

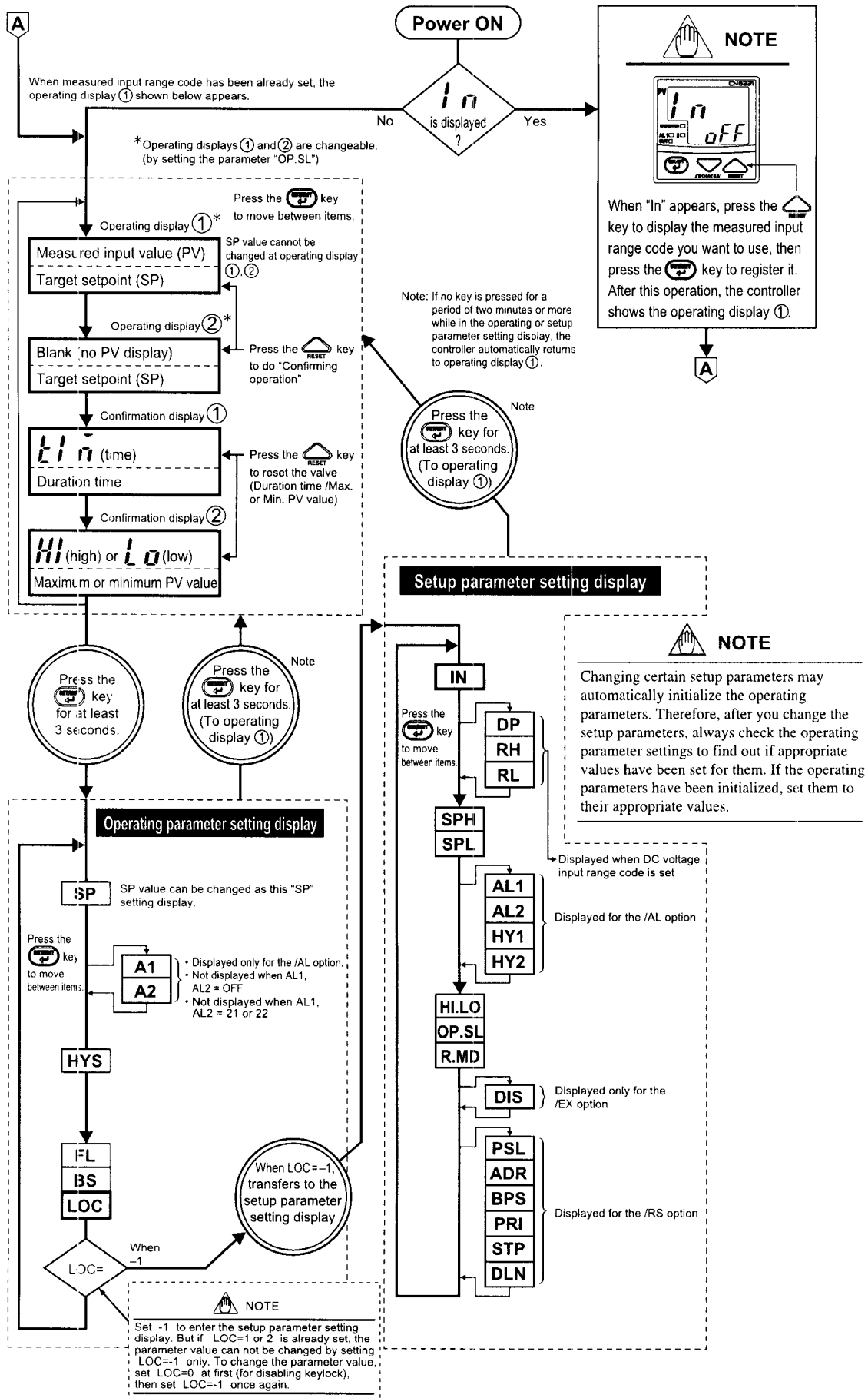

Parameter Lists

Numbers in () are the parameter setpoints that apply when the communication function is used. Ex. OFF(0), ON(1)

(1) Operating Parameters: Parameters changed rather frequently during operation.

Code	Name	Setting range and unit	Default	User setting
SP	SP Setpoint for limit alarm	Minimum value (SPL) to maximum value (SPH) Unit: °C/°F		
A1	A1 Alarm 1 setpoint	■ PV alarm Unit: °C/°F Setting range: minimum value to maximum value of measured input range (scale)	Max. value of measured input range (scale) (PV alarm)	
A2	A2 Alarm 2 setpoint	■ Deviation alarm Unit: °C/°F Setting range: -100 to 100% of the measured input range (scale) span	Min. value of measured input range (scale) (PV alarm)	
HYS	HYS Relay hysteresis for control output	0 to °C/°F to the temperature that corresponds to 100% of the measured input range (scale) span	0.5% of measured input range (scale) span	
FL	FL PV input filter	OFF(0), 1 to 120 seconds	OFF(0)	
BS	BS PV input bias	-100 to 100% of measured input range (scale) span	0% of measured input range (scale) span	
LOC	LoL Key lock	0: No key lock 1: Prevents operations from being changed except for the changing of SP 2: Prevents all parameter changing operations -1: Set "-1" to enter the setup parameter setting display. But if "LOC=1 or 2" is already set, the parameter value can not be changed by setting "LOC=-1" only. To change the parameter value, set "LOC=0" at first (for disabling keylock), then set "LOC=-1" once again.	0	

(2) Setup Parameters: Parameters rarely changed in normal use after once having been set.

Code	Name	Setting range and unit	Default	User setting
IN	IN Measured input type	1 to 23, and 31 to 48 (See input range code list on Page 9) OFF(0): No input (if no input type is specified at the time of ordering, you must set the input type)	OFF(0), or the input range code specified with order	
DP	DP Decimal point position of measured input	0: No decimal place (nnnn) (Displayed at voltage input) 1: One decimal place (nn.n) 2: Two decimal places (nn.nn) 3: Three decimal places (n.nnn)	1	
RH	RH Maximum value of measured input range (scale)	(RL + 1) to 9999 Unit: % (Displayed at voltage input)	100.0	
RL	RL Minimum value of measured input range (scale)	-1999 to (RH - 1) Unit: % (Displayed at voltage input)	0.0	
SPH	SPH Maximum value of setpoint range	(SPL + 1 to °C) to the maximum value of the measured input range (scale), Unit: °C/°F	Maximum value of measured input range (scale)	
SPL	SPL Minimum value of setpoint range	Minimum value of measured input range (scale) to (SPH - 1 to °C) Unit: °C/°F	Minimum value of measured input range (scale)	
AL1	AL1 Alarm 1 type	OFF(0) or a value from 1 to 22 (see the table of alarm function list)	1 (PV high limit alarm)	
AL2	AL2 Alarm 2 type	OFF(0) or a value from 1 to 22 (see the table of alarm function list)	2 (PV low limit alarm)	
HY1	HY1 Alarm 1 hysteresis	0 to 100% of measured input range (scale) span Unit: °C/°F	0.5% of measured input range (scale) span	
HY2	HY2 Alarm 2 hysteresis	0 to 100% of measured input range (scale) span Unit: °C/°F	0.5% of measured input range (scale) span	
HI.LO	HI.LO Limit control type	HI(0): High limit LO(1): Low limit	HI(0)	
OP.SL	OP.SL Operating display selection	0: PV and SP 1: Only SP (No PV display)	0	
R.M.D	R.M.D Restart mode	0: Limit output is ON at power on in any cases. 1: Limit output is OFF at power ON when PV doesn't exceed SP.	0	
DIS	DIS The way of confirming operation	KEY(0): By key operation DI(1): By digital input	KEY(0)	
PSL	PSL Protocol selection	0: PC-link communication 1: PC-link communication with sum check 2: Ladder communication 3: MODBUS in ASCII mode 4: MODBUS in RTU mode	0	
ADR	ADR Controller address	1 to 99 However, the number of controllers that can be connected per host device is 31 at the maximum.	1	
BPS	BPS Baud rate	2.4(0): 2400 bps 4.8(1): 4800 bps 9.6(2): 9600 bps	9.6(2)	
PRI	PRI Parity	NON(0): Disabled EVEN(1): Even parity ODD(2): Odd parity	EVN(1)	
STP	STP Stop bit	1 or 2 bits	1 bit	
DLN	DLN Data length	7 or 8 bits • 8 bits when ladder, MODBUS (RTU) • 7 bits when MODBUS (ASCII)	8 bits	

Alarm Function List

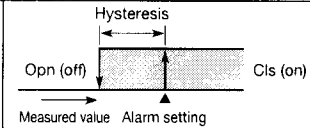
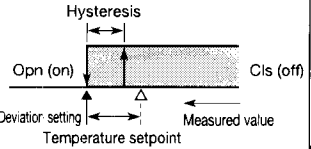
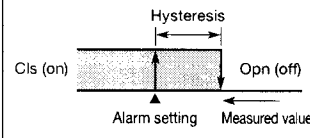
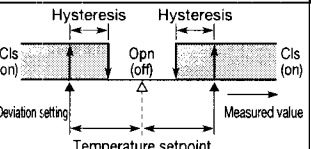
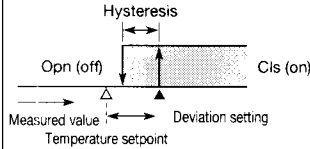
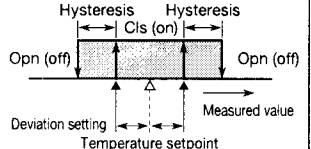
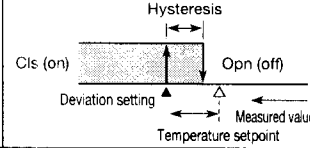
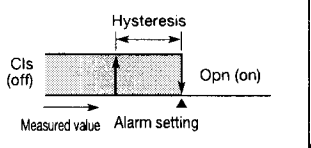
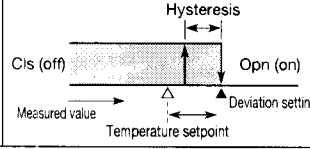
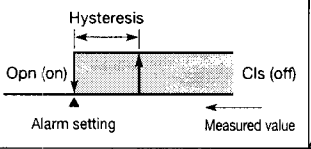
Alarm type	Action ("Opn" and "Cls" indicate that the relay contact is opened and closed; "on" and "off" indicate that the lamp is on and off; and white triangles indicate temperature control setpoints.)	Alarm type code		Alarm type	Action ("Opn" and "Cls" indicate that the relay contact is opened and closed; "on" and "off" indicate that the lamp is on and off; and white triangles indicate temperature control setpoints.)	Alarm type code	
		Closed contact during alarm	Open contact during alarm			Closed contact during alarm	Open contact during alarm
No alarm		OFF					
PV high limit		1 11 (See note.)		De-energized on deviation low limit		6 16 (See note.)	
PV low limit		2 12 (See note.)		Deviation high and low limit		7 17 (See note.)	
Deviation high limit		3 13 (See note.)		Deviation within-high-and-low-limit		8 18 (See note.)	
Deviation low limit		4 14 (See note.)		De-energized on PV high limit		9 19 (See note.)	
De-energized on deviation high limit			5 15 (See note.)	De-energized on PV low limit		10 20 (See note.)	
Fault diagnosis output	The contact is closed at input burnout.	21		FAIL output	The output contact is opened in the following events: <ul style="list-style-type: none"> • Program error • ROM error • RAM error • power failure • A/D converter error • RJC error • EEPROM error 		22

Note: The alarms numbered 1 to 10 have no waiting action, while alarms 11 to 20 have a waiting action.
The waiting action turns off the PV and deviation alarms that occur from the start of the control operation until a stable state is reached.

Waiting action

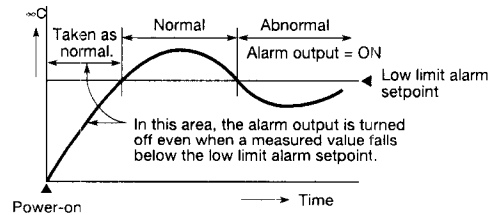

■ Description of Parameters

This section describes the parameter functions specific to the CN6221 limit controllers.

(The functions described in other sections of this manual and the general functions are not discussed.)

Parameter	Function
<p>Relay hysteresis for control output:</p> <p>HYS</p>	<p>For control, you can set a hysteresis around the on/off point (SP) to prevent chattering.</p>
<p>PV input filter</p> <p>FL</p>	<p>This function should be used when the PV display value may fluctuate greatly, for example, when the measured input signal contains noise. The filter is of the first-order lag type, and FL sets the time constant. If a larger time constant is set, the filter can remove more noise.</p>
<p>PV input bias</p> <p>BS</p>	<p>This function adds a bias value to the measured input value, and the result is used for display and control computation.</p> $\boxed{\text{PV value inside the controller}} = \boxed{\text{measured input value}} + \boxed{\text{PV input bias}}$ <p>This function is useful for carrying out fine adjustment when the PV value is within the required accuracy but it differs from the value obtained by other equipment.</p>
<p>Decimal point position of measured input</p> <p>DP</p>	<p>For DC voltage input, the input signal can be scaled for the particular engineering unit. For example, if you set the input type (IN) at range code 22, the initial range is 0.0 to 100.0.</p> <p>a. Using DP, set the decimal point position fit for the engineering unit you want to use. (In the example below, the 2 digits to the right of the decimal point)</p> <p>b. Next, register the scale values of the measured input scale using RH and RL. (In the example below, RH=10.00 and RL=0.00)</p>
<p>Maximum/minimum value of measured input range (scale)</p> <p>RH, RL</p>	
<p>Maximum/minimum value of target setpoint range</p> <p>SPH, SPL</p>	<p>Using the SPH and SPL parameters, you can limit the setting range of the target setpoint (SP) within the measured input range (scale).</p> <p>This function prevents SP from being mistakenly set at too large or too small a value (beyond the setting range).</p>

8. LIMIT CONTROL FUNCTION

■ Limit Control

When a measured value (PV) exceeds a setpoint (SP), "EXCEEDED" lamp lights, and "OUT" lamp turns ON (A). The limit output relay is de-energized then. "EXCEEDED" lamp turns off when PV goes into normal condition, while the output (OUT) display lamp stays on as it is (B). The output (OUT) display lamp turns off when a confirming operation is done by an operator (C). The way to confirm is pressing the  key (or by an external contact, according to the setting of setup parameter DIS). The confirming operation is not accepted during PV exceeds SP (D) (during EXCEEDED lamp lights*). State of output relay is de-energized whenever "OUT" lamp is on.

* Check the "HYS" value if the EXCEEDED lamp is not turn off when PV is lower than SP.

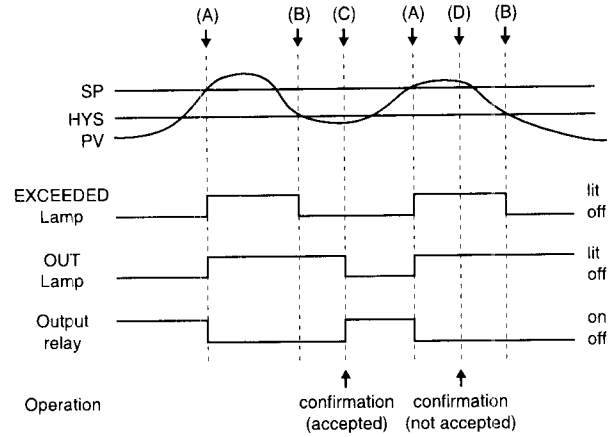

NOTE

The confirming operation cannot be done by communication (RS-485).

■ Confirming Operation

Do the confirming operation when you start limit control. This operation must be necessary every time when the controller is powered on. By the confirming operation, state of output relay is energized and the output (OUT) display lamp turns off, if the PV does not exceed SP.

Step 1:
Confirm that the controller shows the operating display ① and the output (OUT) display lamp lights.

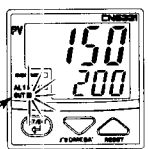

Step 2:
Press the  key for at least 1 second to turn off the output (OUT) display lamp. The confirming operation is now finished.

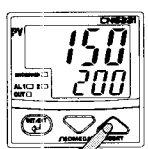

Note 1: The output (OUT) display lamp does not turn off during the EXCEEDED lamp lights.
Note 2: Check the "HYS" value if the EXCEEDED lamp is not turn off when PV is lower than SP.

■ Power On Status

The state of output relay at power-on can be set by a setup parameter restart mode "R.MD".

(1) When "R.MD" is set to 0.

The output relay is always de-energized (opened) at power-on, even if PV does not exceed SP (A). The output (OUT) display lamp is lit. After the confirming operation, state of output relay is energized (closed) and the output (OUT) display lamp turns off if the PV does not exceed SP (B).

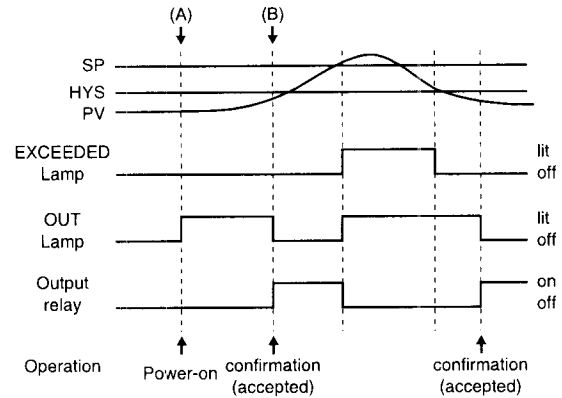

Fig.1 Power-on status of high limit control when R.MD = 0

(2) When "R.MD" is set to 1.

The state of output relay is energized (closed) and the output (OUT) display lamp turns off if the PV does not exceed SP at power-on.

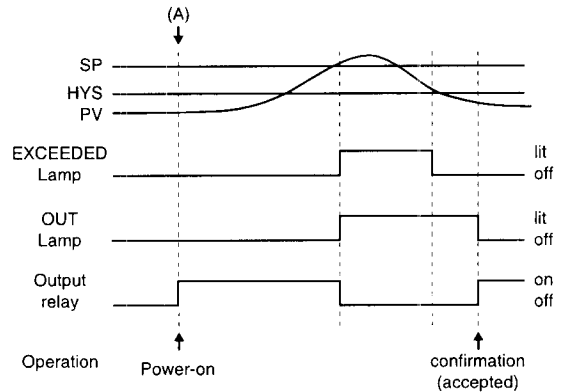



Fig.2 Power-on status of high limit control when R.MD = 1

■ Duration Time (Refer to the confirmation display ① in the flowchart on page 11)

The time while PV exceeds SP is counted and stored in the memory. It is displayed in the "TIME" in the confirmation display ①.

Display time range: 00.00 to 99.59

● How to RE:SET

- Push the  key for about one second to reset the duration time in the confirmation display ① where "TIME" is displayed. When the count is reset, "0.00" is displayed until PV exceeds SP again.
- The time count is reset when power is turned on.
- If PV exceeds SP while the old time count data is retained in the memory, the old data should be automatically reset, and the new time counting starts from "0.0".
- It is impossible to reset the time count while PV exceeds SP by any operation.
- Duration time cannot be reset by an external contact or communication (RS-485).

■ Maximum/Minimum Value

The maximum value or minimum value of PV is stored in the memory and displayed in the "HI" or "LO" display in the confirmation display ②.

When the control type is specified as high limit control, the maximum value is displayed in the "HI" display, and the control type is specified as low limit control, the minimum value is displayed in the "LO" display.

When the PV exceeds SP and then return to the normal status, Maximum/Minimum value is retained as it is, but when PV exceeds SP again, it is automatically reset and start taking new value for its maximum/minimum value.

● How to RE:SET

- Push the  key for about one second to reset the maximum/minimum value in the confirmation display ② where "HI" or "LO" is displayed. The value is reset, and the value immediately after the confirmation should be recognized as a maximum or minimum value.
- When the power is turned-on, the memory should be reset and the first PV should be recognized as maximum.
- Maximum/minimum value cannot be reset by an external contact or communication (RS-485).
- It is impossible to reset the maximum/minimum value while PV exceeds SP by any operation.

9. TROUBLESHOOTING

In the event of an abnormality, perform the following checks as outlined by the flowchart.

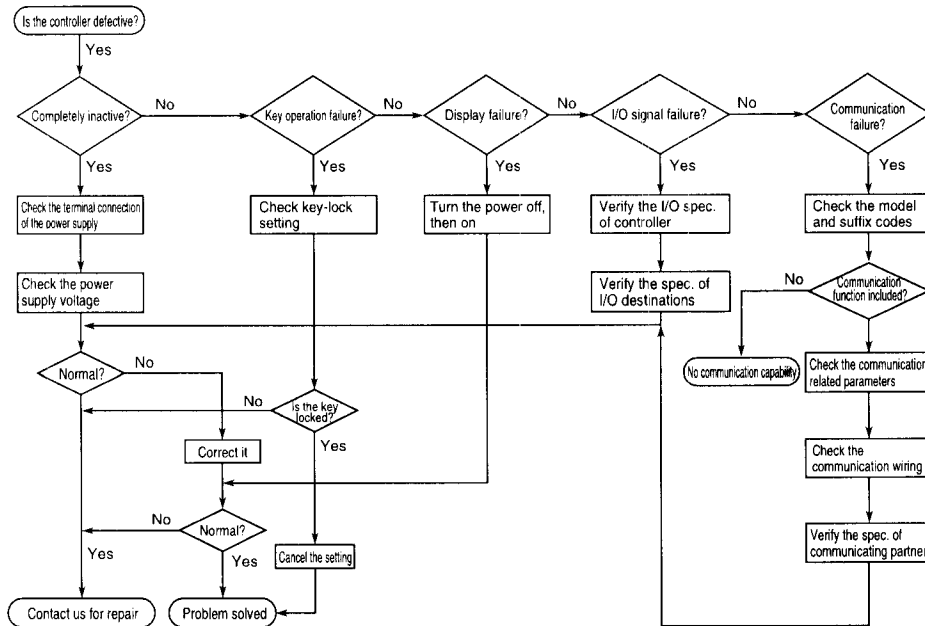

■ Error Display during Operation

(1) If the controller displays one of the following, carry out the appropriate remedy for the particular error.

Display	Error content	Remedy
<i>P.Er</i> P.Er	The parameter is abnormal	Check the settings of all the parameters and set them at their proper values.
<i>b.o</i> B.o	Input burnout	Check the sensor wiring and correct it.
<i>000</i> 000	PV over-scale (PV exceeds its effective range.)	Check the input type and range settings and correct them.
<i>UUU</i> UUU	PV under-scale (PV falls below its effective range.)	
Flashing period on PV display	Communication failure (for /RS option only)	Press any key to stop the flashing.

(2) The controller needs to be repaired if any of the indications in the table below appear.

In these cases, do not try to repair the controller yourself. Order a new controller or contact us for repair.

Display	Error content	Display	Error content
Unknown (at power-on)	CPU failure	Flashing "Err" (at power-on)	RAM or ROM failure
All extinguished (at power-on)	Power source failure	Flashing "Err" (during operation)	A/D converter failure, RJC failure, or EEPROM failure
"Err" (at power-on)	Calibration abnormal		

■ When Power Failure Occurred during Operation

- Momentary power failures of less than 20ms have no effect on the controller operation (i.e., normal operation continues).
- For power failures longer than 20ms, however the status will be as follows.
(The controller action at power recovery is the same as at power-on.)
 - Alarm action: Continues (but alarms with a waiting action enter the waiting state once)
 - Setting parameters : Maintained

WARRANTY/DISCLAIMER

OMEGA ENGINEERING, INC. warrants this unit to be free of defects in materials and workmanship for a period of **13 months** from date of purchase. OMEGA's WARRANTY adds an additional one (1) month grace period to the normal **one (1) year product warranty** to cover handling and shipping time. This ensures that OMEGA's customers receive maximum coverage on each product.

If the unit malfunctions, it must be returned to the factory for evaluation. OMEGA's Customer Service Department will issue an Authorized Return (AR) number immediately upon phone or written request. Upon examination by OMEGA, if the unit is found to be defective, it will be repaired or replaced at no charge. OMEGA's WARRANTY does not apply to defects resulting from any action of the purchaser, including but not limited to mishandling, improper interfacing, operation outside of design limits, improper repair, or unauthorized modification. This WARRANTY is VOID if the unit shows evidence of having been tampered with or shows evidence of having been damaged as a result of excessive corrosion; or current, heat, moisture or vibration; improper specification; misapplication; misuse or other operating conditions outside of OMEGA's control. Components in which wear is not warranted, include but are not limited to contact points, fuses, and triacs.

OMEGA is pleased to offer suggestions on the use of its various products. However, OMEGA neither assumes responsibility for any omissions or errors nor assumes liability for any damages that result from the use of its products in accordance with information provided by OMEGA, either verbal or written. OMEGA warrants only that the parts manufactured by the company will be as specified and free of defects. OMEGA MAKES NO OTHER WARRANTIES OR REPRESENTATIONS OF ANY KIND WHATSOEVER, EXPRESSED OR IMPLIED, EXCEPT THAT OF TITLE, AND ALL IMPLIED WARRANTIES INCLUDING ANY WARRANTY OF MERCHANTABILITY AND FITNESS FOR A PARTICULAR PURPOSE ARE HEREBY DISCLAIMED. LIMITATION OF LIABILITY: The remedies of purchaser set forth herein are exclusive, and the total liability of OMEGA with respect to this order, whether based on contract, warranty, negligence, indemnification, strict liability or otherwise, shall not exceed the purchase price of the component upon which liability is based. In no event shall OMEGA be liable for consequential, incidental or special damages.

CONDITIONS: Equipment sold by OMEGA is not intended to be used, nor shall it be used: (1) as a "Basic Component" under 10 CFR 21 (NRC), used in or with any nuclear installation or activity; or (2) in medical applications or used on humans. Should any Product(s) be used in or with any nuclear installation or activity, medical application, used on humans, or misused in any way, OMEGA assumes no responsibility as set forth in our basic WARRANTY/DISCLAIMER language, and, additionally, purchaser will indemnify OMEGA and hold OMEGA harmless from any liability or damage whatsoever arising out of the use of the Product(s) in such a manner.

RETURN REQUESTS/INQUIRIES

Direct all warranty and repair requests/inquiries to the OMEGA Customer Service Department. BEFORE RETURNING ANY PRODUCT(S) TO OMEGA, PURCHASER MUST OBTAIN AN AUTHORIZED RETURN (AR) NUMBER FROM OMEGA'S CUSTOMER SERVICE DEPARTMENT (IN ORDER TO AVOID PROCESSING DELAYS). The assigned AR number should then be marked on the outside of the return package and on any correspondence.

The purchaser is responsible for shipping charges, freight, insurance and proper packaging to prevent breakage in transit.

FOR **WARRANTY** RETURNS, please have the following information available BEFORE contacting OMEGA:

1. Purchase Order number under which the product was PURCHASED,
2. Model and serial number of the product under warranty, and
3. Repair instructions and/or specific problems relative to the product.

FOR **NON-WARRANTY** REPAIRS, consult OMEGA for current repair charges. Have the following information available BEFORE contacting OMEGA:

1. Purchase Order number to cover the COST of the repair,
2. Model and serial number of the product, and
3. Repair instructions and/or specific problems relative to the product.

OMEGA's policy is to make running changes, not model changes, whenever an improvement is possible. This affords our customers the latest in technology and engineering.

OMEGA is a registered trademark of OMEGA ENGINEERING, INC.

© Copyright 2007 OMEGA ENGINEERING, INC. All rights reserved. This document may not be copied, photocopied, reproduced, translated, or reduced to any electronic medium or machine-readable form, in whole or in part, without the prior written consent of OMEGA ENGINEERING, INC.

Where Do I Find Everything I Need for Process Measurement and Control? **OMEGA...Of Course!** *Shop online at omega.com*

TEMPERATURE

- Thermocouple, RTD & Thermistor Probes, Connectors, Panels & Assemblies
- Wire: Thermocouple, RTD & Thermistor
- Calibrators & Ice Point References
- Recorders, Controllers & Process Monitors
- Infrared Pyrometers

PRESSURE, STRAIN AND FORCE

- Transducers & Strain Gages
- Load Cells & Pressure Gages
- Displacement Transducers
- Instrumentation & Accessories

FLOW/LEVEL

- Rotameters, Gas Mass Flowmeters & Flow Computers
- Air Velocity Indicators
- Turbine/Paddlewheel Systems
- Totalizers & Batch Controllers

pH/CONDUCTIVITY

- pH Electrodes, Testers & Accessories
- Benchtop/Laboratory Meters
- Controllers, Calibrators, Simulators & Pumps
- Industrial pH & Conductivity Equipment

DATA ACQUISITION

- Data Acquisition & Engineering Software
- Communications-Based Acquisition Systems
- Plug-in Cards for Apple, IBM & Compatibles
- Datalogging Systems
- Recorders, Printers & Plotters

HEATERS

- Heating Cable
- Cartridge & Strip Heaters
- Immersion & Band Heaters
- Flexible Heaters
- Laboratory Heaters

ENVIRONMENTAL MONITORING AND CONTROL

- Metering & Control Instrumentation
- Refractometers
- Pumps & Tubing
- Air, Soil & Water Monitors
- Industrial Water & Wastewater Treatment
- pH, Conductivity & Dissolved Oxygen Instruments