

1 YEAR
WARRANTY



User's Guide

Shop online at

omega.com®

www.omega.com

e-mail: info@omega.com



**FSW-9000/FSW-90-R/
FSCN-90 Series
Liquid Flow Transmitter,
Sensor and Switch**



OMEGAnet® Online Service
www.omega.com

Internet e-mail
info@omega.com

Servicing North America:

USA:
ISO 9001 Certified One Omega Drive, Box 4047
Stamford CT 06907-0047
Tel: (203) 359-1660 FAX: (203) 359-7700
e-mail: info@omega.com

Canada:
976 Bergar
Laval (Quebec) H7L 5A1, Canada
Tel: (514) 856-6928 FAX: (514) 856-6886
e-mail: info@omega.ca

For immediate technical or application assistance:

USA and Canada: Sales Service: 1-800-826-6342 / 1-800-TC-OMEGA*
Customer Service: 1-800-622-2378 / 1-800-622-BEST*
Engineering Service: 1-800-872-9436 / 1-800-USA-WHEN*
TELEX: 996404 EASYLINK: 62968934 CABLE: OMEGA

Mexico: En Español: (001) 203-359-7803 e-mail: espanol@omega.com
FAX: (001) 203-359-7807 info@omega.com.mx

Servicing Europe:

Benelux: Postbus 8034, 1180 LA Amstelveen, The Netherlands
Tel: +31 (0)20 3472121 FAX: +31 (0)20 6434643
Toll Free in Benelux: 0800 0993344
e-mail: sales@omegaeng.nl

Czech Republic: Frystatska 184, 733 01 Karvina, Czech Republic
Tel: +420 (0)59 6311899 FAX: +420 (0)59 6311114
Toll Free: 0800-1-66342 e-mail: info@omegashop.cz

France: 11, rue Jacques Cartier, 78280 Guyancourt, France
Tel: +33 (0)1 61 37 2900 FAX: +33 (0)1 30 57 5427
Toll Free in France: 0800 466 342
e-mail: sales@omega.fr

Germany/Austria: Daimlerstrasse 26, D-75392 Deckenpfronn, Germany
Tel: +49 (0)7056 9398-0 FAX: +49 (0)7056 9398-29
Toll Free in Germany: 0800 639 7678
e-mail: info@omega.de

United Kingdom: One Omega Drive, River Bend Technology Centre
ISO 9002 Certified Northbank, Irlam, Manchester
M44 5BD United Kingdom
Tel: +44 (0)161 777 6611 FAX: +44 (0)161 777 6622
Toll Free in United Kingdom: 0800-488-488
e-mail: sales@omega.co.uk

It is the policy of OMEGA to comply with all worldwide safety and EMC/EMI regulations that apply. OMEGA is constantly pursuing certification of its products to the European New Approach Directives. OMEGA will add the CE mark to every appropriate device upon certification.

The information contained in this document is believed to be correct, but OMEGA Engineering, Inc. accepts no liability for any errors it contains, and reserves the right to alter specifications without notice.

WARNING: These products are not designed for use in, and should not be used for, human applications.

Introduction 4
Features & Dimensions 5
Handling 6
Installation 7
Wiring diagram 8
Calibration 9
Maintenance 10
Technical specifications 11
Trouble shooting 12

FSW-9000 - Power Supply: 24VDC Analog 4-20mA Output and PNP/NPN Switch Output

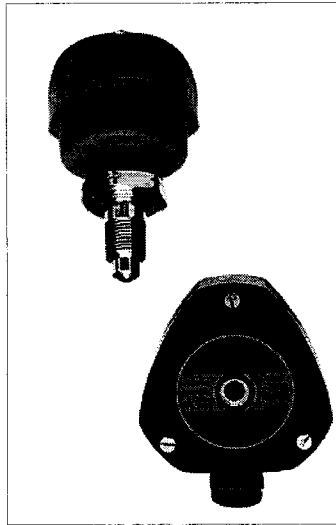

The FSW-9000 model is a flow switch monitor that measures the velocity of the flow. It is ideal for use in measurement and control applications. The FSW-9000 provides two output options; a 4-20mA output, the electronics module converts the signal from the probe to a 4-20mA analog output, which can be used to indicate flow rate. For the PNP/NPN output, the measured flow rate is compared to the set point value selected by the user and the switch changes state once the set point value has been achieved.

A chain of 8 LED's gives the user a visual indication of the flow rate as well as set point status, and one dichromatic LED indicates switch point status. In addition, if there is a problem with the unit, the 8 LED's will flash continuously providing troubleshooting information.

FSW-91-R Sensor + FSCN-90 Flow Switch Relay

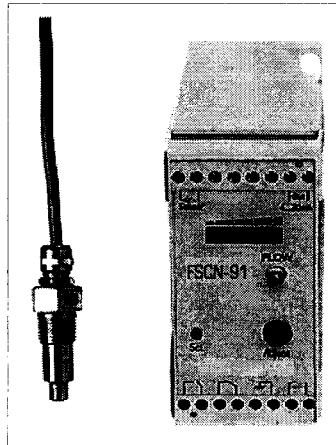

The **FSW-91-R** is very similar to the FSW-9000 with one main difference: The sensor is separate from the electronics and it does not have an enclosed housing. This gives the FSW-91-R the ability to be installed in very small pipes, such as 3/8" (9.5 mm) in diameter and be remotely controlled by the FSCN-91 relay. The FSW-91-R is the ideal solution when there is not a lot of space to install even a compact unit or when there is a need for a mounted relay.

Features and Dimensions



- Simple to install
- No moving parts-maintenance free reliability
- Maximum working pressure of 4,500 PSI (300 bar).
- Fast response time.
- Excellent low flow sensitivity
- Can be coated for aggressive mediums
- Available in EX-Proof version
- Available in threaded, sanitary and adjustable
- Insertion length connections

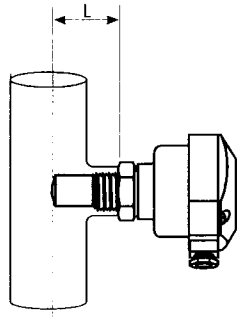
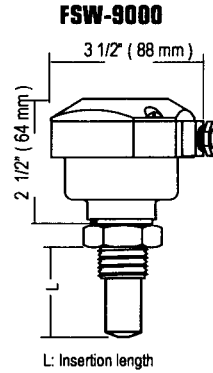

Code

- L = 1 3/8" (35mm)
- L = 2" (50mm)
- L = 3" (75mm)

Insertion length(suggestion)

- For pipes up to 1" diameter
- For pipes up to 3" diameter
- For pipes over 3" diameter

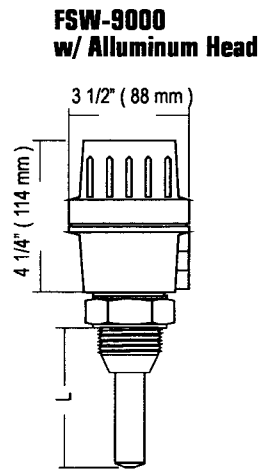
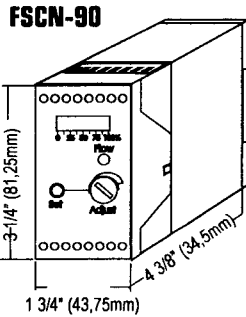
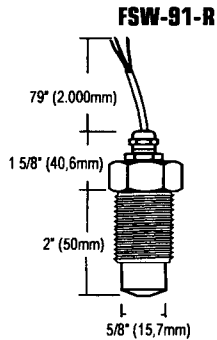

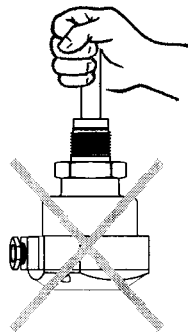

Do not hold
FSW-9000 by the sensor

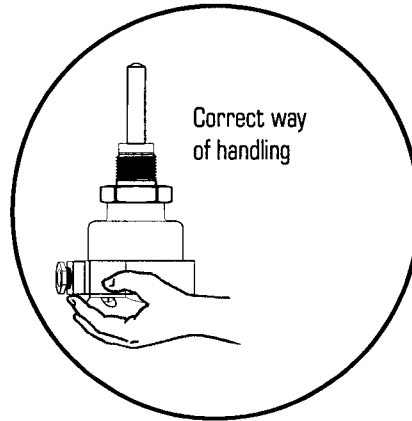

Correct way
of handling

Do not alter or bend the shape of the sensor

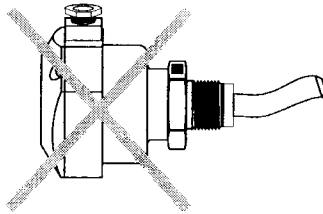

Pre-Installation Checks:

- 1) - Before installing the FSW-9000, check if the wire connections are correct and that the available power supply is compatible with the FSW-9000.
- 2) - Check if the operating pressure and temperature of the process corresponds to the FSW-9000.

Installation:

The FSW-9000 may be installed in a pipe or tank using the thread or connection provided. This location must be free of turbulence or vortices. Use only the hexagon when tightening to achieve a seal, do not use the body. The body should be rotated after tightening to leave the cable gland in a suitable orientation.

The FSW-9000 is not affected by its fixing position, so it may be installed at any angle into the pipe. However, it is recommended that with horizontal pipe runs the sensor should be installed on the side, into the middle of the pipe. In vertical pipes, the FSW-9000 should be installed when there is flow in an upward direction against gravity.

Care should be taken when installing the sensor that the probe extends clear of the pipe's internal wall and that it is fully immersed into the flow. In pipes with smaller diameters, some care should also be taken that the sensor is not screwed too far into the line. In both cases, if the installation is not correct the FSW-9000's performance may contain measurement errors.

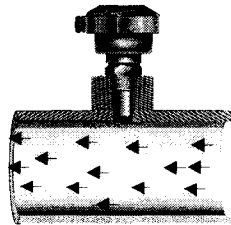
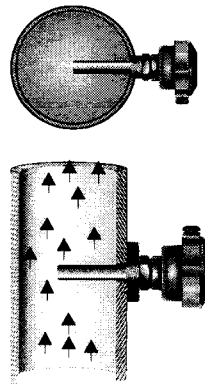
Incorrect**Correct**

FSW-9000

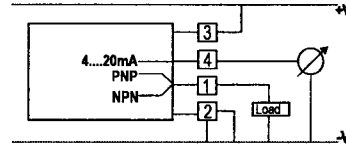
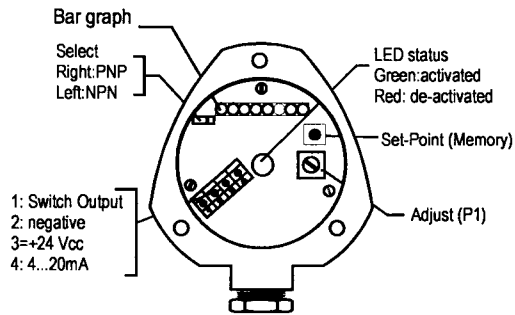

FSCN-91

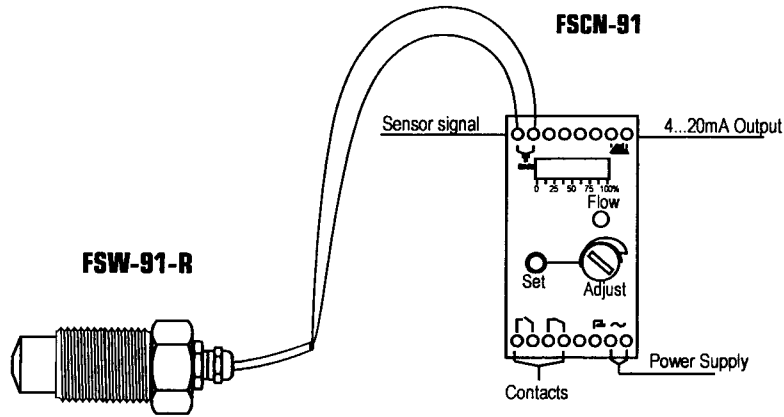

(Range 0.04 to 2.0 m/s):

- 1) - Remove the housing lid. (Note: the screws are self-retaining.)
- 2) - Start the power supply and wait 2 minutes until the FSW-9000 is active and can achieve a stability point. During start-up of the FSW-9000, the central flow LED will blink yellow.
- 3) - Let the regular or desired flow rate achieve its point of normal operation.
- 4) - With the pipe completely full of liquid and no flow (velocity = 0), turn the potentiometer totally counter-clockwise to its far left-hand and adjust 4-20mA.
Note: Any air gaps will cause inaccuracies in the measurement of the fluid velocity.
- 5) - If the process requires a 4/20-mA output with low flow, just maintain this flow during calibration remembering that this value can shift up to 25% from the 0.04 range.
- 6) - Press the SET button to store the value.
- 7) - The central flow LED will blink green for a few seconds. Wait until it stops blinking and turns red.
Note: If any error occurs (i.e. the LED doesn't blink) press SET button again.
- 8) - Start up the flow in the pipe. The flow velocity range must be over 75% of the 0.04 range
- 9) - Turn the potentiometer clockwise to its far right hand and adjust 20 mA.
- 10) - Press the SET button to store the value.
- 11) - The central flow LED will blink green for a few seconds. Wait until it stops blinking and turns red. At this point, the chain of 8 LEDs will be on.
Note: If any error occurs (i.e. the LED doesn't blink) press the SET button again.
- 12) - After calibrating the FSW-9000, adjust the potentiometer to the desired switch point.
- 13) - Use the chain of 8 LEDs to find the correct switch point.
- 14) - Use the following formula to check that the process velocity falls into this measuring Range:

V = velocity (m/s)

Q = flow rate (m³/s)

D = internal pipe diameter

$$V = \frac{1.27 \times Q}{D^2}$$

Note: The FSW-9000 is factory calibrated to a nominal range (0.04 to 2 m/s). To restore this calibration, simply turn the potentiometer counter-clockwise to the far-left hand and press the SET button. While the central flow LED is blinking, turn the potentiometer clockwise. In the event of a power failure the calibration program will store values for maximum and minimum flows for up to 10 years.

Periodic visual inspection of the FSW-9000 is required to check for corrosion or deposit build-up. If deposits are found, clean the sensor to ensure optimum performance.

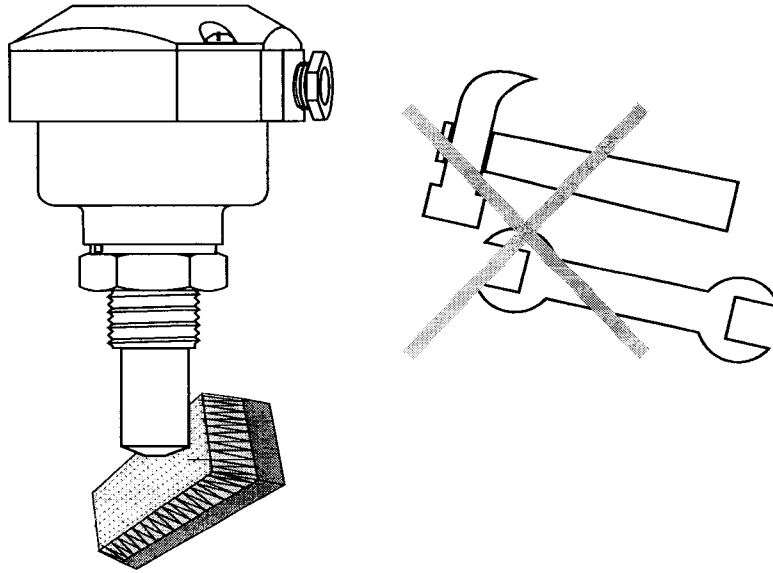

When cleaning the Flow Switch, use a soft brush or any other similar object.

MODELS	FSW-9000	FSW-91-R	FSW-9000 w/ Aluminum Head
Application	Flow for liquids	Flow for liquids	Flow for liquids
Operating Voltage	DC - 24 Vdc +/- 10%	DC - 24 Vdc +/- 10% AC - 85...240Vac and 125 Vdc	DC - 24 Vdc +/- 10%
Current Consumption	Max. 1VA	Max. 1VA	Max. 1VA
Output	4-20mA and transistor NPN/ PNP (400mA)	4-20mA and relay (SPDT)	4-20mA and transistor NPN/ PNP (400mA)
Set point range	0.04 to 2m/s - water 0.1 to 4m/s - oil	0.04 to 2m/s - water 0.1 to 4m/s - oil	0.04 to 2m/s - water 0.1 to 4m/s - oil
Electrical connection	Cable gland or M12 connector	Cable gland with 6,57ft (2000mm) cable or M12 connector	1/2" or 3/4" NPT
Operating Temperature	14 to 176° F (-10 to 80°C) sanitary option to 248°F (120°C)	Sensor: 14 to 176° F (-10 to 80°C) sanitary option to 248°F (120°C)	14 to 176° F (-10 to 80°C)
Gradient Temperature	not affected	not affected	not affected
Accuracy	Typical +/- 5% setpoint	Typical +/- 5% setpoint	Typical +/- 5% setpoint
Response time	3 to 10 seconds	3 to 10 seconds	3 to 10 seconds
Repeatability	+/- 1% setpoint	+/- 1% setpoint	+/- 1% setpoint
Flow rate indication	8 LED's bar graph	8 LED's bar graph	8 LED's bar graph
Process connection	½" to 1 1/2" BSP or NPT, adjustable, sanitary connections	1/2" BSP or NPT, adjustable, sanitary connections	½" to 1" NPT
Wetted material	316 SS	316 SS	316 SS
Enclosure material	Glass filled nylon	Relay ABS	Aluminum Die Cast Explosion Proof
Max pressure	4408 PSI (300 Bar)	4408 PSI (300 Bar)	4408 PSI (300 Bar)
Class Protection	IP 65	IP 65	Eex II B,C

Fault	Cause	Solution
Does not switch	No LED, no power LED doesn't change the state	Check power supply Check the installation (insertion length). Verify the calibration

WARRANTY/DISCLAIMER

OMEGA ENGINEERING, INC. warrants this unit to be free of defects in materials and workmanship for a period of **13 months** from date of purchase. OMEGA's Warranty adds an additional one (1) month grace period to the normal **one (1) year product warranty** to cover handling and shipping time. This ensures that OMEGA's customers receive maximum coverage on each product.

If the unit malfunctions, it must be returned to the factory for evaluation. OMEGA's Customer Service Department will issue an Authorized Return (AR) number immediately upon phone or written request. Upon examination by OMEGA, if the unit is found to be defective, it will be repaired or replaced at no charge. OMEGA's WARRANTY does not apply to defects resulting from any action of the purchaser, including but not limited to mishandling, improper interfacing, operation outside of design limits, improper repair, or unauthorized modification. This WARRANTY is VOID if the unit shows evidence of having been tampered with or shows evidence of having been damaged as a result of excessive corrosion; or current, heat, moisture or vibration; improper specification; misapplication; misuse or other operating conditions outside of OMEGA's control. Components which wear are not warranted, including but not limited to contact points, fuses, and triacs.

OMEGA is pleased to offer suggestions on the use of its various products. However, OMEGA neither assumes responsibility for any omissions or errors nor assumes liability for any damages that result from the use of its products in accordance with information provided by OMEGA, either verbal or written. OMEGA warrants only that the parts manufactured by it will be as specified and free of defects. OMEGA MAKES NO OTHER WARRANTIES OR REPRESENTATIONS OF ANY KIND WHATSOEVER, EXPRESS OR IMPLIED, EXCEPT THAT OF TITLE, AND ALL IMPLIED WARRANTIES INCLUDING ANY WARRANTY OF MERCHANTABILITY AND FITNESS FOR A PARTICULAR PURPOSE ARE HEREBY DISCLAIMED. LIMITATION OF LIABILITY: The remedies of purchaser set forth herein are exclusive, and the total liability of OMEGA with respect to this order, whether based on contract, warranty, negligence, indemnification, strict liability or otherwise, shall not exceed the purchase price of the component upon which liability is based. In no event shall OMEGA be liable for consequential, incidental or special damages.

CONDITIONS: Equipment sold by OMEGA is not intended to be used, nor shall it be used: (1) as a "Basic Component" under 10 CFR 21 (NRC), used in or with any nuclear installation or activity; or (2) in medical applications or used on humans. Should any Product(s) be used in or with any nuclear installation or activity, medical application, used on humans, or misused in any way, OMEGA assumes no responsibility as set forth in our basic WARRANTY/DISCLAIMER language, and, additionally, purchaser will indemnify OMEGA and hold OMEGA harmless from any liability or damage whatsoever arising out of the use of the Product(s) in such a manner.

RETURN REQUESTS/INQUIRIES

Direct all warranty and repair requests/inquiries to the OMEGA Customer Service Department. **BEFORE RETURNING ANY PRODUCT(S) TO OMEGA, PURCHASER MUST OBTAIN AN AUTHORIZED RETURN (AR) NUMBER FROM OMEGA'S CUSTOMER SERVICE DEPARTMENT (IN ORDER TO AVOID PROCESSING DELAYS).** The assigned AR number should then be marked on the outside of the return package and on any correspondence.

The purchaser is responsible for shipping charges, freight, insurance and proper packaging to prevent breakage in transit.

FOR **WARRANTY** RETURNS, please have the following information available BEFORE contacting OMEGA:

1. Purchase Order number under which the product was PURCHASED,
2. Model and serial number of the product under warranty, and
3. Repair instructions and/or specific problems relative to the product.

FOR **NON-WARRANTY** REPAIRS, consult OMEGA for current repair charges. Have the following information available BEFORE contacting OMEGA:

1. Purchase Order number to cover the COST of the repair,
2. Model and serial number of the product, and
3. Repair instructions and/or specific problems relative to the product.

OMEGA's policy is to make running changes, not model changes, whenever an improvement is possible. This affords our customers the latest in technology and engineering.

OMEGA is a registered trademark of OMEGA ENGINEERING, INC.

© Copyright 2003 OMEGA ENGINEERING, INC. All rights reserved. This document may not be copied, photocopied, reproduced, translated, or reduced to any electronic medium or machine-readable form, in whole or in part, without the prior written consent of OMEGA ENGINEERING, INC.

Where Do I Find Everything I Need for Process Measurement and Control? **OMEGA...Of Course!**

Shop online at www.omega.com

TEMPERATURE

- Thermocouple, RTD & Thermistor Probes, Connectors, Panels & Assemblies
- Wire: Thermocouple, RTD & Thermistor
- Calibrators & Ice Point References
- Recorders, Controllers & Process Monitors
- Infrared Pyrometers

PRESSURE, STRAIN AND FORCE

- Transducers & Strain Gages
- Load Cells & Pressure Gages
- Displacement Transducers
- Instrumentation & Accessories

FLOW/LEVEL

- Rotameters, Gas Mass Flowmeters & Flow Computers
- Air Velocity Indicators
- Turbine/Paddlewheel Systems
- Totalizers & Batch Controllers

pH/CONDUCTIVITY

- pH Electrodes, Testers & Accessories
- Benchtop/Laboratory Meters
- Controllers, Calibrators, Simulators & Pumps
- Industrial pH & Conductivity Equipment

DATA ACQUISITION

- Data Acquisition & Engineering Software
- Communications-Based Acquisition Systems
- Plug-in Cards for Apple, IBM & Compatibles
- Datalogging Systems
- Recorders, Printers & Plotters

HEATERS

- Heating Cable
- Cartridge & Strip Heaters
- Immersion & Band Heaters
- Flexible Heaters
- Laboratory Heaters

ENVIRONMENTAL MONITORING AND CONTROL

- Metering & Control Instrumentation
- Refractometers
- Pumps & Tubing
- Air, Soil & Water Monitors
- Industrial Water & Wastewater Treatment
- pH, Conductivity & Dissolved Oxygen Instruments

M3992/0803