

3 YEAR
WARRANTY

OMEGA CARE
Extended Warranty
Program

CE

SA

RU



CN9600 SERIES Autotune Temperature Controllers

User's Guide

Shop online at

omega.com[®]

Ω OMEGA[®]

www.omega.com

e-mail: info@omega.com

Where Do I Find Everything I Need for Process Measurement and Control? OMEGA...Of Course!

Shop online at www.omega.com

TEMPERATURE

- ☑ Thermocouple, RTD & Thermistor Probes, Connectors, Panels & Assemblies
- ☑ Wire: Thermocouple, RTD & Thermistor
- ☑ Calibrators & Ice Point References
- ☑ Recorders, Controllers & Process Monitors
- ☑ Infrared Pyrometers

PRESSURE, STRAIN AND FORCE

- ☑ Transducers & Strain Gages
- ☑ Load Cells & Pressure Gages
- ☑ Displacement Transducers
- ☑ Instrumentation & Accessories

FLOW/LEVEL

- ☑ Rotameters, Gas Mass Flowmeters & Flow Computers
- ☑ Air Velocity Indicators
- ☑ Turbine/Paddlewheel Systems
- ☑ Totalizers & Batch Controllers

pH/CONDUCTIVITY

- ☑ pH Electrodes, Testers & Accessories
- ☑ Benchtop/Laboratory Meters
- ☑ Controllers, Calibrators, Simulators & Pumps
- ☑ Industrial pH & Conductivity Equipment

DATA ACQUISITION

- ☑ Data Acquisition & Engineering Software
- ☑ Communications-Based Acquisition Systems
- ☑ Plug-in Cards for Apple, IBM & Compatibles
- ☑ Datalogging Systems
- ☑ Recorders, Printers & Plotters

HEATERS

- ☑ Heating Cable
- ☑ Cartridge & Strip Heaters
- ☑ Immersion & Band Heaters
- ☑ Flexible Heaters
- ☑ Laboratory Heaters

ENVIRONMENTAL MONITORING AND CONTROL

- ☑ Metering & Control Instrumentation
- ☑ Refractometers
- ☑ Pumps & Tubing
- ☑ Air, Soil & Water Monitors
- ☑ Industrial Water & Wastewater Treatment
- ☑ pH, Conductivity & Dissolved Oxygen Instruments



OMEGAnet® On-Line Service
www.omega.com

Internet e-mail
info@omega.com

Servicing North America:

USA: ISO 9001 Certified
One Omega Drive, Box 4047
Stamford CT 06907-0047
Tel: (203) 359-1660
FAX: (203) 359-7700
e-mail: info@omega.com

Canada:
976 Bergar
Laval (Quebec) H7L 5A1
Tel: (514) 856-6928
FAX: (514) 856-6886
e-mail: info@omega.ca

For immediate technical or application assistance:

USA and Canada:

Sales Service: 1-800-826-6342 / 1-800-TC-OMEGA®
Customer Service: 1-800-622-2378 / 1-800-622-BEST®
Engineering Service: 1-800-872-9436 / 1-800-USA-WHEN®
TELEX: 996404 EASYLINK: 62968934
CABLE: OMEGA

Mexico:

En Español: (001) 203-359-7803
FAX: (001) 203-359-7807
e-mail: espanol@omega.com
info@omega.com.mx

Servicing Europe:

Benelux:

Postbus 8034, 1180 LA Amstelveen
The Netherlands
Tel: +31 (0)20 3472121 FAX: +31 (0)20 6434643
Toll Free in Benelux: 0800 0993344
e-mail: sales@omegaeng.nl

Germany/Austria:

Daimlerstrasse 26, D-75392
Deckenpfronn, Germany
Tel: +49 (0)7056 9398-0 FAX: +49 (0)7056 9398-29
Toll Free in Germany: 0800 639 7678
e-mail: info@omega.dl

Czech Republic:

Rudé armády 1868, 733 01 Karvina 8
Tel: +420 (0)69 6311899 FAX: +420 (0)69 6311114
Toll Free: 0800-1-66342 e-mail: czech@omega.com

United Kingdom: ISO 9002 Certified

One Omega Drive
River Bend Technology Centre
Northbank, Irlam
Manchester M44 5BD United Kingdom
Tel: +44 (0)161 777 6611 FAX: +44 (0)161 777 6622
Toll Free in United Kingdom: 0800-488-488
e-mail: sales@omega.co.uk

France:

9, rue Denis Papin, 78190 Trappes
Tel: +33 (0)130 621 400 FAX: +33 (0)130 699 120
Toll Free in France: 0800-4-06342
e-mail: sales@omega.fr

The CN9 Series Controllers



CN9-SW Software



CN9600 Series



CN9300 Series



CN9400 Series



CN9500 Series

INDEX

INSTRUMENT PANEL FEATURES	2
FUNCTIONS MENU	3
GETTING STARTED	4
Initial Set-up	4
AUTOTUNE	4
Tune or tune at setpoint program	5
PROPORTIONAL CYCLE-TIME	5
Cycle-time recommendations	5
SECOND AND THIRD SETPOINTS (SP2 and SP3)	5
Error messages	6
LINEAR INPUT	6
Set-up procedure	6
FUNCTION LIST	7
Level 1	7
Level 2	7
Level 3	8
Output Options Table	8
Re-transmission	8
Level 4	9
Level A	10
PROGRAMMER	11
Function overview	11
Getting started (Programmer)	12
Program run mode	12
Display functions	12
Example program	13
Function map	14
Function list	16
Memory allocation table	17
Memory full indicator	17
Programming example	18
Program edit example	18
MECHANICAL INSTALLATION	19
DIN panel cut-out	19
Mounting	19
Cleaning	19
ELECTRICAL INSTALLATION	19
Typical application	20
SAFETY AND WARRANTY	20
Input options (diagrams)	21
Output options (diagrams)	21
INPUT SENSOR SELECTION	22
Temperature sensors	22
Linear input	22
SPECIFICATION	22
APPENDIX 1	23
NOTES	24
WARRANTY / DISCLAIMER	25

INSTRUMENT PANEL FEATURES

! This page can be photocopied and used as a visual aid and bookmark when working in other parts of the manual.



ADJUSTMENTS

- | | |
|--|------------------------------------|
| To enter or exit program mode: | Press ▲ ▼ together for 3 seconds |
| To scroll through functions: | Press ▲ or ▼ |
| To change levels or options: | Press ★ ▲ together or ★ ▼ together |
| To view setpoint units: | Press ★ |
| To increase setpoint: | Press ★ ▲ together |
| To decrease setpoint: | Press ★ ▼ together |
| To reset latched alarm or tune fail: | Press ▲ ▼ together briefly |
| To run or Hold a program: | Press ★ ▼ together for 3 seconds |

Notes: If in difficulty by becoming "lost" in program mode, press ▲ and ▼ together for 3 seconds to return to display mode, check the INSTRUMENT ADJUSTMENTS above and try again.

When in program mode, after 60 seconds of key inactivity the display will revert to either *inPt : nonE* or, if the initial configuration has been completed, the measured value. Any settings already completed will be retained. During Program Configuration it is recommended that this feature is inhibited. Select **ProG StAY** in Level 4.

FUNCTIONS MENU

! This page can be photocopied and used as a visual aid and bookmark when working in other parts of the manual.

KEY ★ OR ▲ TOGETHER TO CHANGE LEVELS OR OPTIONS

LEUL4	Derivative sensitivity 0.1 to 1.0 x dE1 (0.5)	Display averaging dir: 1 to 32 ()	Disable AL-alarm display: on	Disable program auto-ent Auto: S1A1	Security lock none; LEV 3; LEV 2; ALL	Change program entry point Off: on	
USER-PROTECTED SETTINGS							
LEUL3	SP1 output device none; rly; S5d; AntG	SP2 output device none; S5d; rly; (read only)	Sensor burn-out uPSC; on; SC; 1u; 2d; 1d; 2u	Reverse outputs 1r; 2d	Reverse OP LEDs 1d; 2d; 1r; 2r; 1d; 2r	SPair adjustment 0.0 to 25%; sensor full scale	
CONFIGURE OUTPUT		SAFETY SETTINGS		CALIBRATION		PERFORMANCE DATA	
LEUL2	Read SP1 output % 0 to 100%; read only	SP1 manual output % 0 to 100%; proportional mode only	Limit SP1 output % 100 to 0%	Limit SP2 output % 100 to 0%	Main SP2 mode none; dVLo; bAnd F; S; H; F; S; Lo; Cool; Exp	Second SP2 mode none; L; C; H; hold; L; L; ho; n; L; n	
MANUAL ADJUSTMENTS			SP2 MODES		RANGING		
LEUL1	Autotune or Park Off; on; Park; Al; Sp	SP1 Prop band (gain) Hyst; 0.1 deg to 100%	Integral time (reset) Off; 0.1 to 60 min (5 min)	Derivative time (rate) Off; 1 to 200 sec (25 sec)	Derivative approach 0.5 to 5.1 x band (1.5)	Cycle time or on/off On; off; 0.1 to 81 sec (20 sec)	
SP1 SETTINGS			SP2 SETTINGS				
LEULP	Program number 1 to 31	Run program Off; on; hold; dBL ins; Copr; P; SE	Power failure recovery mode SE; Cont; hold	Program start value P; V; Sp	Setpoint ramp time units hour; 60s	segment number 1 to 126 max.	
PROGRAMMER SETTINGS							
LEULC	Instrument address 0 to 255	Baud rate 1200; 2400; 4800 9600	Data format 18n1; 18E1; 1801	Trkx activity Off; on	Soak time interval Cont; 0.1 to 1400 (10) min	Program re-cycle count Cont; 1 to 999	
COMMS SETTINGS				SP3 SETTINGS			
LEULA	High scale 1000 -1999 to 9999	Low scale 0 -1999 to 9999	Input high 50.0 0.0 to 50.0	Input low 10.0 0.0 to 49.9	Decimal 0000 000.0 or 00.00	Main mode none dVLo; bAnd; F; S; H; F; S; Lo; Exp	
LINEAR SCALING AND INPUT SETTINGS				SP3 MODES		SP3 ADJUSTMENTS	
LEUL3	SP1 output device none; rly; S5d; AntG	SP2 output device none; S5d; rly; (read only)	Sensor burn-out uPSC; on; SC; 1u; 2d; 1d; 2u	Reverse outputs 1r; 2d	Reverse OP LEDs 1d; 2d; 1r; 2r; 1d; 2r	SPair adjustment 0.0 to 25%; sensor full scale	
CONFIGURE OUTPUT		SAFETY SETTINGS		CALIBRATION		PERFORMANCE DATA	
LEUL2	Read SP1 output % 0 to 100%; read only	SP1 manual output % 0 to 100%; proportional mode only	Limit SP1 output % 100 to 0%	Limit SP2 output % 100 to 0%	Main SP2 mode none; dVLo; bAnd F; S; H; F; S; Lo; Cool; Exp	Second SP2 mode none; L; C; H; hold; L; L; ho; n; L; n	
MANUAL ADJUSTMENTS			SP2 MODES		RANGING		
LEUL1	Autotune or Park Off; on; Park; Al; Sp	SP1 Prop band (gain) Hyst; 0.1 deg to 100%	Integral time (reset) Off; 0.1 to 60 min (5 min)	Derivative time (rate) Off; 1 to 200 sec (25 sec)	Derivative approach 0.5 to 5.1 x band (1.5)	Cycle time or on/off On; off; 0.1 to 81 sec (20 sec)	
SP1 SETTINGS			SP2 SETTINGS				
LEULP	Program number 1 to 31	Run program Off; on; hold; dBL ins; Copr; P; SE	Power failure recovery mode SE; Cont; hold	Program start value P; V; Sp	Setpoint ramp time units hour; 60s	segment number 1 to 126 max.	
PROGRAMMER SETTINGS							
LEULC	Instrument address 0 to 255	Baud rate 1200; 2400; 4800 9600	Data format 18n1; 18E1; 1801	Trkx activity Off; on	Soak time interval Cont; 0.1 to 1400 (10) min	Program re-cycle count Cont; 1 to 999	
COMMS SETTINGS				SP3 SETTINGS			
LEULA	High scale 1000 -1999 to 9999	Low scale 0 -1999 to 9999	Input high 50.0 0.0 to 50.0	Input low 10.0 0.0 to 49.9	Decimal 0000 000.0 or 00.00	Main mode none dVLo; bAnd; F; S; H; F; S; Lo; Exp	
LINEAR SCALING AND INPUT SETTINGS				SP3 MODES		SP3 ADJUSTMENTS	
LEUL3	SP1 output device none; rly; S5d; AntG	SP2 output device none; S5d; rly; (read only)	Sensor burn-out uPSC; on; SC; 1u; 2d; 1d; 2u	Reverse outputs 1r; 2d	Reverse OP LEDs 1d; 2d; 1r; 2r; 1d; 2r	SPair adjustment 0.0 to 25%; sensor full scale	
CONFIGURE OUTPUT		SAFETY SETTINGS		CALIBRATION		PERFORMANCE DATA	
LEUL2	Read SP1 output % 0 to 100%; read only	SP1 manual output % 0 to 100%; proportional mode only	Limit SP1 output % 100 to 0%	Limit SP2 output % 100 to 0%	Main SP2 mode none; dVLo; bAnd F; S; H; F; S; Lo; Cool; Exp	Second SP2 mode none; L; C; H; hold; L; L; ho; n; L; n	
MANUAL ADJUSTMENTS			SP2 MODES		RANGING		
LEUL1	Autotune or Park Off; on; Park; Al; Sp	SP1 Prop band (gain) Hyst; 0.1 deg to 100%	Integral time (reset) Off; 0.1 to 60 min (5 min)	Derivative time (rate) Off; 1 to 200 sec (25 sec)	Derivative approach 0.5 to 5.1 x band (1.5)	Cycle time or on/off On; off; 0.1 to 81 sec (20 sec)	
SP1 SETTINGS			SP2 SETTINGS				
LEULP	Program number 1 to 31	Run program Off; on; hold; dBL ins; Copr; P; SE	Power failure recovery mode SE; Cont; hold	Program start value P; V; Sp	Setpoint ramp time units hour; 60s	segment number 1 to 126 max.	
PROGRAMMER SETTINGS							
LEULC	Instrument address 0 to 255	Baud rate 1200; 2400; 4800 9600	Data format 18n1; 18E1; 1801	Trkx activity Off; on	Soak time interval Cont; 0.1 to 1400 (10) min	Program re-cycle count Cont; 1 to 999	
COMMS SETTINGS				SP3 SETTINGS			
LEULA	High scale 1000 -1999 to 9999	Low scale 0 -1999 to 9999	Input high 50.0 0.0 to 50.0	Input low 10.0 0.0 to 49.9	Decimal 0000 000.0 or 00.00	Main mode none dVLo; bAnd; F; S; H; F; S; Lo; Exp	
LINEAR SCALING AND INPUT SETTINGS				SP3 MODES		SP3 ADJUSTMENTS	
LEUL3	SP1 output device none; rly; S5d; AntG	SP2 output device none; S5d; rly; (read only)	Sensor burn-out uPSC; on; SC; 1u; 2d; 1d; 2u	Reverse outputs 1r; 2d	Reverse OP LEDs 1d; 2d; 1r; 2r; 1d; 2r	SPair adjustment 0.0 to 25%; sensor full scale	
CONFIGURE OUTPUT		SAFETY SETTINGS		CALIBRATION		PERFORMANCE DATA	
LEUL2	Read SP1 output % 0 to 100%; read only	SP1 manual output % 0 to 100%; proportional mode only	Limit SP1 output % 100 to 0%	Limit SP2 output % 100 to 0%	Main SP2 mode none; dVLo; bAnd F; S; H; F; S; Lo; Cool; Exp	Second SP2 mode none; L; C; H; hold; L; L; ho; n; L; n	
MANUAL ADJUSTMENTS			SP2 MODES		RANGING		
LEUL1	Autotune or Park Off; on; Park; Al; Sp	SP1 Prop band (gain) Hyst; 0.1 deg to 100%	Integral time (reset) Off; 0.1 to 60 min (5 min)	Derivative time (rate) Off; 1 to 200 sec (25 sec)	Derivative approach 0.5 to 5.1 x band (1.5)	Cycle time or on/off On; off; 0.1 to 81 sec (20 sec)	
SP1 SETTINGS			SP2 SETTINGS				
LEULP	Program number 1 to 31	Run program Off; on; hold; dBL ins; Copr; P; SE	Power failure recovery mode SE; Cont; hold	Program start value P; V; Sp	Setpoint ramp time units hour; 60s	segment number 1 to 126 max.	
PROGRAMMER SETTINGS							
LEULC	Instrument address 0 to 255	Baud rate 1200; 2400; 4800 9600	Data format 18n1; 18E1; 1801	Trkx activity Off; on	Soak time interval Cont; 0.1 to 1400 (10) min	Program re-cycle count Cont; 1 to 999	
COMMS SETTINGS				SP3 SETTINGS			
LEULA	High scale 1000 -1999 to 9999	Low scale 0 -1999 to 9999	Input high 50.0 0.0 to 50.0	Input low 10.0 0.0 to 49.9	Decimal 0000 000.0 or 00.00	Main mode none dVLo; bAnd; F; S; H; F; S; Lo; Exp	
LINEAR SCALING AND INPUT SETTINGS				SP3 MODES		SP3 ADJUSTMENTS	

INITIAL SET-UP ENTRY

Range of Adjustment shown under description.

If applicable, factory settings shown in bold.

For a full description of menu functions refer to pages 7 to 10, and 16/17 in Programmer section.

Note: The letter K appears in the instrument display as the character **K**

KEY ▼ OR ▲ TO VIEW FUNCTIONS

GETTING STARTED

After power-up the controller requires programming with the following information:

Type of Sensor (See list of sensors p.22)

Operating unit °C °F bAr PSI Ph rh SEt

Allocation of Output Device to SP1/SP2 (Relay / SSd) or analog. SP3 is always relay.

Setpoint

When the above information has been programmed into the controller it will be operational with factory PID settings.

INITIAL SET-UP

On power-up the controller will display the self test sequence followed by the initial display **inPt : nonE**

1 Select input sensor.

Press and hold **★** and use the **▲** or **▼** buttons to scroll through the sensor selection list until the correct sensor is displayed. Release the buttons. The display will now read selected sensor type e.g. **inPt : tCS** (type S thermocouple).

Press **▲** once The display will now read **unit : nonE**

LINEAR INPUT

When **Linear Input** is selected, the display resolution of the **setpoint** and many other functions will be changed from the setting previously made at **di.SP** in Level 2, to that set at **dECP** in Level A.

It is therefore recommended that on completion of the **Initial Set-up** the **Linear Input** settings in Level A be completed before moving on to configure Levels 1, 2 and 3. (see Set-up Procedure page 6).

2 Select operating unit.

Press and hold **★** and use the **▲** or **▼** buttons to scroll through the unit selection list until the correct unit is displayed. Release the buttons. The display will read selected unit e.g. **unit : °C**

Press **▲** once The display will now read **SP1.d : nonE**

3 Select SP1 (Main setpoint output device)

Analog output

For optimum control use a proportional cycle time setting of one second. Where the analog output is allocated to **SP2**, the default setting **on/off** must be manually changed in **Level 1** to a **time proportioning** setting to enable the analog output to operate in **proportional control mode**.

Press and hold **★** and use the **▲** or **▼** buttons to select from the choices **Rly**, **SSd** or **AnLG** depending on the model supplied. SP2 and SP3 outputs will be automatically allocated. (See output options table on page 8).

4 To enter initial configuration into controller memory

Press and hold both **▲** and **▼** buttons for 3 seconds. The display will now read **PARk** and measured variable (e.g. ambient temperature 23°). **PARk** is displayed because a setpoint has not yet been entered.

To display setpoint units

Press and hold **★** The displays will now read **unit** (eg. °C) and **0**

To enter setpoint

Press and hold **★** and use **▲** button to increase or **▼** button to decrease the reading and scroll to required setpoint value. (The digit roll-over rate increases with time).

THE CONTROLLER IS NOW OPERATIONAL WITH THE FOLLOWING FACTORY SETTINGS

Proportional band/Gain	10°C/18°F/100 units
Integral time/Reset	5 mins
Derivative time/Rate	25 secs
Proportional cycle-time (Typical setting for relay output)	20 secs
DAC Derivative approach control (Average setting for minimum overshoot)	1.5

Note: For more precise control or for non temperature applications where a **Linear input** transducer is being used, the controller may need to be tuned to the process. Please refer to the following section on AUTOTUNE.

AUTOTUNE

This is a single shot procedure to match the controller to the process. Select either **Tune** or **Tune at Setpoint** from the criteria given below.

The **Tune** program should be used for applications other than those listed under **Tune at Setpoint** below. The procedure will apply disturbances when the temperature or process reaches 75% of the setpoint value, causing overshoot which is monitored in order to adjust the **DAC** overshoot inhibit feature. Care should be taken to ensure that any overshoot is safe for the process.

The **Tune at Setpoint** program is recommended when:

- The process is already at setpoint and control is poor
- The setpoint is less than 100°C in a temperature application
- Re-tuning after a large setpoint change
- Tuning multi-zone and/or heat-cool applications.

Notes: **DAC** is not re-adjusted by **Tune** at setpoint. **Proportional Cycle Time** can be pre-selected before running the Autotune program. (see page 5).

AUTOTUNE (continued)

Hereafter in the Manual the symbol (▲▼) signifies both buttons are held pressed for 3 seconds to ENTER or EXIT Program mode.

TUNE OR TUNE AT SETPOINT PROGRAM

Enter program (▲▼) and from the display *tunE : oFF* press and hold * and press ▲ to display *tunE : on* or *tunE : At.SP* Exit program mode (▲▼).

The TUNE program will now start. The display will show *tunE* as the process variable climbs to setpoint.

Note: Avoid tuning while running a program as SP1 may be different from the target setpoint..

When the TUNE or TUNE AT SETPOINT program is complete the PID values are entered automatically. The process will rise to setpoint and control should be stable. If not, this may be because optimum cycle time is not automatically implemented. To set the cycle time see **PROPORTIONAL CYCLE-TIME**.

PROPORTIONAL CYCLE-TIME

The choice of cycle-time is influenced by the external switching device or load. eg. contactor, SSR, valve. A setting that is too long for the process will cause oscillation and a setting that is too short will cause unnecessary wear to an electro-mechanical switching device.

Factory set

To use the 20 sec factory set cycle-time no action is needed whether autotune is used or not.

To Manually Select AUTOTUNE Calculated CYCLE-TIME

When AUTOTUNE is completed, enter program (▲▼) and select *CYC.t* in Level 1. The display will read *CYC.t : 20* (the factory setting).

To view the new calculated optimum value, press and hold both * and ▼ buttons until indexing stops. The calculated value will be displayed eg. **A16**. If acceptable, exit program (▲▼) to implement this setting.

To Pre-select Automatic Acceptance of AUTOTUNE Calculated CYCLE-TIME

Before AUTOTUNE is initiated select *CYC.t* in Level1, press and hold both * and ▼ buttons until indexing stops at **A--**. Exit program (▲▼) to accept calculated value automatically.

To Manually Pre-select Preferred CYCLE-TIME

Before AUTOTUNE is initiated select *CYC.t* in Level 1, press and hold both * and ▲ or ▼ buttons until indexing stops at preferred value then exit program (▲▼) to accept.

CYCLE-TIME RECOMMENDATIONS

Output Device	Factory Setting	Recommended Minimum
Internal relays	20 seconds	10 seconds
Solid state drives	20 seconds	0.1 seconds

SECOND AND THIRD SETPOINTS (SP2 and SP3)

PRIMARY ALARM MODES

Configure SP2 output to operate as an alarm from **SP2.A** in Level 2 and set the alarm setting in **SEt.2** Level 1.

Configure SP3 alarm mode **SP3.A** and setting **SEt.3** in Level A. The alarms will be individually triggered when the process value changes according to the options listed below.

- dV.hi** Rises above the main setpoint by the value inserted at **SEt.2/3**.
- dV.Lo** Falls below the main setpoint by the value inserted at **SEt.2/3**.
- BAnd** Rises above or falls below the main setpoint by the value inserted at **SEt.2/3**.
- FS.hi** Rises above the full scale setting of **SEt.2** or **SEt.3**.
- FS.Lo** Falls below the full scale setting of **SEt.2** or **SEt.3**.
- EoP** Event Output (See **Programmer** section pages 11 to 18)

SUBSIDIARY SP2 / SP3 MODES











The following additional Subsidiary alarm functions can be added to any Primary alarm configurations using the settings found at **SP2.b** in Level 2 and **SP3.b** in Level A.

- LtCh** Once activated, the alarms will latch and can be manually reset when the alarm condition has been removed.
- hOld** This feature inhibits alarm operations on power-up and is automatically disabled once the process reaches the alarm setting.
- Lt.ho** Combines the effects of both **LtCh** and **hOld** and can be applied to any Primary alarm configuration.

SECOND SETPOINT (SP2) Proportional control output

Configure in Level 1 using *CyC.2* to select proportional cycle time and *bnd.2* to adjust proportioning band. For Heat/Cool operation see Operating Manual.

In on-off mode, *bnd.2* adjusts SP2 hysteresis.

Alarm type	On-Off operating mode SP2 and SP3	Proportional operating mode SP2 and SP3	Legend
Deviation dV.hi dV.Lo BAnd	Output state:  LED state: 	Output state:  LED state:  <i>BAnd</i> : on-off mode only	 Output ON (Relay or SSD energised)
Full scale FS.hi FS.Lo	Output state:  LED state: 	Output state:  LED state: 	 Output OFF (Relay or SSD de-energised)
EoP Strategy	Temperature above setpoint		 LED ON

SP2 / SP3 OUTPUT AND LED STATUS IN ALARM CONDITION

SP2 / SP3 ALARM ANNUNCIATOR

If a Primary Alarm mode has been configured, when an alarm condition occurs the alarm annunciator **-AL-** will be displayed alternating with the process variable. The alarm together with the display, will be automatically reset as soon as the alarm condition has been cleared.

The annunciator may be disabled by selecting **no.AL: on**, in Level 4.

ERROR MESSAGES

SENSOR FAULT

Display flashes: **inPt: FAIL**

Indicates: sensor open or short circuit or linear input over-range.

Action: Check sensor/wiring/connectors

NON-VOLATILE MEMORY ERROR

Display flashes: **dAtA: FAIL**

Action: De-power briefly. Replace unit if problem persists

MANUAL POWER ERROR

Display flashes: **hAnd: FAIL**

SP1 set to on-off in **CYC.t**

Action: Select proportional mode

IMMEDIATE FAIL ON AUTOTUNE START

Display flashes: **tunE: FAIL**

Setpoint display 0

1. No setpoint entered.

Action: Enter setpoint

2. SP1 set to ON/OFF in **Cyc.t**

Action: Select proportional mode

Note: To reset and clear error press **▲▼** together briefly to cancel message.

FAIL LATER DURING AUTOTUNE CYCLE

The thermal characteristics of the load exceed the Autotune algorithm limits. The failure point indicated by any display 0.0 in **tech** e.g. **Ctb** = 0.0

Action: 1. Change the conditions. eg. raise setpoint

2. Try **tunE: At.SP**

3. If the error message persists, call Omega for advice.

LINEAR INPUT

Set-up Procedure

The **4–20mA** input model converts current into voltage using an internal resistor which spreads the signal across the input range **10 to 50 mV**. using multiplier of 2.5. When using a transducer with an output less than 4–20mA, the **input maximum and minimum mV** values can be calculated using the same multiplier.

Models with **0 to 5V** input use an internal resistor to spread the signal across the input range **0 to 50 mV** using a divider of 100. Where a transducer provides a smaller output, the **input maximum and minimum** values can be similarly calculated.

Decide what scale **minimum** and **maximum** will be required, and whether the scale needs **inverting**. (See Level A: **Linear Input Scaling** for list of settings and limits, page 10).

The example below shows how a **4–20mA linear Input** should be configured.

e.g. 4–20mA = 60 to 260 units where 4mA = 60 units

Follow **INITIAL SET-UP** procedure (also see page 4).

1. Select input sensor Select **inPt:Lin**
2. Select unit Select required unit, if not available Select **unit:SEt**
3. Select SP1 output Select from: **Rly, SSd** or **AnLG**

Enter initial configuration into controller memory

DO NOT ENTER SETPOINT until **Linear Input** has been configured in **Level A**
See **functions menu** page 3
and **functions list** page 10.

Configure Linear Input Enter level A

(Then using example given # above)

4. Enter scale maximum Select **An.hi:260**
5. Enter scale minimum Select **An.Lo:60**
6. Enter input maximum Select **hi.in:50.0**
7. Enter input minimum Select **Lo.in:10.0**
8. Enter display resolution Select **dECP:0000** (WARNING – otherwise settings marked **↔** may be altered)

Enter Linear Input configuration into controller memory and enter setpoint.

Now configure Levels 1, 2 and 3 and if required proceed with AUTOTUNE.

Note: Any apparent calibration errors can be removed using the **ZERo** and **SPAN** adjustments in **Level 3**.

FUNCTION LIST (LEVELS 1 to 4 and A)

Note: A Functions Menu is shown on page 3.

LEVEL 1 LEVEL 1

Function Options [Factory settings] shown in brackets

SELECT AUTOTUNE (see pages 4/5)

tunE [oFF] on **PARk At.SP**

Used to switch the Autotune feature on and off, to select **PARk** or Autotune at setpoint. **PARk** temporarily turns the output(s) off. To use select **PARk** and exit program mode. To disable re-enter program at **tunE** and select **oFF**.

SP1 OPERATING PARAMETERS

bAnd 0.1 to * C/F [10°C/18°F/100 units]

SP1 proportional band/Gain or Hysteresis

* 100% (**Hi.Sc**) sensor maximum Proportional control eliminates the cycling of on-off control. Output power is reduced, by time proportioning action, across the proportional band.

int.t oFF 0.1 to 60 minutes [5.0]

SP1 integral time/reset

Auto-corrects proportional control offset error

dEr.t oFF 1 - 200 seconds [25]

SP1 derivate time/rate

Suppresses overshoot and speeds response to disturbances

dAC 0.5 - 5.0 x **bAnd** [1.5]

SP1 derivative approach control dAC

Tunes warm-up characteristics, independent of normal operating conditions, by adjusting when derivative action starts during start-up (smaller dAC value = nearer setpoint).

CyC.t A -- on.oF 0.1 - 81 sec [20]

SP1 proportional cycle-time (see pages 9/10)

Determines the cycle rate of the output device for proportional control. Select **on.oF** for ON/OFF mode.

oFSt 0 to * °C/°F/units [0]

SP1 offset/manual reset

* ±50% **bAnd**. Applicable in proportional and ON/OFF mode with integral disable:

int.t : oFF.

SPLK [oFF] on

Lock main setpoint

Locks the setpoint preventing unauthorised adjustment.

SP2 OPERATING PARAMETERS (see page 6)

Function Options [Factory settings] shown in brackets

SEt.2 [0] to * °C/°F/units

Adjust SP2 setpoint

* Deviation Alarms **DV.hi**, **DV.Lo**, **bAnd** 25% sensor maximum.

* Full scale alarms **FS.hi**, **FS.Lo** sensor range f/s

bnd.2 0.1 - * °C/°F/units [2.0 °C/3.6°F 2 units]

Adjust SP2 hysteresis or proportional band/gain

(see **CyC.2** setting)

* 100% sensor f/s (**Hi.Sc**)

CyC.2 [on.oFF] 0.1-81 seconds

Select SP2 ON/OFF or proportional cycle-time

Select on.oFF for ON/OFF mode, or the cycle rate of SP2 output device for proportional mode.

LEVEL 2 LEVEL 2

MANUAL CONTROL MODES

Function Options [Factory settings] shown in brackets

SPI.P 0 to 100 % 'read only'

Read SP1 output percentage power

hAnd [oFF] 1 to 100 % (not in ON/OFF)

SP1 manual percentage power control

For manual control should a sensor fail. Record typical **SPI.P** values beforehand.

PL.1 100 to 0 % duty cycle [100]

Set SP1 power limit percentage

Limits maximum SP1 heating power during start-up and in proportional band.

PL.2 100 to 0 % duty cycle [100]

Set SP2 percentage power limit (cooling)

SP2 OPERATING MODES (see page 5)

SP2.A [nonE] **dV.hi** **dV.Lo** **bAnd** **FS.hi** **FS.Lo** **Cool** **EoP**

Main SP2 operating mode

SP2.b [nonE] **LtCh** **hoLd** **nLin**

Subsidiary SP2 mode: latch/sequence

Non-linear cool proportional band

Will be affected by dECP settings in Level A

LEVEL 3 CONTINUED

Function	Options	<i>[Factory settings] shown in brackets</i>	
----------	---------	---	--

rEu.d Select output modes: Direct/Reverse

Caution: Settings affect fail safe state.

	SP1	SP2
<i>[1r.2d]</i>	Reverse	Direct
<i>1d.2d</i>	Direct	Direct
<i>1r.2r</i>	Reverse	Reverse
<i>1d.2r</i>	Direct	Reverse

Select **Reverse** on SP1 for heating and **Direct** for cooling applications.**rEu.L** Select SP1/2 LED indicator modes

	SP1	SP2
<i>[1n.2n]</i>	Normal	Normal
<i>1i.2n</i>	Invert	Normal
<i>1n.2i</i>	Normal	Invert
<i>1i.2i</i>	Invert	Invert

✚ SPAn <i>[0.0]</i>	to ±25% sensor maximum	<i>-1999–2500 in Linear</i>
----------------------------	-------------------------------	-----------------------------

Sensor span adjust
For recalibrating to align readings with another instrument e.g. External Meter, data logger.

✚ ZEr0 <i>[0.0]</i>	to ±25% sensor f/s	<i>-1999–2500 in Linear</i>
----------------------------	---------------------------	-----------------------------

Zero sensor error (see Sensor span adjust above).

ChEK <i>[oFF]</i>	on
--------------------------	-----------

Select control accuracy monitor

✚ rEAD <i>[Var]</i>	hi Lo
----------------------------	--------------

Read control accuracy monitor

✚ tECh <i>[Ct A]</i>	CT b Ct 1 Ct 2 Ct 3 Ct 4 oS 1 uS oS 2
-----------------------------	--

Read Autotune tuning cycle data

UEr Software version number**rSET** *[nonE]* **ALL**

Resets all functions to factory settings

Caution: This selection will lose all of the current settings.

LEVEL 4 LEVEL 4Access to level 4 is gained through **UEr** in level 3. Press and hold ▲ and ▼ for 10 seconds.Enter level 4 at **LoCk**, release ▲ and ▼ together. Display reads **LoCk nonE****Program security using LoCk** *[nonE]*Select from three **LoCk** options: Press and hold ✱, press ▲ to index.**LEV.3** locks level 3, 4, A, P (and C when fitted)**LEV.2** locks level 2, 3, 4, A, P (and C when fitted)**ALL** locks all functions (including C when fitted)**Note:** Any locked functions and options can still be read.

Press ▼ to access following functions.

Function	Options	<i>[Factory settings] shown in brackets</i>
----------	---------	---

ProG *[Auto]* **StAY**

Program mode auto-exit switch

Auto-exit returns display to normal if 60 seconds of key inactivity, select **StAY** to disable**no.AL** *[oFF]* **on**

Disable SP2 alarm annunciator -AL-

Select on to disable -AL-

di.SS dir **1 to 32** *[6]*

Display sensitivity

dir = direct display of input **1** = maximum, **32** = minimum sensitivity**dEr.S** **0.1 to 1.0** *[0.5]*

Derivative sensitivity

SEt.L <i>(oFF)</i>	on	Remember next menu exit point and use as new menu entry point, except when exit is in Level 1.
---------------------------	-----------	--

LEVEL P LEVEL P

See PROGRAMMER Section, page 11.

LEVEL C LEVEL C

COMMS SETTINGS; visible only when Comms option fitted.

LEVEL A LEVEL A

Function	Options	<i>[Factory settings] shown in brackets</i>
brn.3 [uPSC] Sensor burn-out / break protection Select upscale or downscale	uPSC or dnSC	
rEV.3 [3d] Reverse SP3 output mode Select direct or reverse operation	3d or 3r	

Function Options *[Factory settings] shown in brackets*

Linear Input Scaling

Please read in conjunction with Linear Input Set-up Procedure on page 6.

⚙️ **An.hi** **-1999 to 9999** *[1000]*
Adjusts required scale maximum

⚙️ **An.Lo** **-1999 to 9999** *[0]*
Adjusts required scale minimum

hi.in **0.1 to 50.0** *[50.0]*
Configure input maximum

Lo.in **0.0 to 49.9** *[10.0]*
Configure Input minimum
This setting must be at least 0.1 less than the setting for **hi.in** above.

Note: Refer to Linear Input conversion factors detailed in the Set-up Procedure on page 6.

dECP **000.0 to 00.00** *[0000]*
Scale resolution

NB: Once the **Linear Input** option has been selected, the setting here over-rides the scale resolution setting **di.SP** in Level 2 and will affect the following display readings:

- Level A: **An.hi; An.Lo; Set.3; hYS.3**
- Level 1: **bAnd; ofSt; SPrr; SEt2; bnd.2**
- Level 2: **hiSC; LoSC**
- Level 3: **SPAn; ZERo; rEAd; tECh**

SP3 SETTINGS

SP3.A *[nonE]* **dV.hi dV.lo bAnd FS.hi FS.Lo EoP**
Main SP3 operating mode

SP3.b *[nonE]* **LtCh hoLd Lt.ho**
Subsidiary SP3 operating mode

SEt.3 **0 to 2500** *[0]*
SP3 setpoint adjustment

hyS.3 **0.1 to 100% of hiSC** *[20]*
Set SP3 hysteresis

PROGRAMMER

INDEX

Function overview	11
Getting started	12
Program run mode	12
Display functions	12
Example program	13
Function map	14
Function list	16
Memory allocation table	17
Memory full indicator	17
Programming example	18
Program edit example	18

FUNCTION OVERVIEW

The Programmer function in Level P enables the Model CN9600 to control applications needing **Setpoint** changes over time. Examples of this are **Ramp** changes where a gradual **Rate** of change can be set, or **Step** changes which are instantaneous. These can be separated by **Soak** periods during which the process is held at a constant value. Each individual time interval of the program or **Segment**, together with its associated moving setpoint value can be stored as a unique **Program** and for example be represented by the diagram below.

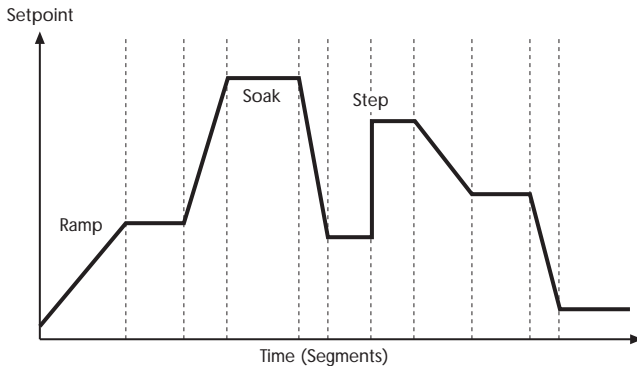

In addition to those settings that determine the segment profile, it is also necessary to set **program start** values, together with the preferred **ramp rate time units** for each individual program.

At the end of a sequence, a Program can be arranged to repeat (**Loop**), either a specified number of **Cycles**, or continuously. Only one **Loop** can be included in a **Program**. When the program is running, the **Display** indicates progress through the sequence of segments, and can additionally be interrogated for further segment information.

It is also possible to **CALL** an already existing program as a sub program that can be inserted as a segment of another program.

To speed up **Program** configuration, several **Edit** functions have been provided so that individual **Segments** and **Programs** may be **Deleted** or **Inserted**, and an entire **Program** may be **Copied** and then **Pasted** into another that it will replace.

For safety reasons, three modes of recovery from a power failure are available. These either automatically **Re-start** the Program from the beginning, **Continue** it from where it stopped, or **Hold** it waiting for a user re-start.

Either one or both of the two auxiliary outputs can be configured as **Event** outputs. Engaging the **Holdback** feature will temporarily halt Setpoint ramping to allow the process temperature to catch up should it deviate by more than a pre-set amount during a **Ramp** segment.

To afford maximum programming flexibility, memory is allocated dynamically, and not pre-allocated. This allows the user the freedom to configure a small number of long programs or a larger number of shorter ones, up to the permitted maximum of 126 Segments per program, and a limit of 31 Programs. Should these limits be exceeded, or the Programmer memory become fully used, the display will read **ProG FULL**. Programs can be planned using the **Memory Allocation Table** which details the memory requirements of individual segment types. During configuration a check can be kept on memory usage by interrogating the **USED** feature of the display to give an instant reading of 'percentage memory used'.

Finally, once a program has been configured, it can be run from the **run off/on/hold** controls in Level P, and in addition a quick access **run/hold** toggle is directly available from the front panel.

The Programmer **Functions List** describes the full range of available **Settings** for each **Programmer Function** together with their display mnemonic. The **Model CN9600** is supplied with a suite of **Factory Settings** for each **Function**. These are shown in bold type.

The Functions Map illustrates the relationship between the **Functions** and their **Settings** and provides a guide to the **Keying Operations** required to navigate around the menu when configuring or running a Program.

GETTING STARTED (PROGRAMMER)

For users with previous experience of configuring programmers, the **Function List** and **Functions Map** on pages 14/15 and 16/17 respectively will be reasonably self explanatory. The Functions and their Settings are grouped to maximise speed of Programming.

New users should take a short time to study the following before starting to configure the first program, and may wish to take on board the following tips and suggestions.

Program Mode Exit switch (*ProG/Auto*) Program Level 4.

This standard feature of the Model CN9600 causes automatic exit from program mode after sixty seconds of Key inactivity. It is highly recommended that this setting be disabled and changed to *ProG/StAy* to ensure that adequate time is available for making unfamiliar adjustments. (see page 9). It may also be useful at this point to consider the setting also on Level 4, *SEt.L* that enable the Programmer menu entry point to be changed from it's default position to the point of last exit. (see page 9).

Program Parameter List

Listing the required **Program Settings** and **Parameter Values** segment by segment beside each **Setting/Segment Number**, and **Program Display Mnemonic** will reduce the risk of programming mistakes during the learning period.

Memorise Basic Key Functions

Use the Function Map on pages 14 and 15 to become familiar with the following Menu Navigation principles.

Hold both ▲ and ▼ for three seconds to enter or exit Program Mode.

Key either ▲ or ▼ to view Functions (follow horizontal arrows).

Key either ★▲ or ★▼ to view or change settings (follow vertical arrows).

Key ★ and hold for three seconds to confirm Edit Functions. †

Note: **Factory Settings** appear in the lower display in each of the **Functions** illustrated in the **Function Map**.

Program configuration

When the PROGRAMMER function is entered at **LEVL P**, the Programmer is automatically presented in Configuration Mode, and the instrument display can be used to access and adjust the various **FUNCTIONS** as they appear in the **FUNCTIONS MAP** illustrated on pages 14 and 15.

Program Run Mode

To run a Program from **LEVL P**,

Press ▲ once, then use ★▲ to select the required program number from the *ProG* list.

Press ▲ again once then use ★▲ to select the run/on option.

Press ▼▲ and hold for three seconds to exit configuration mode and run the program.

Run/Hold Toggle Feature

Press ★▼ and hold for 3 seconds to **hold** the program.

Press ★▼ again and hold for 3 seconds to **run** the program.

Note: Level P is 'read only' while a program is active.

To run a stopped program again press and hold the ★▼ to toggle RUN ON/OFF/ON again.

DISPLAY FUNCTIONS

Once the program is running, the display automatically tracks the progress of the program as it indexes through it's sequence of segments. When it concludes it's final instruction, the upper display alternates *StoP* with the **Process Value** and the lower display reverts to the instrument **SP1 Setpoint**.

RAMP

The upper display alternates between *SPr* and the moving **Process Value** while the lower display shows **Target Setpoint**. If **Holdback** is activated, the decimal point in the lower right corner of the upper display will be illuminated.

SOAK

The upper display alternates between *SoAK* and the **Process Value**. The lower display reads the **Target Setpoint** of the current segment.

STEP (not displayed)

As this involves an instantaneous change of the **Target Setpoint**, this segment occupies zero time and the program immediately moves to the next segment. The lower display then registers the new **Target Setpoint**, with the upper display alternating in either *SPr* or *SoAK* mode according to the segment configuration.

HOLD

If the program is paused in **HOLD**, the upper display alternates between *hoLd* and the **Process Value**, while the lower display indicates the **Target Setpoint** of the current segment.

User Displays

With the program running, a further display function is available at any time.

Press and hold ★

Display shows Program Number

Also press ▲ once

Display shows Segment Number

Press ▲ again

Display shows number of loops completed if a loop function has been set.

Press ▲ again

Upper display reads *t.SP*

Lower display shows moving **Ramp** setpoint

Or if in Soak Segment

Upper display reads *Sint* (Soak interval)

Lower display reads remaining **Soak** time

Release ★

To return display to Program Run mode

EXAMPLE PROGRAM

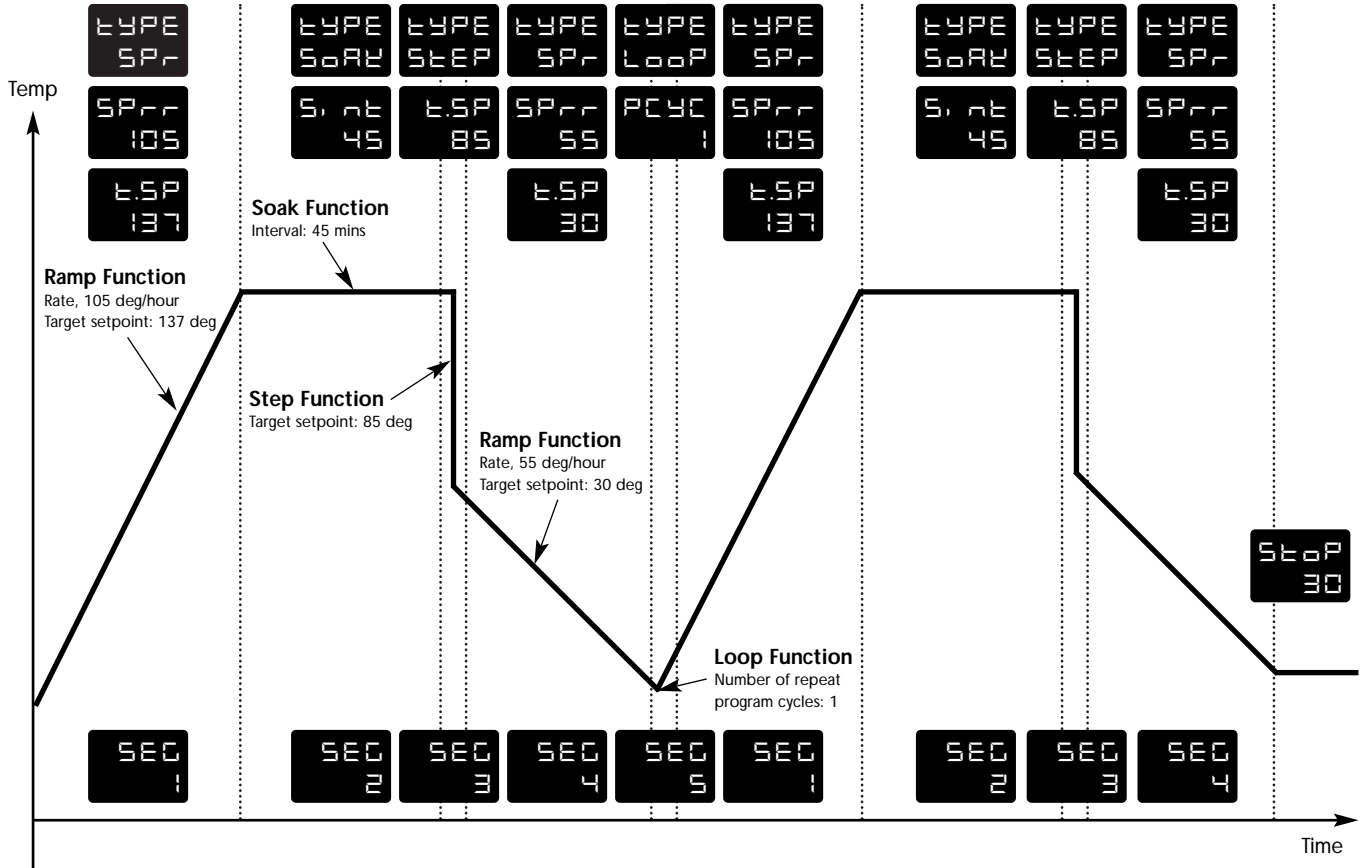

TYPE
SP1
SP1
105
ESP
137

TYPE SOAK STEP SP1 LOOP SP1
S,nt 45 t.SP 85 SP1 55 PCYC 1 SP1 105
ESP 30 ESP 137

TYPE SOAK STEP SP1
S,nt 45 t.SP 85 SP1 55
ESP 30

SEC
1

SEC 2 SEC 3 SEC 4 SEC 5 SEC 1

SEC 2 SEC 3 SEC 4

PROC
3

See segment configuration of this program detailed on page 18.

PROGRAMMER FUNCTION MAP

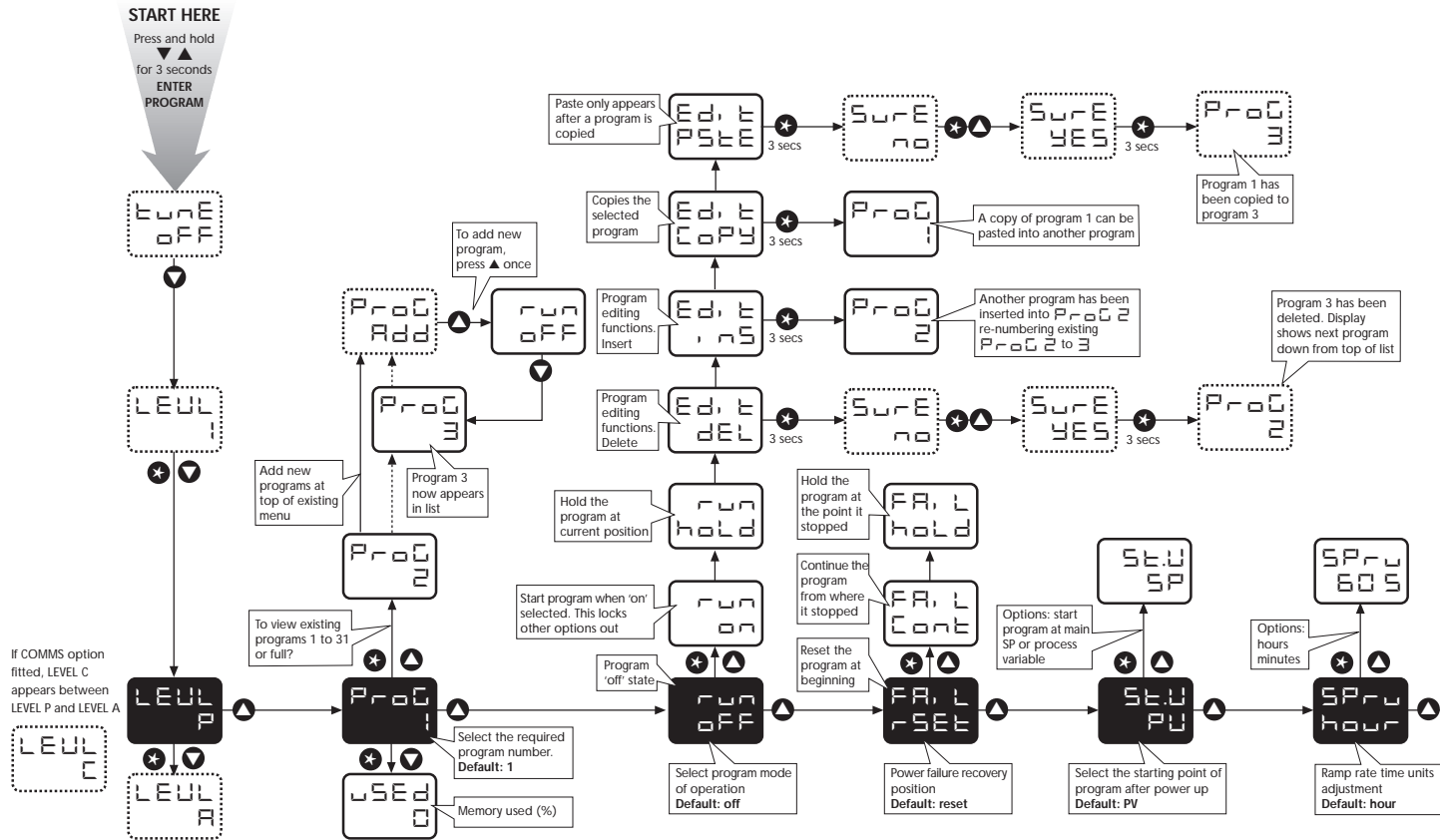

FUNCTION LIST (LEVEL P) PROGRAMMER

LEVEL P **LEVEL P**

Access Level P from Level 1. Press and hold * ▼

Function	Settings [Factory settings] shown in brackets
	Press ▲ or ▼ to change
ProG	Program number
run	Run Program
	[1] Add new programs (1 to 31)
	[oFF] Program not running
	on Run program
	hoLd Pause program
	Edit dEL Delete program † ❖
	Edit inS Insert new program †
	Edit CoPy Copy another program †
	Edit PStE Paste copied program †
Fail	Power failure recovery mode
	[rSEt] Reset to program start
	Cont Continue from interruption
	hoLd Hold at interruption (User re-start)
St.V	Program start value
	[PV] Process value
	SP Setpoint value
SPru	Ramp rate time units
	[hour] Ramp rate adjust in hours
	60 s Ramp rate adjust in minutes
SEG	Segment number
	[1] Add new segments (1 to 126) *

Function	Sub-functions	Settings [Factory settings] shown in brackets
	Press ▲ or ▼ to change	Press * ▲ or * ▼ to change
Type	Define segment type	SPrr Ramp to next target setpoint [100] Setpoint ramp rate Units per hour/minute (0-9990) (as set at SPru above)
		t.SP (Segment target setpoint) adjustable over instrument's configured range
		hb.u Hold back [oFF] sets the permitted band size for the measured value to deviate from the ramp setpoint before the program is 'held back' waiting for the measured value to catch up. (0.1 to 150 units)
		SoAK Hold setpoint for pre-set time [10] Soak time, adjust in minutes (cont.-1440) x 0.1
		Sint Step to new target setpoint (Set tSP as above)
		Loop Re-cycle program
		PCYC [1] Set number of program loops up to 999, or continuous loop *
		CALL Call up another program by number to import into this program
		Sub.P (nonE) Number of Program called at Call above
		Edit dEL Delete segment † ❖
		Edit inS Insert new segment †

- † See examples of EDIT procedures (page 18)
- ❖ Deleting a Program automatically re-numbers those programs with higher numbers
- * Until memory full. See page 11 for further explanation and memory allocation table on page 17.

Function

Settings [Factory settings] shown in brackets

Press ▲ or ▼ to change

Press ✱ ▲ or ✱ ▼ to change

E.oP

Event output

[nonE]

Function can be applied to each segment independently to trigger an output for the full duration of that segment. Setting blocked unless either or both outputs SP2A or SP3A have been configured as an **Event Output** in Level 2 or Level A respectively.

2d

SP2A de-energised to mark event

2E

SP2A energised to mark event

3d

SP3A de-energised to mark event

3E

SP3A energised to mark event

2d.3d

SP2A and SP3A de-energised to mark event

2E.3d

SP2A energised SP3A de-energised to mark event

2E.3E

SP2A and SP3A energised to mark event

2d.3E

SP2A de-energised SP3A energised to mark event

To Return to:

LEVL P Press and hold ▼

To Read % Programmer memory used:

USEd Press ✱ and ▼ together in LEVL P / ProG 1
1–100%

Memory Allocation Table

Segment type	Memory required
Ramp	4 Bytes
Ramp with Holdback	5 Bytes
Soak	2 Bytes
Step	3 Bytes
Loops (1–3)	1 Byte
Loops (4+)	2 Bytes
Call	1 Byte
Event Output	1 Byte
Program Header	1 Byte

Maximum capacity: 351 Bytes
31 Programs
126 Segments

Examples:

- | | |
|---|-----------|
| 1. 1 program of 58 Ramps and 58 Soaks | 349 Bytes |
| 2. 4 programs of 14 Ramps and 14 Soaks | 340 Bytes |
| 3. 31 programs of 2 Ramps and 1 Soak | 341 Bytes |
| 4. 2 programs of 10 Ramps, 10 Soaks, 2 Steps and 1 loop | 136 Bytes |

Memory Full Indication

Should the programmer memory capacity be reached during program configuration, the display will show 'FULL'

PROGRAMMING EXAMPLES

Program Edit Function

Make copy of Program 1 and paste as new Program 2

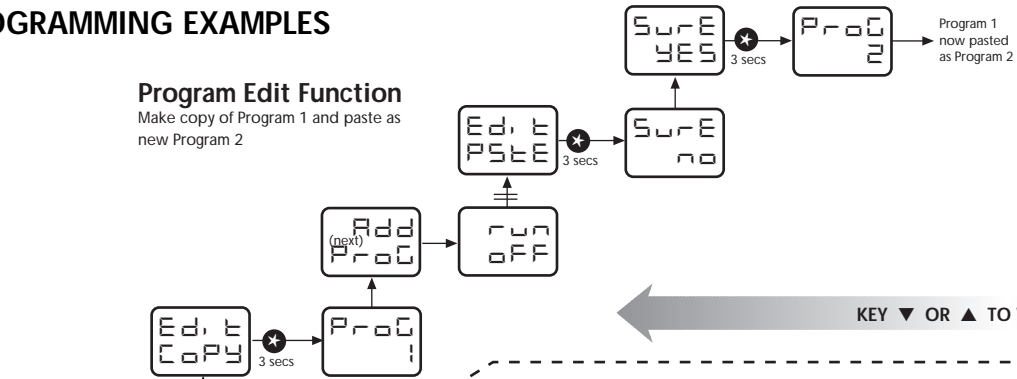

KEY

↑ Arrows drawn thus signify several key operations

Programmer functions shown as white characters on black background have Default settings

KEY ▼ OR ▲ TO VIEW FUNCTIONS

Program Segment Configuration

See Program 3 illustrated on page 13

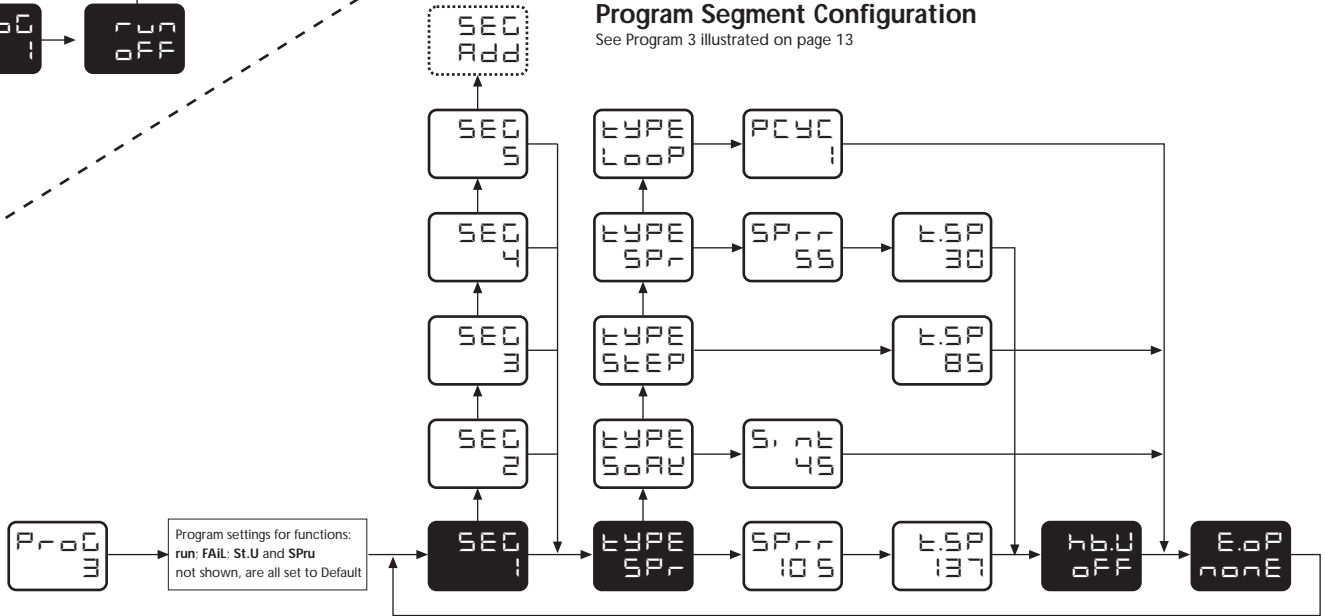

KEY ★ ▼ OR ▲ TOGETHER TO VIEW OR CHANGE SETTINGS

MECHANICAL INSTALLATION

The Controller is designed to be sleeve mounted in a 1/16 DIN panel cutout with only the front panel rated to NEMA4/IP66, provided that:

- the panel is smooth and the panel cutout is accurate;
- the mounting instructions are carefully followed.

DIN PANEL CUTOUT

1/16 DIN: 45.0mm +0.6 / -0.0 wide, 45.0mm +0.6 / -0.0 high

Maximum panel thickness 9.5mm

Minimum spacing 20mm vertical, 10mm horizontal

MOUNTING

To mount a Controller proceed as follows:

- 1 Check that the controller is correctly orientated and then slide the unit into the cutout.
- 2 Slide the panel clamp over the controller sleeve pressing it firmly against the panel until the controller is held firmly.
- 3 The controller front bezel and circuit board assembly can be unplugged from the sleeve. Grasp the bezel firmly by the recesses on each side and pull. A screwdriver can be used as a lever if required.
- 4 When refitting the bezel assembly it is important to press it firmly into the sleeve until the latch clicks in order to compress the gasket and seal to NEMA4X/IP66.

CLEANING

Wipe down with damp cloth (water only)



CAUTION: The controller should be isolated before removing or refitting it in its sleeve. Live circuits can hold a charge for short periods after isolation from voltage supply. Electrostatic precautions should be observed when handling the controller outside its sleeve.

DIMENSIONS

Bezel*		Behind Panel		Overall Length	Behind panel Length*
Width	Height	Width	Height		
51.0	51.0	44.8	44.8	116.2	106.7

Dimensions in mm

* includes gasket

ELECTRICAL INSTALLATION

(See important Safety Information page 20)

OUTPUT DEVICES

WARNING:

Three types of output device may be factory fitted to the controllers, and users must choose how to allocate these to outputs SP1 and SP2. (SP3 is always RLY). Check the model number and output configuration against the **Output Options Table** on page 8 before wiring the instrument and applying power.

1 Solid state relay drive (SSd1/SSd2)

6Vdc (nominal) 20mA max.

To switch remote SSR (or logic)

2 Miniature power relay (rLY/rLY1/rLY3)

2A/250V AC resistive, Form A/SPST contacts.

3 Analog Output (AnLG) (isolated)

Specify: 4–20mA 500Ω max +/- 0.1% fs typical

0–5Vdc 10mA (500Ω min) +/- 0.1% fs typical

0–10Vdc 10mA (1KΩ min) +/- 0.1% fs typical

SUPPLY VOLTAGE

100–240V 50–60HZ 6.0VA (nominal)

+/- 10% maximum permitted fluctuation

WIRING THE CONNECTOR

Prepare the cable carefully, remove a maximum of 8mm insulation and ideally tin to avoid bridging. Prevent excessive cable strain. Maximum recommended wire size: 32/0.2mm 1.0mm² (18AWG).

INDUCTIVE LOADS

To prolong relay contact life and suppress interference it is recommended engineering practice to fit a snubber (0.1uf/100 ohms) between relay output terminals.

CAUTION:

Snubber leakage current can cause some electro-mechanical devices to be held ON. Check with the manufacturers specifications.

EN61010 - /CSA 22.2 No 1010.1 92

Compliance shall not be impaired when fitted to the final installation.
Designed to offer a minimum of Basic Insulation only.

The body responsible for the installation is to ensure that supplementary insulation suitable for Installation Category II or III is achieved when fully installed.

To avoid possible hazards, accessible conductive parts of the final installation should be protectively earthed in accordance with EN61010 for Class 1 Equipment.

Output wiring should be within a Protectively Earthed cabinet.

- * Sensor sheaths should be bonded to protective earth or not be accessible.

Live parts should not be accessible without the use of a tool.

When fitted to the final installation, an IEC/CSA APPROVED disconnecting device should be used to disconnect both LINE and NEUTRAL conductors simultaneously.

A clear instruction shall be provided not to position the equipment so that it is difficult to operate the disconnecting device.

* EMC Immunity

EMC immunity may be improved by fitting large Ferrite cores around the sensor cables at the point where they enter the cabinet and an earth bond is recommended.

TYPICAL APPLICATION

In this example the load temperature is monitored by a temperature transducer/transmitter which provides a 4–20mA input signal to the controller. The 4–20mA output has been allocated to SP1 to drive an SCR power controller providing a phase angle controlled output to the heater.

F1 Fuse: 1A time lag type to IEC127. CSA/UL rating 250Vac

F2 Fuse: High Rupture Capacity (HRC) Suitable for maximum rated load current

S1 Switch: IEC/CSA/UL Approved disconnecting device.

TYPICAL APPLICATION

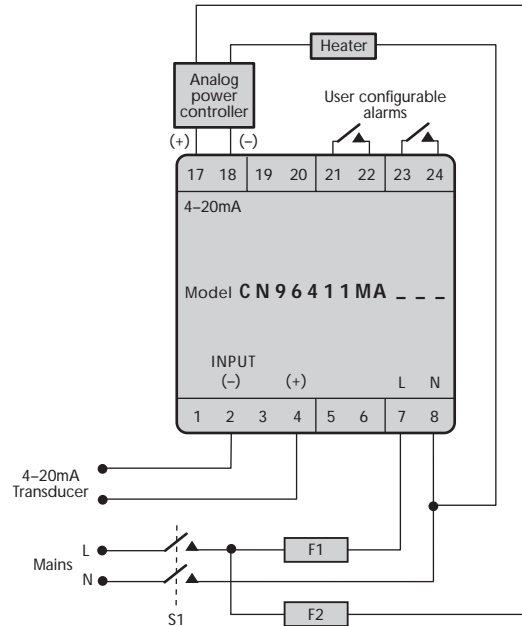

SAFETY INFORMATION

INSTALLATION

Designed for use:

UL873 - only in products where the acceptability is determined by Underwriters Laboratories Inc.

EN61010-1 / CSA 22.2 No 1010.1 - 92

To offer a minimum of Basic Insulation only.

Suitable for installation within Category II and III and Pollution Degree 2.

SEE ELECTRICAL INSTALLATION Page 19



It is the responsibility of the installation engineer to ensure this equipment is installed as specified in this manual and is in compliance with appropriate wiring regulations.

CONFIGURATION

All functions are front selectable, it is the responsibility of the installing engineer to ensure that the configuration is safe. Use the program lock to protect critical functions from tampering.

ULTIMATE SAFETY ALARMS

Do not use SP2/SP3 as the sole alarm where personal injury or damage may be caused by equipment failure.

INPUT OPTIONS

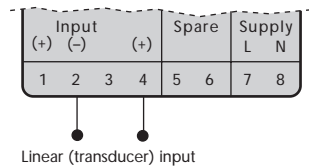
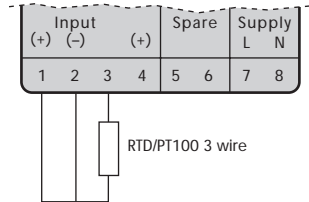
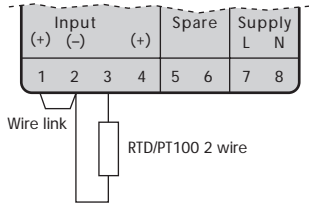
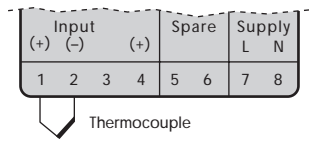

Standard Input Code

C N 9 6 --- T R

Linear Input Codes

C N 9 6 --- M A = 4-20mA

C N 9 6 --- 5 V = 0-5V

C N 9 6 --- 1 0 V = 0-10V

OUTPUT: HARDWARE OPTIONS & TERMINATIONS

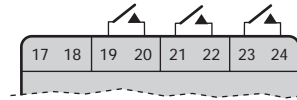

Model Output Codes

C N 9 6 1 1 1

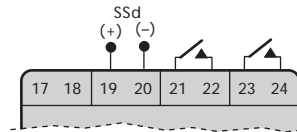

C N 9 6 2 1 1

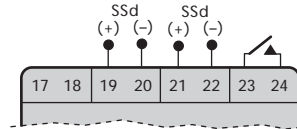

C N 9 6 2 2 1

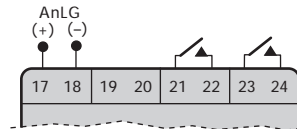

C N 9 6 4 1 1 = 4-20mA

C N 9 6 5 1 1 = 0-5V

C N 9 6 6 1 1 = 0-10V

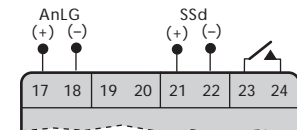

C N 9 6 4 2 1 = 4-20mA

C N 9 6 5 2 1 = 0-5V

C N 9 6 6 2 1 = 0-10V

Relay = 1 SSd = 2 Analog = 4/5/6

The analog output always replaces the output on terminals 19 & 20.

INPUT SENSOR SELECTION

Temperature sensors

Thermocouples	Description	Sensor range	Linearity
tC b	Pt-30%Rh/Pt-6%Rh	0 to 1800 °C	2.0 *
tC E	Chromel/Con	0 to 600 °C	0.5
tC J	Iron/Constantan	0 to 800 °C	0.5
tC K	Chromel/Alumel	-50 to 1200 °C	0.25*
tC L	Fe/Konst	0 to 800 °C	0.5
tC n	NiCrosil/NiSil	-50 to 1200 °C	0.25*
tC r	Pt-13%Rh/Pt	0 to 1600 °C	2.0*
tC s	Pt-10%Rh/Pt	0 to 1600 °C	2.0*
tC t	Copper/Con	-200 / 250 °C	0.25*
Resistance thermometer rtd 2/3 wire	Pt100/RTD-2/3	-200 / 400 °C	0.25*

- Notes:**
- Linearity: 5-95% sensor range
 - * Linearity B:5° (70° - 500°C) K/N:1° >350°C
exceptions: R/S: 5° <300°C T:1° < -25° >150°C
RTD/Pt100: 0.5° <-100°C

Linear input (specification)

Maximum recommended display resolution: 1mV / 500°

Linear Input	Typical accuracy	Range
0-50mV	+/- 0.1%	-199 to 9999
4-20mA	+/- 0.1%	-199 to 9999
0-5	+/- 0.1%	-199 to 9999
0-10V	+/- 0.1%	-199 to 9999

SPECIFICATION

Thermocouple

9 types
Standards: IEC 584-1-1:EN60584-1
CJC rejection: 20:1 (0.05°/°C) typical
External resistance: 100Ω maximum

Resistance thermometer

RTD-2/Pt100 2 wire

Standards:

IEC 751:EN60751
(100Ω 0°C/138.5Ω 100°C Pt)
0.2mA maximum

Bulb current:

0 to 50mV

Linear process inputs see *Linear input (specification)*

mV range:

Applicable to all inputs SM = sensor maximum

Calibration accuracy:

±0.25%SM ±1°C

Sampling frequency:

input 10Hz, CJC 2 sec.

Common mode rejection:

Negligible effect up to 140dB, 240V, 50-60Hz

Series mode rejection:

60dB, 50-60Hz

Temperature coefficient:

50ppm/°C SM typical

Reference conditions:

22°C ±2°C, rated voltage after 15 minutes
settling time.

Output devices check configuration

SSd1 and SSd2:

solid state relay driver: To switch a remote SSR
6Vdc (nominal) 20mA non-isolated

Miniature power relay:

form A/SPST contacts (AgCdO)

rLY, rLY1 and rLY3:

2A/250ac resistive load

Analog output:

4-20mA 500Ω max +/- 0.1% fs typical
0-5Vdc 10mA (500Ω min) +/- 0.1% fs typical
0-10Vdc 10mA (1KΩ min) +/- 0.1% fs typical

General

Displays:

Upper, 4 Digits, high brightness
green LED. 10mm (0.4") high.
Lower, 4 Digits, high brightness Orange LED
9mm (0.35") high
Digital range -199 to 9999
Hi-res mode -199.9 to 999.9
LED output indicators - flashing
SP1 square, green; SP2/SP3 round, red

Keypad:

3 elastomeric buttons

Environmental

Humidity:

Max 95% (non condensing)

Altitude:

up to 2000M

Installation:

Categories II and III

Pollution:

Degree II

Protection:

NEMA 4X, IP66 (Front panel only)

EMC emission:

EN50081-1 FCC Rules 15 subpart J Class A

EMC immunity:

EN50082-2

Ambient:

0-50°C (32-130°F)

Mouldings:

flame retardant polycarbonate

Weight:

180g (6.4 oz)

APPENDIX 1

(Specify Model Number)		(Both Outputs can be either Reverse or Direct Acting)		
Model No.	Description	Output 1	Output 2	Output 3
CN96111(*)	1/16 DIN Dual Display Controller	Relay	Relay	Relay
CN96211(*)	1/16 DIN Dual Display Controller	dc Pulse	Relay	Relay
CN96221(*)	1/16 DIN Dual Display Controller	dc Pulse	dc Pulse	Relay
CN96411(*)	1/16 DIN Dual Display Controller	4:20mA	Relay	Relay
CN96421(*)	1/16 DIN Dual Display Controller	4:20mA	dc Pulse	Relay
CN96511(*)	1/16 DIN Dual Display Controller	5 VDC	Relay	Relay
CN96521(*)	1/16 DIN Dual Display Controller	5 VDC	dc Pulse	Relay
CN96611(*)	1/16 DIN Dual Display Controller	10 VDC	Relay	Relay
CN96621(*)	1/16 DIN Dual Display Controller	10 VDC	dc Pulse	Relay

* Specify input type. Add **TR** for standard thermocouple/RTD or for a dedicated process input add **MA, 5V or 10V**

OMEGACARESM extended warranty program is available for models shown on this page. Ask your sales representative for full details when placing an order.

Additional Options

Suffix	Description
-C2	RS-232 Communications
-C4	RS-485 Communications

Note: one communications option can be ordered per unit.

Field installable communications boards can be installed in the field

Field Installable Boards and Accessories

Model Number	Description
BD9-C2	RS-232 Communications
BD9-C4	RS-485 Communications
CN9-SW-DEMO	Demonstration software for Windows 95 and Windows NT
BD9-PROTOCOL*	The Modbus Protocol Manual is not required when using the CN9-SW software
CN9-SW	Software for either RS-232 or RS-485 communications (refer to specifications). Compatible with Windows 95, 98 and Windows NT
TP4	Trim plate adapter, 1/16 to 1/4 DIN panel cutout
TP6	Trim plate adapter, 1/16 to 1/8 DIN panel cutout
CNQUENCHARC	120/240 Vac Snubber used for Inductive Loads
CN9-C2-CABLE-12	3.66 m (12') RS-232 Cable with Female DB-9 Connector
CN9-C2-CABLE-24	7.32 m (24') RS-232 Cable with Female DB-9 Connector

* *Note: This protocol manual provides the address information necessary to communicate with the CN9300/CN9400/CN9500/CN9600 series controllers, with communications options installed, when interacting with custom or other commercially available software.*

NOTES:

WARRANTY/ DISCLAIMER

OMEGA ENGINEERING, INC. warrants this unit to be free of defects in materials and workmanship for a period of 13 months from date of purchase. OMEGA's Warranty adds an additional one (1) month grace period to the normal one (1) year product warranty to cover handling and shipping time. This ensures that OMEGA's customers receive maximum coverage on each product.

If the unit malfunctions, it must be returned to the factory for evaluation. OMEGA's Customer Service Department will issue an Authorized Return (AR) number immediately upon phone or written request. Upon examination by OMEGA, if the unit is found to be defective, it will be repaired or replaced at no charge. OMEGA's WARRANTY does not apply to defects resulting from any action of the purchaser, including but not limited to mishandling, improper interfacing, operation outside of design limits, improper repair, or unauthorized modification. This WARRANTY is VOID if the unit shows evidence of having been tampered with or shows evidence of having been damaged as a result of excessive corrosion; or current, heat, moisture or vibration; improper specification; misapplication; misuse or other operating conditions outside of OMEGA's control. Components which wear are not warranted, including but not limited to contact points, fuses, and triacs.

OMEGA is pleased to offer suggestions on the use of its various products. However, OMEGA neither assumes responsibility for any omissions or errors nor assumes liability for any damages that result from the use of its products in accordance with information provided by OMEGA, either verbal or written. OMEGA warrants only that the parts manufactured by it will be as specified and free of defects. OMEGA MAKES NO OTHER WARRANTIES OR REPRESENTATIONS OF ANY KIND WHATSOEVER, EXPRESS OR IMPLIED, EXCEPT THAT OF TITLE, AND ALL IMPLIED WARRANTIES INCLUDING ANY WARRANTY OF MERCHANTABILITY AND FITNESS FOR A PARTICULAR PURPOSE ARE HEREBY DISCLAIMED. LIMITATION OF LIABILITY: The remedies of purchaser set forth herein are exclusive, and the total liability of OMEGA with respect to this order, whether based on contract, warranty, negligence, indemnification, strict liability or otherwise, shall not exceed the purchase price of the component upon which liability is based. In no event shall OMEGA be liable for consequential, incidental or special damages.

CONDITIONS: Equipment sold by OMEGA is not intended to be used, nor shall it be used: (1) as a "Basic Component" under 10 CFR 21 (NRC), used in or with any nuclear installation or activity; or (2) in medical applications or used on humans. Should any Product(s) be used in or with any nuclear installation or activity, medical application, used on humans, or misused in any way, OMEGA assumes no responsibility as set forth in our basic WARRANTY/ DISCLAIMER language, and, additionally, purchaser will indemnify OMEGA and hold OMEGA harmless from any liability or damage whatsoever arising out of the use of the Product(s) in such a manner.

RETURN REQUESTS/INQUIRIES

Direct all warranty and repair requests/inquiries to the OMEGA Customer Service Department. BEFORE RETURNING ANY PRODUCT(S) TO OMEGA, PURCHASER MUST OBTAIN AN AUTHORIZED RETURN (AR) NUMBER FROM OMEGA'S CUSTOMER SERVICE DEPARTMENT (IN ORDER TO AVOID PROCESSING DELAYS). The assigned AR number should then be marked on the outside of the return package and on any correspondence. The purchaser is responsible for shipping charges, freight, insurance and proper packaging to prevent breakage in transit.

FOR WARRANTY RETURNS, please have the following information available BEFORE contacting OMEGA:

1. Purchase Order number under which the product was PURCHASED,
2. Model and serial number of the product under warranty, and
3. Repair instructions and/or specific problems relative to the product.

FOR NON-WARRANTY REPAIRS, consult OMEGA for current repair charges. Have the following information available BEFORE contacting OMEGA:

1. Purchase Order number to cover the COST of the repair,
2. Model and serial number of the product, and
3. Repair instructions and/or specific problems relative to the product.

OMEGA's policy is to make running changes, not model changes, whenever an improvement is possible. This affords our customers the latest in technology and engineering. OMEGA is a registered trademark of OMEGA ENGINEERING, INC.

© Copyright 2001 OMEGA ENGINEERING, INC. All rights reserved. This document may not be copied, photocopied, reproduced, translated, or reduced to any electronic medium or machine-readable form, in whole or in part, without the prior written consent of OMEGA ENGINEERING, INC.