



# iSeries®



# User's Guide

**Shop on line at**

**omega.com®**

Ω OMEGA®

*omega.com*

*e-mail: info@omega.com*

*iSeries info:*

*omega.com/specs/iseries*

*For latest product manuals*

*omegamannual.info*

**Process/Strain Gauge Monitor**

**DPiS8, DPiS16, DPiS32**

**Process/Strain Gauge Limit Alarm**

**CNiS8-AL, CNiS8C-AL, CNiS8C-AL,**

**CNiS16-AL, CNiS16D-AL, CNiS32-AL**



Ω-OMEGA®

**OMEGAnet® On-Line Service**  
[www.omega.com](http://www.omega.com)

**Internet e-mail**  
[info@omega.com](mailto:info@omega.com)

### **Servicing North America:**

**USA:**  
ISO 9001 Certified

One Omega Drive, P.O. Box 4047  
Stamford CT 06907-0047  
TEL: (203) 359-1660 FAX: (203) 359-7700  
e-mail: [info@omega.com](mailto:info@omega.com)

**Canada:**

976 Bergar  
Laval (Quebec) H7L 5A1  
TEL: (514) 856-6928 FAX: (514) 856-6886  
e-mail: [info@omega.ca](mailto:info@omega.ca)

### **For immediate technical or application assistance:**

**USA and Canada:**

Sales Service: 1-800-826-6342 / 1-800-TC-OMEGA®  
Customer Service: 1-800-622-2378 / 1-800-622-BEST®  
Engineering Service: 1-800-872-9436 / 1-800-USA-WHEN®

**Mexico and  
Latin America:**

TEL: (001)800-TC-OMEGA® FAX: (001) 203-359-7807  
En Español: (001) 203-359-7803  
e-mail: [espanol@omega.com](mailto:espanol@omega.com)

### **Servicing Europe:**

**Benelux:**

Postbus 8034, 1180 LA Amstelveen, The Netherlands  
TEL: +31 20 3472121 FAX: +31 20 6434643  
Toll Free in Benelux: 0800 0993344  
e-mail: [sales@omegaeng.nl](mailto:sales@omegaeng.nl)

**Czech Republic:**

Frystatska 184, 733 01 Karviná  
TEL: +420 59 6311899 FAX: +420 59 6311114  
e-mail: [info@omegashop.cz](mailto:info@omegashop.cz)

**France:**

11, rue Jacques Cartier, 78280 Guyancourt  
TEL: +33 1 61 37 29 00 FAX: +33 1 30 57 54 27  
Toll Free in France: 0800 466 342  
e-mail: [sales@omega.fr](mailto:sales@omega.fr)

**Germany/Austria:**

Daimlerstrasse 26, D-75392 Deckenpfronn, Germany  
TEL: +49 7056 9398-0 FAX: +49 7056 9398-29  
Toll Free in Germany: 0800 639 7678  
e-mail: [info@omega.de](mailto:info@omega.de)

**United Kingdom:**  
ISO 9002 Certified

One Omega Drive  
River Bend Technology Centre  
Northbank, Irlam Manchester M44 5BD United Kingdom  
TEL: +44 161 777 6611 FAX: +44 161 777 6622  
Toll Free in England: 0800 488 488  
e-mail: [sales@omega.co.uk](mailto:sales@omega.co.uk)

It is the policy of OMEGA to comply with all worldwide safety and EMC/EMI regulations that apply. OMEGA is constantly pursuing certification of its products to the European New Approach Directives. OMEGA will add the CE mark to every appropriate device upon certification.

The information contained in this document is believed to be correct, but OMEGA Engineering, Inc. accepts no liability for any errors it contains, and reserves the right to alter specifications without notice.

**WARNING:** These products are not designed for use in, and should not be used for, patient-connected applications.



This device is marked with the international caution symbol. It is important to read the Setup Guide before installing or commissioning this device as the guide contains important information relating to safety and EMC.

# TABLE OF CONTENTS

<b>Part 1: Introduction</b> .....	<b>2</b>
1.1 Description .....	2
1.2 Safety Considerations .....	3
1.3 Before You Begin .....	4
<b>Part 2: Setup</b> .....	<b>5</b>
2.1 Front Panel .....	5
2.2 Rear Panel Connections .....	5
2.3 Electrical Installation .....	7
2.3.1 Power Connections .....	7
2.3.2 Process Current .....	8
2.3.3 Process Voltage .....	8
2.3.4 Strain Gauge .....	9
2.3.5 Wiring Outputs .....	10
<b>Part 3: Operation: Configuration Mode</b> .....	<b>12</b>
3.1 Introduction .....	12
Turning your Instrument On for the First Time	
Buttons Functions in Configuration Mode	
3.2 Menu Configuration .....	13
3.2.1 ID Number .....	14
3.2.2 Set Points Menu .....	15
3.2.3 Configuration Menu .....	16
3.2.4 Input Type Menu .....	16
3.2.5 Reading Configuration Menu .....	18
3.2.6 Input/Reading (Scale and Offset) Menu .....	21
3.2.7 Alarm 1 Menu .....	25
3.2.8 Alarm 2 Menu .....	29
3.2.9 Setpoint Deviation Menu .....	30
3.2.10 ID Code Menu .....	31
3.2.11 Communication Option Menu .....	33
3.2.12 Display Color Selection Menu .....	40
<b>Part 4: Specifications</b> .....	<b>43</b>
<b>Part 5: Factory Preset Values</b> .....	<b>45</b>
<b>CE APPROVAL INFORMATION</b> .....	<b>47</b>

## LIST OF FIGURES:

Figure 2.1	Front Panel Display .....	5
Figure 2.2	Rear Panel Power Connections .....	5
Figure 2.3	Rear Panel Input Connections .....	6
Figure 2.4	Main Power Connections .....	7
Figure 2.5	Process Current Wiring Hookup .....	8
	Process Voltage	
Figure 2.6	a) Process Voltage with Sensor Excitation .....	8
	b) Process Voltage without Sensor Excitation .....	8
	Strain Gauge	
Figure 2.7	a) 4-Wire Voltage Input with Internal Excitation.....	9
	b) 4-Wire Bridge Input with External Excitation.....	9
Figure 2.8	a) 6-Wire Voltage Input with Internal Excitation.....	9
	b) 6-Wire Bridge Input with External Excitation.....	9
Figure 2.9	4-Wire Voltage Input with Internal Excitation .....	10
Figure 2.10	a) Mechanical Relay and SSR Outputs Wiring Hookup .....	10
	b) Pulse Output Wiring Hookup .....	10
Figure 2.11	a) RS-232 Output Wiring Hookup .....	11
	b) RS-485 Output Wiring Hookup .....	11
Figure 2.12	a) Excitation Output.....	11
	b) Top View Location of S2 .....	11
	c) Top View Location of S2 on 1/8 DIN Compact Unit .....	11
Figure 3.1	Flow Chart for ID and Setpoints Menu .....	13
Figure 3.2	Flow Chart for Configuration Menu .....	16
Figure 3.3	Flow Chart for Input Type Menu .....	16
Figure 3.4	Flow Chart for Reading Configuration Menu .....	18
Figure 3.5	Flow Chart for Alarm 1 Menu .....	25
Figure 3.6	Flow Chart for Alarm 2 Menu .....	29
Figure 3.7	Flow Chart for Setpoint Deviation Menu .....	30
Figure 3.8	Flow Chart for ID Code Menu .....	31
Figure 3.9	Flow Chart for Communication Option Menu .....	33
Figure 3.10	Flow Chart for Display Color Selection Menu.....	40

## LIST OF TABLES:

Table 2.1	Front Panel Display .....	5
Table 2.2	Rear Panel Connector .....	6
Table 2.3	Power Connections .....	7
Table 2.4	Jumper Connections .....	11
Table 3.1	Button Function in Configuration Mode.....	12
Table 3.2	Conversion Table.....	22
Table 3.3	Input Resolution Multiplier .....	22
Table 5.1	Factory Preset Values .....	45

## NOTES, WARNINGS and CAUTIONS

Information that is especially important to note is identified by following labels:

- **NOTE**
- **WARNING or CAUTION**
- **IMPORTANT**
- **TIP**



**NOTE:** Provides you with information that is important to successfully setup and use the Programmable Digital Meter.



**CAUTION or WARNING:** Tells you about the risk of electrical shock.



**CAUTION, WARNING or IMPORTANT:** Tells you of circumstances or practices that can effect the instrument's functionality and must refer to accompanying documents.



**TIP:** Provides you helpful hints.

# PART 1

## INTRODUCTION

### 1.1 Description

**Note**

This device can be purchased as monitor (read process value only) or as a controller.

- The iSeries Strain and Process monitors can measure a wide variety of DC voltage and current inputs for all common load cells, pressure transducers and strain gauge type of transducer. The voltage /current inputs are fully scaleable to virtually all engineering units, with selectable decimal point, perfect for use with pressure, flow or other process input.
- The iSeries monitor features a large, three color programmable display with capability to change a color every time when Alarm is triggered. The standard features include built-in excitation for transducers, selectable as 10V @ 60 mA or 5 V @ 40 mA. (Built-in excitation is not available with optional isolated RS-232/485 Serial Communication). Universal power supply accepts 90 to 240. Low voltage power option accepts 24 Vac or 12 to 36 Vdc.
- Options include programmable RS-232 or RS-485 serial communication and ethernet with an embedded web server.

## 1.2 Safety Considerations

---



This device is marked with the **international caution symbol**. It is **important to read** this manual before installing or commissioning this device as it contains important information relating to **Safety and EMC** (Electromagnetic Compatibility).

---

This instrument is a panel mount device protected in accordance with EN 61010-1:2001, electrical safety requirements for electrical equipment for measurement, control and laboratory. Installation of this instrument should be done by qualified personnel. In order to ensure safe operation, the following instructions should be followed.



This instrument has **no power-on switch**. An external **switch or circuit-breaker** shall be included in the building installation as a disconnecting device. It shall be marked to indicate this function, and it shall be in close proximity to the equipment within easy reach of the operator. The switch or circuit-breaker shall not interrupt the Protective Conductor (Earth wire), and it shall meet the relevant requirements of IEC 947-1 and IEC 947-3 (International Electrotechnical Commission). The switch shall not be incorporated in the main supply cord.



Furthermore, to provide protection against **excessive energy** being drawn from the main supply in case of a fault in the equipment, an **overcurrent** protection device shall be installed.



- Do not exceed voltage rating on the label located on the top of the instrument housing.
- Always disconnect power before changing signal and power connections.
- Do not use this instrument on a work bench without its case for safety reasons.
- Do not operate this instrument in flammable or explosive atmospheres.
- Do not expose this instrument to rain or moisture.
- Unit mounting should allow for adequate ventilation to ensure instrument does not exceed operating temperature rating.
- Use electrical wires with adequate size to handle mechanical strain and power requirements. Install without exposing bare wire outside the connector to minimize electrical shock hazards.

### EMC Considerations

- Whenever EMC is an issue, always use shielded cables.
- Never run signal and power wires in the same conduit.
- Use signal wire connections with twisted-pair cables.
- Install Ferrite Bead(s) on signal wires close to the instrument if EMC problems persist.

**Failure to follow all instructions and warnings may result in injury!**

## 1.3 Before You Begin

### Inspecting Your Shipment:

Remove the packing slip and verify that you have received everything listed. Inspect the container and equipment for signs of damage as soon as you receive the shipment. Note any evidence of rough handling in transit. Immediately report any damage to the shipping agent. The carrier will not honor damage claims unless all shipping material is saved for inspection. After examining and removing the contents, save the packing material and carton in the event reshipment is necessary.

### Customer Service:

If you need assistance, please call the nearest Customer Service Department, listed in this manual.

### Manuals, Software:

The latest Operation and Communication Manual as well as free software and ActiveX controls are available at **the website listed on the cover page of this manual or on the CD-ROM enclosed with your shipment.**



For first-time users: Refer to the QuickStart Manual for basic operation and set-up instructions.



If you have the Serial Communications/Ethernet Option you can easily configure the controller on your computer or on-line.

### To Reset the Meter:



When the monitor is in the "MENU" Mode, **push ▼ once** to direct monitor one step backward of the top menu item.

**Push ▼ twice** to reset monitor, prior to resuming "Run" Mode except after "Alarms", that will go to the "Run" Mode without resetting the monitor.



**PART 2**  
**SETUP**  
**2.1 Front Panel**

**Note** Refer to the Quick Start Guide for assembly and disassembly instructions.

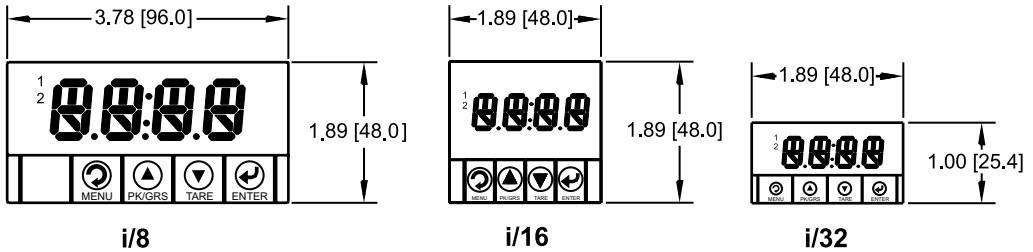

**Figure 2.1 Front Panel Display**

**Table 2.1 Front Panel Annunciators**

<b>1</b>	Setpoint 1/ Alarm 1 indicator
<b>2</b>	Setpoint 2/ Alarm 2 indicator
	Changes display to Configuration Mode and advances through menu items*
	Used in Program Mode and Peak or Gross Recall*
	Used in Program Mode and to tare your reading*
	Accesses submenus in Configuration Mode and stores selected values*

\* See Part 3 Operation: Configuration Mode

**2.2 Rear Panel Connections**

The rear panel connections are shown in Figures 2.2 and 2.3.

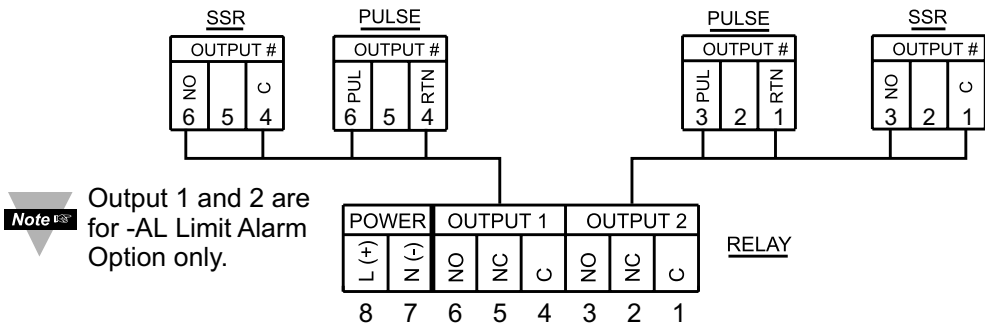

**Figure 2.2 Rear Panel Power Connections**

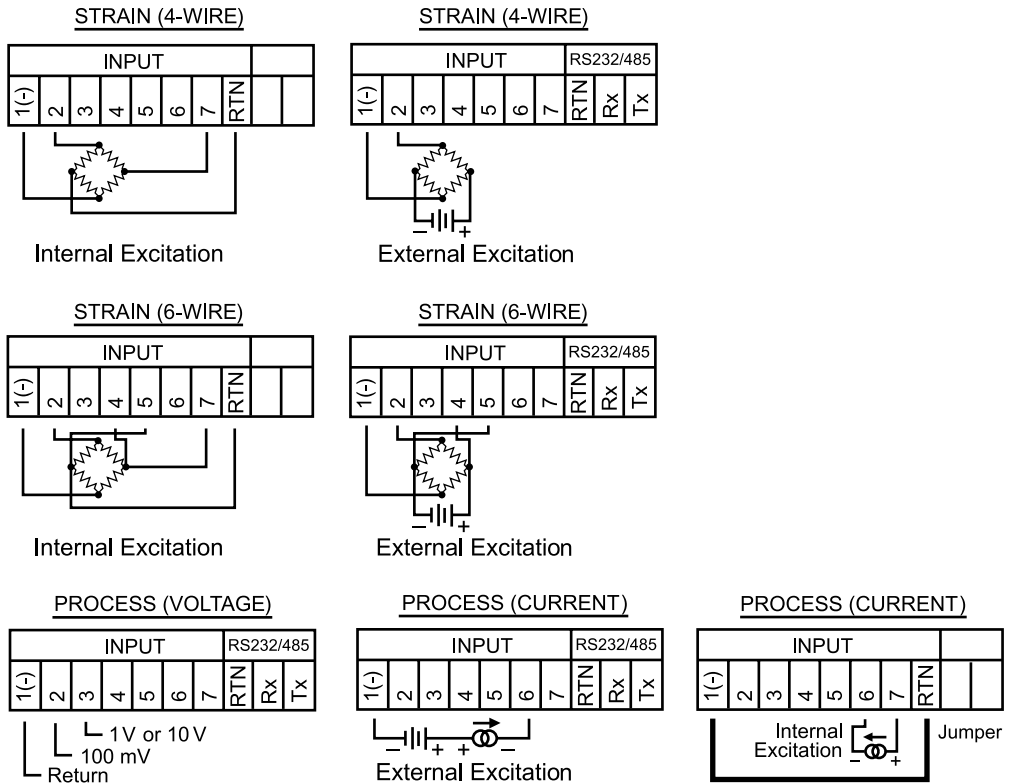

**Figure 2.3 Rear Panel Input Connections**

**Table 2.2 Rear Panel Connector**

<b>POWER</b>	AC/DC Power Connector: All models
<b>INPUT</b>	Input Connector: All models PR (Process) / ST (Strain)
<b>OUTPUT 1</b>	Based on one of the following models: Relay SPDT Solid State Relay Pulse
<b>OUTPUT 2</b>	Based on one of the following models: Relay SPDT Solid State Relay Pulse
<b>OPTION</b>	Based on one of the following models: RS-232C or RS-485 programmable Excitation

**Note**

Output 1 and 2 are for -AL Limit Alarm Option only.

## 2.3 Electrical Installation

### 2.3.1 Power Connections



**Caution:** Do not connect power to your device until you have completed all input and output connections. Failure to do so may result in injury!

Connect the main power connections as shown in Figure 2.4.

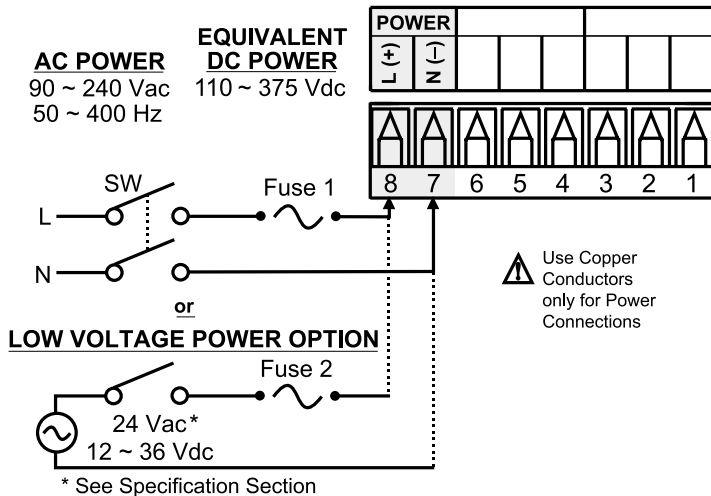

**Figure 2.4 Main Power Connections**

**Table 2.3 Fuse Requirements**

FUSE	Connector	Output Type	For 115Vac	For 230Vac	DC
FUSE 1	Power	N/A	100 mA(T)	100 mA(T)	100 mA(T)
FUSE 2	Power	N/A	N/A	N/A	400 mA(T)



For the low voltage power option, in order to maintain the same degree of protection as the standard high voltage input power units (90 - 240 Vac), always use a Safety Agency Approved DC or AC source with the same Overvoltage Category and pollution degree as the standard AC unit (90 - 240 Vac).



The Safety European Standard EN61010-1 for measurement, control, and laboratory equipment requires that fuses must be specified based on IEC127. This standard specifies for a Time-lag fuse, the letter code "T". The above recommended fuses are of the type IEC127-2-sheet III. Be aware that there are significant differences between the requirements listed in the UL 248-14/CSA 248.14 and the IEC 127 fuse standards. As a result, no single fuse can carry all approval listings. A 1.0 Amp IEC fuse is approximately equivalent to a 1.4 Amp UL/CSA fuse. It is advised to consult the manufacturer's data sheets for a cross-reference.

### 2.3.2 Process Current

The figure below shows the wiring hookup for Process Current 0 – 20 mA.

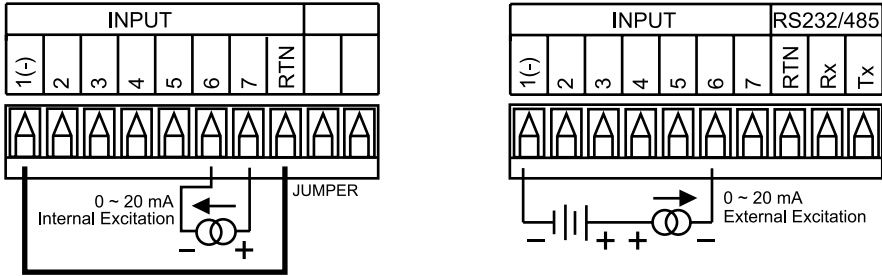

**Figure 2.5 Process Current Wiring Hookup (Internal and External Excitation)**

### 2.3.3 Process Voltage

The figure below shows the wiring hookup for Process Voltage 0 – 100 mV, 0 – 1 V, 0 – 10 V.

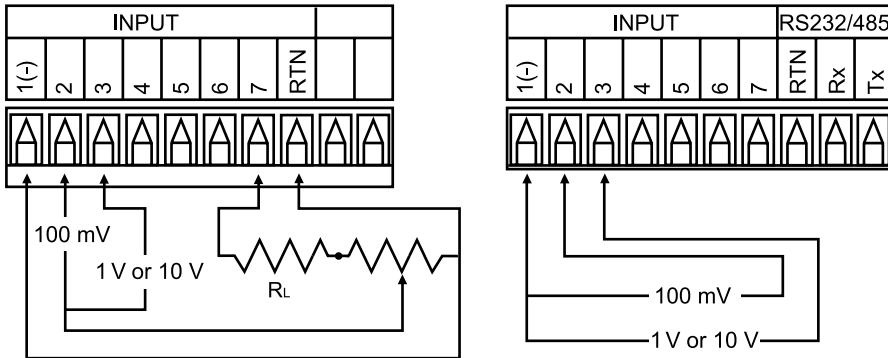

**Figure 2.6**

- a) Process Voltage Wiring Hookup with Sensor Excitation**      **b) Process Voltage Wiring Hookup without Sensor Excitation**

$R_L$  - Voltage limited resistor, which allows to convert 24 Vdc internal excitation voltage to the appropriate process input value. For instance: if the potentiometer value is equal to 10 k $\Omega$ , the minimum  $R_L$  is 14 k $\Omega$  for 10 V process input.

When configuring your instrument, select Process Type in the Input Type Menu (see Part 3).

### 2.3.4 Strain Gauge

The figure below shows the wiring hookup for 4-wire bridge input.

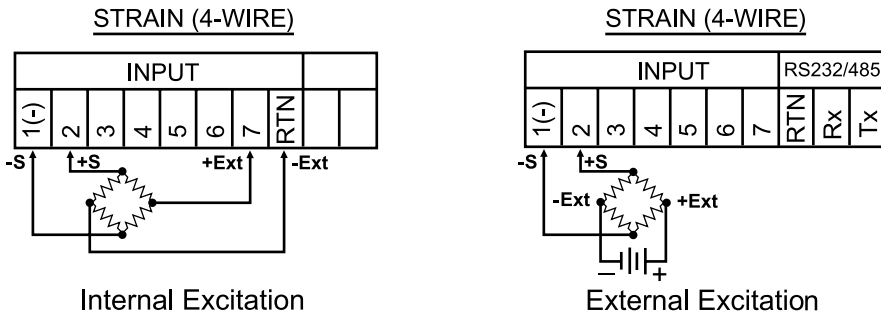

**Figure 2.7**

**a) 4-Wire Voltage/Bridge Input with Internal Excitation Wiring Hookup**

**b) 4-Wire Bridge Input with External Excitation Wiring Hookup**

In 4-Wire connections the voltage drop across long excitation lead wires of strain gauge bridge may cause measurement errors. The output of a strain gauge bridge also depends on the stability of excitation voltage. To correct for voltage drop and changes in excitation voltage, 6-wire input configuration and ratio measurement are used.

**Note** In order for the Ratiometric to work properly, the External Excitation should not drop below 4.6 Vdc.

The figure below shows 6-wire hookup for 6-wire bridge input.

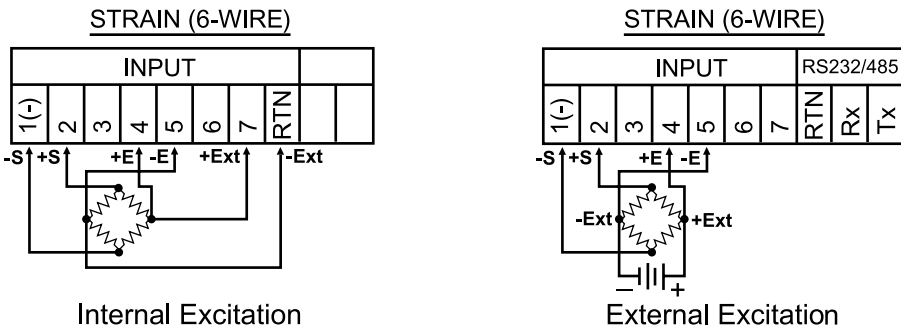
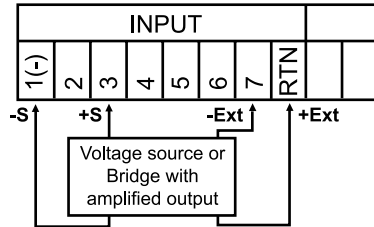

**Figure 2.8**

**a) 6-Wire Bridge Input with Internal Excitation and Ratio Measurement Wiring Hookup**

**b) 6-Wire Bridge Input with External Excitation and Ratio Measurement Wiring Hookup**

The figure below shows Voltage (bridge with amplified output) input with internal excitation.

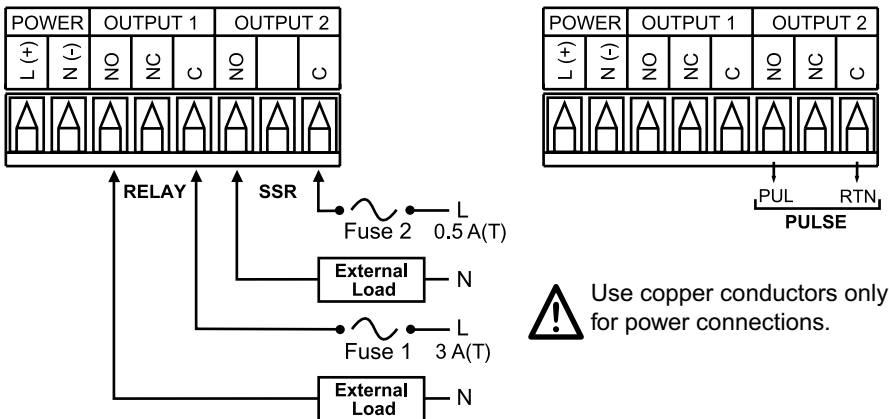

**Figure 2.9 4-Wire Voltage Input (Bridge with Amplified Output) with Internal Excitation**

Where: +S: signal plus, -S: signal return, +Ext: excitation plus, -Ext: excitation return  
+E: plus excitation sense, -E: minus excitation sense.

### 2.3.5 Wiring Outputs

This meter, if ordered with -AL Limit Alarm Option, has two, factory installed, outputs. The SPDT Mechanical Relay, SPST Solid State Relay and Pulse Output Connection are shown below.

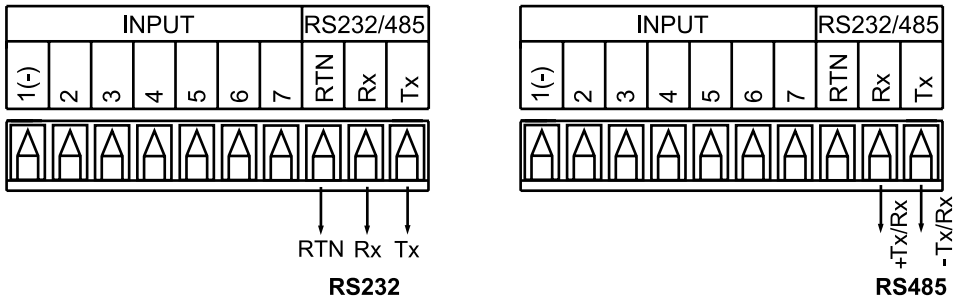

**Figure 2.10**

**a) Mechanical Relay and SSR Outputs Wiring Hookup**

**b) Pulse Outputs Wiring Hookup**

This device may have a programmable communication output. The RS-232 and RS-485 Output Connection are shown below.



**Figure 2.11**  
**a) RS-232 Output Wiring Hookup    b) RS-485 Output Wiring Hookup**

This meter is capable of supplying 5 or 10 Vdc sensor excitation. The excitation output connection and location of S2 pin selection jumper are shown below.

**Note** Excitation is not available if Serial Communication (-C24) or Ethernet (-C4EI) or Low Voltage Power Supply (-DC) options are installed.

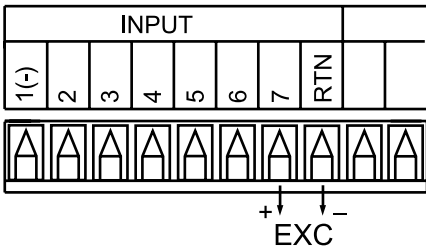

**Figure 2.12**  
**a) Excitation Output**

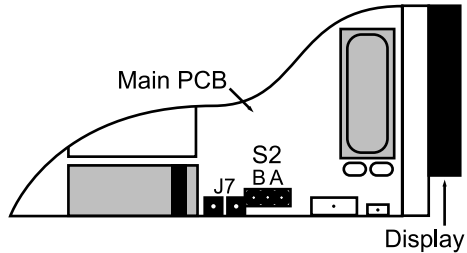

**b) Top View Location of S2**

Install jumpers according to the table below.

**Table 2.4 Jumper Connections**

Excitation Output	S2	
	A	B
10 V	Close	Open
5 V	Open	Close

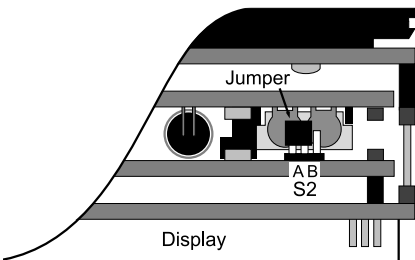

**c) Top View Location of S2 on 1/8 DIN Compact Unit**

**Note** Factory default is 10 V.

## PART 3

# OPERATION: CONFIGURATION MODE

## 3.1 Introduction

The instrument has two different modes of operation. The first, Run Mode, is used to display values for the Process Variable, and to display or clear Peak and Valley values. The other mode, Menu Configuration Mode, is used to navigate through the menu options and configure the controller. Part 3 of this manual will explain the Menu Configuration Mode. For your instrument to operate properly, the user must first "program" or configure the menu options.

### Turning your Device On for the First Time



















The device becomes active as soon as it is connected to a power source. It has no On or Off switch. The device at first momentarily shows the software version number, followed by reset **RSR**, and then proceeds to the Run Mode.

**Tip** 

For first-time users: Refer to the QuickStart Manual for basic operation and set-up instructions.

If you have the Serial Communications/Ethernet Option you can easily configure the controller on your computer or on-line.

**Table 3.1 Button Function in Configuration Mode**

 MENU	<ul style="list-style-type: none"><li>• To enter the Menu, the user must first press  button.</li><li>• Use this button to advance/navigate to the next menu item. The user can navigate through all the top level menus by pressing .</li><li>• While a parameter is being modified, press  to escape without saving the parameter.</li></ul>
 PK/GRS (UP)	<ul style="list-style-type: none"><li>• Press the up  button to scroll through "flashing" selections. When a numerical value is displayed press this key to increase value of a parameter that is currently being modified.</li><li>• Holding the  button down for approximately 3 seconds will speed up the rate at which the set point value increments.</li><li>• In the Run Mode press  causes the display to flash the PEAK or GROSS value – press again to return to the Run Mode.</li></ul>
 TARE (DOWN)	<ul style="list-style-type: none"><li>• Press the down  button to go back to a previous Top Level Menu item.</li><li>• Press this button twice to reset the instrument to the Run Mode.</li><li>• When a numerical value is flashing (except set point value) press  to scroll digits from left to right allowing the user to select the desired digit to modify.</li><li>• When a setpoint value is displayed press  to decrease value of a setpoint that is currently being modified. Holding the  button down for approximately 3 seconds will speed up the rate at which the setpoint value is decremented.</li><li>• In the Run Mode press  causes the display to flash the TARE value to tare your reading (zeroing). Press again to return to the Run Mode.</li></ul>
 ENTER	<ul style="list-style-type: none"><li>• Press the enter  button to access the submenus from a Top Level Menu item.</li><li>• Press  to store a submenu selection or after entering a value — the display will flash a <b>SEt</b> message to confirm your selection.</li><li>• To reset flashing Peak or Valley press .</li><li>• In the Run Mode, press  twice to enable Standby Mode with flashing <b>Stby</b>.</li></ul>

**Note** 

**Reset:** Except for Alarms, modifying any settings of the menu configuration will reset the instrument prior to resuming Run Mode.



### 3.2 Menu Configuration

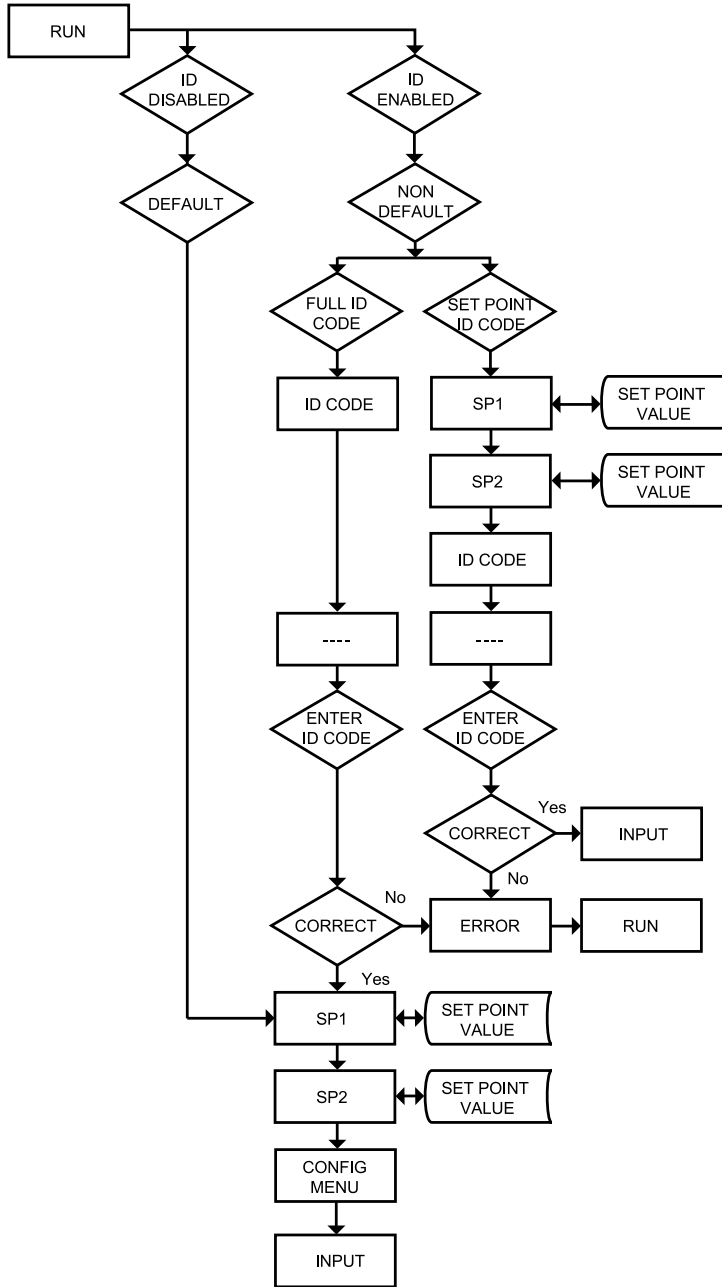

Figure 3.1 Flow Chart for ID and Set Points Menu

### 3.2.1 ID Number Menu









#### SEE ID MENU SELECTION IN CONFIGURATION SECTION FOR ENABLE/DISABLE OR CHANGE ID CODE.

**Note** ESP If ID Code is **Disabled** or set as **Default** (0000) the menu will skip ID step to Set Point Menu.

If ID Code is set to **Full Security Level** and user attempts to enter the Main Menu, they will be prompted for an ID Code.









If ID Code is set to **Setpoint/ID Security Level** and user attempts to enter the Configuration Menu, they will be prompted for an ID Code.

#### ENTERING YOUR NON-DEFAULT FULL SECURITY ID NUMBER.

- Press  1) Display shows **ID**.
- Press  2) Display advances to **----**.
- Press  &  3) Press  to increase digit 0-9. Press  to activate next digit (flashing). Continue to use  and  to enter your 4-digit ID Code.
- Press  4) If the correct ID Code is entered, the menu will advance to the Setpoint 1 Menu, otherwise an error message **ERR** will be displayed and the instrument will return to the Run Mode.

**Note** ESP To change ID Code, see ID Menu in the Configuration section.

#### ENTERING YOUR NON-DEFAULT SETPOINT/ID SECURITY ID NUMBER.







- Press  5) Display shows **SP1** Setpoint 1 Menu.
- Press  6) Display shows **SP2** Setpoint 2 Menu.
- Press  7) Display shows **ID** ID Code Menu.
- Press  8) Display advances to **----**.
- Press  &  9) Use  and  to change your ID Code.
- Press  10) If correct ID Code is entered, the display will advance to the **INPE** Input Menu, otherwise the error message **ERR** will be displayed and the monitor will return to the Run Mode.



**Note** ESP To prevent unauthorized tampering with the setup parameters, the instrument provides protection by requiring the user to enter the ID Code before allowing access to subsequent menus. If the ID Code entered does not match the ID Code stored, the monitor responds with an error message and access to subsequent menus will be denied.







**Tip** ESP Use numbers that are easy for you to remember. If the ID Code is forgotten or lost, call customer service with your serial number to access and reset the default to **0000**.

## 3.2.2 Set Points Menu





### SETPOINT 1:



- Press  1) Press , if necessary until **SP 1** prompt appears.
- Press  2) Display shows previous value of "Setpoint 1" with 1<sup>st</sup> digit flashing.
- Press  &  3) Press  and  to increase or decrease Setpoint 1 respectively.



 **Note** Holding  &  buttons down for approximately 3 seconds will speed up the rate at which the set point value increments or decrements.

- Press  &  4) Continue to use  and  to enter your 4-digit Setpoint 1 value.
- Press  5) Display shows **SEt R d** stored message momentarily and then advance to **SP 2** only, if a change was made, otherwise press  to advance to **SP 2** Setpoint 2 Menu.

### SETPOINT 2:

- Press  6) Display shows previous value of "Setpoint 2" with 1<sup>st</sup> digit flashing.
- Press  &  7) Press  and  to increase or decrease Setpoint 2 respectively.

 **Note** Holding  &  buttons down for approximately 3 seconds will speed up the rate at which the setpoint value increments or decrements.

- Press  8) Display shows **SEt R d** stored message momentarily and then advances to **ENFG** only, if a change was made, otherwise press  to advance to **ENFG** Configuration Menu.

### 3.2.3 Configuration Menu

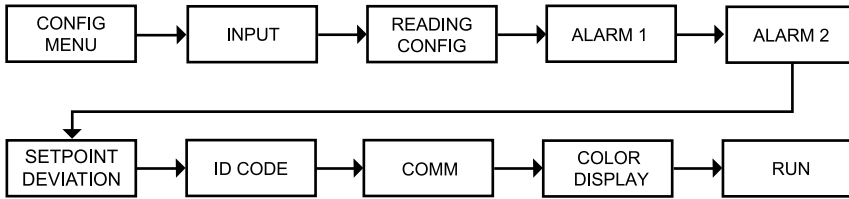
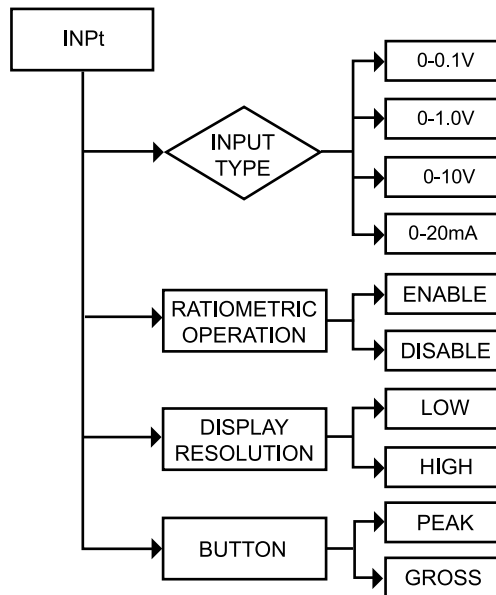

**Figure 3.2 Flow Chart for Configuration Menu**

#### Enter Configuration Menu:





- Press 1) Press , if necessary, until **ENFG** prompt appear.  
 Press 2) Display advance to **INPE** Input Menu.  
 Press 3) Press and release to scroll through all available menus of Configuration section.

### 3.2.4 Input Type Menu





**Figure 3.3 Flow Chart for Input Type Menu**

## ENTER INPUT TYPE MENU:

- Press  1) Press , if necessary, until **CONF** prompt appears.
- Press  2) Display advances to **INPT** Input Menu.
- Press  3) Display flashes **0-0.1**, **0-1.0**, **0-10** or **0-20** (0 to 100 mV, 0 to 1 V, 0 to 10 V or 0 to 20 mA).



## INPUT TYPE MENU:

- Press  4) Scroll through the available selection of input ranges **0-0.1**, **0-1.0**, **0-10** or **0-20** to the selection of your choice.
- Press  5) Display shows **SErD** stored message momentarily and then advances to the **RErD** Ratiometric operation submenu.

Input Types:      100 mV   1 V      10 V      0 – 20 mA  
Display:            **0-0.1**   **0-1.0**   **0-10**   **0-20**

**Note**  To have  $\pm 100$  mV you need to connect to 0-1 V.



## RATIOMETRIC OPERATION SUBMENU:

- Press  6) Display flashes previous selection of **ENbL** Enable or **dsbL** Disable.
- Press  7) Scroll through the available selection **ENbL** or **dsbL** (flashing).
- Press  8) Display shows **SErD** stored message momentarily and then advances to **RES0** Display Resolution Submenu.

**Note**  The Ratiometric operations are typically used for Strain gauge monitor. If your instrument is configured as Process (voltage and current), set **RErD** to **dsbL** disable Ratiometric operations.

**Note**  If **ENbL** Ratiometric operations **Enabled** was selected, the changes to the excitation voltage will be compensated through Ratio measurement. If **dsbL** Ratiometric operation **Disabled** was selected, any changes to the excitation voltage will effect the output of strain gauge bridge and, as a result, a reading of the instrument.

## DISPLAY RESOLUTION SUBMENU:

- Press  9) Display flashes previous selection of **L0** Low or **H1** High resolution.
- Press  10) Scroll through the available selection **L0** or **H1** (flashing).
- Press  11) Display shows **SErD** stored message momentarily and then advances to **buEN** Button Selection Submenu.

**Note**  If **L0** Low Resolution was selected the resolution of the display is 10  $\mu$ V. If **H1** High Resolution was selected the resolution of the display is 1  $\mu$ V. In case of High Resolution, the maximum input signal is 10 mV.

## BUTTON SELECTION SUBMENU:

- Press **↻**      **12)** Display flashes previous selection of **GROSS** Gross or **PEAK** Peak.
- Press **⬆**      **13)** Scroll through the available selection **GROSS** or **PEAK** to the selection of your choice.
- Press **↻**      **14)** Display shows **SEPa** stored message momentarily and then advances to **RdC** Reading Configuration Menu.

**Note** If **GROSS** was selected, in the Run Mode pressing **⬆** button causes the display to flash Gross value (value measured without zeroing of the display).  
 If **PEAK** was selected, in the Run Mode pressing **⬆** button causes the display to flash Peak value.



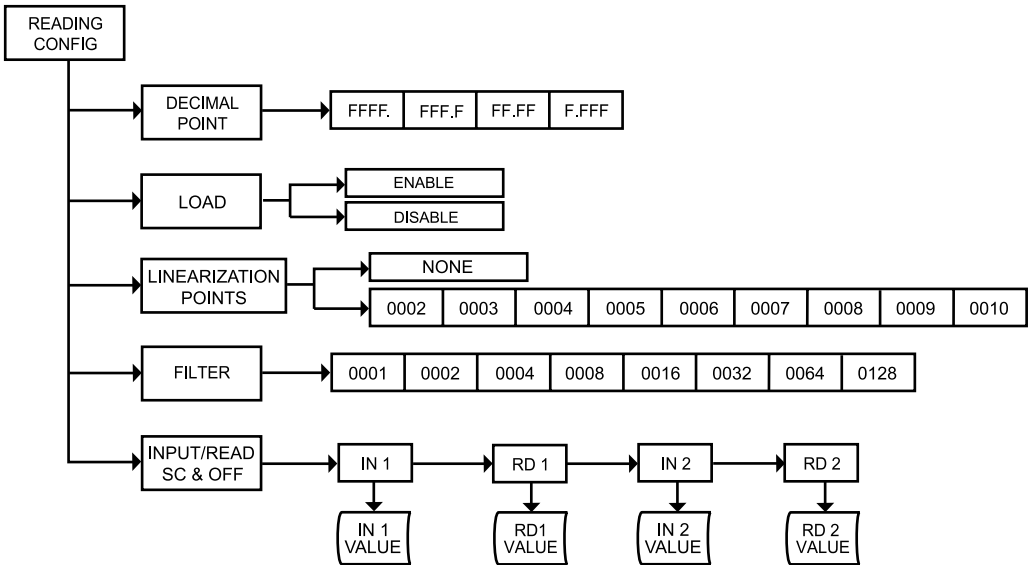

**Note** 0 - 20 mA current input used for process measurement only. For 4 - 20 mA Input select 0 - 20 mA and adjust the Input/Reading accordingly. To adjust 4 - 20 mA input, see example under INPUT/READING Submenu.

### 3.2.5 Reading Configuration Menu







**Figure 3.4 Flow Chart for Reading Configuration Menu**

## ENTER READING CONFIGURATION MENU:

- Press  1) Press , if necessary, until **ENFG** prompt appears.
- Press  2) Display advances to **INPE** Input Menu.
- Press  3) Display advances to **RdG** Reading Configuration Menu.
- Press  4) Display advances to **DEC** Decimal Point.



## DECIMAL POINT SUBMENU:

- Press  5) Display flashes previous selection for Decimal location.
- Press  6) Scroll through the available selections and choose Decimal location: **FFFF**, **FFF.F**, **FF.FF** or **F.FFF**
- Press  7) Display shows **SEEd** stored message momentarily only, if changes were made, otherwise press  to advance to **LOAD** Known/Unknown Loads Submenu.

**Note** 

Decimal Point is passive.



## KNOWN/UNKNOWN LOADS SUBMENU:

- Press  8) Display flashes previous selection of **ENbL** Enable or **dsbL** Disable.
- Press  9) Scroll through the available selection of **ENbL** or **dsbL** (flashing).
- Press  10) Display shows **SEEd** stored message momentarily and then advances to **L.PNE** Linearization Points Submenu.

**Note** 



If **ENbL** Known Loads scaling method was selected, calculate the input values to the instrument based on the actual signal being received. If **dsbL** Without Known Loads scaling method was selected, calculate input values to the instrument based on the transducer specification.

## LINEARIZATION POINTS SUBMENU:

- Press  11) Display flashes previous selection of Linearization Points Submenu.
- Press  12) Scroll through the available selections: **0002**, **0003**, **0004**, **0005**, **0006**, **0007**, **0008**, **0009**, **0010** - up to 10 Linearization Points can be selected. Default is **0002**.





**Note** 

If display flashes **NONE**, your instrument has only 2 linearization points.

- Press  13) Display shows **SEEd** stored message momentarily only, if a change was made, otherwise press  to advance to the **FLER** Filter Constant Submenu.

Linearization Points allow users to customize the Transducer curve.

## FILTER CONSTANT SUBMENU:

- Press  14) Display flashes previous selection for Filter Constant.
- Press  15) Scroll through the available selections: **0001**, **0002**, **0004**, **0008**, **0016**, **0032**, **0064**, **0128**. - Default is **0004**
- Press  16) Display shows **5tRd** stored message momentarily only, if a change was made, otherwise press  to advance to **IN.Rd** Input/Reading Submenu.

The Filter Constant Submenu allows the user to specify the number of readings stored in the Digital Averaging Filter.



For PID control select filter value 0001-0004. A filter value of 2 is approximately equal to 1 second RC low pass time constant.



### 3.2.6 Input/Reading (Scale and Offset) Menu

Input voltage or current can be converted or scaled into values appropriate for the process or signal being measured. So, a reading may be displayed, for example, in units of weight or velocity instead of in amperes and volts.

The instrument determines scale and offset values based on two user-provided input values entered with the corresponding readings.

There are two methods to scale this meter to display readings in engineering units. The **first** method is to scale with known loads. Do this by applying known loads to a transducer connected to a meter, or by simulating the output of the transducer with voltage or current simulator.

The **second** method is to scale without known inputs. Do this by calculating input values based on transducer specifications and manually entering them through the front panel push-buttons.

#### Example 1: Scaling with Known Loads (On-Line Calibration).

**Note** ESP When entering the input or reading values, disregard the position of the decimal point.

**Note** ESP If **ENBL** Enabled Load Submenu was selected, instrument is ready for scaling with Known Loads method.

Apply a known load equal to approximately 0% of the transducer range.

- Press **↻** 17) Press **↻** at the **IN 1** prompt. Display shows **IN 1** Input 1 Submenu.
- Press **↻** 18) Display shows the actual signal being received.
- Press **↻** 19) Display advances to **RD 1** Reading 1 Submenu.
- Press **↻** 20) Display shows last stored Reading 1 value with 1<sup>st</sup> digit flashing.
- Press **▲ & ▼** 21) Use **▲** and **▼** buttons to enter **RD 1** value.  
This value corresponds to Input 1 in terms of some meaningful engineering units. To show Input 1 as zero percent enter **RD 1** value = 0000.

- Press **↻** 22) Display shows **IN 2** Input 2 Submenu.

Apply a known load equal to approximately 100% of the transducer range.

- Press **↻** 23) Display shows the actual signal being received.
- Press **↻** 24) Display advances to **RD 2** Reading 2 Submenu.
- Press **↻** 25) Display shows last stored Reading 1 value with 1<sup>st</sup> digit flashing.
- Press **▲ & ▼** 26) Use **▲** and **▼** buttons to enter **RD 2** value.  
This value corresponds to Input 2 in terms of some meaningful engineering units. To show Input 2 as 100% enter **RD 2** value = 0100.

**Note** ESP This scaling method based on 2 input values entered with 2 corresponding reading. Up to 10 linearization points can be selected to customize the transducer curve. To select linearization points see "L.PNT" Submenu.

Note

Max scale should not be more than 50% FS because of noise related issues.

Press

27) Display flashes **S E R d** stored message momentarily and then advances to **AL R 1** only, if a change was made, otherwise advances to **AL R 1** Alarm 1 Menu.

### Example 2: Scaling without Known Loads.

Note

If **d S b L** Disabled **Load** Submenu was selected, instrument is ready for scaling Without Known Loads method.

To scale without known inputs, calculate inputs based on transducer specifications and manually enter them on the via front panel push-buttons. The following example assumes load cells with this specification:

Maximum Load: 100.0 lb  
 Output: 3.0 mV/V  
 Sensor Excitation 10 V  
 Maximum Sensor Output = 3.0 (mV/V) x 10 (V) = 30 mV

1. Determine the correct values for Inputs (**IN 1** and **IN 2**). Calculate **IN 1** and **IN 2** using the following equation:

$$IN = (\text{Sensor Output}) \times (\text{Conversion Number}) \times (\text{Multiplier})$$

Tip

Conversion number is a coefficient of conversion between input values and real full display range (10000 counts). See Table 3.2 below for proper conversion number.

Table 3.2 Conversion Table

INPUT RANGE	CONVERSION NUMBER
0 ~ 100 mV	10000 / (100 x 1) = 100 cts/mV
0 ~ 1 V	10000 / (1000 x 1) = 10 cts/mV
0 ~ 10 V	10000 / (1000 x 10) = 1 cts/mV
0 ~ 20 mA	10000 / (20 x 1) = 500 cts/mV

Example =  
 0 - 1 V = 0 - 100.0  
 In 1 = 0  
 Rd 1 = 0  
 Inp 2 = 9999  
 Rd 2 = 100.0

Tip

Multiplier determined by the Input Resolution setting (**RESO** in the **INPE** Menu). See Table 3.3 below for proper multiplier.

Table 3.3 Input Resolution Multiplier

INPUT RANGE	RESOLUTION	
	LOW	HIGH
0 ~ 100 mV	1.0	10.0
0 ~ 1 V	1.0	10.0
0 ~ 10 V	1.0	10.0
0 ~ 20 mA	1.0	10.0

Determine  $IN_1$  and  $IN_2$  Input Range and Resolution. For our transducer select 0 ~ 100 mV range and LOW resolution (10  $\mu$ V)

$$IN_1 = 0 \text{ (mV)} \times 100 \text{ (cts/mV)} \times 1.0 = 0$$
$$IN_2 = 30 \text{ (mV)} \times 100 \text{ (cts/mV)} \times 1.0 = 3000$$

2. Determine correct values for Display Reading ( $Rd_1$  and  $Rd_2$ ). In most cases,  $Rd_1$  and  $Rd_2$  are equal to the minimum and the maximum of the transducer output range.

$$Rd_1 = 0000$$
$$Rd_2 = 100.0$$

3. Scaling the controller.

- Press  $\rightarrow$  28) Press  $\rightarrow$  at the  $INRd$  prompt. Display shows  $IN_1$  Input 1 Submenu.
- Press  $\rightarrow$  29) Display shows last stored Input 1 value with 1<sup>st</sup> digit flashing.
- Press  $\uparrow$  &  $\downarrow$  30) Use  $\uparrow$  and  $\downarrow$  buttons to enter  $IN_1$  value (0000).
- Press  $\rightarrow$  31) Display advances to  $Rd_1$  only, if a change was made, otherwise press  $\rightarrow$  to advance to  $Rd_1$  Reading 1 Submenu.
- Press  $\rightarrow$  32) Display shows last stored Reading 1 value with 1<sup>st</sup> digit flashing.
- Press  $\uparrow$  &  $\downarrow$  33) Use  $\uparrow$  and  $\downarrow$  buttons to enter  $Rd_1$  value (0000).
- Press  $\rightarrow$  34) Display  $IN_2$  Input 2 Submenu.
- Press  $\rightarrow$  35) Display shows last stored Input 2 value with 1<sup>st</sup> digit flashing.
- Press  $\uparrow$  &  $\downarrow$  36) Use  $\uparrow$  and  $\downarrow$  buttons to enter  $IN_2$  value (3000).
- Press  $\rightarrow$  37) Display advances to  $Rd_2$  only, if a change was made, otherwise press  $\rightarrow$  to advance to  $Rd_2$  Reading 2 Submenu.
- Press  $\rightarrow$  38) Display shows last stored Reading 2 value with 1<sup>st</sup> digit flashing.
- Press  $\uparrow$  &  $\downarrow$  39) Use  $\uparrow$  and  $\downarrow$  buttons to enter  $Rd_2$  value (1000).
- Press  $\rightarrow$  40) Display flashes  $SEtRd$  stored message momentarily and then advances to  $ALR_1$  only, if a change was made, otherwise advances to  $ALR_1$  Alarm 1 Menu.

**Note**

This scaling method based on 2 input values entered with 2 corresponding reading. Up to 10 linearization points can be selected to customize the transducer curve. To select linearization points see "L.Pnt" Submenu.

### Example 3: Scaling with Current/Voltage Transducer (Process) Input.

The following example include details for a specific scenario in which a 4 - 20 mA input is to be represented as a measurement of 0 - 100 percent.

Press **↵** 41) Press **↵** at the **IN. Rd** prompt. Display shows **IN 1** Input 1 Submenu.

Press **↵** 42) Display shows Input 1 value with 1<sup>st</sup> digit flashing.

Press **▲ & ▼** 43) Use **▲** and **▼** buttons to enter **IN 1** value.

The **IN 1** value = min. input value x conversion number  
from Table 3.1

Enter 4 mA as 4 (mA) x 500 = 2000

Press **↵** 44) Display advances to **Rd 1** Reading 1 Submenu.

Press **▲ & ▼** 45) Use **▲** and **▼** buttons to enter **Rd 1** value.

This value corresponds to Input 1 in terms of some meaningful engineering units. To show 4 mA as zero percent enter **Rd 1** value = 0000.

Press **↵** 46) Display **IN 2** Input 2 Submenu.

Press **↵** 47) Display shows **IN 2** Input 2 value with 1<sup>st</sup> digit flashing.

The **IN 2** value = max. input value x conversion number  
from Table 3.1

Enter 20 mA as 20 (mA) x 500 = 10000 (entered as 9999)

Press **▲ & ▼** 48) Use **▲** and **▼** buttons to enter **IN 2** value.

Press **↵** 49) Display advances to **Rd 2** Reading 2 Submenu.

Press **▲ & ▼** 50) Use **▲** and **▼** buttons to enter **Rd 2** value.

To show 20 mA as 100 percent enter **Rd 2** value = 0100

Press **↵** 51) Display flashes **SE Rd** stored message momentarily and then advances to **ALR 1** only, if a change was made, otherwise advances to **ALR 1** Alarm 1 Menu.

### 3.2.7 Alarm 1 Menu

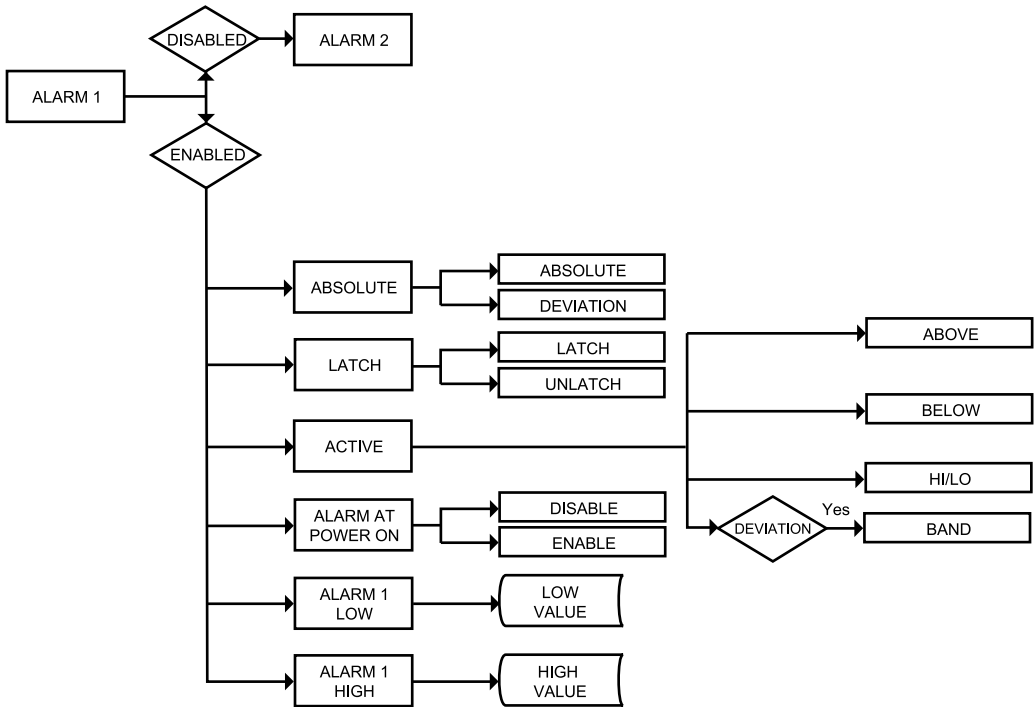

Figure 3.5 Flow Chart for Alarm 1 Menu

#### ENTER ALARM 1 MENU:

- Press 1) Press , if necessary, until **CONF** prompt appears.
- Press 2) Display advances to **INPE** Input Menu.
- Press 3) Press , if necessary, until Display advances to **ALR 1** Alarm 1 Menu.
- Press 4) Display advances to Alarm 1 **ENBL** Enable or **DSBL** Disable Submenu and flashes the previous selection.

## ALARM 1 ENABLE/DISABLE SUBMENU:

- Press ▲ 5) Scroll through the available selection until **ENBL** displays to use Alarm 1.
- Press ⌂ 6) Display shows **SETRd** stored message momentarily and then advances to **ABSa** only if it was changed, otherwise press ⌂ to advance to **ABSa** Alarm 1 Absolute/Deviation Submenu.



If **dsbl** Alarm 1 **Disabled** was selected, all submenus of Alarm 1 Menu will be skipped and meter advances to **ALR2** Alarm 2 Menu.

## ALARM 1 ABSOLUTE/DEVIATION SUBMENU:

- Press ⌂ 7) Display flashes previous selection. Press ▲ to **ABSa** Absolute or **DEVd** Deviation.
- Press ⌂ 8) Display shows **SETRd** stored message momentarily and then advances to **Ltch** only if it was changed, otherwise press ⌂ to advance to **Ltch** Alarm 1 Latch/Unlatch Submenu.

**Absolute Mode** allows Alarm 1 to function independently from Setpoint 1. If the process being monitored does not change often, then "Absolute" Mode is recommended.

**Deviation Mode** allows changes to Setpoint 1 to be made automatically to Alarm 1. Deviation Mode is typically the ideal mode if the process value changes often. In Deviation Mode, set Alarm 1 a certain number of degrees or counts away from Setpoint 1 — this relation remains fixed even if Setpoint 1 is changed.

## ALARM 1 LATCH/UNLATCH SUBMENU:

- Press ⌂ 9) Display flashes previous selection. Press ▲ to **Ltch** Latched or **UNLE** Unlatched.
- Press ⌂ 10) Display shows **SETRd** stored message momentarily and then advances to **ACTN** only, if it was changed, otherwise press ⌂ to advance to **ACTN** Active Submenu.

**Latched Mode:** Alarm remains "latched" until reset. To reset already latched alarm, select Alarm Latch and press ▲ twice (i.e. Unlatch and then back to Latch).

**Unlatched Mode:** Alarm remains latched only as long as the alarm condition is true.

## ACTIVE SUBMENU:

- Press **⏪** 13) Display flashes previous selection. Press **⏩** to scroll through the available selections: **AbOv** Above, **bELo** Below, **HiLo** HI/Low and **bAND** Band. (Band is active if **LDEN** Deviation was selected).
- Press **⏪** 14) Display shows **SEtP** stored message momentarily and then advances to **R.P.oN** only if it was changed, otherwise press **⏪** to advance to **R.P.oN** Alarm Enable/Disable at Power On Submenu.

**Above:** Alarm 1 condition triggered when the process variable is greater than the Alarm Hi Value (Low value ignored).

**Below:** Alarm 1 condition triggered when the process variable is less than the Alarm Low Value (Hi value ignored).

**Hi/Low:** Alarm 1 condition triggered when the process variable is less than the Alarm Low Value or above the Hi Value.

**Band:** Alarm 1 condition triggered when the process variable is above or below the "band" set around Setpoint 1. Band equals Hi Value (Low Value ignored). A "band" is set around the set point by the instrument only in the "Deviation" Mode.

The Band for the AL 1 would be following the Setpoint 1 value

The Band for the AL 2 would be following the Setpoint 2 value.

The Band or the Deviation Value should be entered under:

AL1 High (if they want Alarm 1)

AL2 High (if they want Alarm 2)

AL Low value is ignored in the Band mode.

**Example:** if customer requires a Deviation Value of  $\pm 10$  degrees around a setpoint (using Output 2 as alarm)





Alarm 2: - Deviation

Contact Closure type: Deviation---Band

AL2 High: 10 (Band they want around Setpoint 2)

Then the Band Value is to be entered under AL2 HI: 10 not  $80+10 = 90$









## ALARM ENABLE/DISABLE AT POWER ON:

- Press  15) Display flashes previous selection. Press  to **ENBL** enable or **DSBL** disable.
- Press  16) Display shows **SEtP** stored message momentarily and then advances to **ALR.L** only if it was changed, otherwise press  to advance to the **ALR.L** Alarm 1 Low Value Submenu.









### Note

If the alarm is enabled at Power On, the alarm will be active right after reset. If the alarm is disabled at Power On, the alarm will become enabled when the Process Value enters the non alarm area. The alarm is not active while the Process Value is approaching Setpoint 1.

## ALARM 1 LOW VALUE SUBMENU:

- Press  17) Display flashes 1<sup>st</sup> digit of previous value. Use  and  to enter new value.
- Press  &  18) Use  and  to enter Alarm 1 Low Value.
- Press  19) Display shows **SEtP** storage message momentarily and then advances to **ALR.H** only, if it was changed, otherwise press  to advance to **ALR.H** Alarm 1 HI Value Submenu.

## ALARM 1 HI VALUE SUBMENU:

- Press  20) Display flashes 1<sup>st</sup> digit of previous value. Use  and  to enter new value.
- Press  &  21) Use  and  to enter Alarm1 HI Value.
- Press  22) Display shows **SEtP** stored message momentarily and then advances to the next menu only, if it was changed, otherwise press  to advance to the next menu.

### Note

If the input wires of the meter get disconnected or broken, it will display **+ OL** Input (+) Overload message. For safety purposes you can set up your alarm to be triggered when input is open.



### 3.2.8 Alarm 2 Menu

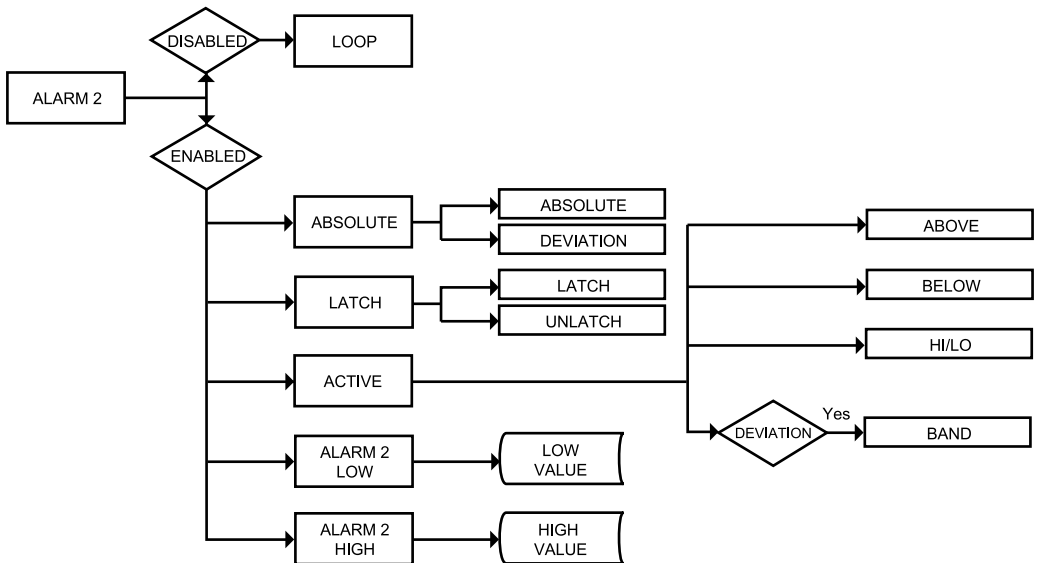

Figure 3.6 Flow Chart for Alarm 2 Menu

#### ENTER ALARM 2 MENU:

- Press **⏏** 1) Press **⏏**, if necessary, until **ENFG** prompt appears.
- Press **⏏** 2) Display advances to **INPE** Input Menu.
- Press **⏏** 3) Press **⏏**, if necessary, until display advances to **ALR2** Alarm 2 Menu.
- Press **⏏** 4) Display advances to Alarm 2 **ENBL** Enable or **DSBL** Disable Submenu.

#### ALARM 2 ENABLE/DISABLE SUBMENU:

- Press **⏏** 5) Display flashes previous selection. Press **⏏** until **ENBL** displays to use Alarm 2.
- Press **⏏** 6) Display shows **STRD** stored message momentarily and then advances to **ABS** only if it was changed, otherwise press **⏏** to advance to **ABS** Absolute/Deviation Submenu.

**Note** If **DSBL** Alarm 2 **Disabled** was selected, all submenus of Alarm 2 will be skipped and meter advances to **LOOP** Loop Break Time Menu.

**Note** The remaining Alarm 2 menu items are identical to Alarm 1 Menu. Modifying Alarm Settings will not reset the instrument.

### 3.2.9 Setpoint Deviation Menu

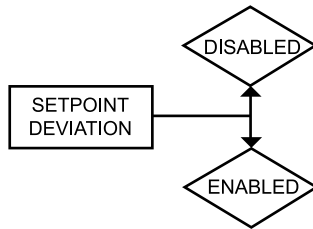

Figure 3.7 Flow Chart for Setpoint Deviation Menu

#### ENTER SETPOINT DEVIATION MENU:

- Press **⏏** 1) Press **⏏**, if necessary, until **ENFG** prompt appears.
- Press **⏏** 2) Display advances to **INPE** Input Menu.
- Press **⏏** 3) Press **⏏**, if necessary, until Display advances to **SP.dV** Setpoint Deviation Submenu.

#### SETPOINT DEVIATION ENABLE/DISABLE SUBMENU:

- Press **⏏** 13) Display advances to Setpoint Deviation **ENBL** Enable or **DSBL** Disable Submenu and flashes the previous selection.
- Press **⏏** 14) Scroll through the available selections: **ENBL** or **DSBL**.
- Press **⏏** 15) Display shows **SEPd** stored message momentarily and then advances to **OUT 1** Output 1 Menu.

**Set Point Deviation** Submenu, if “enabled”, allows changes to Setpoint 1 to be made automatically to Setpoint 2. This mode is very helpful if the Process Value changes often. In Set Point Deviation Mode, set SP2 a certain number of counts away from SP1 - this relation remains fixed when SP1 is changed. For instance: Setting SP1=200 and SP2=20 and enabling **SP.dV** means that the absolute value of SP2=220. Moving SP1 to 300, the absolute value of SP2 becomes 320.

### 3.2.10 ID Code Menu

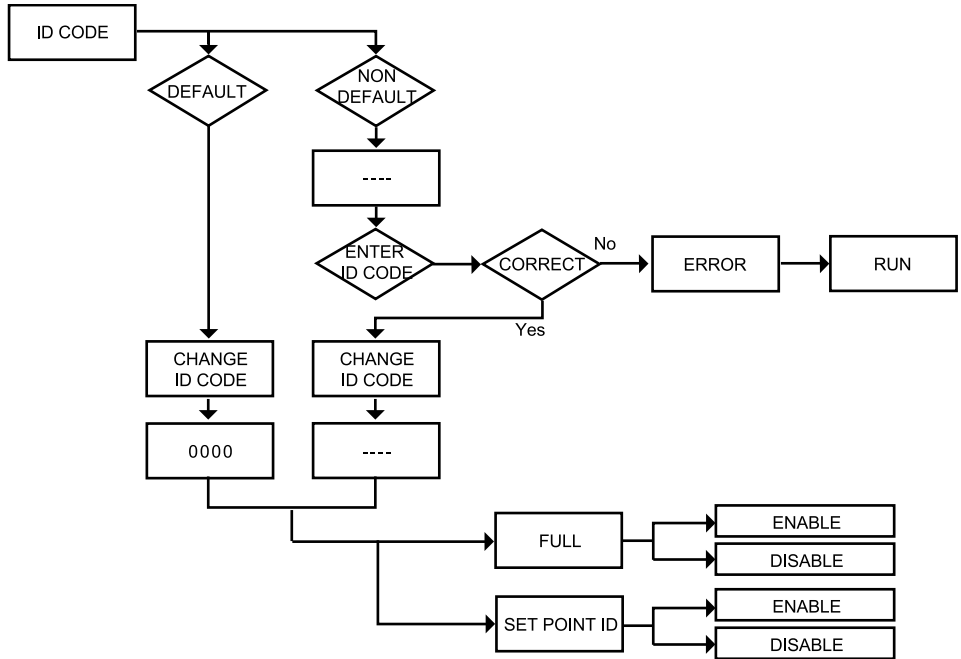

**Figure 3.8 Flow Chart for ID Code Menu**

#### ENTER ID CODE MENU:

- Press **⏪** 1) Press **⏪**, if necessary, until **CHFD** prompt appears.
- Press **⏩** 2) Display advances to **INPE** Input Menu.
- Press **⏪** 3) Press **⏪**, if necessary, until display advances to **ID** ID Code Menu.

#### ENTERING OR CHANGING YOUR (NON-DEFAULT) ID CODE:

- Press **⏩** 4) Display advances to **----** with 1<sup>st</sup> under score flashing.
- Press **⏮** & **⏭** 5) Press **⏮** and **⏭** to enter your 4-digit “ID Code” number.
- Press **⏩** 6) Display advances to **CH.ID** Change ID Code Submenu.

**Note** If entered “ID Code” is incorrect display shows **ERR** Error message momentarily and then skips to the Run Mode.

- Press **⏩** 7) Display flashes the first digit of previous entered “ID Code” number.
- Press **⏮** & **⏭** 8) Press **⏮** and **⏭** buttons to enter your new “ID Code” number.
- Press **⏩** 9) Display shows **STRD** stored message momentarily and then advances to the **FULL** Full Security Submenu.

## ENTERING OR CHANGING YOUR (DEFAULT) ID CODE:





**Note** 

Enter **ID** menu (Repeat steps from 1 to 3).

- Press  10) Display advances to **CH.ID** Change ID Code Submenu.  
Press  11) Display shows **0000** message with flashing 1<sup>st</sup> digit.

**Note** 

If you want to change your default "ID Code" you can do it now, otherwise press  and menu will skip to **FULL** Full Security Submenu.

- Press  &  12) Press  and  buttons to enter your new "ID Code" number.  
Press  13) Display shows **SEEd** stored message momentarily and then advances to the **FULL** Full Security Submenu.

## FULL SECURITY LEVEL SUBMENU:

- Press  14) Display flashes **ENbL** Enable or **DSbL** Disable.  
Press  15) Scroll through the available selections: "Enable" or "Disable".  
Press  16) Display shows **SEEd** stored message momentarily and then advances to **SP.ID** Setpoint/ID Submenu.

**Note** 

If "Full" Security Level is "Enabled" and the user attempts to enter the Main Menu, they will be prompted for an ID Code. The ID Code should be correct to enter the instrument Menu item.

## SETPOINT/ID SECURITY LEVEL SUBMENU:

This Security Level can be functional only if **FULL** Security Level is Disabled.

- Press  17) Display flashes **ENbL** Enable or **DSbL** Disable.  
Press  18) Scroll through the available selections: "Enable" or "Disable".  
Press  19) Display shows **SEEd** stored message momentarily and then advances to **COMM** Communication Submenu.

**Note** 

If "**Setpoint/ID**" Security Level is "**Enabled**" and the user attempts to advance into the **CONF** Configuration Menu, he will be prompted for ID Code number. The ID Code should be correct to proceed into the Configuration Menu, otherwise display will show an Error and skip to the Run Mode.

**Note** 

If "**Full**" and "**Setpoint/ID**" Security Levels are "**Disabled**", the ID code will be "Disabled" and user will not be asked for ID Code to enter the Menu items ("ID" Submenu will not show up in "ID/Setpoint" Menu).

### 3.2.11 Communication Option Menu

Purchasing the instrument with Serial Communications permits an instrument to be configured or monitored from an IBM PC compatible computer using software available from **the website listed on the cover page of this manual or on the CD-ROM enclosed with your shipment**. For complete instructions on the use of the Communications Option, refer to the Serial Communications Reference Manual.

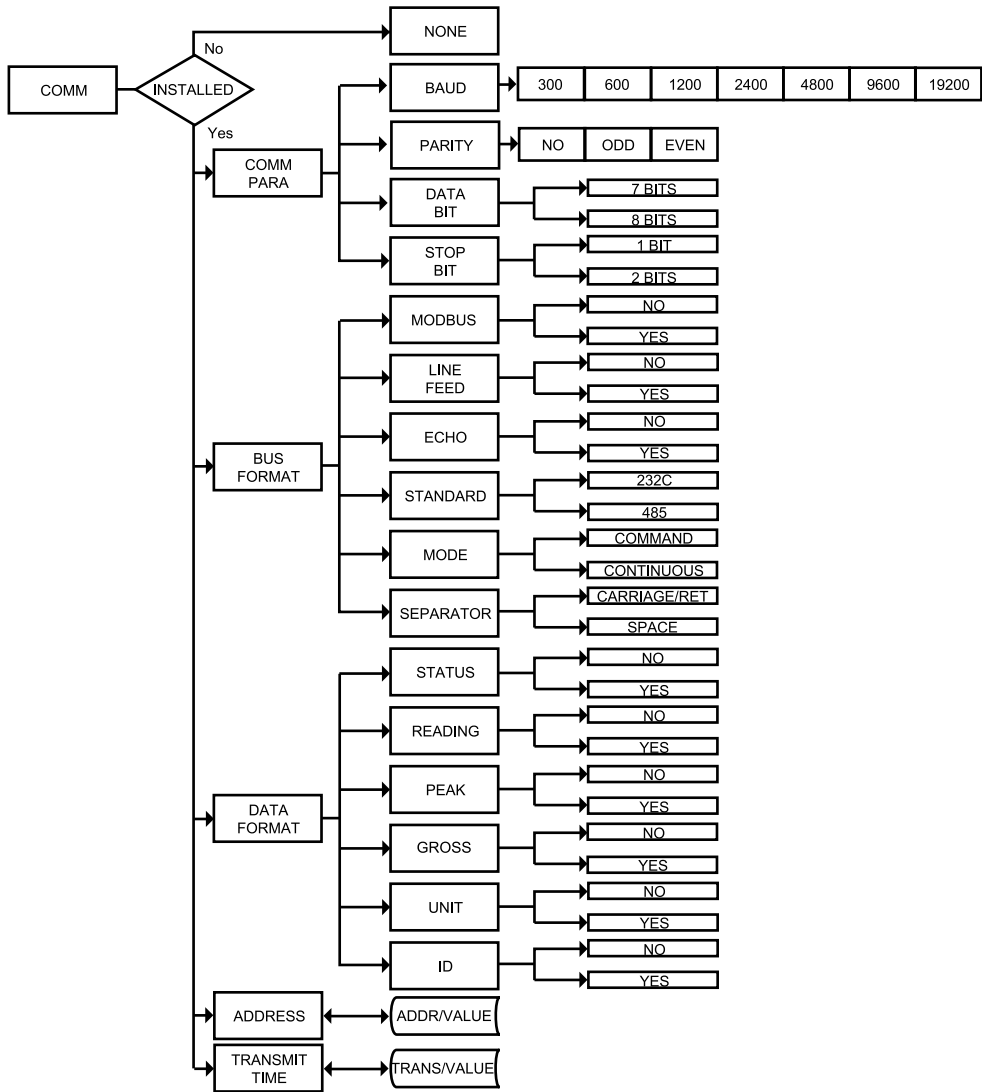







Figure 3.9 Flow Chart for Communication Option Menu

## ENTER COMMUNICATION OPTION MENU:

- Press  1) Press , if necessary, until **ENFC** prompt appears.
- Press  2) Display advances to **INPE** Input Menu.
- Press  3) Press , if necessary, until display advances to **COMM** Communication Options Menu.
- Press  4) Display advances to **CPAR** Communication Parameters Submenu.







If Communication Option is not installed, the display shows **NONE** and skips to the Color Display Menu.

## COMMUNICATION PARAMETERS SUBMENU:





Allows the user to adjust Serial Communications Settings of the instrument. When connecting an instrument to a computer or other device, the Communications Parameters must match. Generally the default settings (as shown in **Section 5**) should be utilized.

- Press  5) Display advances to **BAUD** Baud Submenu.





## BAUD SUBMENU:

- Press  6) Display flashes previous selection for **BAUD** value.
- Press  7) Scroll through the available selections: **300**, **600**, **1200**, **2400**, **4800**, **9600**, **19.2K**.
- Press  8) Display shows **SEED** stored message momentarily and then advances to **PREY** only, if it was changed, otherwise press  to advance to **PREY** Parity Submenu.





## PARITY SUBMENU:

- Press  9) Display flashes previous selection for "Parity".
- Press  10) Scroll through the available selections: NO, ODD, EVEN.
- Press  11) Display shows **SEED** stored message momentarily and then advances to **DATA** only, if it was changed, otherwise press  to advance to **DATA** Data Bit Submenu.

## DATA BIT SUBMENU:

- Press  12) Display flashes previous selection for "Data Bit".
- Press  13) Scroll through the available selections: 7-BIT, 8-BIT.
- Press  14) Display shows **SEED** stored message and then advances to **STOP** only, if it was changed, otherwise press  to advance to **STOP** Stop Bit Submenu.

## STOP BIT SUBMENU:





- Press  15) Display flashes previous selection for “Stop Bit”.
- Press  16) Scroll through the available selections: 1-BIT, 2-BIT.
- Press  17) Display shows **SEEd** stored message momentarily and then advances to **bUS.F** only, if it was changed, otherwise press  to advance to **bUS.F** Bus Format Submenu.

## BUS FORMAT SUBMENU:

Determines Communications Standards and Command/Data Formats for transferring information into and out of the monitor via the Serial Communications Bus. Bus Format submenus essentially determine how and when data can be accessed via the Serial Communications of the device.

- Press  18) Display advances to **m.bUS** Modbus Submenu.

## MODBUS PROTOCOL SUBMENU:

- Press  19) Display flashes previous selection for **m.bUS**.
- Press  20) Scroll through the available selections: NO, YES.
- Press  21) Display shows **SEEd** stored message momentarily and then advances to **-LF-** only, if it was changed, otherwise press  to advance to **-LF-** Line Feed submenu.





To select iSeries Protocol, set Modbus submenu to “No”.  
To select Modbus Protocol, set Modbus submenu to “Yes”.



If Modbus Protocol was selected, the following Communications Parameters must be set as: No Parity, 8-bit Data Bit, 1-Stop Bit. Do not attempt to change these parameters.





## LINE FEED SUBMENU:

Determines if data sent from the instrument will have a Line Feed appended to the end - useful for viewing or logging results on separate lines when displayed on communications software at a computer.

- Press  22) Display flashes previous selection for “Line Feed”.
- Press  23) Scroll through the available selections: NO, YES.
- Press  24) Display shows **SEEd** stored message momentarily and then advances to **ECHO** only, if it was changed, otherwise press  to advance to **ECHO** Echo Submenu.





## ECHO SUBMENU:

When valid commands are sent to the instrument, this determines whether the command will be echoed to the Serial Bus. Use of echo is recommended in most situations, especially to help verify that data was received and recognized by the monitor.

- Press  25) Display flashes previous selection for “Echo”.
- Press  26) Scroll through the available selections: NO, YES.
- Press  27) Display shows **SEEd** stored message momentarily and then advances to **SENd** only if it was changed, otherwise press  to advance to **SENd** Communication Standard Submenu.





## COMMUNICATION INTERFACE STANDARD SUBMENU:

Determines whether device should be connected to an RS-232C serial port (as is commonly used on IBM PC-compatible computers) or via an RS-485 bus connected through appropriate RS-232/485 converter. When used in RS-485 Mode, the device must be accessed with an appropriate Address Value as selected in the Address Submenu described later.

- Press  28) Display flashes previous selection for “Standard”.
- Press  29) Scroll through the available selections: 232C, 485.
- Press  30) Display shows **SEEd** stored message momentarily and then advances to **MoDE** only, if it was changed, otherwise press  to advance to **MoDE** Data Flow Mode Submenu.

## DATA FLOW MODE SUBMENU:





Determines whether the instrument will wait for commands and data requests from the Serial Bus or whether the instrument will send data automatically and continuously to the Serial Bus. Devices configured for the RS-485 Communications Standard operate properly only under Command Mode.

- Press  31) Display flashes previous selection for “Mode”.
- Press  32) Scroll through the available selections: **Cmd** “Command”, **CoNE** “Continuous”.
- Press  33) Display shows **SEEd** stored message momentarily and then advances to **SEPR** only, if it was changed, otherwise press  to advance to **SEPR** Data Separation Submenu.



## DATA SEPARATION CHARACTER SUBMENU:

Determines whether data sent from the device in Continuous Data Flow Mode will be separated by spaces or by Carriage Returns.

- Press  34) Display flashes previous selection for “Separation” Submenu.
- Press  35) Scroll through the available selections: **S P C E** “Space” or **\_ C R \_** “Carriage Return”.
- Press  36) Display shows **S E R d** stored message momentarily and then advances to **D A T E F** only, if it was changed, otherwise press  to advance to **D A T E F** Data Format Submenu.

## DATA FORMAT SUBMENU:





Preformatted data can be sent automatically or upon request from the monitor. Use the Data Format Submenus to determine what data will be sent in this preformatted data string. Refer to the iSeries Communications Manual for more information about the data format. At least one of the following suboptions must be enabled and hence output data to the Serial Bus.

 **Note** This menu is applicable for Continuous Mode of RS-232 communication.

- Press  37) Display advances to **S E A L E** Alarm Status Submenu.





## ALARM STATUS SUBMENU:

Includes Alarm Status bytes in the data string.

- Press  38) Display flashes previous selection for “Status” (alarm status).
- Press  39) Scroll through the available selections: NO, YES.
- Press  40) Display shows **S E R d** stored message momentarily and then advances to **R D N G** only, if it was changed, otherwise press  to advance to **R D N G** Reading Submenu.

## MAIN READING SUBMENU:

Includes Main Reading in the data string.

- Press  41) Display flashes previous selection for “Reading”.
- Press  42) Scroll through the available selections: NO, YES.
- Press  43) Display shows **S E R d** stored message momentarily and then advances to **P E A K** only, if it was changed, otherwise press  to advance to **P E A K** Peak Submenu.

## PEAK VALUE SUBMENU:

Includes Peak Value in the data string.

- Press **⏪** 44) Display flashes previous selection for **PEAK** Submenu.
- Press **⏩** 45) Scroll through the available selections: NO, YES.
- Press **⏪** 46) Display shows **SERd** stored message momentarily and then advances to **GROS** only, if it was changed, otherwise press **⏪** to advance to **GROS** Gross Submenu.

## GROSS VALUE SUBMENU:

Includes Gross Value in the data string.

- Press **⏪** 47) Display flashes previous selection for "Gross".
- Press **⏩** 48) Scroll through the available selections: NO, YES.
- Press **⏪** 49) Display shows **SERd** stored message momentarily and then advances to **UNIT** only, if it was changed, otherwise press **⏪** to advance to **UNIT** Unit Submenu.

## UNIT SUBMENU (not applicable):

- Press **⏪** 50) Display flashes previous selection for **UNIT**.
- Press **⏩** 51) Scroll through the available selections: NO, YES.
- Press **⏪** 52) Display shows **SERd** stored message momentarily and then advances to **ADDR** only, if it was changed, otherwise press **⏪** to advance to **ADDR** Address Setup Submenu.

## ADDRESS SETUP SUBMENU:

**Note** <sup>ESP</sup> This menu is applicable to the RS-485 Option only.

- Press **⏪** 53) Display advances to "Address Value" (0000 to 0199) Submenu.

## ADDRESS VALUE SUBMENU:

- Press **⏪** 54) Display flashes 1<sup>st</sup> digit of previously stored Address Value.
- Press **⏩** & **⏪** 55) Press **⏩** and **⏪** to enter new "Address Value".
- Press **⏪** 56) Display shows **SERd** stored message momentarily and then advances to **ER.TM** only, if it was changed, otherwise press **⏪** to advance to **ER.TM** Transmit Time Interval Submenu.

## TRANSMIT TIME INTERVAL SUBMENU:





This menu is applicable if “Continuous” Mode was selected in the “Data Flow Mode” Submenu and the device is configured as an RS-232C Standard device. Also, one or more options under the Data Format Submenu must be enabled.





Press  **57)** Display advances to “Transmit Time Value” Submenu.

## TRANSMIT TIME INTERVAL VALUE SUBMENU:

Determines the interval at which data will be emitted to the RS-232 Serial Bus when the instrument is in Continuous Data Flow Mode.

Press  **58)** Display flashes 1<sup>st</sup> digit of previous “Transmit Time Value” in seconds.

Press  &  **59)** Press  and  to enter new “Transmit Time Value”, e.g. 0030 will send the data every 30 seconds in Continuous Mode.

Press  **60)** Display shows  stored message momentarily and then advances to  only, if it was changed, otherwise press  to advance to  Color Display Selection Menu.



**For more details, refer to the Communication Manual available at the website listed on the cover page of this manual or on the CD-ROM enclosed with your shipment.**

### 3.2.12 Display Color Selection Menu

The menu below allows the user to select the color of the display.

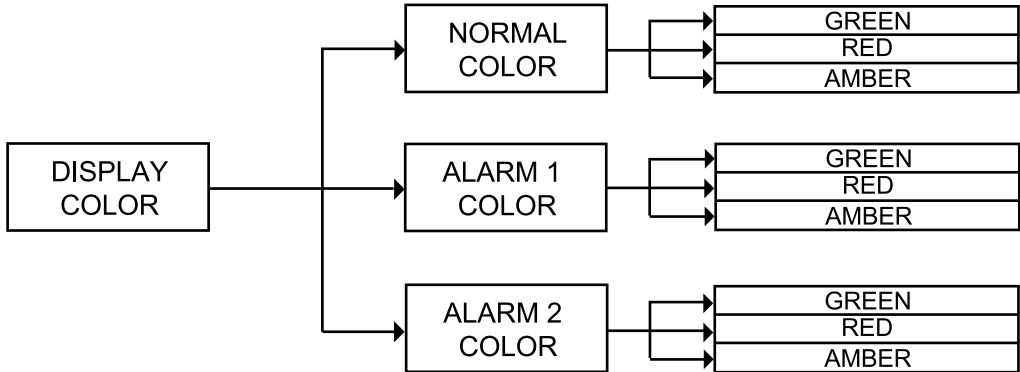

Figure 3.10 Flow Chart for Display Color Selection Menu

#### ENTER DISPLAY COLOR SELECTION MENU:

- Press **⏪** 1) Press **⏪**, if necessary, until **ENFC** prompt appears.
- Press **⏩** 2) Display advances to **INPE** Input Menu.
- Press **⏪** 3) Press **⏪**, if necessary, until Display advances to **COLR** Display Color Selection Menu.
- Press **⏩** 4) Display advances to **N.CLR** Normal Color Submenu.

#### NORMAL COLOR DISPLAY SUBMENU:



- Press **⏩** 5) Display flashes the previous selection for “Normal Color”.
- Press **⏴** 6) Scroll through the available selections: **GRN**, **RED** or **AMBR**.
- Press **⏩** 7) Display shows **SEEd** stored message momentarily and then advances to **1.CLR** only, if it was changed, otherwise press **⏩** to advance to **1.CLR** Alarm 1 Display Color Submenu.

The menu below allows the user to change the color of display when alarm is triggered.

#### ALARM 1 DISPLAY COLOR SUBMENU:

- Press **⏩** 8) Display flashes previous selection for “Alarm 1 Color Display”.
- Press **⏴** 9) Scroll through the available selections: **GRN**, **RED** or **AMBR**.
- Press **⏩** 10) Display shows **SEEd** stored message momentarily and then advances to **2.CLR** only, if it was changed, otherwise press **⏩** to advance to **2.CLR** Alarm 2 Display Color Submenu.

## ALARM 2 DISPLAY COLOR SUBMENU:

- Press  11) Display flashes previous selection for "Alarm 2 Color Display".  
 Press  12) Scroll through the available selections: **GRN**, **RED** or **AMBR**.  
 Press  13) Display shows **SEtRd** stored message momentarily and then momentarily shows the software version number, followed by **RSE** Reset, and then proceeds to the Run Mode.

**Tip**  IN ORDER TO DISPLAY ONE COLOR, SET THE SAME DISPLAY COLOR ON ALL THREE SUBMENUS ABOVE.

**Note**  If user wants the Display to change color every time that both Alarm 1 and Alarm 2 are triggered, the Alarm values should be set in such a way that Alarm 1 value is always on the top of Alarm 2 value, otherwise value of Alarm 1 will overwrite value of Alarm 2 and Display Color would not change when Alarm 2 is triggered.

### Example 1:

Alarm Setup: Absolute, Above, Alarm 2 HI Value "ALR.H" = 200,  
 Alarm 1 HI Value "ALR.H" = 400

Color Display Setup: Normal Color "N.CLR" = Green, Alarm 1 Color "1.CLR" = Amber, Alarm 2 Color "2.CLR" = Red

### Display Colors change sequences:

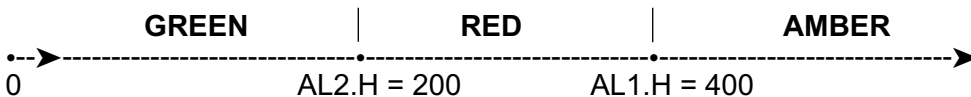

### Example 2:

Alarms Setup: Absolute, Below, Alarm 2 Low Value "ALR.L" = 300,  
 Alarm 1 Low Value "ALR.L" = 100

Color Display Setup: "N.CLR" = Green, "1.CLR" = Amber, "2.CLR" = Red

### Display Colors change sequences:

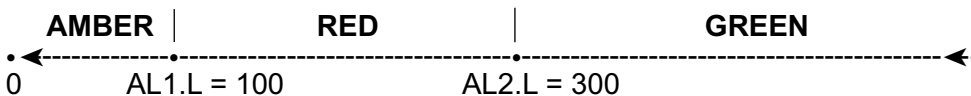

**Example 3:**

Setpoint 1: 200

Setpoint 2: 200

Alarm 1 & 2 Setup: Deviation, Band, "ALR.H" = 10

Color Display Setup: "N.CLR" = Green, "1.CLR" = Amber, "2.CLR" = Red

**Display Colors change sequences:**

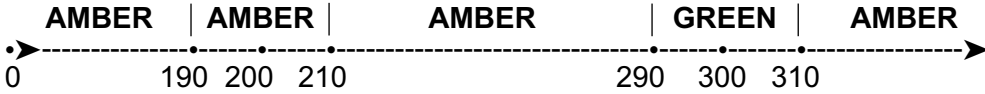

Alarm 1 is designed to monitor the Process Value around the Setpoint 1. Alarm 2 is designed to monitor the Process Value around the Setpoint 2.

**Example 4:**

Setpoint 1: 200

Setpoint 2: 200

Alarm 1 Setup: Deviation, Band, "ALR.H" = 20

Alarm 2 Setup: Deviation, Hi/Low, "ALR.H" = 10, "ALR.L" = 5

Color Display Setup: "N.CLR" = Green, "1.CLR" = Amber, "2.CLR" = Red

**Display colors change sequences:**

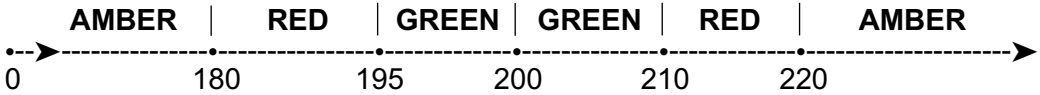

**Reset:** The instrument automatically resets after the last menu of the Configuration Mode has been entered. After the instrument resets, it advances to the Run Mode.

## **PART 4 SPECIFICATIONS**

### **Accuracy**

0.03% reading

### **Resolution**

10 / 1  $\mu$ V

### **Temperature Stability**

50 ppm/ $^{\circ}$ C

### **NMRR**

60 dB

### **CMRR**

120 dB

### **A/D Conversion**

Dual slope

### **Reading Rate**

3 samples per second

### **Digital Filter**

Programmable

### **Display**

Single 4-digit, 9-segment LED;  
• 10.2 mm (0.4" for i/32 and i/16),  
• 21 mm (0.83" for i/8);  
red, green and amber programmable  
colors for process variable and set  
points

### **Warm up to Rated Accuracy**

30 min.

## **INPUT**

### **Input Types**

Analog Voltage, Analog Current

### **Voltage Input**

0 to 100 mV

0 to 1 V ( $\pm$ 100 mV)

0 to 10 Vdc

### **Input Impedance:**

10 M $\Omega$  for 100 mV

1 M $\Omega$  for 1 V or 10 Vdc

### **Current Input**

0 to 20 mA (5 ohm load)

### **Linearization Points**

Up to 10 Linearization Points

## **Configuration**

Single-ended

### **Polarity**

Unipolar

### **Step Response**

0.7 sec for 99.9%

### **Decimal Selection**

None, 0.1, 0.01 or 0.001

### **Setpoint Adjustment**

-1999 to 9999 counts

### **Span Adjustment**

0.001 to 9999 counts

### **Offset Adjustment**

-1999 to +9999

## **NETWORK AND COMMUNICATIONS**

**(Optional -C24, -C4EI, -EI not  
available with excitation)**

**Ethernet:** Standards Compliance  
IEEE 802.3 10Base-T

**Supported Protocols:** TCP/IP, ARP,  
HTTPGET

### **RS-232/RS-422/RS-485/MODBUS:**

Selectable from menu; both ASCII  
and modbus protocol selectable from  
menu. Programmable 300 to 19.2 K  
baud; complete programmable setup  
capability; program to transmit current  
display, alarm status, min/max, actual  
measured input value and status.

### **RS-485**

Addressable from 0 to 199

### **Connection**

Screw terminals

## ALARM 1 & 2

Programmable to Display Color Change

### Relay\*

250 Vac or 30 Vdc @ 3 A  
(Resistive Load)

**Output 1\*:** SPDT type, can be configured as Alarm 1 output

**Output 2\*:** SPDT type, can be configured as Alarm 2 output

### SSR\*

20-265 Vac @ 0.05-0.5 A  
(Resistive Load); continuous

### DC Pulse\*

Non-Isolated; 10 Vdc @ 20 mA

\* Only with -AL Limit Alarm Option

### Operation

High/low, above/below, band, latch/unlatch, normally open/normally closed and process/deviation; front panel configurations

## EXCITATION

(optional in place of Communication)

5 Vdc @ 40 mA

10 Vdc @ 60 mA

Not available for Low Power Option

## INSULATION

### Power to Input/Output

2300 Vac per 1 min. test

1500 Vac per 1 min. test,  
(Low Voltage/Power Option)

### RS-232/485 to Inputs/Outputs

500 Vac per 1 min. test  
(no isolation is provided for Strain units)

### Approvals

UL, C-UL and see CE Approval Section

## GENERAL

### Line Voltage/Power

90-240 Vac +/-10%, 50-400 Hz\*

110-375 Vdc, equivalent voltage, **4 W**

\* No CE compliance above 60 Hz

## Low Voltage/Power Option

12-36 Vdc, **3 W\*\***

External power source must meet Safety Agency Approvals.

\*\* Units can be powered safely with 24 Vac but, No Certification for CE/UL are claimed.

## External Fuse Required

Time-Delay, UL 248-14 listed:

100 mA/250 V

400 mA/250 V (Low Voltage/Power Option)

Time-Lag, IEC 127-3 recognized:

100 mA/250 V

400 mA/250 V (Low Voltage/Power Option)

## Environmental Conditions

All models: 0 to 55°C (32 to 131°F),

90% RH non-condensing

iS8C models: 0 to 50°C (32 to 122°F)

for UL only. 90% RH non-condensing

## Protection

NEMA-4x/Type 4/IP65 front bezel

## Dimensions

i/8 Series: 48 H x 96 W x 127 mm D  
(1.89 x 3.78 x 5")

i/8 Compact Series:  
48 H x 96 W x 74 mm D  
(1.89 x 3.78 x 2.91")

i/16 Series: 48 H x 48 W x 127 mm D  
(1.89 x 1.89 x 5")

i/32 Series: 25.4 H x 48 W x 127 mm D  
(1.0 x 1.89 x 5")

## Panel Cutout

i/8 Series: 1/8 DIN

45 H x 92 W mm (1.772" x 3.622")

i/16 Series: 1/16 DIN  
45 mm (1.772") square

i/32 Series: 1/32 DIN  
22.5 H x 45 W mm (0.886" x 1.772")

## Weight

i/8 Series: 295 g (0.65 lb)

i/16 Series: 159 g (0.35 lb)

i/32 Series: 127 g (0.28 lb)



## PART 5 FACTORY PRESET VALUES

**Table 5.1 Factory preset value**

MENU ITEMS	FACTORY PRESET VALUES	NOTES
Set Point 1 (SP1)	000.0	
Set Point 2 (SP2)	000.0	
<b>Input:</b>		
Input Type (INPT)	0 TO 100 MV (0-0.1)	
Ratiometric Operation (RTIO)	Enable (ENBL)	
Display Resolution (RESO)	Low (LO)	
▲ Button	Peak (PEAK)	
<b>Reading Configuration (RDG):</b>		
Decimal Point (DEC.P)	FFF.F	
Linearization Points (L.PNT)	0002	
Filter Value (FLTR)	0004	
Input/Reading (IN.RD)	0-100 mV = 0-9999	
Scale and Offset		
<b>Alarm 1 &amp; 2:</b>		
Alarm 1 (ALR1), Alarm 2 (ALR2)	Disable (DSBL)	
Absolute/Deviation (ABSO/DEV)	Absolute (ABSO)	
Latch/Unlatch (LTCH/UNLT)	Unlatch (UNLT)	
Contact Closure (CT.CL)	Normally Open (N.O.)	
Active (ACTV)	Above (ABOV)	
Alarm At Power On (A.P.ON)	Disable (DSBL)	Alarm 1 only
Alarm Low (ALR.L)	-100.0	
Alarm High (ALR.H)	400.0	
<b>Setpoint Deviation:</b>		
Setpoint Deviation	Disable (DSBL)	
<b>ID:</b>		
ID Value	0000	
Full ID (FULL)	Disable (DSBL)	
Set Point ID (ID.SP)	Disable (DSBL)	

**Table 5.1 Factory preset value -- continued**

<b>MENU ITEMS</b>	<b>FACTORY PRESET VALUES</b>	<b>NOTES</b>
<b>Communication Parameters:</b>		
Baud Rate (BAUD)	9600	
Parity (PRTY)	Odd	
Data bit (DATA)	7 bit	
Stop Bit	1 bit	
Modbus Protocol (M.BUS)	No	
Line Feed (LF)	No	
Echo (ECHO)	Yes	
Standard Interface (STND)	RS-232 (232C)	
Command Mode (MODE)	Command (CMD)	
Separation (SEPR)	Space (SPCE)	
Alarm Status (STAT)	No	
Reading (RDNG)	Yes	
Peak	No	
Gross (GROS)	No	
Units (UNIT)	No	
Multipoint Address (ADDR)	0001	
Transmit Time (TR.TM)	0016	
<b>Display Color (COLR):</b>		
Normal Color (N.CLR)	Green (GRN)	
Alarm 1 Color (1.CLR)	Red (RED)	
Alarm 2 Color (2.CLR)	Amber (AMBR)	

## PART 6 CE APPROVALS INFORMATION

 This product conforms to the EMC directive 89/336/EEC amended by 93/68/EEC, and with the European Low Voltage Directive 72/23/EEC.

### Electrical Safety EN61010-1:2001

Safety requirements for electrical equipment for measurement, control and laboratory.

### Double Insulation

### Pollution Degree 2

### Dielectric withstand Test per 1 min

- Power to Input/Output: 2300Vac (3250Vdc)
- Power to Input/Output: 1500Vac (2120Vdc)  
(Low Voltage dc Power Option\*)
- Power to Relays/SSR Output: 2300Vac (3250Vdc)
- Ethernet to Inputs: 1500Vac (2120Vdc)
- Isolated RS232 to Inputs: 500Vac (720Vdc)
- Pulse to Inputs: No Isolation

### Measurement Category I

Category I are measurements performed on circuits not directly connected to the Mains Supply (power). Maximum Line-to-Neutral working voltage is 50Vac/dc. This unit should not be used in Measurement Categories II, III, IV.

### Transients Overvoltage Surge (1.2 / 50uS pulse)

- Input Power: 2500V
- Input Power: 1500V  
(Low Voltage dc Power Option\*)
- Ethernet: 1500V
- Input/Output Signals: 500V

**Note:** \*Units configured for external low power dc voltage, 12-36Vdc

### EMC EN61326:1997 + and A1:1998 + A2:2001

Immunity and Emissions requirements for electrical equipment for measurement, control and laboratory.

- EMC Emissions Table 4, Class B of EN61326
- EMC Immunity\*\* Table 1 of EN61326

**Note:** \*\*I/O signal and control lines require shielded cables and these cables must be located on conductive cable trays or in conduits. Furthermore, the length of these cables should not exceed 30 meters



Refer to the EMC and Safety installation considerations (Guidelines) of this manual for additional information.









## WARRANTY/DISCLAIMER

OMEGA ENGINEERING, INC. warrants this unit to be free of defects in materials and workmanship for a period of **one (1) year** from the date of purchase. In addition to OMEGA's standard warranty period, OMEGA Engineering will extend the warranty period for **four (4) additional years** if the warranty card enclosed with each instrument is returned to OMEGA.

If the unit malfunctions, it must be returned to the factory for evaluation. OMEGA's Customer Service Department will issue an Authorized Return (AR) number immediately upon phone or written request. Upon examination by OMEGA, if the unit is found to be defective, it will be repaired or replaced at no charge. OMEGA's WARRANTY does not apply to defects resulting from any action of the purchaser, including but not limited to mishandling, improper interfacing, operation outside of design limits, improper repair, or unauthorized modification. This WARRANTY is VOID if the unit shows evidence of having been tampered with or shows evidence of having been damaged as a result of excessive corrosion; or current, heat, moisture or vibration; improper specification; misapplication; misuse or other operating conditions outside of OMEGA's control. Components which wear are not warranted, including but not limited to contact points, fuses, and triacs.

OMEGA is pleased to offer suggestions on the use of its various products. However, OMEGA neither assumes responsibility for any omissions or errors nor assumes liability for any damages that result from the use of its products in accordance with information provided by OMEGA, either verbal or written. OMEGA warrants only that the parts manufactured by it will be as specified and free of defects. OMEGA MAKES NO OTHER WARRANTIES OR REPRESENTATIONS OF ANY KIND WHATSOEVER, EXPRESS OR IMPLIED, EXCEPT THAT OF TITLE, AND ALL IMPLIED WARRANTIES INCLUDING ANY WARRANTY OF MERCHANTABILITY AND FITNESS FOR A PARTICULAR PURPOSE ARE HEREBY DISCLAIMED. LIMITATION OF LIABILITY: The remedies of purchaser set forth herein are exclusive, and the total liability of OMEGA with respect to this order, whether based on contract, warranty, negligence, indemnification, strict liability or otherwise, shall not exceed the purchase price of the component upon which liability is based. In no event shall OMEGA be liable for consequential, incidental or special damages.

CONDITIONS: Equipment sold by OMEGA is not intended to be used, nor shall it be used: (1) as a "Basic Component" under 10 CFR 21 (NRC), used in or with any nuclear installation or activity; or (2) in medical applications or used on humans. Should any Product(s) be used in or with any nuclear installation or activity, medical application, used on humans, or misused in any way, OMEGA assumes no responsibility as set forth in our basic WARRANTY/DISCLAIMER language, and, additionally, purchaser will indemnify OMEGA and hold OMEGA harmless from any liability or damage whatsoever arising out of the use of the Product(s) in such a manner.

## RETURN REQUESTS/INQUIRIES

Direct all warranty and repair requests/inquiries to the OMEGA Customer Service Department. BEFORE RETURNING ANY PRODUCT(S) TO OMEGA, PURCHASER MUST OBTAIN AN AUTHORIZED RETURN (AR) NUMBER FROM OMEGA'S CUSTOMER SERVICE DEPARTMENT (IN ORDER TO AVOID PROCESSING DELAYS). The assigned AR number should then be marked on the outside of the return package and on any correspondence.

The purchaser is responsible for shipping charges, freight, insurance and proper packaging to prevent breakage in transit.

FOR WARRANTY RETURNS, please have the following information available BEFORE contacting OMEGA:

1. Purchase Order number under which the product was PURCHASED,
2. Model and serial number of the product under warranty, and
3. Repair instructions and/or specific problems relative to the product.

FOR NON-WARRANTY REPAIRS, consult OMEGA for current repair charges. Have the following information available BEFORE contacting OMEGA:

1. Purchase Order number to cover the COST of the repair,
2. Model and serial number of product, and
3. Repair instructions and/or specific problems relative to the product.

OMEGA's policy is to make running changes, not model changes, whenever an improvement is possible. This affords our customers the latest in technology and engineering.

© Copyright 2005 OMEGA ENGINEERING, INC. All rights reserved. This document may not be copied, photocopied, reproduced, translated, or reduced to any electronic medium or machine-readable form, in whole or in part, without the prior written consent of OMEGA ENGINEERING, INC.

**TRADEMARK NOTICE:** ®, *omega.com*®, OMEGA®, and are Trademarks of OMEGA ENGINEERING, INC.

**PATENT NOTICE:** This product is covered by one or more of the following patents: U.S. Pat. No. Des. 336,895; 5,274,577; 6,243,021 / CANADA 2052599; 2052600 / ITALY 1249456; 1250938 / FRANCE BREVET No. 91 12756 / SPAIN 2039150; 2048066 / UK PATENT No. GB2 249 837; GB2 248 954 / GERMANY DE 41 34398 C2. The "Meter Bezel Design" is a Trademark of NEWPORT Electronics, Inc. Used under License. Other US and International Patents pending or applied for.

# Where Do I Find Everything I Need for Process Measurement and Control? **OMEGA...Of Course!**

***Shop on line at [www.omega.com](http://www.omega.com)***

## **TEMPERATURE**

- Thermocouple, RTD & Thermistor Probes, Connectors, Panels & Assemblies
- Wire: Thermocouple, RTD & Thermistor
- Calibrators & Ice Point References
- Recorders, Controllers & Process Monitors
- Infrared Pyrometers

## **PRESSURE, STRAIN AND FORCE**

- Transducers & Strain Gauges
- Load Cells & Pressure Gauges
- Displacement Transducers
- Instrumentation & Accessories

## **FLOW/LEVEL**

- Rotameters, Gas Mass Flowmeters & Flow Computers
- Air Velocity Indicators
- Turbine/Paddlewheel Systems
- Totalizers & Batch Controllers

## **pH/CONDUCTIVITY**

- pH Electrodes, Testers & Accessories
- Benchtop/Laboratory Meters
- Controllers, Calibrators, Simulators & Pumps
- Industrial pH & Conductivity Equipment

## **DATA ACQUISITION**

- Data Acquisition & Engineering Software
- Communications-Based Acquisition Systems
- Plug-in Cards for Apple, IBM & Compatibles
- Datalogging Systems
- Recorders, Printers & Plotters

## **HEATERS**

- Heating Cable
- Cartridge & Strip Heaters
- Immersion & Band Heaters
- Flexible Heaters
- Laboratory Heaters

## **ENVIRONMENTAL MONITORING AND CONTROL**

- Metering & Control Instrumentation
- Refractometers
- Pumps & Tubing
- Air, Soil & Water Monitors
- Industrial Water & Wastewater Treatment
- pH, Conductivity & Dissolved Oxygen Instruments