

3 YEAR
WARRANTY

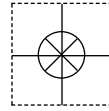

230 VAC Model
Only

CAUTION! – This product
is not intended for medical
use or use on humans



Ω OMEGA® User's Guide



Shop online at
omega.com®

e-mail: info@omega.com
For latest product manuals:
www.omegamanual.info

CL1000 SERIES

Mini hot point® Dry Block Probe Calibrator



omega.com info@omega.com

Servicing North America:

U.S.A.:

Toll-Free: 1-800-826-6342 (USA & Canada only)

Customer Service: 1-800-622-2378 (USA & Canada only)

Engineering Service: 1-800-872-9436 (USA & Canada only)

Tel: (203) 359-1660 Fax: (203) 359-7700

e-mail: info@omega.com

For Other Locations Visit omega.com/worldwide

Table of Contents

Section	Page
Section 1 Introduction	1-1
1.1 Precautions	1-1
1.2 Safety Warning	1-1
1.3 IEC Symbols	1-1
1.4 Statement on CE marking	1-2
1.5 General Description	1-2
1.6 Available Models	1-2
Section 2 Installation	2-1
2.1 Unpacking and Inspection	2-1
2.2 Mounting	2-1
2.3 Environmental Operating Conditions	2-1
2.3.1 Ambient Temperature Effects	2-1
2.3.2 Relative Humidity	2-2
2.4 Power Connection/Requirements	2-2
2.4.1 Standard (115 VAC~, 50/60 Hz Models)	2-3
2.4.2 International (230 VAC~, 50/60 Hz Models)	2-3
Section 3 Operation	3-1
3.1 Important Notes on Calibrator Operation	3-1
3.2 Front Panel Controls and Indicators	3-1
3.2.1 Process Temperature/Setpoint Temperature Display	3-1
3.2.2 Probe Well	3-1
3.2.3 Available Probe Well Styles	3-2
3.2.4 P.I.D. Indicator	3-2
3.2.5 Controller Front Panel Buttons	3-2
3.2.6 Overheat Reset Switch	3-3
3.3 Rear Panel Connections	3-3
3.3.1 AC Power Input	3-3
3.3.2 Power Switch	3-3
3.4 Controller Parameters Settings	3-4
3.4.1 Changing Controller Parameter Settings	3-4
3.4.2 Changing The Temperature Setpoint	3-4
3.4.3 Changing The Display Units From °C to °F or (°F to °C)	3-4
3.5 Controller Parameter Factory Default Settings	3-5
3.6 Heat-up/Cool-Down Transition Times	3-5
3.7 Testing/Calibrating Temperature Probes	3-6
3.8 Cooling Down Procedure	3-6
Section 4 RS-232 Communication	4-1
4.1 Communication Port Location	4-1
4.2 Communication Cable Connections	4-1
4.3 CN9-SW Communication Software	4-1
4.4 Communication Settings and Programming	4-1
Section 5 Maintenance	5-1
5.1 Calibration	5-1
5.2 Cleaning	5-1
5.2.1 Main Body	5-1
5.2.2 Probe Well	5-1
5.2.3 Fan	5-1
5.3 Fuse Replacement	5-1
Section 6 Specifications	6-1
Section 7 Troubleshooting Guide	7-1
Section 8 Glossary of Terms Used in this Manual	8-1
The Omega Family of Dry Block Calibrators	8-2

Table of Figures

Figure	Description	Page
Figure	Description	Page
1.	IEC Symbols	1-2
2.	Maximum Setpoint Temperature Versus Ambient Temperature	2-2
3.	Front Panel	3-1
4.	Probe Well Styles	3-2
5.	Right Side Panel	3-3
6.	Rear Panel	3-3
7.	Controller Parameter Factory Default Settings	3-5
8.	Approximate Probe Well Heat-Up/Cool-Down Transition Times	3-5
9.	Calibrator Side View showing RS-232 Port	4-1
10.	Wiring Connections from Calibrator to PC	4-1

Section 1 - Introduction

Your CL1000 Series Mini hot point® has been designed for ease of use and reliability whenever you have the need to test or calibrate temperature probes. It is important that you read this manual completely and follow all safety precautions before operating this instrument.

1.1 Precautions

- Follow all safety precautions and operating instructions outlined in this manual.
- Never leave your calibrator unattended when in use.
- Keep out of reach of all children.
- Never touch the probe well or probes when hot without proper protection.
- Never place any objects other than temperature probes in the well.
- Do not operate in flammable or explosive environments.
- Never operate with a power cord other than the one provided with your unit.
- Turn unit off and disconnect main power cord before attempting any maintenance or fuse replacement.
- Never disconnect main power cord or main power source when unit is still hot.
- Do not connect and or operate this unit to a non-grounded, non-polarized outlet or power source.
- This unit is intended for indoor use only. Avoid exposure to moisture or high humidity.
- Never operate the unit outside.
- Do not return your unit to storage when **NOTE:** hot, allow unit to cool down to ambient temperature.

There are no user serviceable parts inside your unit. Attempting to repair or service your unit may void your warranty.

CAUTION:

This product is not designed for use in medical or nuclear applications.

WARNING:

1.2 Safety Warning

This calibrator can be set to very high temperatures. Exercise extreme caution when operating the unit. Keep hands and fingers away from the probe well area. Keep all flammable material such as paper, plastics and clothing away from the unit. The CL1000 is a Class II instrument. It is intended to be operated in laboratory environment only. Never remove power or store the unit while it is on or during "Cool Down."

1.3 IEC Symbols

this device as it contains important information relating to safety and EMC. Failure to follow all safety precautions may result in injury and or damage to your calibrator. Use of this device in a manner not specified by the manufacturer may impair protection provided within the unit.





IEC symbols	Description
	Caution, refer to accompanying documents
	Caution, hot surface
	Caution, risk of electric shock
	115 VAC @50/60Hz (Domestic Models) 230 VAC @50/60Hz (European Models)

Figure 1. IEC symbols

1.4 Statement on CE Marking

It is the policy of OMEGA to comply with all worldwide safety and EMI/EMC regulations that apply. OMEGA is constantly pursuing certification of its products to the European New Approach Directives. OMEGA will add the CE mark to every appropriate device upon verification of compliance.

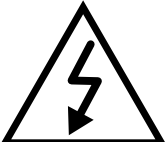
1.5 General Description

The CL1000 is a portable, rugged, benchtop, dry block calibration source with a built-in precision PID digital controller. The calibrator is used to test and calibrate temperature probes. The probe well can be set to any temperature between ambient +11 to 260°C (ambient +20 to 500°F)

1.6 Available Models

Model No.*	Well Style	HOLE SIZE										Qty.
		1/16"	1/8"	5/32"	3/16"	1/4"	1.5mm	2.0mm	3.0mm	4.5mm	6.0mm	
CL1000A	Standard	1	2	1	1	1						
CL1000B	Standard		2		1	2						
CL1000C	Standard	2	2		2							
CL1000D	Metric						1	1	1	1	1	

*Add suffix "-230 VAC" for 230 VAC models

Section 2 - Installation

2.1 Unpacking

Remove the packing list and verify that you have received all your equipment. If you have any questions about the shipment, please call our Customer Service Department at

1-800-622-2378 or 203-359-1660. We can also be reached on the Internet at www.omega.com
e-mail: cservice@omega.com

When you receive the shipment, inspect the container and equipment for any signs of damage. Note any evidence of rough handling in transit. Immediately report any damage to the shipping agent.

NOTE:

The carrier will not honor any damage claims unless all shipping material is saved for inspection. After examining and removing contents, save packing material and carton in the event reshipment is necessary.

The following items are supplied in the box:

- This Manual, # M-3529 (1 ea.)
- Power Cord (1 ea.)
- Calibration Certificate (2 data points)
- Soft Carrying Case (1 ea.)

2.2 Mounting

Mount the unit in an ambient environment between the specified 32 to 122°F (0 to 50°C) on a bench, table top or shelf in a horizontal position and operate at least ten inches from any air obstructions to the fan, front panel or rear panel. Do not block the bottom or top vented covers of the unit.

2.3 Environmental Operating Conditions

This unit is intended for indoor use only. Avoid exposure to moisture. The CL1000 is a Class II instrument. It is intended to be operated in laboratory environment only.

2.3.1 Ambient Temperature Effects

The probe well of the CL1000 can be controlled to any temperature within the specified temperature range of ambient +11 to 260°C (ambient +20 to 500°F) when being operated in ambient temperatures up to 24°C (75°F).

NOTE:

When operating the unit at higher ambient temperatures, do not exceed the "Maximum Allowable Probe Well Temperature" shown in Figure 2. Failure to adhere to these guidelines may cause a safety switch inside the unit to open the heater circuit. If this occurs refer to section 3.2.6.

Amb. Temp. °C (°F)	Max. Setpoint °C (°F)
24.0 (75)	260 (500)
24.4 (76)	252 (486)
25.6 (78)	244 (472)
26.7 (80)	237 (458)
27.8 (82)	229 (444)
28.9 (84)	221 (430)
30.0 (86)	213 (416)
31.1 (88)	205 (402)
32.2 (90)	198 (388)
33.3 (92)	190 (374)

Figure 2. Maximum Setpoint Temperature Versus Ambient Temperature

NOTE:

An increase in ambient temperature of 0.6°C (1°F) above 24°C (75°F) reduces the maximum allowable probe well temperature by 4°C (7°F).

2.3.2 Relative Humidity

Only operate your calibrator in a Relative Humidity environment of up to 80% RH (Non-Condensing).

2.4 Power Connection and Requirements

CAUTION:

Electrical connections and wiring should be performed only by suitably trained personnel.

Connect to a stable, earth grounded AC mains supply of the correct voltage for the model calibrator you have. Use the power cord provided.

Calibrator power requirements

- 3.15 amps @ 115 VAC (±10%) 50/60 Hz.
- 1.6 amps @ 230 VAC (±10%) 50/60 Hz.

WARNING:

High voltage is present at the power cord connection and inside the calibrator's enclosure when connected to the AC mains supply. Do not remove the top or bottom cover of the calibrator for any reason.

NOTE:

There are no user serviceable parts inside the calibrator. Attempting to service and/or repair your unit may void your warranty.

2.4.1 Standard (115 VAC~, 50/60 Hz Models)

The CL1000 comes with a standard North American 3-prong AC power cord. Do not use any other power cord other than the one provided. This cord provides the proper grounding and has been safety tested by the proper safety agencies.

2.4.2 International (230 VAC~, 50/60 Hz Models)

On "-230VAC" models an International style power cord with the proper color code and approvals is provided with stripped wire ends for connection to the proper connector used in your country or local area, this connector is not provided. Do not use any other power cord other than the one provided. This cord provides the proper grounding and has been safety tested by the proper safety agencies. Make sure when installing your connector to the wire ends that the ground connection has been

NOTE:

Fluctuations in the AC mains powering your calibrator can reduce the accuracy and/or stability of your calibrator. It is important that you connect your unit to a very stable power source of the proper voltage.

Notes:

Section 3 - Operation

3.1 Important Notes On Calibrator Operation

- The calibrator is a precision instrument. Although it has been designed for optimum durability and trouble-free operation, it must be handled with care.
- The probe well can be set to very high temperatures. Probes can be very hot when they are removed from the well. Take precautions to prevent personal injury to yourself, others and objects in the work area.
- Keep the calibrator connected to the main power source during cool-down period. If the power switch on the calibrator is turned to the “standby” position  when the probe well is still hot, a thermal sensor inside the calibrator will re-activate the cooling fan. The fan will then cycle on and off until the unit is at a safe temperature for power removal or storage.
- After inserting or removing probes into the probe well allow the calibrator time to stabilize before making your measurement. Adding or removing probes changes the total mass of the probe well, the controller will require time to adjust for this change and stabilize back to the temperature you have set.

3.2 Front and Side Panel Controls and Indicators

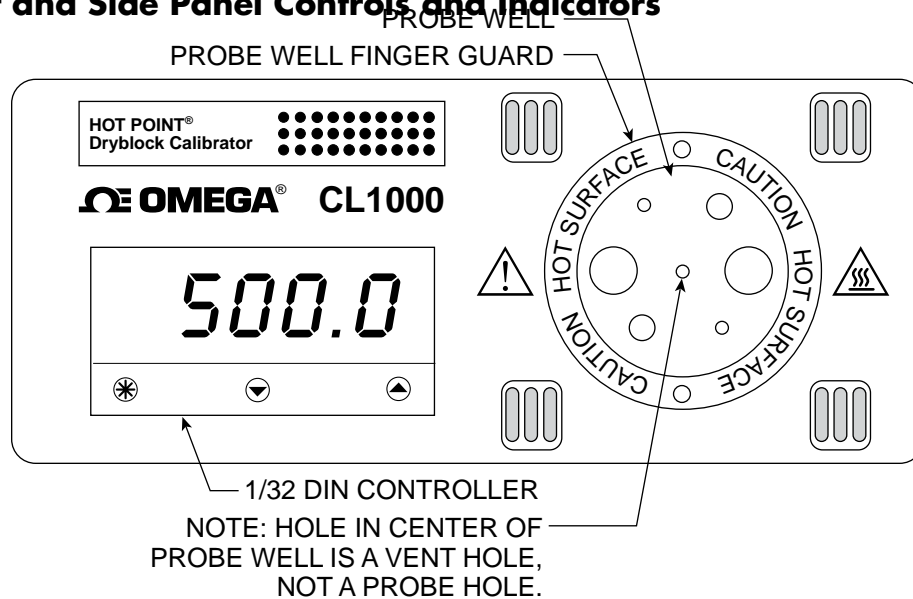

Figure 3. Front Panel

3.2.1 Process Temperature/Setpoint Temperature Display

In the default mode, the display will show the process temperature, i.e. the probe well temperature. When the modify key is held down, the setpoint temperature is displayed.

3.2.2 Probe Well

WARNING:

This calibrator can be set to very high temperatures. Exercise extreme caution when operating the unit. Keep hands and fingers away from the probe well area. Keep all flammable material such as paper, plastics and clothing away from the unit.

3.2.3 Available Probe Well Styles

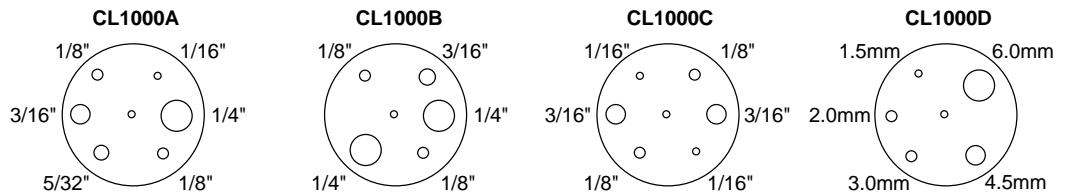

Figure 4. Probe Well Styles

3.2.4 P.I.D. Indicator

When this light is pulsating, the unit is heating up the target plate.

A NOTE:

P.I.D. Control:

Proportional, integral, derivative control (P.I.D.) is a temperature control algorithm used in high end temperature controllers. The controller causes the process to attain the desired temperature by turning the process on or off. The process may be a heater or refrigerator. As the process temperature approaches the setpoint temperature the hot or cold process will be pulsed to reduce the corrective measures and minimize overshooting. The controller provides a visual representation of the process status through LED indicators. An indicator may be lit continuously, blink or shut off entirely to indicate that the process is on, being pulsed, or off, respectively.

3.2.5 Controller Front Panel Buttons



Modify Key: Press/Hold to view and change setpoint.



Decrease Key: Press in conjunction with "Modify Key" in order to decrease setpoint.



Increase Key: Press in conjunction with "Modify Key" in order to increase setpoint.

3.2.6 Overheat Reset Switch

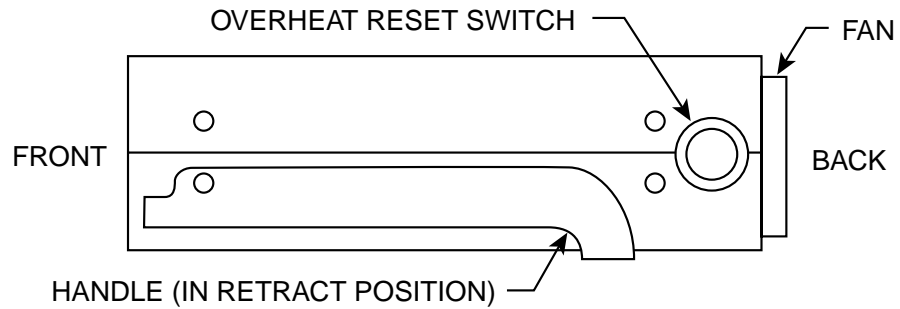

Figure 5. Right Side Panel

If the unit is operated at high temperatures in elevated ambient temperatures, an overheat condition may occur. In an overheat situation a mechanical reset switch on the right side panel will pop and open the heater circuit (see figure 5). The controller will still have power. While the controller will be demanding heat from the heater, the process temperature will fall continuously until it equalizes with room temperature. If an overheat condition occurs, let the unit cool off for one hour (leave unit on), then press the reset button, firmly. If this does not correct the problem, contact the factory.

3.3 Rear Panel Controls and Connections

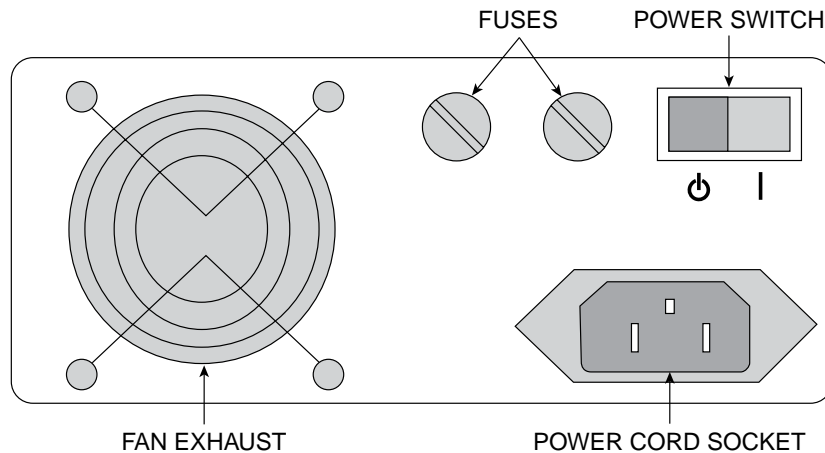

Figure 6. Rear Panel

3.3.1 AC Power Input

The customer connects the power cord to the AC Power Input on the rear panel.

3.3.2 Power Switch

The power switch has two positions, "ON" and "STANDBY."

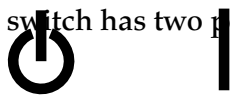

STANDBY ON

In the "ON" position, the entire unit is powered up.

In the STANDBY mode, the unit is powered down except for the fan. If the unit has been operated at high temperature and is then put into standby mode, the fan will continue to run until the probe well has cooled down to room temperature.

3.4 Controller Parameter Settings

3.4.1 Changing Controller Parameter Settings

The parameters in your calibrator have been set and fine-tuned to provide the best performance possible from your unit. The unit will operate at its optimum performance when left with the factory parameter settings. The only parameter that the operator should change is the temperature setpoint or displayed engineering units (°F or °C). **Changing any other parameter settings will decrease the accuracy and stability of your calibrator.**

3.4.2 Changing The Temperature Setpoint

The CL1000 incorporates a PID digital setpoint controller. In the default mode the digital display indicates the probe well temperature known as (PV) Process Variable. Holding down the modify button causes the display to show the programmed setpoint known as (SV) Setpoint Variable. Making changes to the setpoint or units of measurement settings are made by pressing the (Modify) button in conjunction with the ▲ (Up arrow) button or ▼ (Down arrow) button. Holding the (Modify) button and (Up arrow)/ (Down arrow) button for an extended period will cause the setpoint temperature to advance more rapidly to a desired value. The minimum and maximum setpoints are locked out at 0 and 260°C (32 and 500°F), respectively.

WARNING:

Do not re-program the controller's parameter settings or change wiring inside your unit to override the maximum setpoint value of 260 °C (500 °F). You may permanently damage your calibrator and cause possible personal injury and/or create a fire hazard.

3.4.3 Changing The Display Units From °C to °F or (°F to °C)

Press and hold the ▲ (Up arrow) and ▼ (Down arrow) buttons on the controller at the same time for 3-4 seconds, then release. The display will be flashing between "tune - off". Press the ▼ (Down arrow) button one time. The display will be flashing between "LEVEL-1". While holding the (Modify) key down press the ▲ (Up arrow) button one time. The display will be flashing between "LEVEL-2". Now that you are on menu level 2 release the button. Press the ▲ (Up arrow) button eleven times. The display will now be flashing between "unit - °F" or "unit-°C". To change the current units setting press and hold the (Modify) button, then press the ▲ (Up arrow) or ▼ (Down arrow) button one time to change between units. To save your change and return to the run mode press and hold the ▲ (Up arrow) and ▼ (Down arrow) buttons at the same time for 3-4 seconds, then release.

3.5 Controller Parameter Factory Default Settings

LEVEL 1		LEVEL 2		LEVEL 3	
TUNE	OFF	SP1.P	0	SP1.d	SSd1
BAND	A 53	hAnd	OFF	SP2.d	SSd2
int.t	A 3.3	PL.1	100	burn	Up.SC
der.t	A 11	PL.2	100	rEU.d	lr.2d
DaC	A 4.0	sp2.A	nonE	rEU.L	ln.2n
CyC.t	9.7	sp2.b	nonE	Span	13
OFSt	0	di Sp	0.1	Zero	-0.5
SP.Lk	OFF	hi.SC	500.0	ChEK	oFF
SP.rr	0	lo.SC	32.0	rEAd	VAr
SPrn	OFF	inPt	rtd	tECh	Ct A
SoAK	--	unit	F	UEr	392
SEt.2	0.0			rSEt	nonE
bnd.2	N/A				
CyC.2	N/A				

Figure 7. Factory Default Settings

3.6 Heat-Up/Cool-Down Transition Times

This chart illustrates the approximate time required to make a transition from one temperature to another in minutes. Once reaching the desired temperature, the probe well must be allowed to soak at the new temperature for a period of time to reach full stabilization.*

TO FROM		Temperature C (F)				
		38 (100)	93 (200)	149 (300)	204 (400)	260 (500)
Temperature C (F)	38 (100)		12	13	14	15
	93 (200)	50		13	14	15
	149 (300)	60	25		12	13
	204 (400)	65	30	15		12
	260 (500)	70	35	25	15	

Time (Minutes)

Figure 8. Approximate Probe Well Heat-Up/Cool-Down Transition Times

* First determine the current plate temperatures and go to the corresponding row. Now decide the new target plate temperature and go to the appropriate column. Note that there are X's along the diagonal to ensure the original and target temperatures are the same.

3.7 Testing/Calibrating Temperature Probes



CAUTION:

Handle hot probes carefully. Use protection for your hands and the surface you will be placing the hot probes on after removing them from the well.

When calibrating probes at different temperature points, start at the lowest temperature and work up to the highest temperature. Do not jump up and down from a very hot temperature to a relatively cooler temperature. This will reduce the time it takes for the probe well to re-stabilize after you change the setpoint. When placing probes into the well, make sure the probe tip goes all the way down to the bottom of the probe well, the full 4.5". This will insure the degree of highest accuracy possible when taking your reading.

After calibrating each probe, remove it from the well and place it on a protected surface to cool. If you have another probe to calibrate, place it into the probe well and allow the calibrator a few minutes to re-stabilize.

3.8 Cooling Down Your Calibrator After Use



CAUTION:

Do not remove the power cord, main line power or turn the calibrator off until completing the cool-down procedure.

When you have completed working with the calibrator you must cool the unit down to ambient temperature if you intend to move your unit.

Cool-Down Procedure:

1. Turn the calibrator to the "standby" mode (See section 3.3)
2. The cooling fan may continue to run or turn on after a several minutes if the heater assembly inside the unit has not yet fully cooled down to ambient temperature. Do not remove the power cord or the main line power until the fan stops running permanently.
3. It is now safe to remove your unit from the power source and/or return to storage.

Section 4 - RS-232 Communication

NOTE:

This section only applies to CL1000 Series Calibrators purchased with optional RS-232 Communications (-C2) Option.

4.1 Communication Port Location

The RS-232 communication port is located on the left side of the CL1000 Series calibrators as shown in Figure 9.

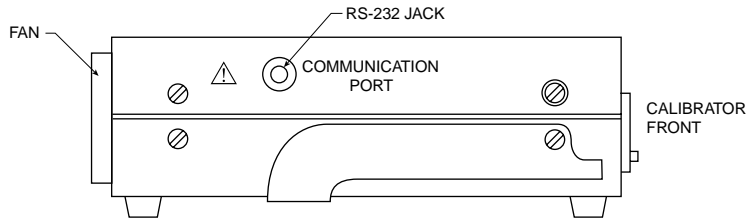

Figure 9. Calibrator Side View showing RS-232 Port

4.2 Communication Cable Connections

Your calibrator unit has been factory pre-wired and configured for ease of use with a stereo jack connection on the side panel that will require no additional wiring. An interface cable, Part No. OM-NOMAD-CP9 is included with your unit for easy connection between your benchtop calibrator and PC.

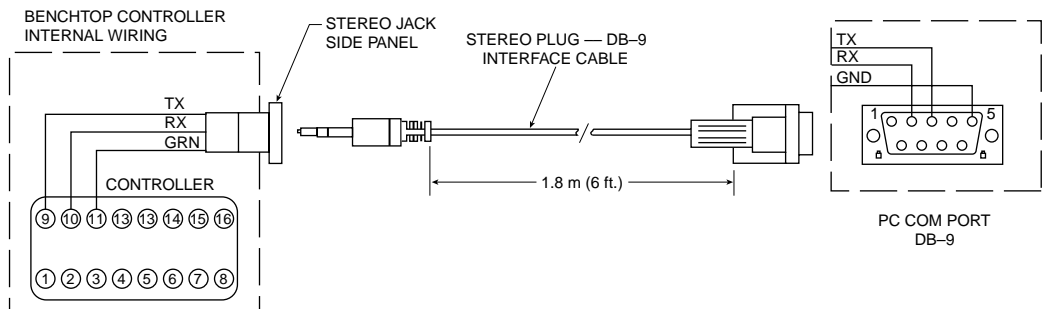

Figure 10. Wiring Connections from Calibrator to PC

4.3 CN9-SW Communication Software

Calibrators with the -C2 option come complete with communication software, OMEGA part number CN9-SW. The software is designed to interface with your calibrator when the optional communication hardware has been factory installed in your unit.

NOTE:

The CN9-SW software is Windows 95/98/NT/2K/XP compatible.

4.4 Communication Settings and Programming

Refer to the Software Communication Manual (M2896) for factory default settings and for making changes to the communications settings and programming.

Section 5 - Maintenance

5.1 Calibration

This unit has been fine tuned at the factory and calibrated to give optimum performance of its full temperature range. It is recommended that the unit be returned annually for re-calibration.

5.2 Cleaning



Remove all electrical connections and power before attempting any maintenance or cleaning.

5.2.1 Main Body

Use only a slightly damp, soft, clean cloth with a mild cleaning solution.

5.2.2 Probe Well

Do not attempt to clean the probe well. Cleaning is not required.

5.2.3 Fan

The fan guard should be cleaned as a minimum annually by using a compressed air source.

5.3 Fuse Replacement



Disconnect all power from source before attempting fuse replacement.



For continued protection against the risk of fire, replace with only the same size, type and rating fuse indicated here and on the rear panel of your unit.

For model: 120 VAC Models 1 ea. F3.15A, 250 VAC ~ (Fast-Acting, 3.15 Amp)
VDE APPROVED (5 mm dia. x 20 mm long).

For model: 230 VAC Models 2 ea. F1.6A, 250 VAC ~ (Fast-Acting, 1.6 Amp)
VDE APPROVED (5 mm dia. x 20 mm long).



For the -230VAC models, both fuses must be checked if the unit does not operate. One or both fuses may have been damaged.

Section 6 - Specifications

Target Plate Temperature Range:	Ambient + 11°C to 260°C* (Ambient + 20°F to 500°F)*
Accuracy:	±1.5°C (±2.75°F)
Display Resolution:	0.1°
Stability:	±0.15°C (±0.3°F)**
Probe Well Uniformity:	±0.15°C (±0.3°F)
Heat-Up Time:	from 38 to 260°C (100 to 500°F) (15 Minutes)
Cool-Down Time:	from 260° to 38°C (500 to 100°F) (70 Minutes)
Ambient Environmental Conditions	
Temperature:	0 to 50°C (32 to 122°F)*
Humidity:	0 to 80% RH, non-condensing
Internal Control Sensor:	Platinum RTD, 100 Ω, .00385, Class A
Power Requirements	
Model CL1000A, B, C, D:	3.15 Amps @ 115 VAC~ (±10%) 50/60 Hz, 275W
Model CL1000A, B, C, D-230 VAC:	1.6 Amps @ 230 VAC~ (±10%) 50/60 Hz, 275W
Dimensions:	(127 x 56 x 155 mm) 5"w x 2.2"h x 6.1"d
Weight:	3.8 lbs. (1.7 Kg.)
Approvals:	CE (-230 VAC models only)
Installation Category II	

* Maximum setpoint must be reduced when operating at ambient temperatures in excess of 24°C (75°F) See Section 2.3

** With stable, correct nominal line voltage. (See Section 2.4)

Section 7 - Troubleshooting Guide

Problem	Solution
1. Unit will not turn on.	<ol style="list-style-type: none">Check all electrical connections.Check rear panel fuse(s).Unit requires service, contact our customer service department.
2. Unit turns on but the probe setpoint will not heat-up.	<ol style="list-style-type: none">Confirm that you have entered a value above the ambient temperature.Verify that the controller is set to its factory default settings.An overheat condition may have occurred. Refer to section 3.3.Unit requires service, contact our customer service department.
3. Display flashing "inPt".	<ol style="list-style-type: none">Unit requires service, contact our customer service department.
4. Probe well temperature will not stabilize within Specifications.	<ol style="list-style-type: none">Verify that the controller is set to its factory default settings.Verify line voltage is correct level and stable.Unit requires service, contact our customer service department.

Section 8 - Glossary of Terms Used in this Manual

Calibration

The process of adjusting an instrument or compiling a deviation chart so that its reading can be correlated to the actual value being measured.

IEC

International Electrotechnical Commission

NIST

National Institute of Standards and Technology

PID

Proportional, Integral, Derivative. A three mode control action where the controller has time proportioning, integral (auto reset) and derivative rate action.

RTD

Resistance temperature detector

The OMEGA® Family of Dry Block Probe Calibrators

Listed below is a selection guide of OMEGA's current line of dry block probe calibrators that are in addition to the one you have selected. This family of rugged, portable and highly accurate calibrators covers a wide range of temperatures, well sizes and features making them perfect for temperature probe testing and calibration.

Model: CL900 "hot point®" Dry Block Probe Calibrator
Temperature Range: ambient +22 to 482°C (ambient +40 to 900°F)
Accuracy: +/- 1.5°F
Control Stability: +/- 0.3°F **Power:** 115 or 230 VAC(±10%) 50/60 Hz
Features: Removable inserts, Rugged benchtop design, Low cost

Model: CL950 "hot point®" Dry Block Probe Calibrator
Temperature Range: ambient +22 to 482°C (ambient +40 to 900°F)
Accuracy: +/- 1.5°F
Control Stability: +/- 0.3°F **Power:** 115 or 230 VAC(±10%) 50/60 Hz
Features: 5 port well design standard, Rugged benchtop design, Low cost

Model: CL900A "hot point®" Dry Block Probe Calibrator
Temperature Range: ambient +22 to 482°C (ambient +40 to 900°F)
Accuracy: +/- 1.5°F
Control Stability: +/- 0.3°F **Power:** 115 or 230 VAC(±10%) 50/60 Hz
Features: Removable inserts, Rugged portable/benchtop design, RS-232 Communication Standard, CE marked models

Model: CL950A "hot point®" Dry Block Probe Calibrator
Temperature Range: ambient +22 to 482°C (ambient +40 to 900°F)
Accuracy: +/- 1.5°F
Control Stability: +/- 0.3°F **Power:** 115 or 230 VAC(±10%) 50/60 Hz
Features: 5 port well design standard, Rugged portable/benchtop design, RS-232 Communication Standard, CE marked models.

Model: TRCIII A "ice point™" Calibration Reference Chamber
Temperature Range: Fixed @ 0°C (32 °F)
Accuracy: +/- 0.1°C
Control Stability: +/- 0.04°C **Power:** 115 or 230 VAC(±10%) 50/60 Hz
Features: Digital display, Rugged portable/benchtop design, CE marked models

Complete product specifications and features for these and additional calibrators can be found and downloaded from our web site. Visit us at omega.com

WARRANTY/DISCLAIMER

OMEGA ENGINEERING, INC. warrants this unit to be free of defects in materials and workmanship for a period of **37 months** from date of purchase. OMEGA's WARRANTY adds an additional one (1) month grace period to the normal **three (3) year product warranty** to cover handling and shipping time. This ensures that OMEGA's customers receive maximum coverage on each product.

If the unit malfunctions, it must be returned to the factory for evaluation. OMEGA's Customer Service Department will issue an Authorized Return (AR) number immediately upon phone or written request. Upon examination by OMEGA, if the unit is found to be defective, it will be repaired or replaced at no charge. OMEGA's WARRANTY does not apply to defects resulting from any action of the purchaser, including but not limited to mishandling, improper interfacing, operation outside of design limits, improper repair, or unauthorized modification. This WARRANTY is VOID if the unit shows evidence of having been tampered with or shows evidence of having been damaged as a result of excessive corrosion; or current, heat, moisture or vibration; improper specification; misapplication; misuse or other operating conditions outside of OMEGA's control. Components in which wear is not warranted, include but are not limited to contact points, fuses, and triacs.

OMEGA is pleased to offer suggestions on the use of its various products. However, OMEGA neither assumes responsibility for any omissions or errors nor assumes liability for any damages that result from the use of its products in accordance with information provided by OMEGA, either verbal or written. OMEGA warrants only that the parts manufactured by the company will be as specified and free of defects. OMEGA MAKES NO OTHER WARRANTIES OR REPRESENTATIONS OF ANY KIND WHATSOEVER, EXPRESSED OR IMPLIED, EXCEPT THAT OF TITLE, AND ALL IMPLIED WARRANTIES INCLUDING ANY WARRANTY OF MERCHANTABILITY AND FITNESS FOR A PARTICULAR PURPOSE ARE HEREBY DISCLAIMED. LIMITATION OF LIABILITY: The remedies of purchaser set forth herein are exclusive, and the total liability of OMEGA with respect to this order, whether based on contract, warranty, negligence, indemnification, strict liability or otherwise, shall not exceed the purchase price of the component upon which liability is based. In no event shall OMEGA be liable for consequential, incidental or special damages.

CONDITIONS: Equipment sold by OMEGA is not intended to be used, nor shall it be used: (1) as a "Basic Component" under 10 CFR 21 (NRC), used in or with any nuclear installation or activity; or (2) in medical applications or used on humans. Should any Product(s) be used in or with any nuclear installation or activity, medical application, used on humans, or misused in any way, OMEGA assumes no responsibility as set forth in our basic WARRANTY/DISCLAIMER language, and, additionally, purchaser will indemnify OMEGA and hold OMEGA harmless from any liability or damage whatsoever arising out of the use of the Product(s) in such a manner.

RETURN REQUESTS/INQUIRIES

Direct all warranty and repair requests/inquiries to the OMEGA Customer Service Department. BEFORE RETURNING ANY PRODUCT(S) TO OMEGA, PURCHASER MUST OBTAIN AN AUTHORIZED RETURN (AR) NUMBER FROM OMEGA'S CUSTOMER SERVICE DEPARTMENT (IN ORDER TO AVOID PROCESSING DELAYS). The assigned AR number should then be marked on the outside of the return package and on any correspondence.

The purchaser is responsible for shipping charges, freight, insurance and proper packaging to prevent breakage in transit.

FOR **WARRANTY** RETURNS, please have the following information available BEFORE contacting OMEGA:

1. Purchase Order number under which the product was PURCHASED,
2. Model and serial number of the product under warranty, and
3. Repair instructions and/or specific problems relative to the product.

FOR **NON-WARRANTY** REPAIRS, consult OMEGA for current repair charges. Have the following information available BEFORE contacting OMEGA:

1. Purchase Order number to cover the COST of the repair,
2. Model and serial number of the product, and
3. Repair instructions and/or specific problems relative to the product.

OMEGA's policy is to make running changes, not model changes, whenever an improvement is possible. This affords our customers the latest in technology and engineering.

OMEGA is a registered trademark of OMEGA ENGINEERING, INC.

© Copyright 2017 OMEGA ENGINEERING, INC. All rights reserved. This document may not be copied, photocopied, reproduced, translated, or reduced to any electronic medium or machine-readable form, in whole or in part, without the prior written consent of OMEGA ENGINEERING, INC.

Where Do I Find Everything I Need for Process Measurement and Control?

OMEGA...Of Course!

Shop online at omega.comSM

TEMPERATURE

- Thermocouple, RTD & Thermistor Probes, Connectors, Panels & Assemblies
- Wire: Thermocouple, RTD & Thermistor
- Calibrators & Ice Point References
- Recorders, Controllers & Process Monitors
- Infrared Pyrometers

PRESSURE, STRAIN AND FORCE

- Transducers & Strain Gages
- Load Cells & Pressure Gages
- Displacement Transducers
- Instrumentation & Accessories

FLOW/LEVEL

- Rotameters, Gas Mass Flowmeters & Flow Computers
- Air Velocity Indicators
- Turbine/Paddlewheel Systems
- Totalizers & Batch Controllers

pH/CONDUCTIVITY

- pH Electrodes, Testers & Accessories
- Benchtop/Laboratory Meters
- Controllers, Calibrators, Simulators & Pumps
- Industrial pH & Conductivity Equipment

DATA ACQUISITION

- Data Acquisition & Engineering Software
- Communications-Based Acquisition Systems
- Plug-in Cards for Apple, IBM & Compatibles
- Data Logging Systems
- Recorders, Printers & Plotters

HEATERS

- Heating Cable
- Cartridge & Strip Heaters
- Immersion & Band Heaters
- Flexible Heaters
- Laboratory Heaters

ENVIRONMENTAL MONITORING AND CONTROL

- Metering & Control Instrumentation
- Refractometers
- Pumps & Tubing
- Air, Soil & Water Monitors
- Industrial Water & Wastewater Treatment
- pH, Conductivity & Dissolved Oxygen Instruments