

YEAR
2000
COMPLIANT

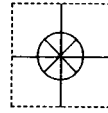

MADE IN
USA



User's Guide

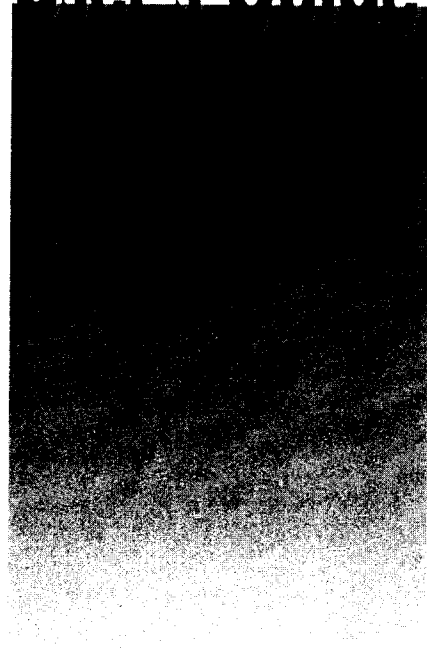

omega.com™
Ω OMEGA®

www.omega.com

[e-mail: info@omega.com](mailto:info@omega.com)

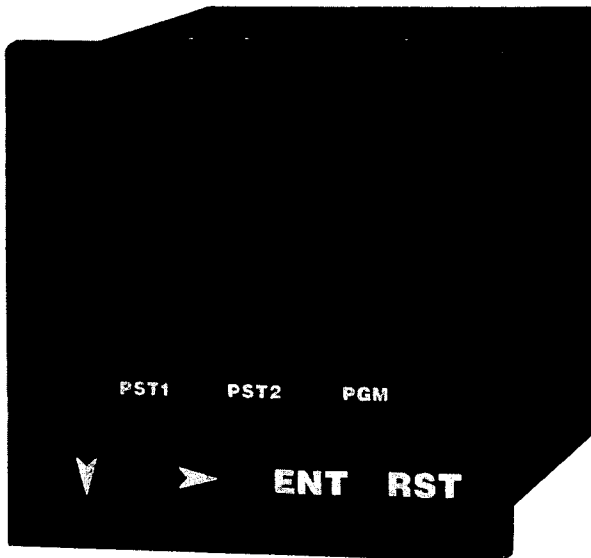

DPC-22 SERIES 1/16 DIN Preset Counters



OMEGAnet® On-Line Service
www.omega.com

Internet e-mail
info@omega.com

Servicing North America:

USA:
ISO 9001 Certified

One Omega Drive, Box 4047
Stamford CT 06907-0047
Tel: (203) 359-1660 FAX: (203) 359-7700
e-mail: info@omega.com

Canada:

976 Bergar
Laval (Quebec) H7L 5A1
Tel: (514) 856-6928 FAX: (514) 856-6886
e-mail: info@omega.ca

For immediate technical or application assistance:

USA and Canada: Sales Service: 1-800-826-6342 / 1-800-TC-OMEGA®
Customer Service: 1-800-622-2378 / 1-800-622-BEST®
Engineering Service: 1-800-872-9436 / 1-800-USA-WHEN®
TELEX: 996404 EASYLINK: 62968934 CABLE: OMEGA

Mexico:

Tel: (001) 800-826-6342 FAX: (001) 203-359-7807
En Español: (001) 203-359-7803 e-mail: espanol@omega.com
info@omega.com.mx

Servicing Europe:

Benelux:

Postbus 8034, 1180 LA Amstelveen, The Netherlands
Tel: +31 20 6418405 FAX: +31 20 6434643
Toll Free in Benelux: 0800 0993344
e-mail: nl@omega.com

Czech Republic:

Rudé armády 1868, 733 01 Karviná 8
Tel: +420 (69) 6311899 FAX: +420 (69) 6311114
Toll Free: 0800-1-66342 e-mail: czech@omega.com

France:

9, rue Denis Papin, 78190 Trappes
Tel: +33 130-621-400 FAX: +33 130-699-120
Toll Free in France: 0800-4-06342
e-mail: france@omega.com

Germany/Austria:

Daimlerstrasse 26, D-75392 Deckenpfronn, Germany
Tel: +49 (07056) 3017 FAX: +49 (07056) 8540
Toll Free in Germany: 0800 TC-OMEGASM
e-mail: germany@omega.com

United Kingdom:

ISO 9002 Certified

One Omega Drive, River Bend Technology Centre
Northbank, Irlam, Manchester
M44 5EX United Kingdom
Tel: +44 (0)161 777 6611 FAX: +44 (0)161 777 6622
Toll Free in United Kingdom: 0800-488-488
e-mail: sales@omega.co.uk

It is the policy of OMEGA to comply with all worldwide safety and EMC/EMI regulations that apply. OMEGA is constantly pursuing certification of its products to the European New Approach Directives. OMEGA will add the CE mark to every appropriate device upon certification.

The information contained in this document is believed to be correct, but OMEGA Engineering, Inc. accepts no liability for any errors it contains, and reserves the right to alter specifications without notice.

WARNING: These products are not designed for use in, and should not be used for, patient-connected applications.

OVERVIEW

CONSTRUCTION

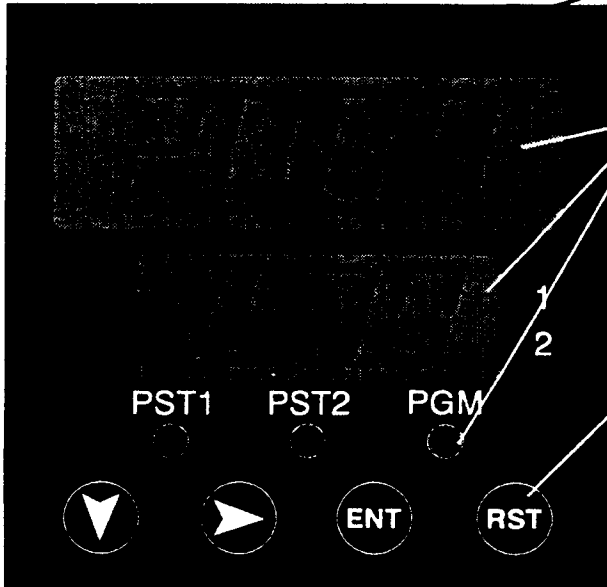

Compact Design

Uses only 48mm of panel space. 110mm behind-panel depth.

Dual Four-character Display

Simultaneous display of Count and Preset data. Red LED display. Annunciators show input, display and output status.

Ergonomic Keypad

Simple key sequences to view and edit Presets. Front Panel Reset key can be disabled.

Front Panel Seal

NEMA 4/IP65-rated when installed with panel mount gasket supplied.

Rear Terminal Connections

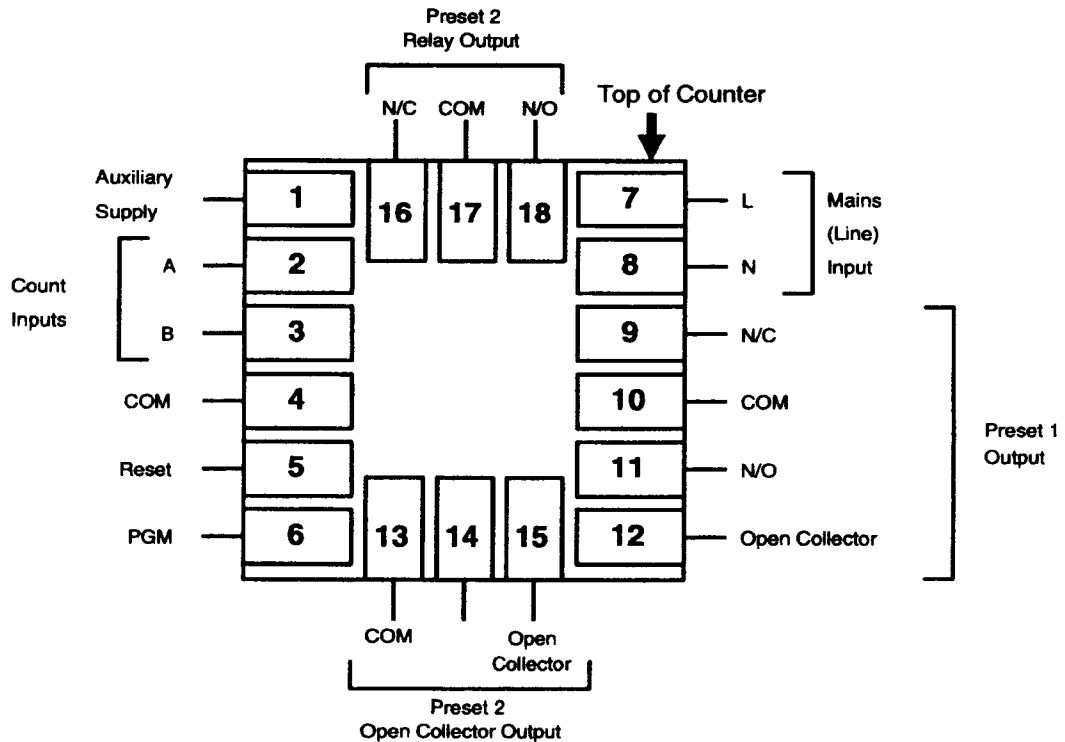

INSTALLATION

WIRING

IMPORTANT: In severe electrical noise environments, shielded cable is recommended for inputs and outputs. Connect the shield only to the building earth (ground).

AC Power Input

Connect AC power to Terminal 7 (Line) via a 1A slow-blow fuse and to Terminal 8 (Neutral) - see below. AC power should be from a separate branch circuit which is noise-free and does not feed heavy loads.



DC/Low Voltage AC Power Input

Connect DC/low voltage AC power to Terminal 7 (+) via a 0.5A slow-blow fuse and to Terminal 8 (-) - see below. DC power should have low ripple and be noise-free.

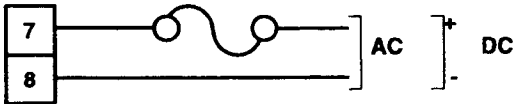

Reset and Program Inputs

Connect Reset pushbutton or current sink device to Reset (Terminal 5) and COM (Terminal 4). Connect Program switch or jumper to PGM (Terminal 6) and COM (Terminal 4).

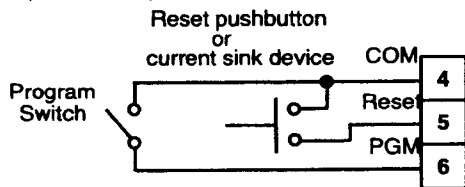

Bi-directional Quadrature Inputs

Connect Quadrature Encoder to V+ (Terminal 1), A input (Terminal 2), B input (Terminal 3) and COM (Terminal 4) as shown below. In Configuration Mode, set **InPu** parameter to **QuAd**. For NPN open collector devices with no pullup resistors, set **PuLL** parameter to **YES**.

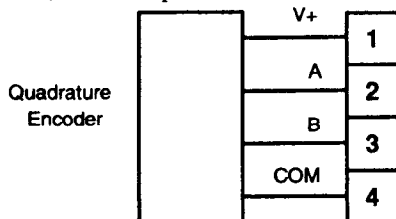

Current Sourcing (PNP) Count Inputs

Connect Add count input to Terminal 2 (A) and/or Subtract count input to Terminal 3 (B) - see below. In Configuration Mode, set **PuLL** parameter to **no** and, for Add/Subtract operation, set **InPu** parameter to **A-B**.

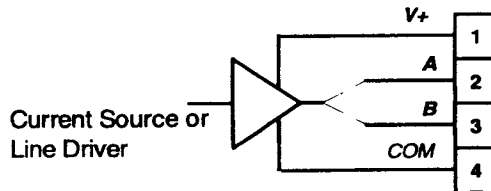
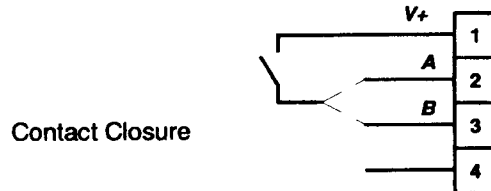
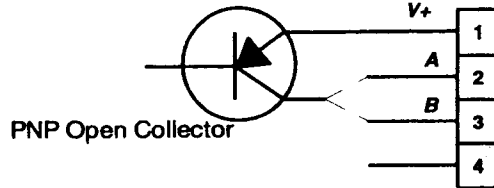

Current Sinking (NPN) Count Inputs

Connect Add count input to Terminal 2 (A) and/or Subtract count input to Terminal 3 (B) - see below. In Configuration Mode, set **PuLL** parameter to **YES** and, for Add/Subtract operation, set **InPu** parameter to **A-B**.

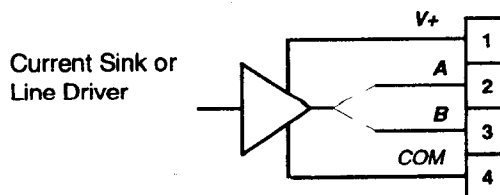
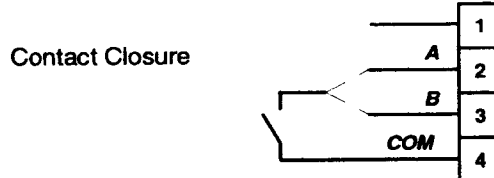
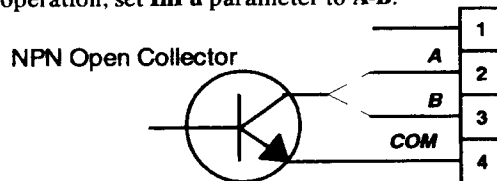

INSTALLATION

Relay Output

Connect AC or DC load circuits to Terminals 9, 10 & 11 (Preset 1) or 16,17 & 18 (Preset 2) as required. Do not route load wiring near count input or transistor output signals.

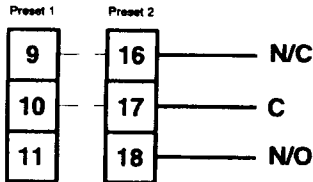

Open Collector Output

Connect Terminals 12 (Preset 1 open collector) and 4 (COM) or 15 (Preset 2 Open Collector) and 13 (COM) to solid state devices as below (upper circuit). To drive DC relay coils, connect Terminal 12 or 15 and V+ (Terminal 1) as below (lower circuit). Suppress switching transients with a suppression diode, connected as shown.

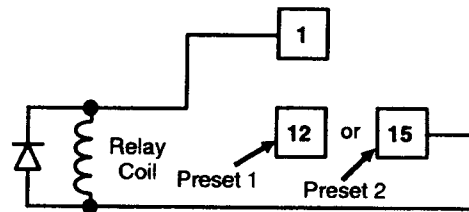
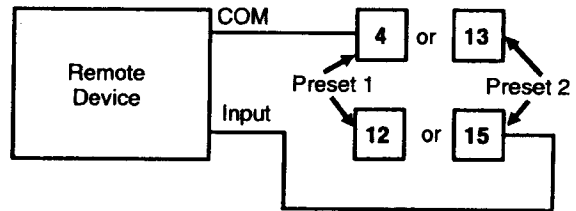

PANEL MOUNTING

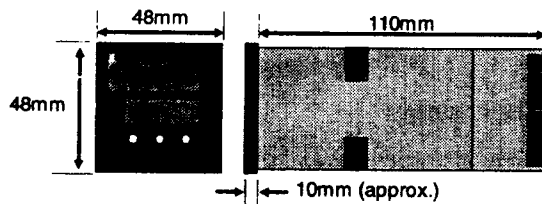

Panel Mounting

Make cut-out(s) according to the details in the diagram on the right. The maximum panel thickness is 6 mm.

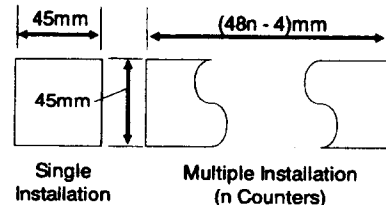

CAUTION

Do not remove the panel gasket from the Counter as this may result in inadequate clamping of the Counter in the mounting panel.

Insert the rear of the Counter housing through the cut-out (from the front of the mounting panel) and hold the Counter lightly in position against the panel. Ensure that the panel gasket is not distorted and that the Controller is positioned squarely against the mounting panel. *Apply pressure to the front panel bezel only.* Slide the mounting bracket in place (see right) and push it forward until it is firmly in contact with the rear face of the mounting panel (tongues on the bracket should engage in matching ratchet positions on the Counter housing and the mounting bracket springs should push firmly against the mounting panel rear face).

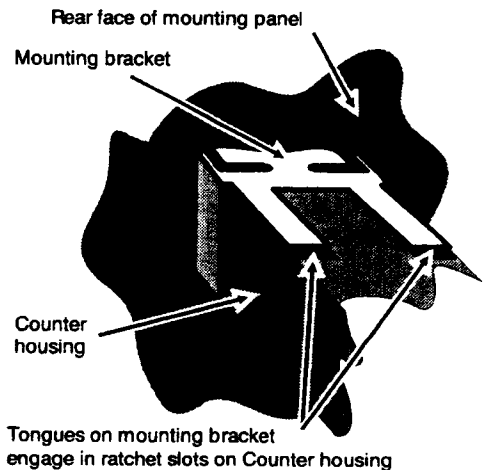

OPERATION

FRONT PANEL

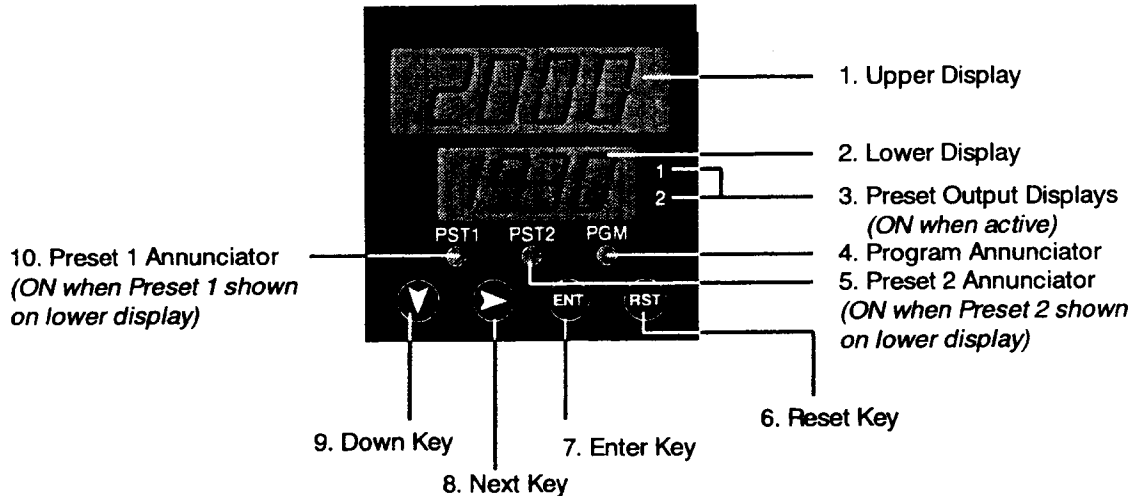

Down key

Operator Mode: Used to change the currently-selected (flashing) digit. Depressing this key will decrement the value (wrap-around from 0 to 9). If the key is held continuously, the value will decrement at the rate of 2/sec.

Program Mode: Used to advance from one parameter to the next. Once a parameter value has been selected for editing (through use of the Next key), depressing this key will decrement the value (wrap-around from 0 to 9). If the key is held continuously, the value will decrement at the rate of 2/sec.

Configuration Mode: Used to advance from one parameter to the next.



Next key

Operator Mode: Used to select a parameter for editing (left-most digit will start to flash) and to move between the digits. Once the proper digit is selected (flashing) with the Next key, its value can be altered through use of the Down key.

Program Mode: Used to select a parameter for editing (left-most digit will start to flash) and to move between the digits. Once the proper digit is selected (flashing) with the Next key, its value can be altered through use of the Down key. For Decimal Point Position, this key scrolls through the available choices.

Configuration Mode: Used to select a parameter for editing and to scroll through available choices.



RST key

Operator Mode/Program Mode: Resets count value to either zero or Preset value (based on the setting of the Count Direction parameter in Configuration Mode). Also releases latched outputs.

Configuration Mode: Exits Configuration Mode when held down for 2 seconds.

NOTE: The **RST** key will not be active unless enabled in Configuration Mode.



ENT key

Operator Mode/Program Mode: Confirms an edited value (display will cease flashing after the **ENT** key is depressed).

Configuration Mode: Confirms setting/value selection (display will cease flashing after the **ENT** key is depressed).

For information on Operator Mode, see Page 6.

For information on Program Mode, see Page 7.

For information on Configuration Mode, see Page 8.

NOTE

To abort changes to a parameter value, press Down and Next together instead of **ENT**.

IMPORTANT

In Edit Mode, you must press the **ENT** key within 15 seconds of the last keypress, otherwise the new data will be lost and the old data will be restored.

PROGRAMMING

OPERATOR MODE

NOTE

Use Down key to select Count/Preset 1 display or Count/Preset 2 display (Count/Preset 1 display will be shown on power-up).

The Operator Mode is used for viewing the Count value and viewing/changing the Preset 1/Preset 2 value.

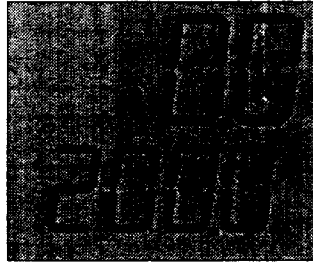

NOTE

To abort an edit operation (before the new value is confirmed), press the Down and Next keys together.

Counter value

Preset 1 or Preset 2 value

WARNING!

Caution should be observed if it is necessary to change the preset value while the process is operating. Do not set values which are already exceeded by the count value without resetting the counter.

Press the Next key to enter Edit Mode. The most significant digit of the Preset Data display will then flash. Press the Next key repeatedly as required to select the desired digit.

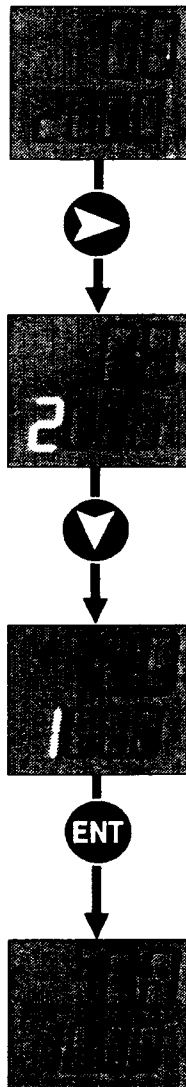

Press the Down key to change the value of the selected digit (there is wrap-round from 0 to 9).

When all digits are as required, press the ENT key to confirm the changes; the display will stop flashing.

IMPORTANT

You must press the ENT key within 15 seconds of the last keypress when entering a new value, otherwise the new value will be discarded and the old value will be retained.

PROGRAM MODE

WARNING!

Changing Program Mode parameter values while the process is operating may be hazardous to the operator and/or the controlled equipment. Use extreme caution and stop the process before attempting to change Program Mode parameter values.

IMPORTANT

You must press the **ENT** key to implement new parameter values.

NOTE

Possible Decimal Point Position settings are:

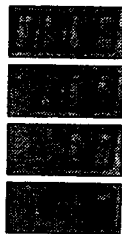

To enter Program Mode, set the PGM input active (low) e.g. by tying it to COM. Whilst in Program Mode, the **PGM indicator will be ON**.

Function	Parameter Description (Upper Display)	Meaning
Pre-scaler <i>INPUT COUNTER MULTIPLIER/DIVIDER</i>		Pre-scales counter operation. Value = $\frac{\text{Count units displayed}}{\text{Count pulses input}}$
Output 1 Time		Sets momentary ON time for PRESET 1 output (0.01 - 99.99s; 0.00 for latched operation)
Output 2 Time		Sets momentary ON time for PRESET 2 output (0.01 - 99.99s; 0.00 for latched operation)
Decimal Point		Defines decimal point position
Operator Mode: Preset 1	None	Shows Preset 1 value
Preset 2	None	Shows Preset 2 value

NOTES

1. To adjust Pre-scaler, Out Time or either Preset value (as selected), press Next key to enter Edit Mode (digits will flash), use Next key to select each digit to be adjusted, and adjust digit value using Down key. When adjustment is complete, press **ENT** key to exit Edit Mode (digits will become static).

2. To adjust decimal point position, select that parameter, press Next key to enter Edit Mode, then use Next key to position decimal point. Press **ENT** key when finished.

To exit Program Mode, set the PGM input inactive (High).

SET UP

CONFIGURATION MODE

To enter Configuration Mode, power-down the Counter and remove it from its housing. Change the setting of the plunger switch on the CPU PCB (the actual setting is irrelevant, as long as the setting is changed to the opposite state). Replace the Counter in its housing and power-up. The PGM indicator will flash whilst the Counter is in Configuration Mode.

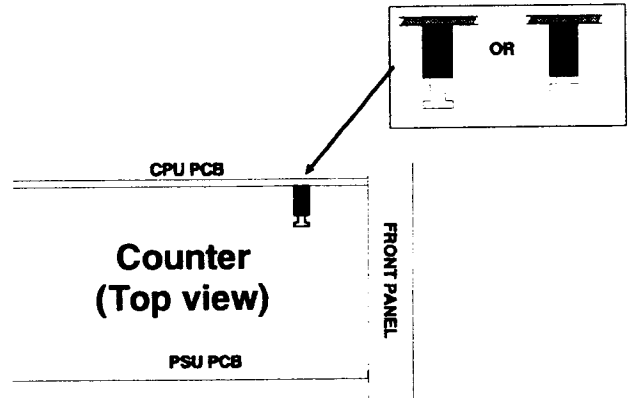

To edit a parameter, use the Down key to step through the parameters; when the desired parameter description is shown in the upper display, press the Next key to enter Edit Mode and to scroll through the available settings. When the desired setting is shown, press the ENT key. The Configuration Mode parameters, in order of appearance, are:

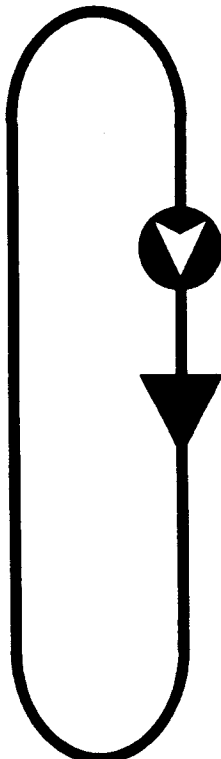

Down key steps through parameters

Parameter	Parameter Description (Upper Display)	Available Settings
Counter Speed		20Hz 200Hz 10kHz
Input Operation		A-B (Add/Subtract) Quadrature (bi-directional)
Panel Reset Key		Enabled Disabled
Auto Reset		Enabled Disabled
Input Pull-Ups		Yes (current-sinking) No (current-sourcing)
Count Direction		Up-counting Down-counting
Lock Strategy		None Preset Lock Partial Program Lock Preset & Program Lock

LOCK STRATEGY:

- None = No security; all parameters available through regular methods of access
- Preset Lock = Preset 1 and Preset 2 become Read Only
- Partial Lock = Output ON times are Read Only
- Both = Operator Mode parameters and Output ON times are Read Only.

To exit Configuration Mode, either momentarily remove power from the Counter or press and hold down the **RST** key for at least two seconds.

APPENDIX A

SPECIFICATIONS

Input Power

AC:	Terminals 7 (Line) and 8 (Neutral) 90 - 264V 50/60Hz (standard) 20 - 50V AC 50/60Hz (option)
DC:	Terminals 7 and 8; 22 - 65V (option)
Power consumption:	4W approx.

Output Power

DC:	Terminals 1 (+) and 4 (COM) 9 - 15V DC (unregulated) 0 - 100mA. $\leq 0.5V$ ripple
-----	--

Main Counter

Decades:	4, Bi-directional
Presets:	2 (4 decades each)
Operation:	Add/Subtract (Input A counts up, Input B counts down) or bi-directional (quadrature; counts up when Signal A leads Signal B).
Direction:	Up (reset-to-zero) or Down (set-to-a-number)
Count Rate	
High:	10kHz max.
Medium:	200Hz max.
Low:	20Hz max.
Resets:	Manual or automatic. Selectable reset-to-zero or reset-to-Preset

Calibrator

Range:	0.001 to 9.999 Common to Inputs A and B.
--------	---

Count Inputs

Signal A:	Terminal 2
Signal B:	Terminal 3
Input Voltage	
High:	$\geq 3.0V$ (source) $\geq 3.0V$ or open (sink)
Low:	$\leq 2.0V$ or open (source) $\leq 2.0V$ (sink)
Max:	30V DC
Input Impedance	
Source:	10k Ω to COM
Sink:	4.7k Ω to + V
Input Response:	0.05ms (high speed)
(Source or sink)	2.5ms (medium speed) 25.0ms (low speed)

Control Inputs

Remote Reset:	Terminal 5 (edge-sensitive)
Program Mode:	Terminal 6 (level-sensitive)
Input Voltage:	High - $\geq 3.0V$ or open Low - $\leq 2.0V$
Input Impedance:	4.7k Ω to + V
Input Response:	25.0ms
Max:	30V DC

Front Panel Keys

Type:	Mechanical switches under sealed membrane overlay.
-------	--

Display

Type:	LED (red) 4 digit
Height:	Upper - 0.4" (10mm) Lower - 0.3" (7mm)

Security

Preset data can be protected (selectable in Configuration Mode).
Program data is accessible only if the PGM input is active.

Output

Operation:	Output 1 energised when: Count = Preset 1
	Output 1 released when: Hold time elapses or reset occurs
	Output 2 energised when: Count = Preset 2 (Up mode) Count = 0 (Down mode)
	Output 2 released when: Hold time elapses or reset occurs

SOLID STATE (OPEN COLLECTOR)

Terminal Nos.:	12 (Preset 1) and 15 (Preset 2)
Type:	Open collector, current sink to COM. 30V DC max. 100mA max.

RELAY

Terminals:	Preset 1: 9 (N/C), 10 (C), 11 (N/O) Preset 2: 16 (N/C), 17 (C), 18 (N/O)
Type:	Form C (SPDT)
Rating:	5A resistive @ 110V AC 3A resistive @ 240V AC

Mechanical

Cut-Out:	45mm x 45mm (V_{16} -DIN)
Depth:	110mm
Weight:	0.2kg approx.

Environmental

Operating Temp.:	0 - 55°C (32 - 131°F)
Storage Temp.:	-20 - 80°C (-4 - 176°F)
Relative Humidity:	20 - 95% non-condensing
Front Panel Seal:	NEMA 4/IP65 when installed with panel gasket (supplied)

WARRANTY/DISCLAIMER

OMEGA ENGINEERING, INC. warrants this unit to be free of defects in materials and workmanship for a period of **13 months** from date of purchase. OMEGA's WARRANTY adds an additional one (1) month grace period to the normal **one (1) year product warranty** to cover handling and shipping time. This ensures that OMEGA's customers receive maximum coverage on each product.

If the unit malfunctions, it must be returned to the factory for evaluation. OMEGA's Customer Service Department will issue an Authorized Return (AR) number immediately upon phone or written request. Upon examination by OMEGA, if the unit is found to be defective, it will be repaired or replaced at no charge. OMEGA's WARRANTY does not apply to defects resulting from any action of the purchaser, including but not limited to mishandling, improper interfacing, operation outside of design limits, improper repair, or unauthorized modification. This WARRANTY is VOID if the unit shows evidence of having been tampered with or shows evidence of having been damaged as a result of excessive corrosion; or current, heat, moisture or vibration; improper specification; misapplication; misuse or other operating conditions outside of OMEGA's control. Components which wear are not warranted, including but not limited to contact points, fuses, and triacs.

OMEGA is pleased to offer suggestions on the use of its various products. However, OMEGA neither assumes responsibility for any omissions or errors nor assumes liability for any damages that result from the use of its products in accordance with information provided by OMEGA, either verbal or written. OMEGA warrants only that the parts manufactured by it will be as specified and free of defects. OMEGA MAKES NO OTHER WARRANTIES OR REPRESENTATIONS OF ANY KIND WHATSOEVER, EXPRESS OR IMPLIED, EXCEPT THAT OF TITLE, AND ALL IMPLIED WARRANTIES INCLUDING ANY WARRANTY OF MERCHANTABILITY AND FITNESS FOR A PARTICULAR PURPOSE ARE HEREBY DISCLAIMED. LIMITATION OF LIABILITY: The remedies of purchaser set forth herein are exclusive, and the total liability of OMEGA with respect to this order, whether based on contract, warranty, negligence, indemnification, strict liability or otherwise, shall not exceed the purchase price of the component upon which liability is based. In no event shall OMEGA be liable for consequential, incidental or special damages.

CONDITIONS: Equipment sold by OMEGA is not intended to be used, nor shall it be used: (1) as a "Basic Component" under 10 CFR 21 (NRC), used in or with any nuclear installation or activity; or (2) in medical applications or used on humans. Should any Product(s) be used in or with any nuclear installation or activity, medical application, used on humans, or misused in any way, OMEGA assumes no responsibility as set forth in our basic WARRANTY/DISCLAIMER language, and, additionally, purchaser will indemnify OMEGA and hold OMEGA harmless from any liability or damage whatsoever arising out of the use of the Product(s) in such a manner.

RETURN REQUESTS/INQUIRIES

Direct all warranty and repair requests/inquiries to the OMEGA Customer Service Department. BEFORE RETURNING ANY PRODUCT(S) TO OMEGA, PURCHASER MUST OBTAIN AN AUTHORIZED RETURN (AR) NUMBER FROM OMEGA'S CUSTOMER SERVICE DEPARTMENT (IN ORDER TO AVOID PROCESSING DELAYS). The assigned AR number should then be marked on the outside of the return package and on any correspondence.

The purchaser is responsible for shipping charges, freight, insurance and proper packaging to prevent breakage in transit.

FOR **WARRANTY** RETURNS, please have the following information available BEFORE contacting OMEGA:

1. Purchase Order number under which the product was PURCHASED,
2. Model and serial number of the product under warranty, and
3. Repair instructions and/or specific problems relative to the product.

FOR **NON-WARRANTY** REPAIRS, consult OMEGA for current repair charges. Have the following information available BEFORE contacting OMEGA:

1. Purchase Order number to cover the COST of the repair,
2. Model and serial number of the product, and
3. Repair instructions and/or specific problems relative to the product.

OMEGA's policy is to make running changes, not model changes, whenever an improvement is possible. This affords our customers the latest in technology and engineering.

OMEGA is a registered trademark of OMEGA ENGINEERING, INC.

© Copyright 1999 OMEGA ENGINEERING, INC. All rights reserved. This document may not be copied, photocopied, reproduced, translated, or reduced to any electronic medium or machine-readable form, in whole or in part, without the prior written consent of OMEGA ENGINEERING, INC.

Where Do I Find Everything I Need for Process Measurement and Control? OMEGA...Of Course!

TEMPERATURE

- Thermocouple, RTD & Thermistor Probes, Connectors, Panels & Assemblies
- Wire: Thermocouple, RTD & Thermistor
- Calibrators & Ice Point References
- Recorders, Controllers & Process Monitors
- Infrared Pyrometers

PRESSURE, STRAIN AND FORCE

- Transducers & Strain Gages
- Load Cells & Pressure Gages
- Displacement Transducers
- Instrumentation & Accessories

FLOW/LEVEL

- Rotameters, Gas Mass Flowmeters & Flow Computers
- Air Velocity Indicators
- Turbine/Paddlewheel Systems
- Totalizers & Batch Controllers

pH/CONDUCTIVITY

- pH Electrodes, Testers & Accessories
- Benchtop/Laboratory Meters
- Controllers, Calibrators, Simulators & Pumps
- Industrial pH & Conductivity Equipment

DATA ACQUISITION

- Data Acquisition & Engineering Software
- Communications-Based Acquisition Systems
- Plug-in Cards for Apple, IBM & Compatibles
- Datalogging Systems
- Recorders, Printers & Plotters

HEATERS

- Heating Cable
- Cartridge & Strip Heaters
- Immersion & Band Heaters
- Flexible Heaters
- Laboratory Heaters

ENVIRONMENTAL MONITORING AND CONTROL

- Metering & Control Instrumentation
- Refractometers
- Pumps & Tubing
- Air, Soil & Water Monitors
- Industrial Water & Wastewater Treatment
- pH, Conductivity & Dissolved Oxygen Instruments