

**YEAR
2000
COMPLIANT**



User's Guide



omega.com[®]
— Ω OMEGA —

http://www.omega.com
e-mail: info@omega.com

CN491A SERIES
1/32 DIN Temperature/Process Controllers



OMEGAnet® On-Line Service
<http://www.omega.com>

Internet e-mail
info@omega.com

Servicing North America:

USA: ISO 9001 Certified
One Omega Drive, Box 4047
Stamford, CT 06907-0047
Tel: (203) 359-1660
FAX: (203) 359-7700
e-mail: info@omega.com

Canada:
976 Bergar
Laval (Quebec) H7L 5A1
Tel: (514) 856-6928
FAX: (514) 856-6886
e-mail: info@omega.ca

For immediate technical or application assistance:

USA and Canada:
Sales Service: 1-800-826-6342 / 1-800-TC-OMEGASM
Customer Service: 1-800-622-2378 / 1-800-622-BESTSM
Engineering Service: 1-800-872-9436 / 1-800-USA-WHENSM
TELEX: 996404 EASYLINK: 62968934
CABLE: OMEGA

Mexico and Latin America:
Tel: (95) 800-826-6342
FAX: (95) 203-359-7807
En Español: (95) 203-359-7803
e-mail: espanol@omega.com

Servicing Europe:

Benelux:
Postbus 8034, 1180 LA Amstelveen
The Netherlands
Tel: (31) 20 6418405 FAX: (31) 20 6434643
Toll Free in Benelux: 0800 0993344
e-mail: nl@omega.com

Czech Republic:
ul. Rude armady 1868, 733 01 Karvina-Hranice
Tel: 420 (69) 6311899 FAX: 420 (69) 6311114
Toll Free: 0800-1-66342
e-mail: czech@omega.com

France:
9, rue Denis Papin, 78190 Trappes
Tel: (33) 130-621-400 FAX: (33) 130-699-120
Toll Free in France: 0800-4-06342
e-mail: france@omega.com

Germany/Austria:
Daimlerstrasse 26, D-75392
Deckenpfronn, Germany
Tel: 49 (07056) 3017 FAX: 49 (07056) 8540
Toll Free in Germany: 0130 11 21 66
e-mail: info@omega.de

United Kingdom: ISO 9002 Certified
One Omega Drive
River Bend Technology Centre
Northbank, Irlam
Manchester, M44 5EX, England
Tel: 44 (161) 777-6611
FAX: 44 (161) 777-6622
Toll Free in the United Kingdom: 0800-488-488
e-mail: info@omega.co.uk

It is the policy of OMEGA to comply with all worldwide safety and EMC/EMI regulations that apply. OMEGA is constantly pursuing certification of its products to the European New Approach Directives. OMEGA will add the CE mark to every appropriate device upon certification.

The information contained in this document is believed to be correct, but OMEGA Engineering, Inc. accepts no liability for any errors it contains, and reserves the right to alter specifications without notice.

WARNING: These products are not designed for use in, and should not be used for, patient-connected applications.

TABLE OF CONTENTS

Introduction	2
Fuzzy Logic	2
Specifications	4
Input Range	5
Model Configuration	6
Installation	7
Wiring & Mounting	7
Negotiating the menu	11
Learning the parameters	12
Primary Program Menu	16
Changing Setpoint	17
Begin Controlling	17
Flow Chart of Parameters	18
Auto-tuning	20
Alarms	21
Setting Alarms	23
Scaling Analog Inputs/Setting Setpoint Limits	24
Ramp Function	26
Ramp & Soak/Dwell Function	27
Tool Program Menu	29
Flow Chart of Tool Programs	30
Manual Control	32
Programmable Control Action	33
Cooling Control	34
Configurable Menus	35
Locking Menus	37
Error Messages	38

INTRODUCTION

General Description

The CN491A is a fully programmable, microprocessor-based temperature/process controller. It offers superior control with 200 msec sampling rate and by using fuzzy logic to enhance its P, I and D parameters. The 4-digit 0.4" red LED display offers excellent visibility on a unit that is 1/32 DIN in size.

The CN491A is available with either 20-32V AC/DC or 90-264V AC power supply. This is a single universal input unit that will accept 8 different thermocouple types, Pt100 RTDs, and a variety of linear mA and VDC signals. The wide range of options for the two available outputs include relays, SSR drives, 4-20mA, 0-20mA, or 0-10VDC. Output #1 can be used in either a direct or reverse action control situation with a programmable ramp rate. Output #2 can be used as a control output, as an alarm, or as a dwell timer.

Optional features include 2-wire RS-485 serial communications with Windows 95™-based software, and Analog Retransmission of process variable, setpoint variable or the percentage of control output, as a 0-20 mA/4-20 mA DC signal.

The communications software package, CN491A-SOFT, offers excellent graphics, bar and trend displays, and supports easy-to-use database control and back-up capability.

FUZZY LOGIC

The function of Fuzzy Logic is to adjust the PID parameters internally in order to make the control output more flexible and adaptive to the process. One of the best analogies would compare Fuzzy Logic to the abilities of a good driver. The driver is

able to control a car well at a variety of speeds and under varying circumstances by using knowledge gained through previous experience.

Fuzzy Logic combined with PID control has been proven to be an efficient method to improve control stability. This is illustrated in figure 3.

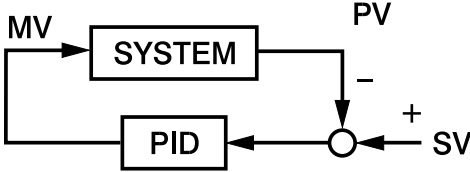

Figure 1. PID only

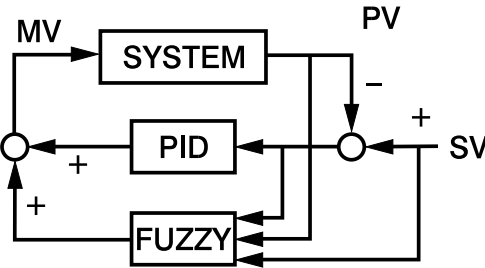

Figure 2. PID with fuzzy logic

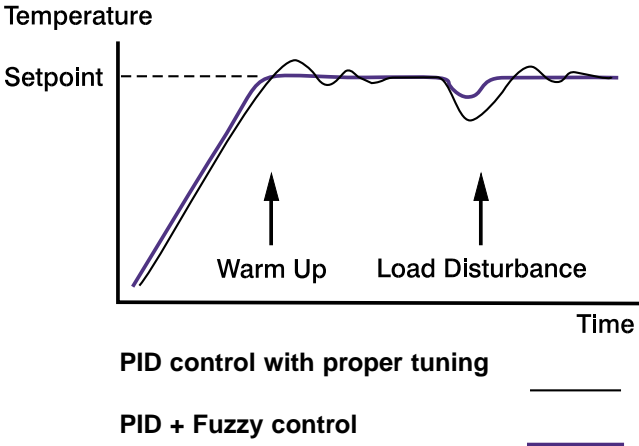

Figure 3. PID vs. PID and fuzzy logic

SPECIFICATIONS

INPUT

Thermocouple(T/C):	Type J,K,T,E,B,R,S,N
RTD:	Pt100 ohm RTD (DIN 43760/BS 1904 or JIS)
Linear:	Scalable. Refer to table on p.5
Range:	User configurable, refer to table on p.5
Accuracy:	Refer to table on p.5
Cold-Junction Compensation:	0.1°C / °C ambient (typical)
External Resistance:	100 ohm max.(for thermocouple)
Normal Mode Rejection:	60dB
Common Mode Rejection:	120dB
Sample Rate:	200 msec

CONTROL

Proportional Band:	0-360°F, 0-200°C, 0-3600 Process Units
Reset (Integral):	0-3600 seconds
Rate (derivative):	0-1000 seconds
Ramp rate:	0-55.55°C/min, 0-99.99°F/min, 0-99.99 Process Units(P.U.)/min
Dwell:	0-9999 minutes
Hysteresis:	0.1-11.0°C, 0.1-19.9°F, 0.1-199 P.U.
Cycle Time:	0-99 seconds
Control Action:	Direct (cooling) and reverse(heating)

OUTPUT

Relay:	3A/240 VAC (resistive)
DC pulse:	24 VDC/20 mA max.
4 to 20 mA:	Linear, max. load 500 ohms
0 to 20 mA:	Linear, max. load 500 ohms
0 to 10 V:	Linear, min. input impedance 500K ohms

INDICATION

Process Display:	0.4" red LED, 4 digits
Status Indicator:	Control output and alarm

POWER

Rating: 90-264VAC nominal, 264V excursion (max)
50/60Hz or 20-32V AC/DC

Consumption: Less than 5VA

ENVIRONMENTAL & PHYSICAL

Safety: CE & CSA Approved, & UL Recognized

Protection: NEMA 4X (indoor use), IP65

Operating Temperature: -10 to 50°C (14 to 122°F)

Humidity: 0 to 90%RH (non-condensing)

Insulation: 20 Mohm min. (500 VDC)

Breakdown: AC2000V. 50/60Hz. 1 minute

Vibration: 10-55Hz. amplitude 1mm

Shock: 200 m/s² (20g)

Weight: 110 grams

Dimension: 24(H) x 48(W) x 99mm (depth behind panel)

Panel cutout: 22.2mm(H) (+.3/-0) 45 mm(W) (+.5/-0)

RANGE AND ACCURACY OF INPUTS

SENSOR	INPUT TYPE	RANGE (°F)	RANGE (°C)	ACCURACY
J	Iron-Constantan	-58 to 1830	-50 to 999	±3.6°F/±2°C
K	CHROMECA®-ALOMEGA®	-58 to 2500	-50 to 1370	±3.6°F/±2°C
T	Copper-Constantan	-454 to 752	-270 to 400	±3.6°F/±2°C
E	CHROMECA®-Constantan	-58 to 1382	-50 to 750	±3.6°F/±2°C
B	Pt30%Rh/Pt6%Rh	572 to 3272	300 to 1800	±3.6°F/±2°C
R	Pt13%Rh/Pt	32 to 3182	0 to 1750	±3.6°F/±2°C
S	Pt10%Rh/Pt	32 to 3182	0 to 1750	±3.6°F/±2°C
N	Nicrosil-Nisil	-58 to 2372	-50 to 1300	±3.6°F/±2°C
RTD	Pt100 ohm (DIN)	-328 to 842	-200 to 450	±0.72°F/±0.4°C
RTD	Pt100ohm (JIS)	-328 to 842	-200 to 450	±0.72°F/±0.4°C

LINEAR INPUTS (All scalable)

Input type	Range	Accuracy
4-20 mA, 0-20 mA, 0-1V, 0-5V, 1-5V, 0-10V	-1400 to 9400	±0.05% FS

CN491A MODEL CONFIGURATION

Model No	Description
CN491A-R1	Relay Output
CN491A-D1	DC Pulse Output
CN491A-F1A	4-20mA Output
CN491A-F1B	0-20mA Output
CN491A-V1	0-10V Output

SECOND OUTPUT/ALARM

Suffix	Description
-R2	Relay
-D2	DC pulse
-F2A	4-20mA
-F2B	0-20mA
-V2	0-10V

AUXILIARY OPTIONS

Suffix	Description
-C4	RS-485 Communications
-PVSV	0-20mA/4-20mA retransmission

OPTIONAL POWER SUPPLY

Suffix	Description
-LV	20-32V AC/DC

INSTALLATION

MOUNTING

Install mounting clamp(s). Gently tighten clamp until the controller fits snugly against the front panel.

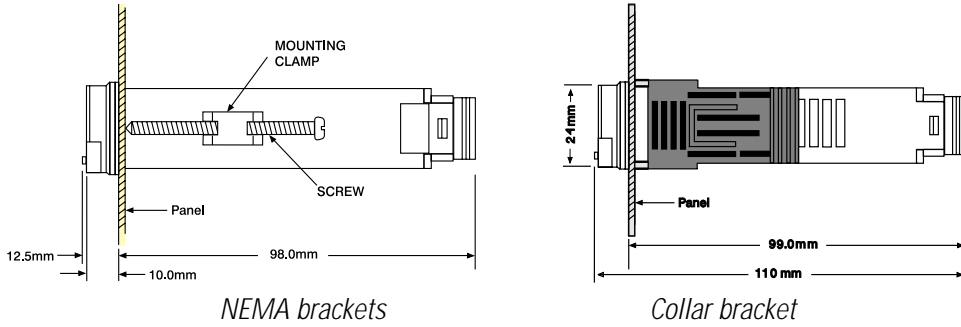

Make panel cutout as shown in figure

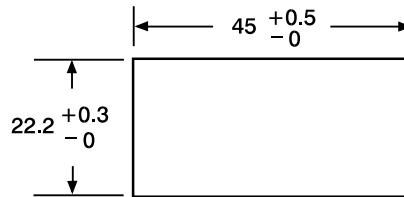

1/32 DIN

WIRING

The following connections for outputs and inputs are provided on the wiring diagram located at the rear of the housing:

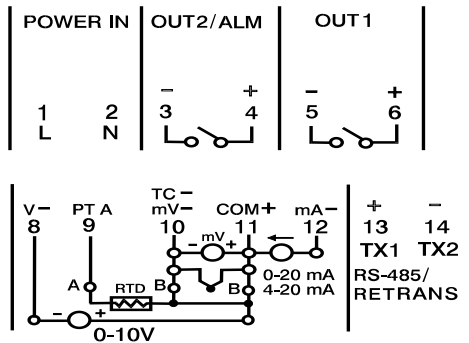

Rear Terminal Connections

POWER SUPPLY

The controller is supplied to operate on either 90-264V AC or 20-32V AC/DC. Check that the supply voltage corresponds to that indicated on the product label before connecting power to the controllers.

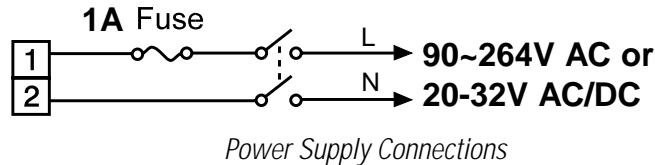

This equipment is designed for installation in an enclosure which provides adequate protection against electric shock. The enclosure must be connected to earth ground.

THERMOCOUPLE INPUT

Thermocouple input connections are shown in the illustration below. The thermocouple extension wire must be of proper type and gauge, and should be run in a conduit, separate from any power wiring. The resistance of the entire run should not exceed 100Ω.

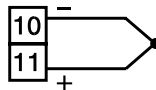

Thermocouple Input Connections

Pt100 Ohm RTD INPUT

RTD connections are shown in the illustration below with the compensating lead connected to terminal 11. For two-wire RTD inputs, terminals 10 and 11 should be linked.

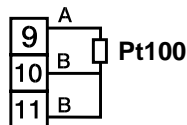

RTD input Connections

DC LINEAR INPUT

DC linear voltage and current input connections are shown below.

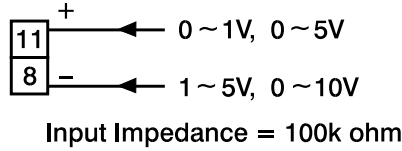

VDC

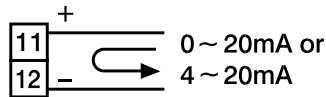

mADC

RELAY OUTPUT DIRECT DRIVE

The illustration below shows connections for using the internal relay to drive a small load. The current should not exceed 3 amps.

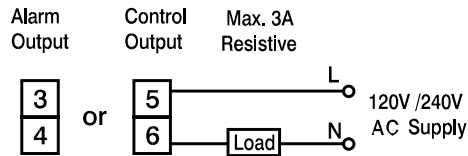

Relay Direct Drive Connections

RELAY OUTPUT CONTACTOR DRIVE

The illustration below shows connections for using an external relay to drive heavier loads.

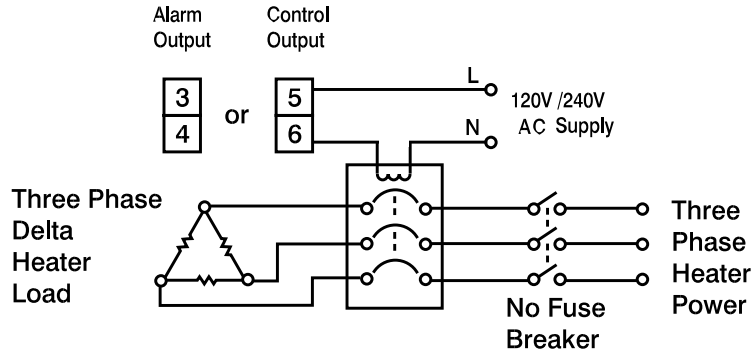

Relay Contactor Drive Connections

DC PULSE (SOLID-STATE RELAY DRIVE) OUTPUT

Controllers fitted with the DC pulse output produce a time-proportional non-isolated pulse voltage (0-24V nominal, output impedance 660Ω). The connections are shown in the illustration below.

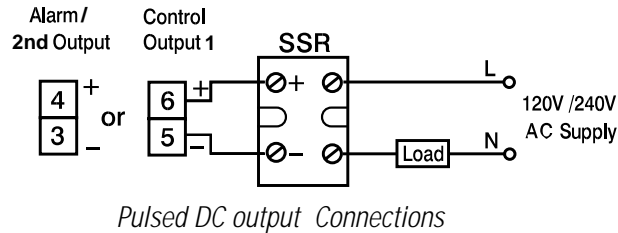

DC LINEAR OUTPUT

There are three types of linear output modules that can be selected for the output. The connections are shown in the illustration below.

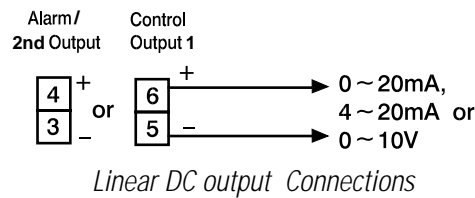

RS-485 COMMUNICATIONS/ANALOG RETRANSMISSION

RS-485 serial communications or Analog retransmission of process variable, setpoint, or manipulated variable can be selected as an optional feature. The connections are shown in the illustration below.

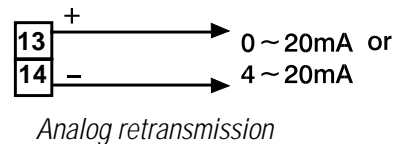

NEGOTIATING THE CN491A MENU

When the controller is powered up it automatically displays the Process Variable (PV).

From the Process Variable (PV) display you can easily:

Press either the  or  key momentarily to view set-point.















or

Press the  key momentarily to enter the Primary Program Menu.

or

Press the  key and the  key simultaneously to enter the Tool Program Menu.



TOUCH KEYS	FUNCTION	DESCRIPTION
	Up key	Press to select digit to change. Press and hold to increase value for parameter
	Down key	Press to select digit to change. Press and hold to decrease value for parameter
	Scroll key	Press to select parameter in direct sequence or to select tool program parameters
 press for 3.2 seconds	Long scroll/ Enter key	Use to select protected parameters in higher security level or to actuate selected tool program
 & 	Reverse scroll/ Calibration Verification	Use to select parameter in reverse sequence or to verify display accuracy for input types during calibration
 &  press for 3.2 seconds	Lock key	Use to disable keypad operation to protect parameters
 & 	Tool program key	Press to select tool program in sequence
 & 	Reset/Exit key	Press to unlock keypad operation, to reset display, to exit tool program, or to end autotune and manual control execution.
 &  press for 3.2 seconds	Autotune key	Hold both keys for 3.2 seconds then release to start autotune.

LEARNING THE PARAMETERS

- SV** **SV - Setpoint**
This parameter is the target value for the process. It can be adjusted throughout the range defined by the Low Scale Value *LoSC* and High Scale Value *HiSC*. Set in degrees/engineering units.
- ASP.1** **ASP1 - Alarm 1 Setpoint or Dwell Time**
If output #2 is configured as an alarm this parameter sets the point that the alarm will be activated. If output #2 is configured as a Dwell Timer this parameter sets the amount of time to be counted. Set in degrees/engineering units for alarms or minutes for timer.
- rRnP** **Ramp - Ramp Rate**
This determines the rate at which your process will approach setpoint. Setting this parameter to 0 will cause your system to approach setpoint at maximum speed. Set in degrees/minute.
- oFSt** **OFST - Offset Value for Manual Reset**
For systems using proportional control only (Ti set to 0) this parameter will be adjusted to compensate for any deviation between setpoint and process. Set 0-100% of Pb.
- Sh, F** **SHIF - Shift Process Value**
This value will be added to the process value to correct for errors or to synchronize a number of different units. Set in degrees/engineering units.
- Pb** **PB - Proportional Band**
The proportional band is that area around main setpoint where the control output is neither full on nor full off.
- hYST** **HYST - Hysteresis for ON/OFF Control**
The hysteresis for output #1 is the area around the main setpoint where the output does not change condition. It is intended to eliminate relay chatter at setpoint for ON/OFF control applications.
-

t_i **TI - Integral Time**

The integral time is the speed at which a corrective increase or decrease in output is made to compensate for offset which usually accompanies proportional only processes. The more the integral time entered, the slower the action. The less the integral time entered, the faster the action. Enter a value that would eliminate offset without overcompensation, resulting in process oscillation.

 t_d **TD - Derivative Time**

The derivative time is that time used in calculating rate of change and thermal lag in helping eliminate overshoot which results in response to process upsets. This overshoot usually accompanies proportional only and proportional integral processes. The derivative action dampens proportional and integral action as it anticipates where the process should be. The more the derivative time entered, the more the damping action. The less the derivative time entered, the less damping action. Enter as much derivative time as necessary to eliminate overshoot without overdamping the process resulting in process oscillation.

 $Addr$ **ADDR - Address of unit for serial communications/ Retransmission**

This unit can be assigned a numerical address to identify it as one of 191 stations on an RS-485 serial communications loop (set from 1-191) or for 4-20mA/0-20mA retransmission (set from 192-199).

Code for "Addr"	Retransmission
192	4~20mA, PV
193	4~20mA, SV
194	4~20mA, MV1 (Output 1)
195	4~20mA, MV2 (Output 2)
196	0~20mA, PV
197	0~20mA, SV
198	0~20mA, MV1 (Output 1)
199	0~20mA, MV2 (Output 2)

LoSC

LOSC/HISC - Low/High Scale Range

HiSC

If a thermocouple or RTD is being used these parameters will establish the allowable range for the setpoint. If an analog input is being used these parameters will establish the scaling range for the process signal and the allowable range for the setpoint. Set in temperature/engineering units.

PL.1

PL1/PL2 - Power Limit for Heating and Cooling Outputs

PL.2

These parameters limit the maximum percentage of power for the control outputs. These are used on systems that cannot tolerate 100% power. Set from 0-100%.

INPt

INPT - Input Type Selection

Used to indicate what type of sensor input will be connected. See Range and Accuracy of Inputs on page 5 for available input types.

UNIT

UNIT - Process Unit

Used to select the correct engineering units for the process. (PU for Analog inputs, C or F for temperature applications).

RESO

RESO - Decimal Point Resolution

This parameter defines the position of the decimal point for the process value and setpoint value. Set to 0, 1 or 2 positions right of the decimal point. (2 positions is reserved for linear inputs only.)

CONA

CONA - Control Action of Output #1

Determines whether the output will be reverse acting, as in a heating application, or direct, as in a cooling application. See programmable control action on page 33.

AlMd

A1MD - Alarm Mode Selection for Alarm #1

Refer to page 22 for the various alarm types available.

A 1SF

A1SF - Alarm #1 Special Function

Selects a hold function or latch function for alarm #1. Also, used to reconfigure alarm #1 as a dwell timer. Refer to page 22 for more information. Set to **COOL** for cooling action on output #2.

CYC

CYC/CCYC - Proportional Cycle Time for Outputs #1 & #2

CCYC

These parameters determine the duration of the duty cycle for time proportioned outputs. Set from 0-99 seconds. Set to 0 for linear outputs.

CPb

CPB/DB - Cooling Proportional Band/Dead Band

d-b



Used only when output #2 is configured for cooling applications. Refer to page 34 for a more detailed explanation.

PRIMARY PROGRAM MENU

Press the  key momentarily to enter the Primary Program Menu.

Press the  key momentarily to scroll through the Primary Program Menu.

Pause momentarily on a parameter to be changed. After 3.2 sec the display will begin to toggle between the parameter and its current value.

Press either the  or  key momentarily to highlight the numerical position to be changed.

Press and hold either the  or  key to increment or decrement the desired position.



Press the  key momentarily to continue scrolling through the Primary Program Menu.

When you've reached the last parameter in a given level, press and hold the  key until that parameter stops flashing. This will advance you to the next level of the Primary Program Menu.

CHANGING SETPOINT (SV)

Press either the  or  key momentarily to view set-point

Press either the  or  key momentarily to highlight the numerical position to be changed.

Press and hold either the  or  key to increment or decrement the desired position.

After approximately 10 seconds the unit will automatically return to reading the Process Variable (PV).

BEGIN CONTROLLING

1. Insure that the controller is properly wired for your application. As soon as the unit is powered up it will begin trying to control at the current setpoint.
2. Check the display of the controller. Make sure that it is reading the actual temperature/engineering units.
3. If everything looks correct set the desired setpoint, go to the auto-tune procedure (page 20) and initiate it. When autotune is complete your system will be ready.
4. If you experience problems go to the troubleshooting section (p.38).

FLOW CHART OF PARAMETERS

The following chart shows a typical (default) access sequence of parameters.

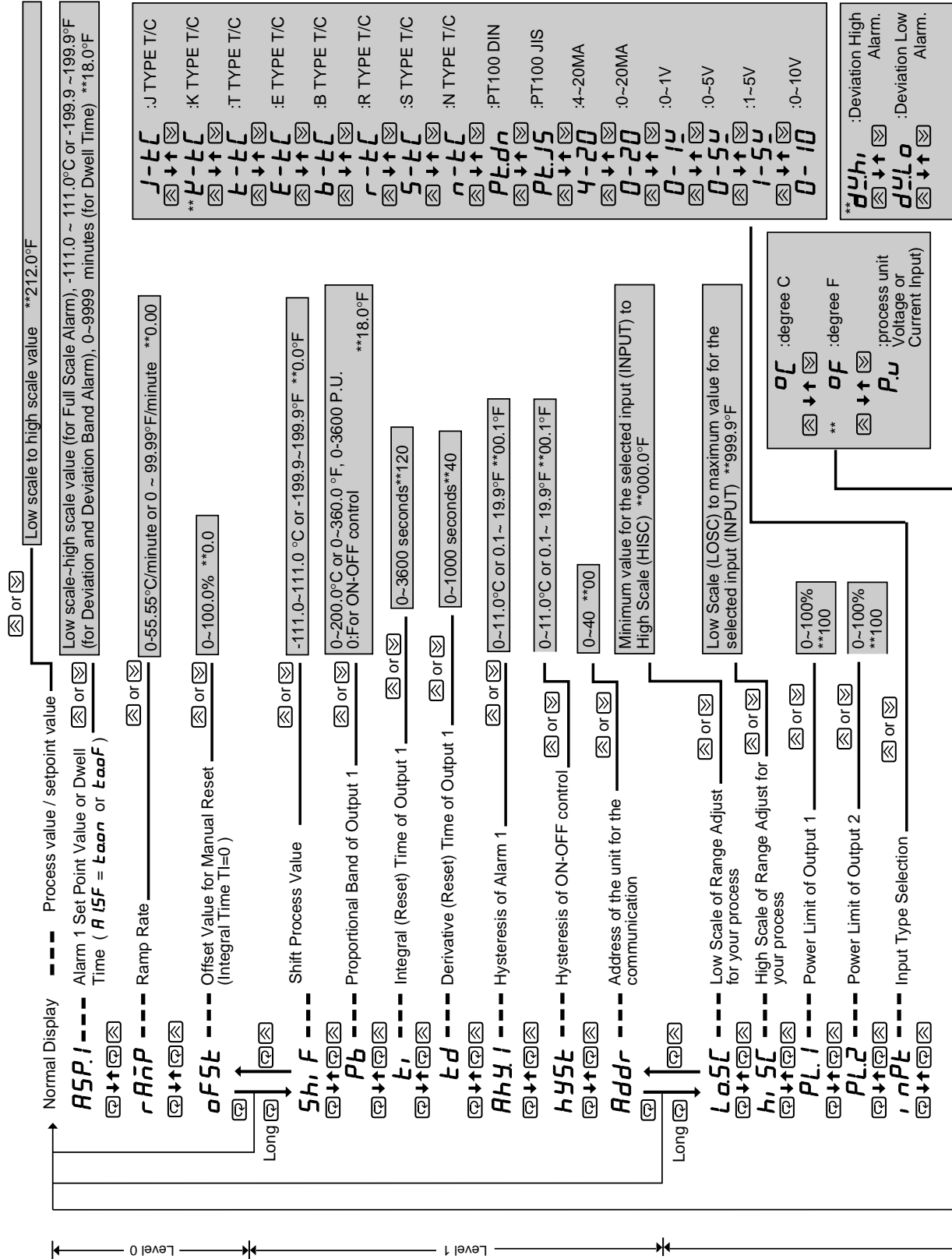

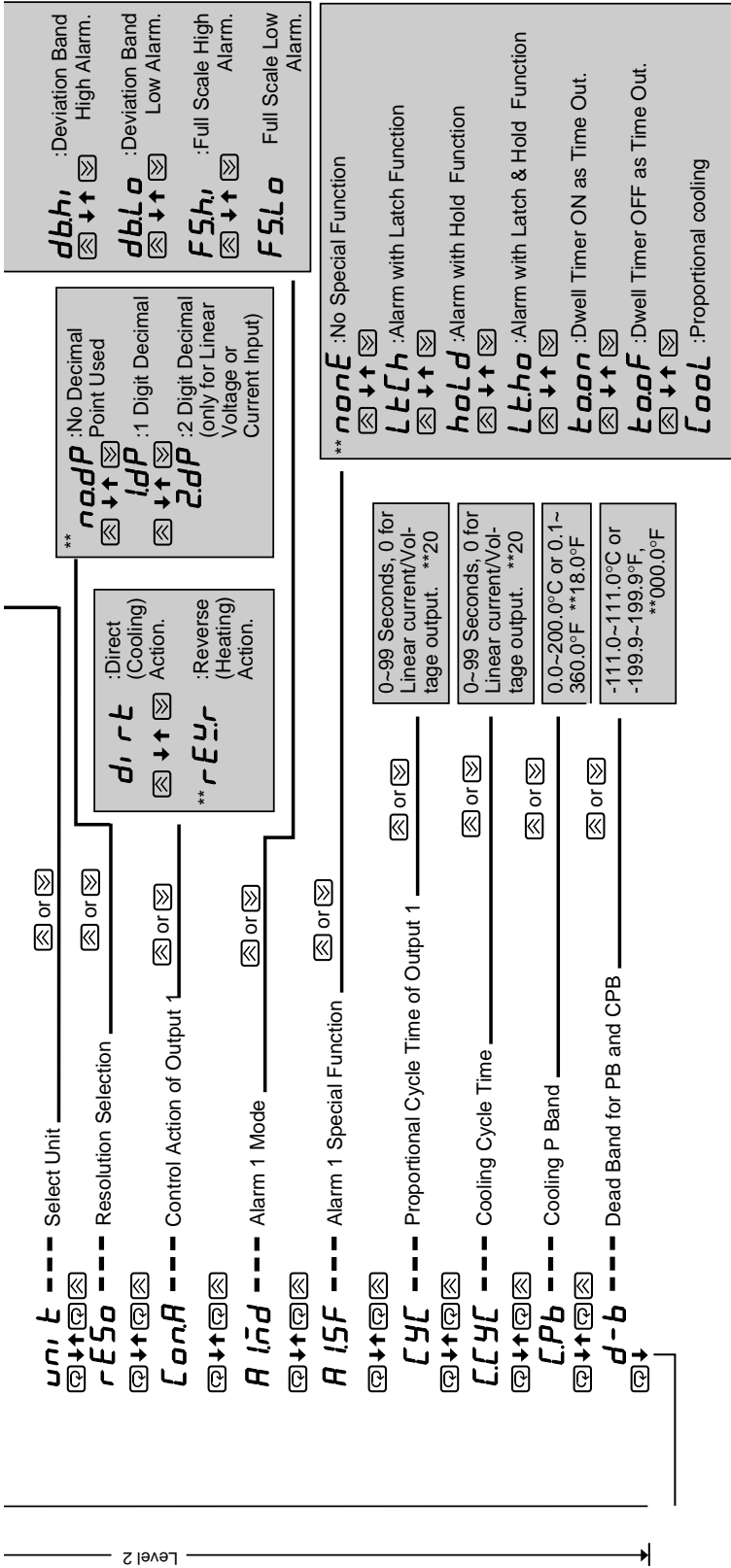

Note: Using the Tool Program the display sequence and the security level for any parameter are configurable. Also, any unused parameter can be removed from the display sequence to simplify the operation.

** : Denotes the default setting

Long : Press and hold for at least 3.2 seconds



AUTO-TUNING



Auto-tune is a procedure that will oscillate your process around setpoint twice, testing the dynamics of your system and automatically setting the P, I, and D parameters.

You should auto-tune your system:

- during initial set-up.
- if setpoint is changed by a large amount.
- if sensor or output is changed.

TO COMPLETE THE AUTO-TUNE PROCEDURE;

1. Make sure all parameters are configured correctly.
2. Have system under normal load conditions.
3. Make sure Pb(Proportional band) is not 0.
4. Set the setpoint to the normal operating temperature.
Note: If system overshoot is likely to cause damage, reduce the setpoint during autotune.
5. Press and hold the  and  keys for 3.2 seconds and then release. The display will begin flashing and will continue to flash throughout the auto-tune process.

Note: To abort the autotune process, press and release the  and  keys during the first oscillation of the process.

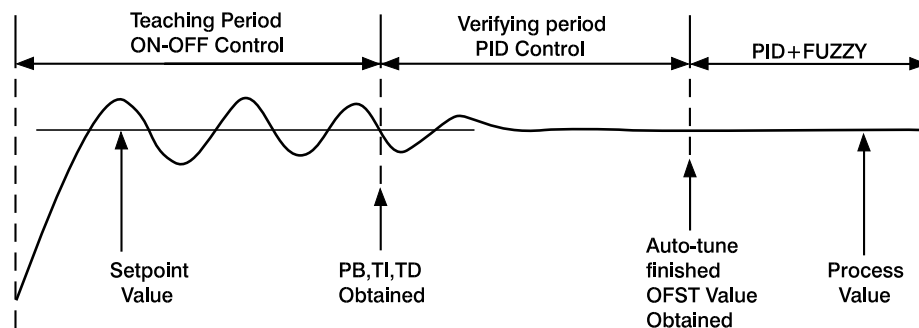

ALARMS

This controller is available with a second output that can be configured for a variety of alarm types. The following parameters in the Primary Program Menu are used to configure the alarms;

ASP.1 **Alarm 1 setpoint** - This parameter determines the point that alarm 1 will be activated.

Example: Deviation high alarm with no special function
 $SV = 100^{\circ}\text{C}$, $ASP1 = 10^{\circ}\text{C}$, $AHY1 = 4^{\circ}\text{C}$

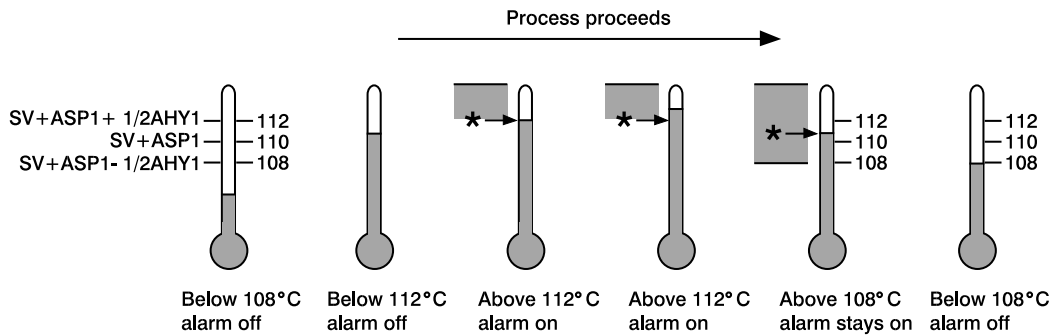

AHY.1 **Alarm 1 Hysteresis** - This parameter establishes an area around Alarm 1 setpoint where the alarm relay will not change states.

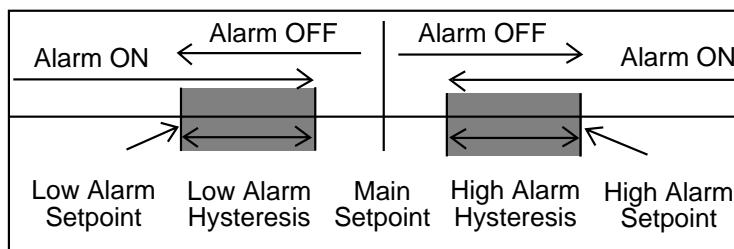

Alnd **Alarm 1 mode** - This parameter determines the alarm type that is to be used, such as a deviation alarm, a band alarm, or an absolute alarm.

Code	Type		
1	Full scale high	FSh i	
2	Full scale low	FSLo	
3	Deviation high	dUh i	
4	Deviation low	dULo	
7	Deviation band high	dbh i	
8	Deviation band low	dbLo	

AlSF **Alarm 1 Spec. Func.**- This parameter assigns special functions to Alarm 1 such as a **holding** feature **hold** that prevents an alarm during start up or a **latch** function **LECh** that prevents the alarm from clearing unless power is interrupted.

Example: Deviation low alarm with Hold function.

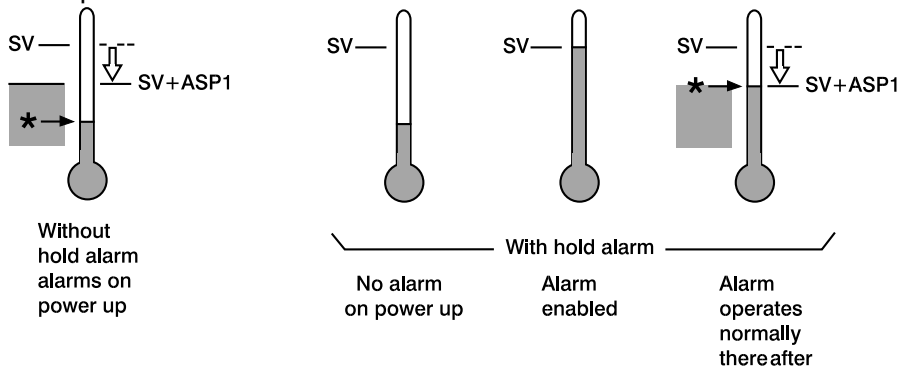



SETTING ALARMS

To set an alarm:

Press the  key momentarily to enter the Primary Program Menu.



Press the  key momentarily to scroll through the Primary Program Menu until you come to **A lnd** .

Pause momentarily. After 3.2 sec the display will begin to toggle between **A lnd** and its current setting.

Press and hold either the  or  key to select the desired alarm type.



Press the  key momentarily to continue scrolling through the Primary Program Menu until you come to **A ISF** .



Pause momentarily. After 3.2 sec the display will begin to toggle between **A ISF** and its current setting.

Press and hold either the  or  key to select the desired alarm special function.

Press the  key momentarily to continue scrolling through the Primary Program Menu until you come to **ASP.1** .



Pause momentarily. After 3.2 sec the display will begin to toggle between **ASP.1** and its current setting.



Press either the  or  key momentarily to highlight the numerical position to be changed.

Press and hold either the  or  key to select the desired alarm set point.

Press the  key momentarily to continue scrolling through the Primary Program Menu until you come to **AhY.1** .

Pause momentarily. After 3.2 sec the display will begin to toggle between **AhY.1** and its current setting.

Press either the  or  key momentarily to highlight the numerical position to be changed.

Press and hold either the  or  key to select the desired amount of alarm hysteresis.

SCALING ANALOG INPUTS / SETTING SETPOINT LIMITS

When an analog input such as 4-20 mA signal is applied to this unit it is necessary to tell the unit how this signal is to be scaled.

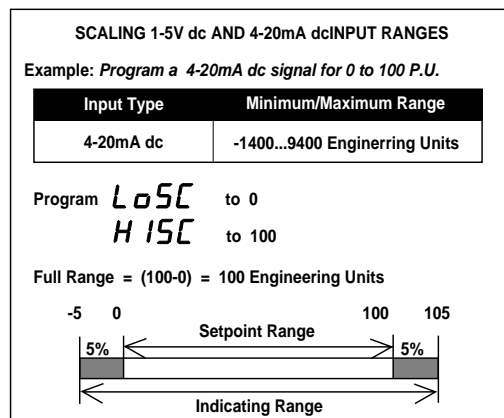

When a thermocouple or RTD is applied to this controller it may be necessary to establish limits that the setpoint can be set within in order to protect the system from over/ under-temperature situations.

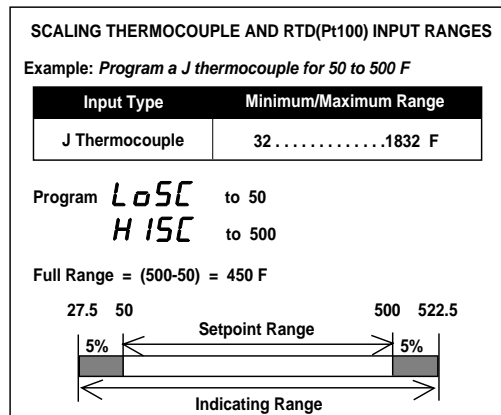

Parameters **LoSC** (zero point/lower setpoint limit) and **HiSC** (span point/upper setpoint limit) are used to scale analog inputs or to establish setpoint limits.

TO SET THESE PARAMETERS;

Press the key momentarily to enter the Primary Program Menu.

Press the key momentarily to scroll through the Primary Program Menu until you come to **LoSC** / **HiSC** .

Pause momentarily. After 3.2 sec the display will begin to toggle between **LoSC** / **HiSC** and its current setting.

Press either the or key momentarily to highlight the numerical position to be changed.

Press and hold either the or key to enter the desired value.

RAMP FUNCTION

If the ramp function is enabled the process will increase or decrease, during initial power up and setpoint changes, at a rate determined by the parameter $rA\bar{n}P$ which can be adjusted in units/minute. This function will be disabled when $rA\bar{n}P$ is set to zero.

TO SET A RAMP RATE;

Press the $\left[\curvearrowright \right]$ key momentarily to enter the Primary Program Menu.

Press the $\left[\curvearrowright \right]$ key momentarily to scroll through the Primary Program Menu until you come to $rA\bar{n}P$.

Pause momentarily. After 3.2 sec the display will begin to toggle between $rA\bar{n}P$ and its current value.

Press either the $\left[\blacktriangle \right]$ or $\left[\blacktriangledown \right]$ key momentarily to highlight the numerical position to be changed.

Press and hold either the $\left[\blacktriangle \right]$ or $\left[\blacktriangledown \right]$ key to increment or decrement the desired position.

Press the $\left[\curvearrowright \right]$ key momentarily to continue scrolling through the Primary Program Menu.

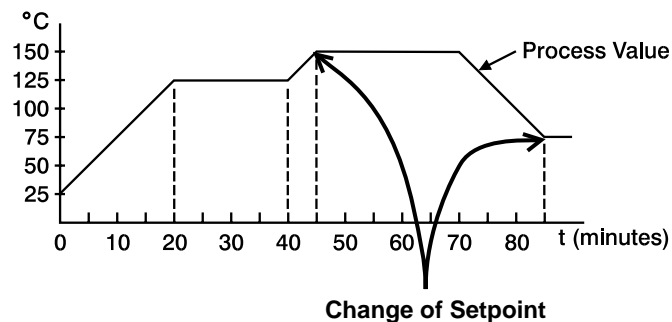

RAMP & SOAK/DWELL FUNCTION

A dwell timer has been incorporated into this controller.

Alarm #1 can be configured by setting **A1SF** = **t00n** or **t00F** to provide either a dwell function or a soak function to be used in conjunction with the ramp function.

The ramp and soak function will allow the system to be programmed to approach setpoint at a specific ramp rate, hold the setpoint temperature for a set amount of time and then shut off the alarm relay. When the output is wired in series with the alarm relay, the output will turn off when the alarm relay shuts off. This will end the soak cycle and return the process to ambient conditions until the controller is reset.

TO SET A SOAK/DWELL TIME

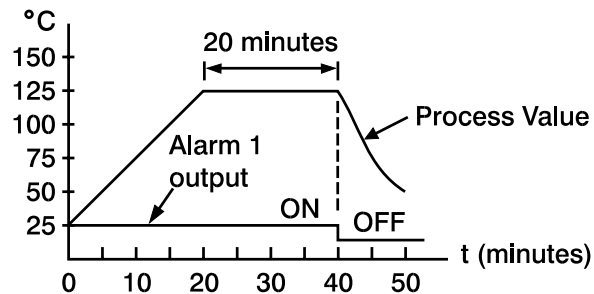









Follow the procedure outlined in Ramp Function to set a ramp rate.

While in the Primary Program Menu continue to scroll until you come to parameter **A1SF**.



Pause momentarily. After 3.2 sec the display will begin to toggle between **A1SF** and its current value.

continued on page 28

Press and hold either the  or  key to increment or decrement to the desired position,  to turn the relay on after the amount of time defined by  or  to turn the relay off after the amount of time defined by .

Press the  key momentarily to continue scrolling through the Primary Program Menu until you come to parameter .

Pause momentarily. After 3.2 sec the display will begin to toggle between  and its current value.

Press either the  or  key momentarily to highlight the numerical position to be changed.

Press and hold either the  or  key to increment or decrement the desired time setting.



TOOL PROGRAM MENU



Press the  key and the  key simultaneously to enter the Tool Program Menu.

Press the  key and the  key simultaneously to scroll through the main headings of the Tool Program Menu.

Press the  key to access the parameters under each main heading within the Tool Program Menu.

Pause momentarily on a parameter to be changed. After 3.2 sec the display will begin to toggle between the parameter and its current value.

Press either the  or  key momentarily to highlight the numerical position to be changed.

Press and hold either the  or  key to increment or decrement the desired position.

Press the  key momentarily to continue scrolling through the parameters within that heading,

or

Press the  key and the  key simultaneously to continue scrolling through the main headings of the Tool Program Menu.

Flow Chart of Tool Programs

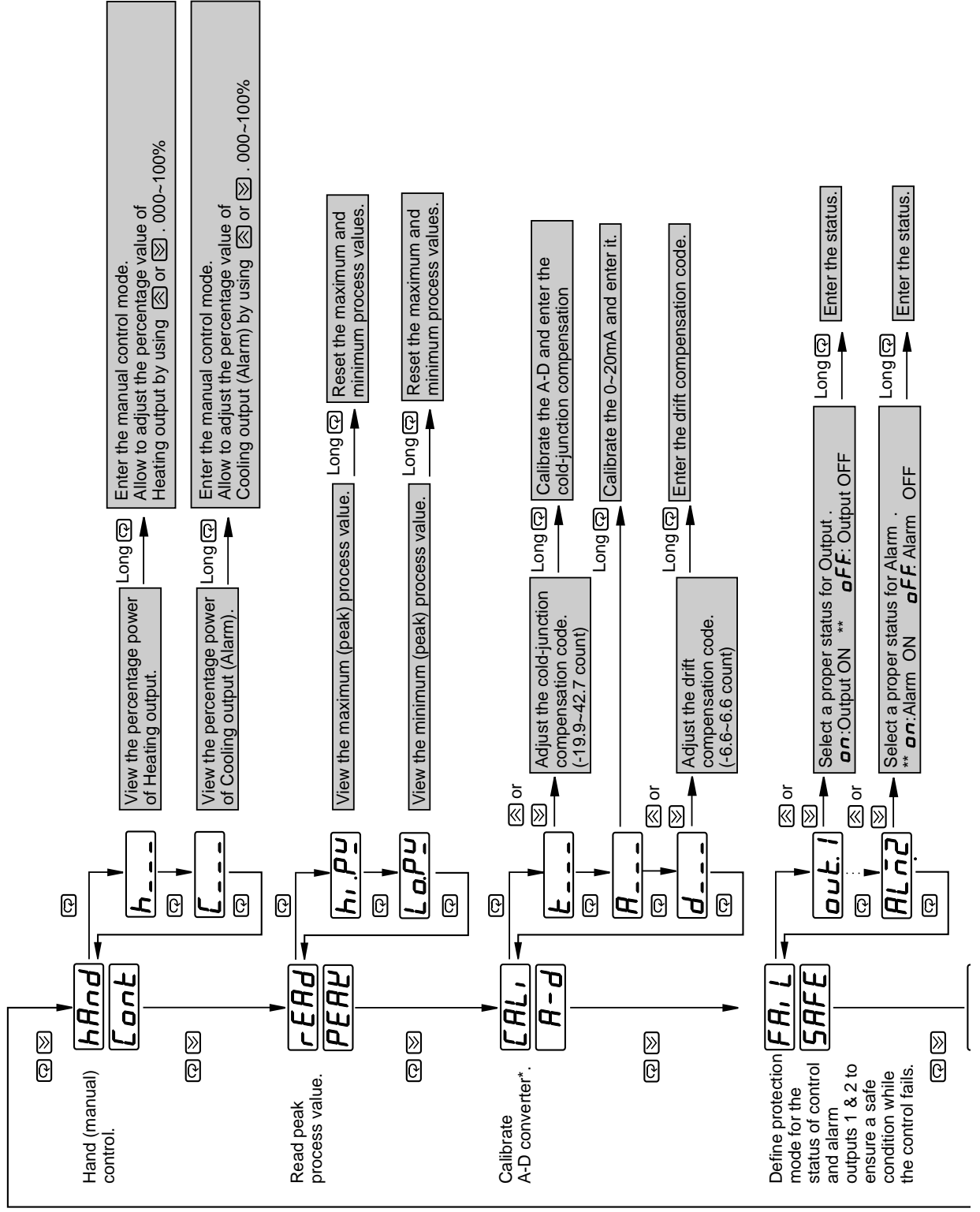

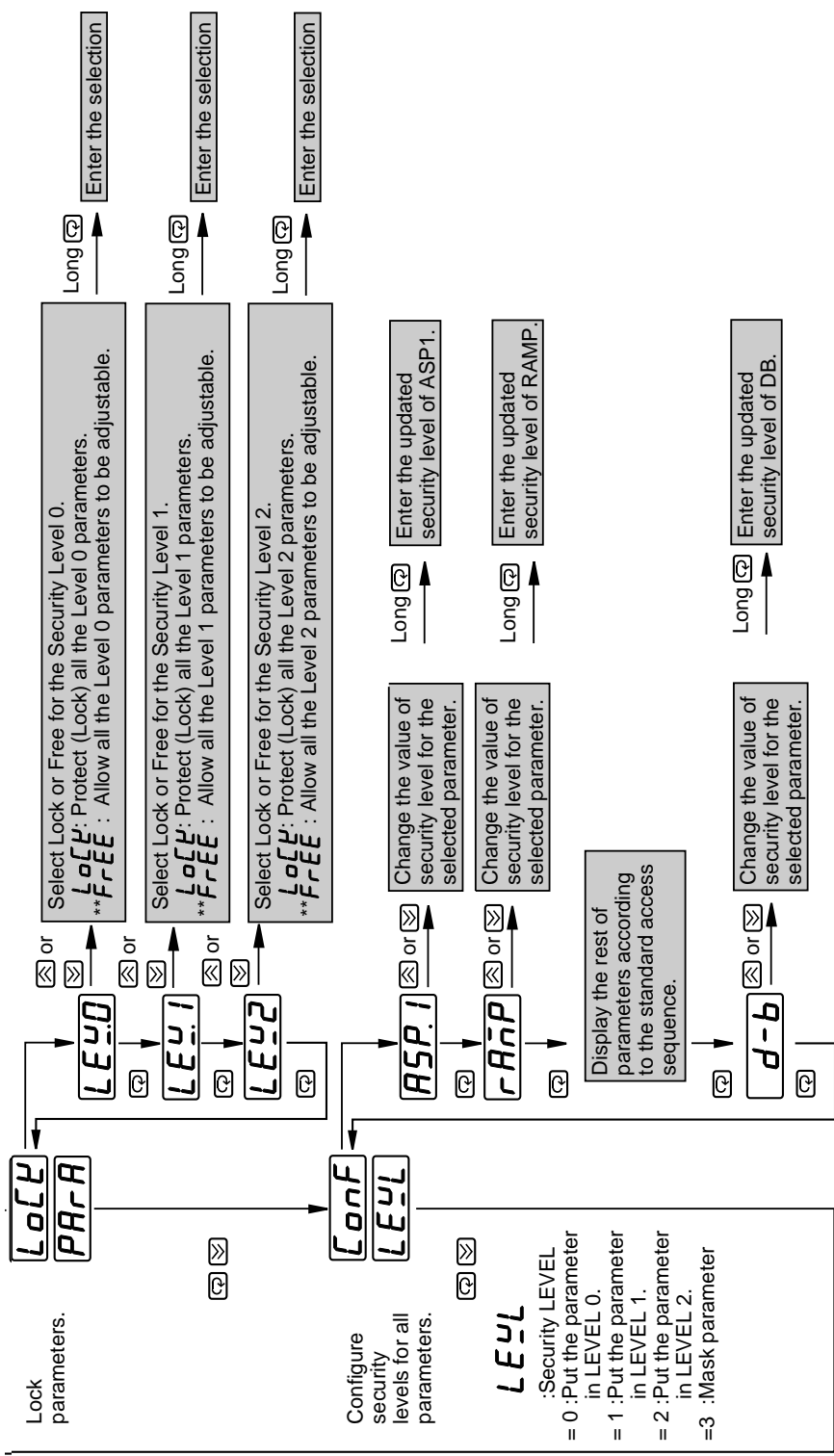



* Do not proceed through this section unless there is a definite need to re-calibrate the controller.
All previous calibration data will be lost.

MANUAL CONTROL

The outputs of this controller can be used in a manual mode. This enables the operator to apply a specific percentage of power to the system.

To use this unit in manual mode:

Enter the Tool Program Menu by pressing the  and the  key simultaneously.

The display will toggle between `hAnd` and `Cont` .



Press the  key momentarily.

The display will toggle between the process variable and the current output percentage `h---` .

To change output #1 skip this step, to change output #2 press the  key momentarily to display the output percentage for the cooling output `C---` .

Press and hold the  key for 3.2 seconds.

The display will begin flashing as it toggles between the process variable and `h---` .

Use the  and  keys to highlight and change the display `h---` to the desired output percentage.

Example:

`H 40` is viewed with cycle time `CYC` =10 sec.

The output 1 will act as shown:

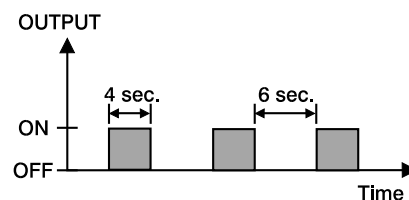

PROGRAMMABLE CONTROL ACTION

Output #1 can be used in a reverse action configuration (heating applications) or in a direct action configuration (cooling applications) by adjusting parameter `ConA`.

To adjust the control action of output #1;

Press the  key momentarily to enter the Primary Program Menu.

Press the  key momentarily to scroll through the Primary Program Menu until you come to `ConA`.

Pause momentarily. After 3.2 sec the display will begin to toggle between `ConA` and its current setting.

Press and hold either the  or  key to select the desired control action (`dir` = direct / `rev` = reverse).

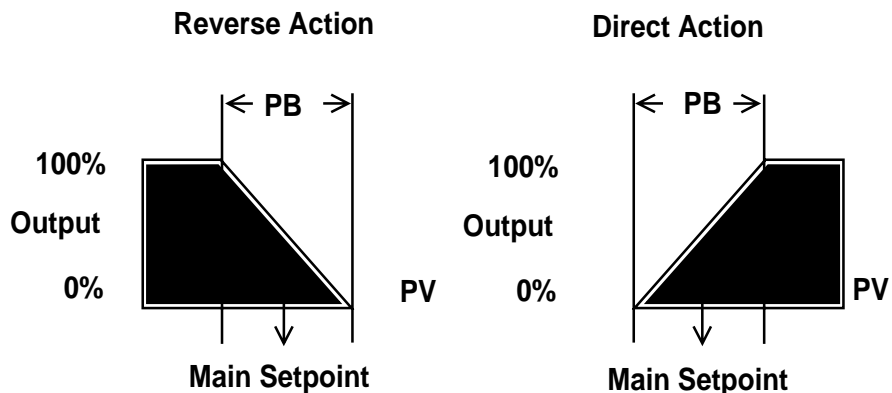

Note: PB = Proportional Band

COOLING CONTROL

This controller has the option of being configured as a single or a dual output controller.

The alarm output can be used as a control output by setting parameter **ALSF** in the Primary Program Menu to **COOL**. Once this is done the following parameters are used as output #2 control parameters;

CPB: Cooling Proportional Band

DB: Dead Band

CCYC: Cooling Cycle Time

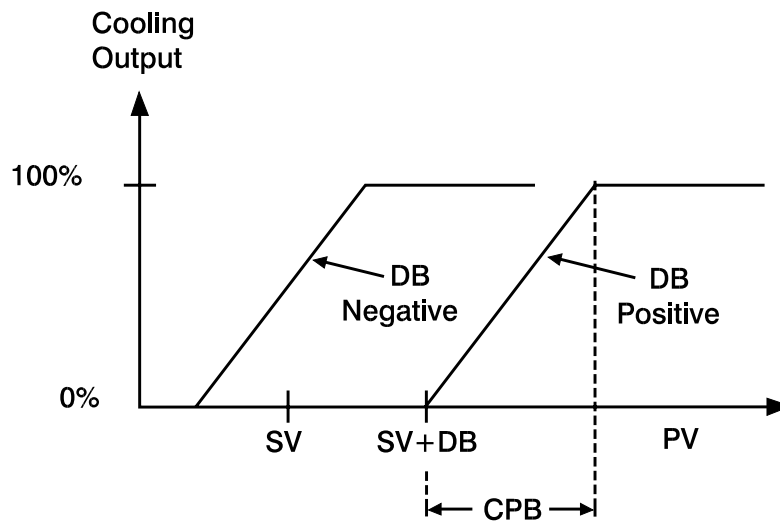

CONFIGURABLE MENUS

This controller gives you the flexibility to configure the menus in a way that is most convenient for your application. There are four menu levels that parameters in the primary program menu can be assigned to.

- LE40** . This is the first group of parameters within the Primary Program Menu. Locate parameters here that need to be changed frequently or that need to be accessed easily.

- LE41** . This is the second group of parameters within the Primary Program Menu. Locate parameters here that need to be accessed but not frequently.



- LE42** . This is the third group of parameters within the Primary Program Menu. Locate parameters here that are specific to your application but are not going to be changed.

- LE43** . This is a level used to mask parameters that are not used for your application or parameters that are not to be accessed by the operator.

continued on page 36

TO ASSIGN PARAMETERS TO A SPECIFIC LEVEL



Press the  key and the  key simultaneously to enter the Tool Program Menu.

Press the  key and the  key simultaneously to scroll through the Tool Program Menu until you come to **CONF** .

Pause momentarily. After 3.2 sec the display will begin to toggle between **CONF** and **LEVL** .

Press the  key to access the parameters under this, contained within the primary program menu and their current menu level.

Pause momentarily on a parameter to be changed. After 3.2 sec the display will begin to toggle between the parameter and the level it is currently assigned to.

Press and hold either the  or  key to increment or decrement to the menu level desired.

Press and hold the  key for 3.2 sec to register the selection.

LOCKING MENUS

The various menu levels within the Primary Program menu can be left free so that information can be viewed as well as changed, or any of the levels can be locked so that the information can only be viewed but not changed.

TO LOCK A MENU LEVEL WITHIN THE PRIMARY PROGRAM MENU



Press the  key and the  key simultaneously to enter the Tool Program Menu.

Press the  key and the  key simultaneously to scroll through the Tool Program Menu until you come to **LoCk** .

Pause momentarily. After 3.2 sec the display will begin to toggle between **LoCk** and **PARA** .









Press the  key to access the parameters **LE40** - **LE42** .

Pause momentarily on a menu level to be changed. After 3.2 sec the display will begin to toggle between the parameter and the lock setting it is currently set to.

Press and hold either the  or  key to increment or decrement to the lock level desired (**LoCk** = locked, **FrEE** = accessible).

Press and hold the  key for 3.2 sec to register the selection.

ERROR MESSAGES

Symptom	Probable Cause(s)	Solution
Process display shows: 	- Sensor break	- Replace RTD or sensor - Use manual mode operation
Process display shows: 	- Input signal beyond the low range, sensor fails	- Replace sensor - Check sensor or thermocouple type, correct input selection
Process display shows: 	- Input signal beyond the high range, sensor fails	- Replace sensor - Check sensor or thermocouple type, correct input selection
Process display shows: 	- A to D module damage	- Replace module - Check for outside source of damage such as transient voltage spikes
Process display shows: 	- Incorrect operation of auto tune procedure - Manual mode is not allowed for an ON-OFF control system	- Repeat procedure. Increase Prop. band to a number larger than 0.
Process display shows: 	- Check-sum error, values in memory may have changed accidentally.	- Check and reconfigure control parameters
Process display shows: 	- Fail to enter data into EEPROM	- Replace EEPROM
Process display shows: 	- Overflow error, data out of range during execution of program	- Check if there is noise coming in. - Replace EEPROM.
Process Display shows: 	- Attempt to change a locked parameter	- UNLOCK procedure stated in the flow chart of tool programs.

NOTES

WARRANTY/DISCLAIMER

OMEGA ENGINEERING, INC. warrants this unit to be free of defects in materials and workmanship for a period of 37 months from date of purchase. OMEGA Warranty adds an additional one (1) month grace period to the normal three (3) year product warranty to cover handling and shipping time. This ensures that OMEGA's customers receive maximum coverage on each product.

If the unit malfunctions, it must be returned to the factory for evaluation. OMEGA's Customer Service Department will issue an Authorized Return (AR) number immediately upon phone or written request. Upon examination by OMEGA, if the unit is found to be defective, it will be repaired or replaced at no charge. OMEGA's WARRANTY does not apply to defects resulting from any action of the purchaser, including but not limited to mishandling, improper interfacing, operation outside of design limits, improper repair, or unauthorized modification. This WARRANTY is VOID if the unit shows evidence of having been tampered with or shows evidence of having been damaged as a result of excessive corrosion; or current, heat, moisture or vibration; improper specification; misapplication; misuse or other operating conditions outside of OMEGA's control. Components which wear are not warranted, including but not limited to contact points, fuses, and triacs.

OMEGA is pleased to offer suggestions on the use of its various products. However, OMEGA neither assumes responsibility for any omissions or errors nor assumes liability for any damages that result from the use of its products in accordance with information provided by OMEGA, either verbal or written. OMEGA warrants only that the parts manufactured by it will be as specified and free of defects. OMEGA MAKES NO OTHER WARRANTIES OR REPRESENTATIONS OF ANY KIND WHATSOEVER, EXPRESS OR IMPLIED, EXCEPT THAT OF TITLE, AND ALL IMPLIED WARRANTIES INCLUDING ANY WARRANTY OF MERCHANTABILITY AND FITNESS FOR A PARTICULAR PURPOSE ARE HEREBY DISCLAIMED. LIMITATION OF LIABILITY: The remedies of purchaser set forth herein are exclusive, and the total liability of OMEGA with respect to this order, whether based on contract, warranty, negligence, indemnification, strict liability or otherwise, shall not exceed the purchase price of the component upon which liability is based. In no event shall OMEGA be liable for consequential, incidental or special damages.

CONDITIONS: Equipment sold by OMEGA is not intended to be used, nor shall it be used: (1) as a "Basic Component" under 10 CFR 21 (NRC), used in or with any nuclear installation or activity; or (2) in medical applications or used on humans. Should any Product(s) be used in or with any nuclear installation or activity, medical application, used on humans, or misused in any way, OMEGA assumes no responsibility as set forth in our basic WARRANTY/DISCLAIMER language, and, additionally, purchaser will indemnify OMEGA and hold OMEGA harmless from any liability or damage whatsoever arising out of the use of the Product(s) in such a manner.

RETURN REQUESTS/INQUIRIES

Direct all warranty and repair requests/inquiries to the OMEGA Customer Service Department. BEFORE RETURNING ANY PRODUCT(S) TO OMEGA, PURCHASER MUST OBTAIN AN AUTHORIZED RETURN (AR) NUMBER FROM OMEGA'S CUSTOMER SERVICE DEPARTMENT (IN ORDER TO AVOID PROCESSING DELAYS). The assigned AR number should then be marked on the outside of the return package and on any correspondence.

The purchaser is responsible for shipping charges, freight, insurance and proper packaging to prevent breakage in transit.

FOR WARRANTY RETURNS, please have the following information available BEFORE contacting OMEGA:

1. Purchase Order number under which the product was PURCHASED,
2. Model and serial number of the product under warranty, and
3. Repair instructions and/or specific problems relative to the product.

FOR NON-WARRANTY REPAIRS, consult OMEGA for current repair charges. Have the following information available BEFORE contacting OMEGA:

1. Purchase Order number to cover the COST of the repair,
2. Model and serial number of the product, and
3. Repair instructions and/or specific problems relative to the product.

OMEGA's policy is to make running changes, not model changes, whenever an improvement is possible. This affords our customers the latest in technology and engineering.

OMEGA is a registered trademark of OMEGA ENGINEERING, INC.

© Copyright 1998 OMEGA ENGINEERING, INC. All rights reserved. This document may not be copied, photocopied, reproduced, translated, or reduced to any electronic medium or machine-readable form, in whole or in part, without the prior written consent of OMEGA ENGINEERING, INC.

Where Do I Find Everything I Need for Process Measurement and Control? OMEGA...Of Course!

TEMPERATURE

- ☑ Thermocouple, RTD & Thermistor Probes, Connectors, Panels & Assemblies
- ☑ Wire: Thermocouple, RTD & Thermistor
- ☑ Calibrators & Ice Point References
- ☑ Recorders, Controllers & Process Monitors
- ☑ Infrared Pyrometers

PRESSURE, STRAIN

AND FORCE

- ☑ Transducers & Strain Gauges
- ☑ Load Cells & Pressure Gauges
- ☑ Displacement Transducers
- ☑ Instrumentation & Accessories

FLOW/LEVEL

- ☑ Rotameters, Gas Mass Flowmeters & Flow Computers
- ☑ Air Velocity Indicators
- ☑ Turbine/Paddlewheel Systems
- ☑ Totalizers & Batch Controllers

pH/CONDUCTIVITY

- ☑ pH Electrodes, Testers & Accessories
- ☑ Benchtop/Laboratory Meters
- ☑ Controllers, Calibrators, Simulators & Pumps
- ☑ Industrial pH & Conductivity Equipment

DATA ACQUISITION

- ☑ Data Acquisition & Engineering Software
- ☑ Communications-Based Acquisition Systems
- ☑ Plug-in Cards for Apple, IBM & Compatibles
- ☑ Datalogging Systems
- ☑ Recorders, Printers & Plotters

HEATERS

- ☑ Heating Cable
- ☑ Cartridge & Strip Heaters
- ☑ Immersion & Band Heaters
- ☑ Flexible Heaters
- ☑ Laboratory Heaters

ENVIRONMENTAL MONITORING AND CON- TROL

- ☑ Metering & Control Instrumentation
- ☑ Refractometers
- ☑ Pumps & Tubing
- ☑ Air, Soil & Water Monitors
- ☑ Industrial Water & Wastewater Treatment
- ☑ pH, Conductivity & Dissolved Oxygen Instruments