

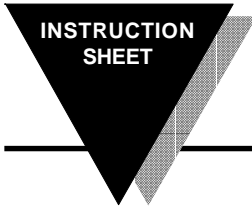

BG18- 5

Bar Graph Indicator



M2128/1294

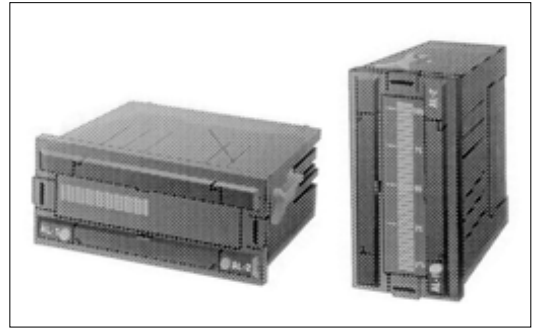

LED SEGMENTS BARGRAPH VOLTMETER WITH BIPOLAR CENTER ZERO

BARGRAPH with 30 bright LED segments, with the central one, always switched ON.
 The BG18-5 is particularly well suited to provide dynamic analog visualization of direct voltages, ± 10 Vdc. FULL SCALE.
 Model BG18-5 is a BAR GRAPH indicator with bipolar center zero. LED segments are switched ON, in a progressive way, in both directions from zero

FRONT VIEW

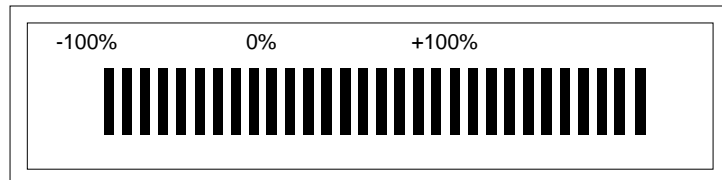

REAR VIEW

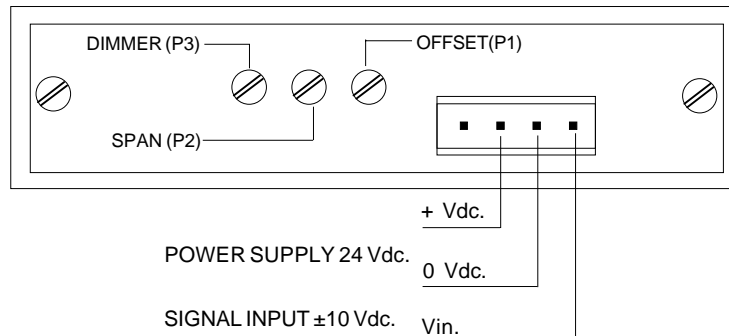

SPECIFICATIONS

STANDARD POWER	16-30 Vdc. (24 Vdc.).
SIGNAL INPUT	± 10 Vdc.
INPUT RESISTANCE	100 K Ω .
ACCURACY	± 1 LED segment.
BRIGHTNESS CONTROL P3	Adjustable (Dimmer).
SPAN RANGE P2	From ± 8 to ± 16 Vdc. ($V_{in} \pm 10$ Vdc.).
OFFSET RANGE P1	From +5 to -15 LEDS. ($V_{in} = 0$ Vdc.).
OPERATING TEMPERATURE	0 °C to +50 °C (32 to 122 °F).
STORAGE TEMPERATURE	-40 °C to +85 °C (-40 to 176 °F).
WARMUP TO RATED ACCURACY	2 minutes.
WEIGHT	100 gr. (0.22 lb) (approx.).
ELECTRICAL CONNECTIONS	Push IN cable connectors.
POWER CONSUMPTION	Min. = 30 mA (Dimmer min.). Max. = 80 mA (Dimmer max.).
DIMENSIONS	3.78" x 0.94" (96 x 24 mm.) DIN 43700.
CASE MATERIAL	ABS, black color.

MECHANICAL DIMENSIONS, mm (in)

PANEL CUTOUT

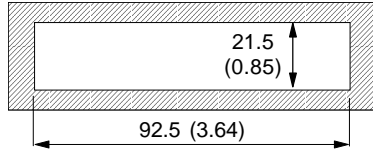

CASE DIMENSIONS

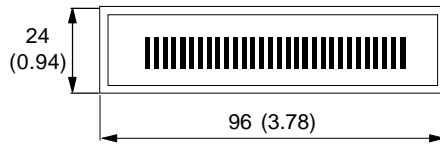

PANEL MAX. THICKNESS

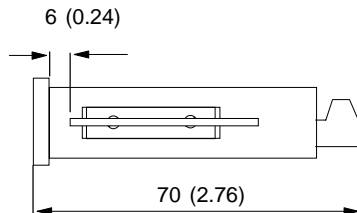

WARRANTY/DISCLAIMER

OMEGA warrants this unit to be free of defects in materials and workmanship and to give satisfactory service for a period of **13 months** from date of purchase. OMEGA Warranty adds an additional one (1) month grace period to the normal **one (1) year product warranty** to cover handling and shipping time. This ensures that OMEGA's customers receive maximum coverage on each product. If the unit should malfunction, it must be returned to the factory for evaluation. OMEGA's Customer Service Department will issue an Authorized Return (AR) number immediately upon phone or written request. Upon examination by OMEGA, if the unit is found to be defective it will be repaired or replaced at no charge. However, this WARRANTY is VOID if the unit shows evidence of having been tampered with or shows evidence of being damaged as a result of excessive corrosion; or current; heat; moisture or vibration; improper specification; misapplication; misuse or other operating conditions outside of OMEGA's control. Components which wear or which are damaged by misuse are not warranted. These include contact points, fuses and triacs.

OMEGA is pleased to offer suggestions on the use of its various products. However OMEGA neither assumes responsibility for any omissions or errors nor assumes liability for any damages that result from the use of its products in accordance with information provided by OMEGA, either verbal or written. OMEGA only warrants that the parts manufactured by it will be as specified and free of defects. OMEGA MAKES NO OTHER WARRANTIES OR REPRESENTATIONS OF ANY KIND WHATSOEVER, EXPRESSED OR IMPLIED, EXCEPT THAT OF TITLE AND ALL IMPLIED WARRANTIES INCLUDING ANY WARRANTY OF MERCHANTABILITY AND FITNESS FOR A PARTICULAR PURPOSE ARE HEREBY DISCLAIMED.

LIMITATION OF LIABILITY: The remedies of purchaser set forth herein are exclusive and the total liability of OMEGA with respect to this order, whether based on contract, warranty, negligence, indemnification, strict liability or otherwise, shall not exceed the purchase price of the component upon which liability is based. In no even shall OMEGA be liable for consequential, incidental or special damages.

CONDITIONS: Equipment sold by OMEGA is not intended to be used, nor shall it be used: (1) as a "Basic Component" under 10 CFR 21 (NRC), used in or with any nuclear installation or activity; or (2) in medical applications or used on humans. Should any Product(s) be used in or with any nuclear installation or activity, medical application, used in humans, or misused in any way. OMEGA assumes no responsibility as set forth in our basic WARRANTY/DISCLAIMER language, and, additionally, purchaser will indemnify OMEGA and hold OMEGA harmless from any liability or damage whatsoever arising out of the use of the Product(s) in such a manner.



Servicing USA and Canada: Call OMEGA Toll Free
USA **Canada**

One Omega Drive, Box 4047 976 Bergar
 Stamford, CT 06907-0047 Laval (Quebec) H7L 5A1
 Telephone: (203) 359-1660 Telephone: (514) 856-6928
 FAX: (203) 359-7700 FAX: (514) 856-6886

Sales Service: 1-800-826-6342 / 1-800-TC-OMEGASM
 Customer Service: 1-800-622-2378 / 1-800-622-BESTSM
 Engineering Service: 1-800-872-9436 / 1-800-USA-WHENSM
 TELEX: 996404 EASYLINK: 62968934 CABLE: OMEGA

Servicing Europe: One OMEGA Drive, River Bend
Thecnology Centre

Northbank, Irlam, Manchester
 M44 5EX, England

Telephone: 44 (161) 777-6611 FAX: 44 (161) 777-6622

RETURN REQUESTS/INQUIRIES

Direct all warranty and repair requests/inquiries to the OMEGA ENGINEERING Customer Service Department. BEFORE RETURNING ANY PRODUCT(S) TO OMEGA, PURCHASER MUST OBTAIN AN AUTHORIZED RETURN (AR) NUMBER FROM OMEGA'S CUSTOMER SERVICE DEPARTMENT (IN ORDER TO AVOID PROCESSING DELAYS). The assigned AR number should then be marked on the outside of the return package and on any correspondence.

FOR **WARRANTY** RETURNS, please have the following information available BEFORE contacting OMEGA:

1. P.O. number under which the product was PURCHASED.
2. Model and serial number of the product under warranty, and
3. Repair instructions and/or specific problems relative to the product.

FOR **NON-WARRANTY** REPAIRS, consult OMEGA for current repair charges. Have the following information available BEFORE contacting OMEGA:

1. P.O. number to cover the COST of the repair,
2. Model and serial number of product, and
3. Repair instructions and/or specific problems relative to the product.

OMEGA's policy is to make running changes, not model changes, whenever an improvement is possible. This affords our customers the latest in technology and engineering. OMEGA is a registered trademark of OMEGA ENGINEERING, INC. ©Copyright 1998 OMEGA ENGINEERING, INC. All rights reserved. This documentation may not be copied, photocopied, reproduced, translated, or reduced to any electronic medium or machine-readable form, in whole or in part, without prior written consent of OMEGA ENGINEERING, INC.