

CE

MADE
IN
USA



User's Guide



<http://www.omega.com>
e-mail: info@omega.com

**DP116-RTD
MINIATURE PANEL
THERMOMETER**

omega.com[®]

— Ω OMEGA —

OMEGAnet[®] On-Line Service
http://www.omega.com

Internet e-mail
info@omega.com

Servicing North America:

USA:

ISO 9001 Certified

One Omega Drive, P.O. Box 4047
Stamford, CT 06907-0047
Tel: (203) 359-1660
e-mail: info@omega.com

FAX: (203) 359-7700

Canada:

976 Bergar
Laval (Quebec) H7L 5A1
Tel: (514) 856-6928
e-mail: info@omega.ca

FAX: (514) 856-6886

For immediate technical or application assistance:

USA and Canada: Sales Service: 1-800-826-6342 / 1-800-TC-OMEGA[®]
Customer Service: 1-800-622-2378 / 1-800-622-BEST[®]
Engineering Service: 1-800-872-9436 / 1-800-USA-WHEN[®]
TELEX: 996404 EASYLINK: 62968934 CABLE: OMEGA

Mexico:

Tel: (001) 800-TC-OMEGA[®]
En Español: (001) 203-359-7803

FAX: (001) 203-359-7807

e-mail: info@omega.com.mx

Servicing Europe:

Benelux:

Postbus 8034, 1180 LA Amstelveen, The Netherlands
Tel: +31 (0)20 6418405
Toll Free in Benelux: 0800 0993344
e-mail: nl@omega.com

FAX: +31 (0)20 6434643

Czech Republic:

Rudé armády 1868, 733 01 Karviná 8
Tel: +420 (0)69 6311899
e-mail: czech@omega.com

FAX: +420 (0)69 6311114

France:

9, rue Denis Papin, 78190 Trappes
Tel: +33 (0)130 621 400
Toll Free in France: 0800406342
e-mail: france@omega.com

FAX: +33 (0)130 699 120

Germany/Austria: Daimlerstrasse 26, D-75392 Deckenpfronn, Germany

Tel: +49 (0)7056 9398-0
Toll Free in Germany: 0800 TC-OMEGA[®]
e-mail: germany@omega.com

FAX: +49 (0)7056 9398-29

United Kingdom:

ISO 9002 Certified

One Omega Drive,
River Bend Technology Centre
Northbank, Irlam
Manchester M44 5EX United Kingdom
Tel: +44 (0)161 777 6611
Toll Free in United Kingdom: 0800 488 488
e-mail: sales@omega.co.uk

FAX: +44 (0)161 777 6622

It is the policy of OMEGA to comply with all worldwide safety and EMC/EMI regulations that apply. OMEGA is constantly pursuing certification of its products to the European New Approach Directives. OMEGA will add the CE mark to every appropriate device upon certification.

The information contained in this document is believed to be correct but OMEGA Engineering, Inc. accepts no liability for any errors it contains, and reserves the right to alter specifications without notice.

WARNING: These products are not designed for use in, and should not be used for, patient connected applications.



This device is marked with the international hazard symbol. It is important to read the Setup Guide before installing or commissioning this device as it contains important information relating to safety and EMC.

TABLE OF CONTENTS

SECTION		PAGE
	Prefaceii
	Models Availableiii
Section 1	Introduction1
1.1	Unpacking1
1.2	Safety Considerations2
Section 2	About the Meter3
2.1	Front of the Meter3
2.2	Back of the Meter4
2.3	Connector Description4
Section 3	Getting Started5
3.1	Main Board Power Jumpers5
3.2	Changing the Meter Parameters7
3.3	Installation and Panel Mounting10
3.4	Sensor Input Connections12
3.5	Analog Output Connections14
3.6	Display Hold Connections15
3.7	Main Power Connections16
3.8	Disassembly/Assembly18
Section 4	Operation and Calibration20
4.1	Equipment Required20
4.2	Calibration Procedure21
Section 5	Specifications23
Section 6	Glossary26

PREFACE

Manual Objectives: This manual shows you how to set up and use the RTD Panel Thermometer.

This meter is an economical Miniature Temperature Panel Thermometer featuring a large display with a linearized analog output that is supplied as a standard feature.

Each of the models* can be converted by the user to display in degrees Fahrenheit or Celsius between one degree and a tenth degree resolution.

RTD is an abbreviation for resistive temperature detector. The meter is designed to measure 100 ohm platinum resistance with 0.00385 temperature coefficient, also known as the European curve. The RTD will change resistance with a change in temperature. When using a 2-wire measurement configuration, lead wire impedance can contribute significant error to the temperature measurement. When using long lead wires a 3- or 4-wire measurement configuration is recommended.

The meter is available in platinum RTD with 2-, 3-, or 4-wire connections. All of the models listed in **Table 1-1** come standard with red LEDs, and can be ordered with a green LED display as an option. The part numbers would then end with “-GR”.

Example: DP116-MF1-GR

Also, these meters can be ordered with different power configurations. Refer to **Table 1-3** for available choices.

*Refer to **Table 1-1** for the complete listing of models available.

MODELS AVAILABLE

TABLE 1-1

RTD MODELS AVAILABLE

The following 3-1/2 digit mini RTD panel meters are available and discussed in this Operator's Manual.

MODEL	TYPE	°C or °F	RESOLUTION
DP116-MF1	RTD	F	1.0°F
DP116-MF2	RTD	F	0.1°F
DP116-MC1	RTD	C	1.0°C
DP116-MC2	RTD	C	0.1°C

Note 

The accuracies and ranges are listed in Section 5.

TABLE 1-2

Power Options Available

MODEL	POWER
DP116-Mxx	115 Vac \pm 15%, 50/60 Hz
DP116-Mxx type-230	230 Vac \pm 15%, 50/60 Hz
DP116-Mxx type-9/26	9-26 Vdc @ 110mA max.
DP116-Mxx type-100	100 Vac \pm 15%, 50/60 Hz
DP116-Mxx type-24	24 Vac \pm 15%, 50/60 Hz

TABLE 1-3**Other Models Available**

The following 3-1/2 digit mini thermocouple panel thermometers are discussed in a separate manual.

MODEL	TYPE	°C or °F	RESOLUTION
DP116-JF1	J	F	1.0°F
DP116-JF2	J	F	0.1°F
DP116-JC1	J	C	1.0°C
DP116-JC2	J	C	0.1°C
DP116-KF1	K	F	1.0°F
DP116-KF2	K	F	0.1°F
DP116-KC1	K	C	1.0°C
DP116-KC2	K	C	0.1°C
DP116-TF1	T	F	1.0°F
DP116-TF2	T	F	0.1°F
DP116-TC1	T	C	1.0°C
DP116-TC2	T	C	0.1°C
DP116-EF1	E	F	1.0°F
DP116-EF2	E	F	0.1°F
DP116-EC1	E	C	1.0°C
DP116-EC2	E	C	0.1°C

NOTES, WARNINGS and CAUTIONS

Information that is especially important to note is identified by these labels:



NOTE: provides you with information that is important to successfully setup and use the Programmable Digital Meter.



CAUTION or WARNING: tells you about the risk of electric shock.



CAUTION, WARNING or IMPORTANT: tells you of circumstances or practices that can effect the meter's functionality and must refer to accompanying documents.

SECTION 1 INTRODUCTION

1.1 UNPACKING

Remove the Packing List and verify that all equipment has been received. If there are any questions about the shipment, use the phone number for the Customer Service Department nearest you.

Upon receipt of shipment, inspect the container and equipment for any signs of damage. Take particular note of any evidence of rough handling in transit. Immediately report any damage to the shipping agent.

Note

The carrier will not honor any claims unless all shipping material is saved for their examination. After examining and removing contents, save packing material and carton in the event reshipment is necessary.

Verify that you received the following items in the shipping box:

QTY DESCRIPTION

- 1 Panel Thermometer with 3 small connectors plugged into the rear of the meter.
- 1 Operator's Manual

1.2 SAFETY CONSIDERATIONS



This device is marked with the international caution symbol. It is important to read this manual before installing or commissioning this device as it contains important information relating to Safety and EMC (Electromagnetic Compatibility).

Unpacking & Inspection

Note

Unpack the instrument and inspect for obvious shipping damage. Do not attempt to operate the unit if damage is found.

This instrument is a panel mount device protected in accordance with Class I of EN 61010 (115/230 AC power connections). Installation of this instrument should be done by Qualified personnel. In order to ensure safe operation, the following instructions should be followed.

This instrument has no power-on switch. An external switch or circuit-breaker shall be included in the building installation as a disconnecting device. It shall be marked to indicate this function, and it shall be in close proximity to the equipment within easy reach of the operator. The switch or circuit-breaker shall not interrupt the Protective Conductor (Earth wire), and it shall meet the relevant requirements of IEC 947-1 and IEC 947-3 (International Electrotechnical Commission). The switch shall not be incorporated in the mains supply cord.

Furthermore, to provide protection against excessive energy being drawn from the mains supply in case of a fault in the equipment, an overcurrent protection device shall be installed.



- The **Protective Conductor** must be connected for safety reasons. Check that the power cable has the proper Earth wire, and it is properly connected. It is not safe to operate this unit without the Protective Conductor Terminal connected.

Note

- Do not exceed voltage rating on the label located on the top of the instrument housing.
- Always disconnect power before changing signal and power connections.
- Do not use this instrument on a work bench without its case for safety reasons.
- Do not operate this instrument in flammable or explosive atmospheres.
- Do not expose this instrument to rain or moisture.
- Unit mounting should allow for adequate ventilation to ensure instrument does not exceed operating temperature rating.
- Use electrical wires with adequate size to handle mechanical strain and power requirements. Install without exposing bare wire outside the connector to minimize electrical shock hazards.

EMC Considerations

- Whenever EMC is an issue, always use shielded cables.
- Never run signal and power wires in the same conduit.
- Use signal wire connections with twisted-pair cables.
- Install Ferrite Bead(s) on signal wires close to the instrument if EMC problems persist.

SECTION 2 ABOUT THE METER

2.1 Front of the Meter

Figure 2-1 shows the panel thermometer.



Figure 2-1. Panel Thermometer

Features:

Display: 3 1/2 Digit, 7-Segment Red or Green LED

Full-size: 14.2 mm (0.56") LED Display

Analog Output Standard

3/64 DIN Standard Panel Cutout

Removable Screw-Clamp Cable Connector

Display Hold Capability

2.2 Back of the Meter

Figure 2-2 illustrates the rear of the meter.

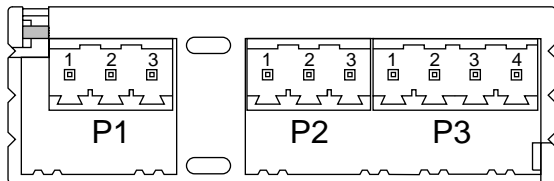

Figure 2-2. Rear View Showing P1, P2, P3 Locations

2.3 Connector Description

Connector Description	Connector	PIN #
(AC) Earth Ground	P1	1
(AC) Neutral	P1	2
(AC) Line	P1	3
(DC) -DC Return	P1	1
(DC) +DC	P1	2
(DC) No Connection (Not used)	P1	3
Display Hold (Active Low)	P2	1
Analog Return	P2	2
Analog Output	P2	3
RTD Input† -EXC	P3	1
RTD Input† Signal Lo	P3	2
RTD Input† Signal Hi	P3	3
RTD Input† +EXC	P3	4

† For RTD input wires, refer to **Figure 3-3** thru **3-6**.

SECTION 3 GETTING STARTED

3.1 Main Board Power Jumpers



Caution: The meter has no power-on switch, so it will be in operation as soon you apply power.

The meter can be configured to operate on 115VAC or 230VAC by the proper combination of the soldered wire jumpers that are located on the printed circuit board. The meter is set at the factory to be powered by the voltage specified at the time of ordering. The same transformer is used for either configuration, so all you need to do is to select the jumpers as described in this section.



Important: These changes must be performed by a qualified technician.

Note

To change the Factory preset jumpers, do the following steps:

Disconnect the power from the unit before proceeding.

1. Remove the main board from the case. Refer to Disassembly/Assembly **Section 3.8**.
2. Locate the solder jumpers W1, W2, and W3 (located near the edge of the main board alongside the transformer).
3. If your power requirement is 115 V ac, solder jumpers W1 and W3 should be wired, but jumper W2 should not. If your power requirement is 230 Vac, solder jumper W2 should be wired, but jumpers W1 and W3 should not.

Voltage Jumper Pin Settings

AC VOLTAGE	INSTALL	REMOVE
115VAC	W1, W3	W2
230VAC	W2	W1, W3

Figure 3-1 shows the location of solder jumpers W1 through W3.

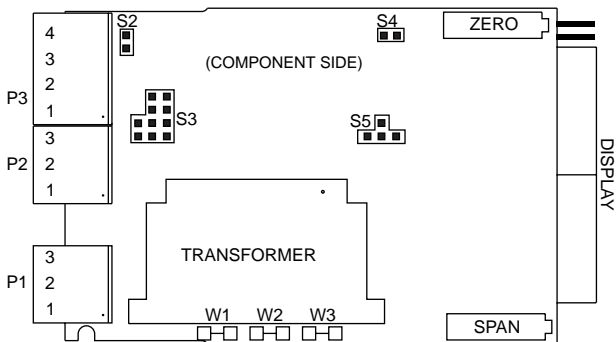

Figure 3-1. Power Jumper Locations

3.2 Changing the Meter Parameters

The proper combinations of jumper plugs S1, S2, S3, S4, and S5 inside the meter allow you to change various parameters of the meter. These parameters include resolution, range, units, RTD sensor configuration and sensor break configuration. You can change the parameters by moving the plugs on one or several of the jumper locations. Keep in mind that the meter is factory set for 3-wire RTD, and for the upscale position.

Figure 3-2 shows the location of the jumper plugs S1 through S5.

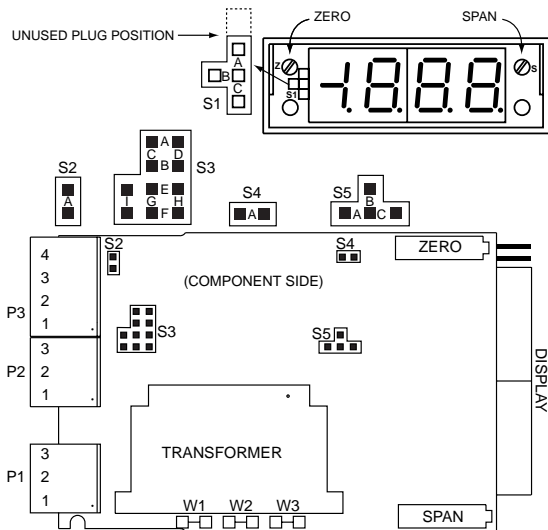

Figure 3-2. Jumper Plugs S1 through S5

The following tables summarize what parameters you can change.

TABLE 3-1 Range Parameters

Option	F/C	Resolution	Range	S1	S4	S5
*-MF1	°F	1°	-328 to + 1562°F	--	A	A
*-MF2	°F	0.1°	-199.9 to + 199.9°F	C	--	C
*-MC1	°C	1°	-200 to + 850°C	--	A	B
*-MC2	°C	0.1°	-199.9 to + 199.9°C	C	--	B

* Refer to **Table 1-1**, for complete models (preface section).

TABLE 3-2 2-, 3-, 4-Wire, Upscale, Downscale Configuration

Configuration	S2	S3	S3	
			Upscale (Default)	Downscale
2- or 4-wire RTD	--	--	A, B, E, F	C, D, G, H
3-Wire RTD	A	I	A, B, E, F	C, D, G, H

Note

3-Wire input connection is standard. For 2- or 4-Wire remove S2-A and S3-I

Figure 3-3 gives an example of how to set S4 and S5 to configure a MF1 meter option. There is a jumper plug across A on S4 and another jumper plug across A on S5. B and C on S5 are not used.

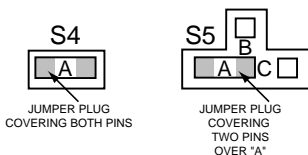

Figure 3-3. Example of How to Set Meter Option MF1 (jumpers S4 and S5)

SENSOR BREAK PROTECTION:

The proper combination of jumpers on S3 will determine the direction in which the display and analog output will go if the RTD sensor breaks (upscale or downscale). The meter is factory set to upscale break protection. If the sensor breaks, the display and analog signal will increment (upscale) and the 3 least significant digits will then go blank. If you require downscale break protection, refer to **Table 3-2** to change the S3 jumper configuration.

Section 3.3 Installation and Panel Mounting

Figure 3-4 shows the panel cutout dimensions, the dimensions for the panel thickness, and the mounting clamp for mounting the unit in a panel. **Connections will be done after mounting the unit.**

1. Remove the lens by inserting a paper clip or a small flat blade screwdriver into the rounded corner of the lens and lift out.
2. Remove the two mounting screws from both sides of the display. Pry both sides of the mounting clamp out and down to remove it from the meter case.
3. Insert the meter into the panel cutout and reinstall the mounting clamp to the bottom of the meter case from the rear of the panel.
4. Re-install the mounting screws to secure the meter in the panel. Do not over-tighten the screws.
5. Pop the lens back in, making sure the dull side of the lens faces towards you.

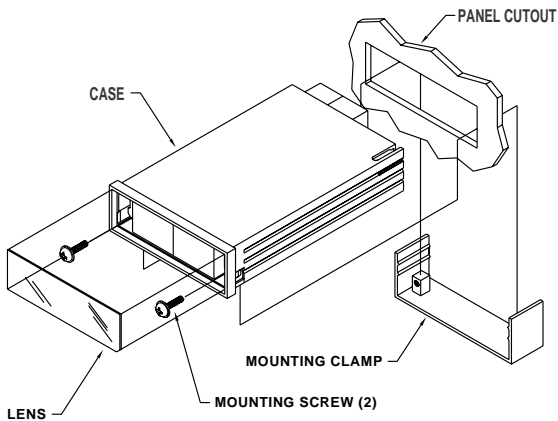
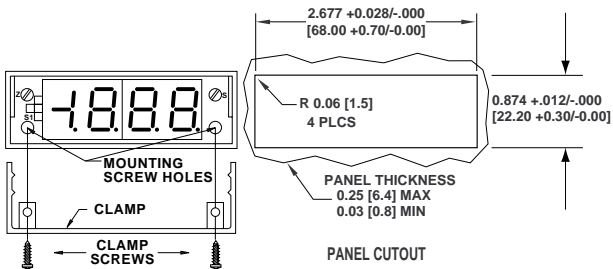

Figure 3-4. Installation Information

3.4 Sensor Input Connections

The RTD sensor (see **Figure 3-5**), can be wired in three different ways. They are 2-, 3-, and 4-wire configurations. The meter is factory set internally to a 3-wire setup. If you wish to change it, refer to **Table 3-2**.

2-Wire RTD:

Externally wire the P3 connector according to **Figure 3-6**. Keep in mind that you will need to jumper pins 1 and 2 on P3 together, and jumper pins 3 and 4 on P3 together. Use 24 AWG wire. The black lead goes to Pin 1 or 2 and the red lead goes to Pin 3 or 4.

3-Wire RTD:

Externally wire the P3 connector according to **Figure 3-7**. Pin 4 on the P3 connector is not used.

4-Wire RTD:

Externally wire the P3 connector according to **Figure 3-8**.

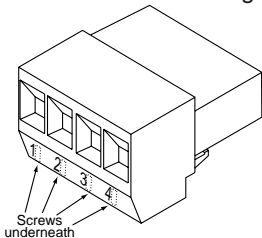

Figure 3-5. RTD P3 Connector

See **Figure 2-2** for the location of the P3 connector.

3.4 Sensor Input Connections (Continued)

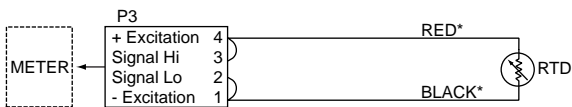

Figure 3-6. 2-Wire RTD Wiring

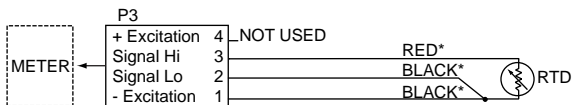

Figure 3-7. 3-Wire RTD Wiring

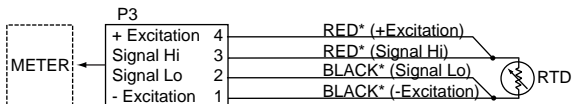

Figure 3-8. 4-Wire RTD Wiring

Note Refer to **Table 3-1** and **Table 3-2** for internal jumper settings.

* Wire colors are for OMEGA RTD wiring only.

3.5 Analog Output Connections

The analog output is a linearized millivolt signal that is equivalent to the displayed temperature. It comes as a standard feature with every unit. The resolution of the analog output is no greater than the resolution of the display.

Note

The analog output is a non-isolated signal.

To access the analog signal, attach copper wire to the 3-pin female connector that is supplied with the meter. Refer to **Figure 3-9** for wiring instructions. Plug the female connector into the P2 (male) connector at the rear of the meter.

Figure 2-2 shows the location of the P2 connector on the meter. Note that this connector shares a common return with the “Display Hold” function.

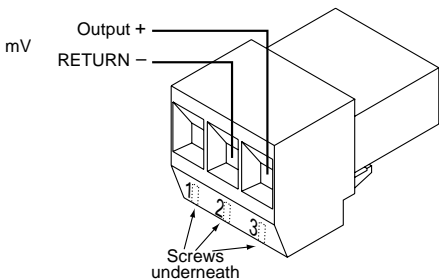

Figure 3-9. Analog Output Connections (P2)

3.6 Display Hold Connections

The “Display Hold” function can be used to freeze the display. Connect a single pole, single throw (SPST) switch between pins 1 and 2 on the P2 connector. The display will stop updating when this switch is on. When this switch is off, the display will update itself 2.5 times per second.

To access the “Display Hold” function, attach copper wire to the 3-pin female connector that is supplied with the meter. Refer to **Figure 3-10** for wiring instructions. This connector shares a common return with the Analog Output. Plug the female connector into the P2 connector at the rear of the meter.

Figure 2-2 shows the location of the P2 connector on the meter.

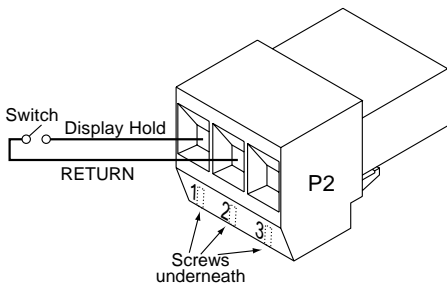

Figure 3-10. Display Hold Connections

3.7 Main Power Connections

Connect the ac main power connections as shown below.



WARNING: Do not connect ac power to your meter until you have completed all input and output connections. Failure to do so may result in injury! This device must only be installed electrically by specially trained electrician with corresponding qualifications. The main power input to the unit as well as the AC input signal to be measured must agree with the wiring instruction.

The meter is factory set to the power specified by the customer at the time of ordering. The voltage is printed on the Label under Input power.

Note

Refer to **Section 3-2** to convert from one configuration to another

To connect power to the unit, attach wires from the ~AC power cord to the orange 3-pin female connector that is supplied with the meter. Refer to **Figure 3-11** for wiring instructions. Plug the female connector into the orange P1 (male) connector at the rear of the meter.

Figure 2-2 shows the location of P1 on the meter.

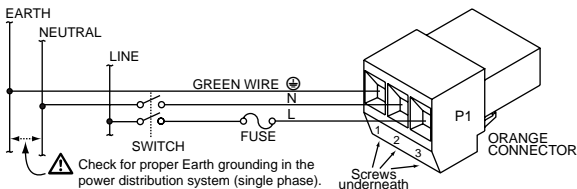

Figure 3-11. ~AC Connector Wiring (P1)

DC WIRING

The meter can be configured at the factory to operate on a 9–26 VDC non-isolated power. The DC voltage option is specified at the time of ordering. See **Table 1-3** for model number listing. An AC powered meter cannot be converted to a DC powered meter or vice versa.

To connect power to the unit, attach the DC power wires to the orange 3-pin female connector that is supplied with the meter. Refer to **Figure 3-12** for wiring instructions. Plug the female connector into the orange P1 (male) connector at the rear of the meter.

Figure 2-2 shows the location of P1 on the meter.

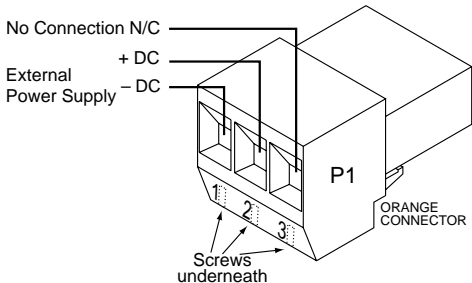

Figure 3-12. =DC Power Connector Wiring (P1)

3.8 Disassembly/Assembly

Note

You must go through the following steps in order to remove the printed circuit board from the case if you want to change from 115VAC to 230VAC (or vice versa) or to change from Fahrenheit to Celsius (or vice versa). These changes must be performed by a qualified technician in order to avoid damage to the unit.



WARNING: Do not connect ac power to your meter until you have completed all input and output connections. Failure to do so may result in injury!

1. Remove power and all wire connections from the unit.
2. Unplug the three connectors (P1, P2, and P3) from the back of the meter. Grasp them firmly on the top and bottom of the connector and pull. **Figure 3-13** shows the location of the three connectors.
3. Remove the lens, mounting screws, and mounting clamp from the unit as described in steps 1 and 2 in **Section 3**. Slide the unit out of the panel (if it is installed in a panel).
4. The printed circuit board is held in place by a tab and notch system located next to the P1 connector, pin 1 (refer to **Figure 3-13**). The tab is on the case and the notch is on the edge of the PC Board. Hold the meter with the display facing away from you. Gently pry the tab (on the back corner of the case) out with the edge of your finger, while pushing the back of the PC Board out through the front of the meter. The PC Board will slide out the front, free from the case.

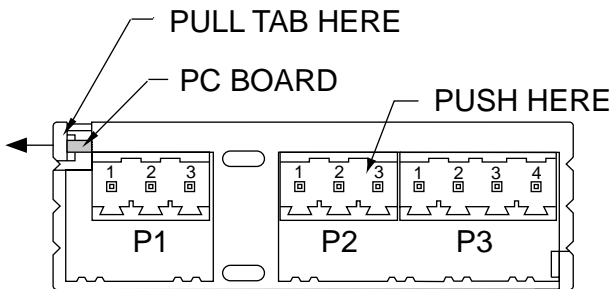

Figure 3-13. Removing the PC Board from the Case

When re-installing the printed circuit board:

1. Hold the case (with the two mounting holes facing upwards and to the right side of the case) in the left hand.
2. Hold the printed circuit board with the components showing (soldered side down) in the right hand.
3. Slip the component board into the case and slide in as far as it will go. You will also have to release the tab at the rear on the other side of the case (turn case over) to allow the board to fit all the way inside the case.
4. Go through steps 3 thru 5 in **Section 3.3** in order to re-install the mounting clamp, screws, and lens.

SECTION 4 OPERATION AND CALIBRATION



Important: These changes must be performed by a qualified technician.



WARNING: Do not connect ac power to your meter until you have completed all input and output connections. Failure to do so may result in injury!

1. Wire the meter according to the wiring section. This includes power, thermocouple and analog signal connections.
2. Apply power to the meter and the display will show the temperature of the probe.

The meter is shipped from the factory calibrated to the accuracy as specified. No re-calibration is necessary. In the event that there is a desire to check the calibration, the following procedure is given.

4.1 EQUIPMENT REQUIRED

- Meter
- a small screwdriver
- a precision resistance source in 0.01° resolution or "Decade Box".

4.2 CALIBRATION PROCEDURE

1. Remove the front lens. Connect power to the meter, observing proper wiring procedures.
2. Connect the precision resistance source to the P3 connector observing proper wiring configuration. For 3-wire connections, use pins 1, 2, 3, and 4. Refer to **Figures 4-1** through **4-3**.
3. Apply resistance input as indicated in **Table 4-1**.
4. Adjust either the **ZERO** or **SPAN** potentiometer as shown in **Figure 4-4**.
5. After adjusting the post, go back and verify both temperature readings. Repeat step 4 as required.

Note

Refer to **Table 3-1** and **Table 3-2** for internal jumper settings.

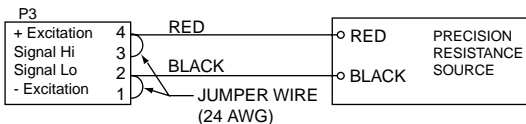

Figure 4-1. 2-Wire Configuration

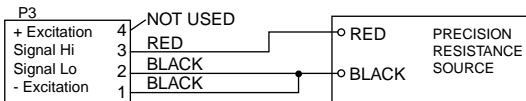

Figure 4-2. 3-Wire Configuration

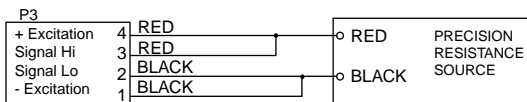

Figure 4-3. 4-Wire Configuration

TABLE 4-1

CALIBRATION VALUES WHEN YOU ARE USING RESISTANCE SOURCE

MODEL OPTION	RESISTANCE READING	METER DISPLAY	POT TO ADJUST
*-MF1	93.01 375.51	00°F 1472°F	ZERO SPAN
*-MF2	93.01 134.70	00.0°F 194.0°F	ZERO SPAN
*-MC1	100 375.51	00°C 800°C	ZERO SPAN
*-MC2	100.0°C 174.0°C	00°C 195.0°C	ZERO SPAN

* Refer to **Table 1-1**, for complete models (preface section).

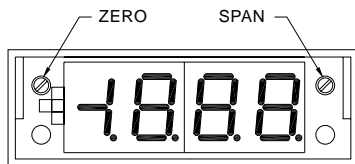

Figure 4-4. Calibration Potentiometers

SECTION 5 SPECIFICATIONS

INPUT TYPE:

RTD:	100-ohm platinum with alpha of 0.00385
Calibration:	IEC 751 (IP1S-68)
Configuration:	2-, 3-, or 4-wire RTD connection
Polarity:	Bipolar
Zero:	Adjustable $\pm 20^{\circ}\text{C}$ ($\pm 36^{\circ}\text{F}$)
Zero Tempco†:	$\pm 0/05$ degree/degree
Sensor-wire Resistance Tempco† Effect per Conductor:	
2-wire:	20 mdeg/ Ω /degree, up to 3.8 Ω
3-wire:	50 μ deg/ Ω /degree, up to 100 Ω
4-wire:	5.0 μ deg/ Ω /degree, up to 100 Ω
Sensor-excitation Current:	0.5 mA
Sensor-break Indication:	Meter displays overrange (three least significant digits blank)
Overvoltage Protection:	25 Vp

NOISE REJECTION

NMR†, SIG HI to SIG LO:	70 dB, 50/60 Hz
CMR†, Analog RTN to PWR GND:	120 dB, DC to 60 Hz
CMV†, Analog RTN to PWR GND:	Dielectric strength to 1500 V transient per 260 Volt rms or DC working voltage.

ACCURACY at 25°C

Range for rated accuracy:	
MC1/MF1:	-200° to +850°C (-328° to +1562°F)
Maximum Error:	$\pm 1.5^{\circ}\text{C}$ ($\pm 2.7^{\circ}\text{F}$) ± 1 count
MC2/MF2:	-199.9° to +199.9°C (-199.9° to +199.9°F)
Maximum Error:	$\pm 0.5^{\circ}\text{C}$ ($\pm 0.5^{\circ}\text{F}$) ± 1 count
Resolution:	0.1°C, 0.1°F, 1°C or 1°F (jumper-selectable)
Span Tempco†:	$\pm 0.02\%$ of reading/ $^{\circ}\text{C}$
Full-Scale Step Response:	1 second
Warmup to Rated Accuracy:	30 minutes

ANALOG OUTPUT (linearized)

Voltage:	1mV/count
Calibration Error:	
MC1/MF1:	$\pm 1\%$ of reading ± 1.5 mV on $^{\circ}\text{C}$, ± 2.7 mV on $^{\circ}\text{F}$
MC2/MF2:	$\pm 1\%$ of reading ± 0.5 mV
Source Resistance:	100 Ω

ANALOG TO DIGITAL CONVERSION

Technique:	Dual-slope, average value
Signal Integration Period:	100 ms
Read Rate:	2.5/s

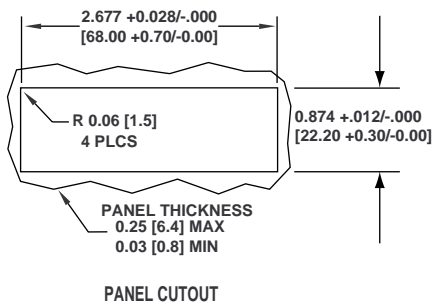
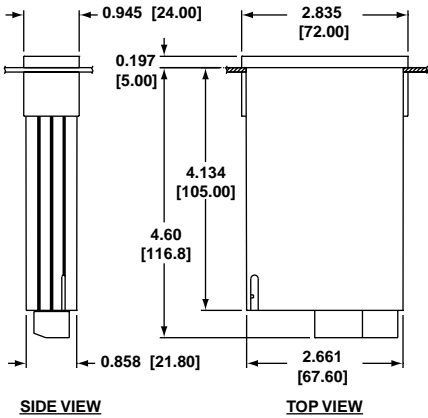

Figure 5-1 Dimensions

SECTION 6 GLOSSARY

COMMON MODE REJECTION (CMR) - a measure of the affect of a voltage on the indicated display. It is the ratio of the common mode voltage to the measured voltage due to a common mode voltage.

COMMON MODE VOLTAGE (CMV) - the average of the voltage applied to both wires of a two wire or differential input.

NORMAL MODE REJECTION (NMR) - a measure of the rejection of unwanted signal due to a voltage applied between the wires of a two wire or differential input (shown as normal mode voltage). NMR is the ratio of the normal mode voltage to the measured voltage due to the normal mode voltage.

TEMPCO - abbreviation for temperature coefficient. It is the effect of changes in ambient temperature on a particular parameter, such as zero or span settings.



WARRANTY/DISCLAIMER

OMEGA ENGINEERING, INC. warrants this unit to be free of defects in materials and workmanship for a period of 13 months from date of purchase. OMEGA Warranty adds an additional one (1) month grace period to the normal one (1) year product warranty to cover handling and shipping time. This ensures that OMEGA's customers receive maximum coverage on each product.

If the unit should malfunction, it must be returned to the factory for evaluation. OMEGA's Customer Service Department will issue an Authorized Return (AR) number immediately upon phone or written request. Upon examination by OMEGA, if the unit is found to be defective it will be repaired or replaced at no charge. OMEGA's WARRANTY does not apply to defects resulting from any action of the purchaser, including but not limited to mishandling, improper interfacing, operation outside of design limits, improper repair, or unauthorized modification. This WARRANTY is VOID if the unit shows evidence of having been tampered with or shows evidence of being damaged as a result of excessive corrosion; or current, heat, moisture or vibration; improper specification; misapplication; misuse or other operating conditions outside of OMEGA's control. Components which wear are not warranted, including but not limited to contact points, fuses, and triacs.

OMEGA is pleased to offer suggestions on the use of its various products. However, OMEGA neither assumes responsibility for any omissions or errors nor assumes liability for any damages that result from the use of its products in accordance with information provided by OMEGA, either verbal or written. OMEGA warrants only that the parts manufactured by it will be as specified and free of defects. OMEGA MAKES NO OTHER WARRANTIES OR REPRESENTATIONS OF ANY KIND WHATSOEVER, EXPRESSED OR IMPLIED, EXCEPT THAT OF TITLE, AND ALL IMPLIED WARRANTIES INCLUDING ANY WARRANTY OF MERCHANTABILITY AND FITNESS FOR A PARTICULAR PURPOSE ARE HEREBY DISCLAIMED. LIMITATION OF LIABILITY: The remedies of purchaser set forth herein are exclusive and the total liability of OMEGA with respect to this order, whether based on contract, warranty, negligence, indemnification, strict liability or otherwise, shall not exceed the purchase price of the component upon which liability is based. In no event shall OMEGA be liable for consequential, incidental or special damages.

CONDITIONS: Equipment sold by OMEGA is not intended to be used, nor shall it be used: (1) as a "Basic Component" under 10 CFR 21 (NRC), used in or with any nuclear installation or activity; or (2) in medical applications or used on humans. Should any Product(s) be used in or with any nuclear installation or activity, medical application, used on humans, or misused in any way, OMEGA assumes no responsibility as set forth in our basic WARRANTY/DISCLAIMER language, and additionally, purchaser will indemnify OMEGA and hold OMEGA harmless from any liability or damage whatsoever arising out of the use of the Product(s) in such a manner.

RETURN REQUESTS / INQUIRIES

Direct all warranty and repair requests/inquiries to the OMEGA Customer Service Department. BEFORE RETURNING ANY PRODUCT(S) TO OMEGA, PURCHASER MUST OBTAIN AN AUTHORIZED RETURN (AR) NUMBER FROM OMEGA'S CUSTOMER SERVICE DEPARTMENT (IN ORDER TO AVOID PROCESSING DELAYS). The assigned AR number should then be marked on the outside of the return package and on any correspondence.

The purchaser is responsible for shipping charges, freight, insurance and proper packaging to prevent breakage in transit.

FOR WARRANTY RETURNS, please have the following information available BEFORE contacting OMEGA:

1. P.O. number under which the product was PURCHASED,
2. Model and serial number of the product under warranty, and
3. Repair instructions and/or specific problems relative to the product.

FOR NON-WARRANTY REPAIRS, consult OMEGA for current repair charges. Have the following information available BEFORE contacting OMEGA:

1. P.O. number to cover the COST of the repair,
2. Model and serial number of product, and
3. Repair instructions and/or specific problems relative to the product.

OMEGA's policy is to make running changes, not model changes, whenever an improvement is possible. This affords our customers the latest in technology and engineering.

OMEGA is a registered trademark of OMEGA ENGINEERING, INC.

© Copyright 1999 OMEGA ENGINEERING, INC. All rights reserved. This document may not be copied, photocopied, reproduced, translated, or reduced to any electronic medium or machine-readable form, in whole or in part, without prior written consent of OMEGA ENGINEERING, INC.

Where Do I Find Everything I Need for Process Measurement and Control? OMEGA...Of Course!

TEMPERATURE

- ☑ Thermocouple, RTD & Thermistor Probes, Connectors, Panels & Assemblies
- ☑ Wire: Thermocouple, RTD & Thermistor
- ☑ Calibrators & Ice Point References
- ☑ Recorders, Controllers & Process Monitors
- ☑ Infrared Pyrometers

PRESSURE, STRAIN AND FORCE

- ☑ Transducers & Strain Gauges
- ☑ Load Cells & Pressure Gauges
- ☑ Displacement Transducers
- ☑ Instrumentation & Accessories

FLOW/LEVEL

- ☑ Rotameters, Gas Mass Flowmeters & Flow Computers
- ☑ Air Velocity Indicators
- ☑ Turbine/Paddlewheel Systems
- ☑ Totalizers & Batch Controllers

pH/CONDUCTIVITY

- ☑ pH Electrodes, Testers & Accessories
- ☑ Benchtop/Laboratory Meters
- ☑ Controllers, Calibrators, Simulators & Pumps
- ☑ Industrial pH & Conductivity Equipment

DATA ACQUISITION

- ☑ Data Acquisition & Engineering Software
- ☑ Communications-Based Acquisition Systems
- ☑ Plug-in Cards for Apple, IBM & Compatibles
- ☑ Datalogging Systems
- ☑ Recorders, Printers & Plotters

HEATERS

- ☑ Heating Cable
- ☑ Cartridge & Strip Heaters
- ☑ Immersion & Band Heaters
- ☑ Flexible Heaters
- ☑ Laboratory Heaters

ENVIRONMENTAL MONITORING AND CONTROL

- ☑ Metering & Control Instrumentation
- ☑ Refractometers
- ☑ Pumps & Tubing
- ☑ Air, Soil & Water Monitors
- ☑ Industrial Water & Wastewater Treatment
- ☑ pH, Conductivity & Dissolved Oxygen Instruments