OPERATOR'S MANUAL

Model CYD201 and CYD208

Digital Thermometer

 **OMEGA**
ENGINEERING, INC.
An OMEGA Technologies Company

WARRANTY

OMEGA warrants this unit to be free of defects in materials and workmanship and to give satisfactory service for a period of 13 months from date of purchase. OMEGA Warranty adds an additional one (1) month grace period to the normal one (1) year product warranty to cover handling and shipping time. This ensures that our Customers receive maximum coverage on each product. If the unit should malfunction, it must be returned to the factory for evaluation. Our Customer Service Department will issue an Authorized Return (AR) Number immediately upon phone or written request. Upon examination by OMEGA, if the unit is found to be defective, it will be repaired or replaced at no charge. However, this WARRANTY is VOID if the unit shows evidence of having been tampered with or shows evidence of being damaged as a result of excessive current, heat, moisture, vibration, or misuse. Components which wear or which are damaged by misuse are not warranted. These include contact points, fuses, and triacs.

THERE ARE NOT WARRANTIES EXCEPT AS STATED HEREIN. THERE ARE NO OTHER WARRANTIES, EXPRESSED OR IMPLIED, INCLUDING BUT NOT LIMITED TO THE IMPLIED WARRANTIES OF MERCHANTABILITY AND OF FITNESS FOR A PARTICULAR PURPOSE. IN NO EVENT SHALL OMEGA ENGINEERING, INC. BE LIABLE FOR CONSEQUENTIAL, INCIDENTAL, OR SPECIAL DAMAGES. THE BUYER'S SOLE REMEDY FOR ANY BREACH OF THIS AGREEMENT BY OMEGA ENGINEERING, INC., OR ANY BREACH OF ANY WARRANTY BY OMEGA ENGINEERING, INC., SHALL NOT EXCEED THE PURCHASE PRICE PAID BY THE PURCHASER TO OMEGA ENGINEERING, INC. FOR THE UNIT OR UNITS OR EQUIPMENT DIRECTLY AFFECTED BY SUCH BREACH.

RETURN REQUESTS / INQUIRIES

Direct all warranty and repair requests/inquiries to the OMEGA Customer Service Department. Call toll free in the USA and Canada: 1-800-622-2378; FAX: 203-359-7811.
International: 203-359-1660; FAX: 203-359-7806.

BEFORE RETURNING ANY PRODUCT(S) TO OMEGA, OBTAIN AN AUTHORIZED RETURN (AR) NUMBER FROM OUR CUSTOMER SERVICE DEPARTMENT IN ORDER TO AVOID PROCESSING DELAYS. The assigned AR number should then be marked on the outside of the return package and on any correspondence.

FOR WARRANTY RETURNS: Please have the following information available BEFORE contacting OMEGA:

1. P.O. Number under which the product was PURCHASED.
2. Model and serial number of the product under warranty.
3. Repair instruction and/or specific problems you are having with the product.

FOR NON-WARRANTY REPAIRS OR CALIBRATIONS: Consult OMEGA for current repair/calibration charges. Have the following information BEFORE contacting OMEGA:

1. Your P.O. Number to cover COST of the repair/calibration..
2. Model and serial number of the product under warranty.
3. Repair instruction and/or specific problems you are having with the product.

Every precaution for accuracy has been taken in the preparation of this manual, however, OMEGA ENGINEERING, INC. neither assumes responsibility for any omissions or errors that may appear nor assumes liability for any damages that result from the use of the products in accordance with the information contained in the manual.

OMEGA policy is to make running changes, not model changes, whenever an improvement is possible. That way, our Customers get the latest in technology and engineering.

OMEGA is a registered trademark of OMEGA ENGINEERING, INC.

© 1998 and 1999 OMEGA ENGINEERING, INC. All rights reserved including illustrations. Nothing in this manual may be reproduced in any manner, either wholly or in part for any purpose whatsoever without written permission from OMEGA ENGINEERING, INC. Printed in U.S.A.

TABLE OF CONTENTS

<i>Chapter/Paragraph</i>	<i>Title</i>	<i>Page</i>
1	INTRODUCTION	1-1
1.0	General.....	1-1
1.1	Model CYD201/CYD208 System Description.....	1-1
1.2	Handling Liquid Helium and Liquid Nitrogen	1-3
1.2.1	Handling Cryogenic Storage Dewars.....	1-3
1.2.2	LHe and LN ₂ Safety Precautions	1-3
1.2.3	Recommended First Aid	1-4
1.3	Electrostatic Discharge.....	1-4
1.3.1	Identifying ESDS Components	1-5
1.3.2	Handling ESDS Components.....	1-5
1.4	Safety Summary.....	1-5
1.5	Safety Symbols.....	1-6
2	INSTALLATION	2-1
2.0	General.....	2-1
2.1	Inspection and Unpacking	2-1
2.2	Repackaging For Shipment.....	2-1
2.3	Power and Ground Requirements	2-2
2.4	Sensor Installation Recommendations.....	2-2
2.4.1	Two-Lead Vs. Four-Lead Measurements.....	2-3
2.4.2	Connecting Leads to the Sensor.....	2-4
2.4.3	Sensor Mounting.....	2-4
2.4.4	Measurement Errors Due to AC Noise.....	2-5
2.5	Sensor Input Connections	2-6
2.6	Sensor Curve Definition.....	2-7
2.7	Rack Mounting.....	2-7
2.8	Initial Power Up Sequence	2-9
2.9	Power Up Errors	2-9
3	OPERATION	3-1
3.0	General.....	3-1
3.1	Units Key	3-1
3.2	Channel Key (Model CYD208 Only)	3-2
3.3	Scan Mode	3-2
3.4	Setting Dwell Times.....	3-2
3.5	Alarm Operation	3-2
3.5.1	Alarm Setpoint	3-2
3.5.2	Latched and Unlatched Alarms.....	3-3
3.5.3	Alarm Fix Function (Model CYD208 Only)	3-3
3.6	SoftCal™ Compensations	3-3
3.6.1	SoftCal™ Calibration Procedure.....	3-4
3.6.2	Verifying SoftCal™ Operation.....	3-5
3.6.3	Erasing SoftCal™ Compensations	3-5

TABLE OF CONTENTS (Continued)

<i>Chapter/Paragraph</i>	<i>Title</i>	<i>Page</i>
4	REMOTE OPERATION	4-1
4.0	General	4-1
4.1	Serial Interface	4-1
4.1.1	Serial Interface Connections	4-1
4.1.2	Serial Interface Operation	4-3
4.1.3	Sample Basic Program	4-3
4.1.4	Sample QuickBasic 4.0 Program	4-4
4.2	Serial Interface Command Summary.....	4-4
5	SERVICE.....	5-1
5.0	General.....	5-1
5.1	Model CYD201 Rear Panel Connections	5-1
5.2	Model CYD208 Rear Panel Connections	5-2
5.3	Error Code Troubleshooting	5-3
5.4	General Maintenance	5-3
5.5	Fuse Replacement	5-4
5.6	Line Voltage Configuration	5-4
5.7	Recalibration.....	5-5
5.7.1	Current Source Calibration.....	5-5
5.7.2	A/D Converter Calibration	5-6
5.8	Serial Interface Cable and Adapters.....	5-6
6	OPTIONS AND ACCESSORIES.....	6-1
6.0	General.....	6-1
6.1	Accessories	6-1
6.2	Wires	6-2
6.3	Sensors	6-3
APPENDIX A – CURVE TABLES		A-1
A1.0	General.....	A-1

LIST OF ILLUSTRATIONS

Figure No.	Title	Page
1-1	Typical Cryogenic Dewar	1-3
2-1	Model CYD201 Sensor Connector J1 Details	2-6
2-2	Model CYD208 Sensor Connector J1 Details	2-6
2-3	Model 2090 Rack Mounting	2-8
3-1	Model CYD201 Front Panel	3-1
3-2	Model CYD208 Front Panel	3-1
4-1	Serial I/O (RJ-11) Connector Pin Definitions	4-2
4-2	Serial Interface Connections.....	4-2
5-1	Model CYD201 Rear Panel Connections.....	5-1
5-2	Model CYD208 Rear Panel Connections.....	5-2
5-3	Line Voltage Jumper Configuration	5-4
5-4	Calibration Connections.....	5-5
5-5	Model CYD200-J10 RJ-11 Cable Assembly Wiring Details.....	5-6
5-6	Model CYD200-D RJ-11 to DB-25 Adapter Wiring Details	5-6
5-7	Model CYD200-B RJ-11 to DE-9 Adapter Wiring Details	5-3
6-1	Serial Interface Adapters	6-3

LIST OF TABLES

Table No.	Title	Page
1-1	Model CYD201/CYD208 Specifications	1-2
2-1	Line Voltage and Fuse Rating Selection.....	2-2
2-2	Model CYD201/CYD208 Temperature Curves	2-7
4-1	Serial Interface Specifications	4-1
A-1	Curve 0 - DT-500DI-8B Voltage-Temp. Characteristics.....	A-1
A-2	Curve 1 - DT-500DI-8A Voltage-Temp. Characteristics.....	A-2
A-3	Curve 2 - DT-500DRC-D Voltage-Temp. Characteristics	A-3
A-4	Curve 3 - DT-500DRC-E1 Voltage-Temp. Characteristics.....	A-4
A-5	Curve 4 - CTI Diode Voltage-Temp. Characteristics.....	A-5
A-6	Curve 5 - DT-500DI-8C Voltage-Temp. Characteristics	A-6
A-7	Curve 6 - CY-7 Voltage-Temp. Characteristics.....	A-7

This Page Intentionally Left Blank

CHAPTER 1

INTRODUCTION

1.0 GENERAL

This chapter covers a general description of the Model CYD201/CYD208 (Paragraph 1.1), Handling Liquid Helium and Liquid Nitrogen (Paragraph 1.2), Electrostatic Discharge (Paragraph 1.3), Safety Summary (Paragraph 1.4), and Safety Symbols (Paragraph 1.5).

Due to the OMEGA commitment to continuous product improvement, modifications may occur to the Model CYD201/CYD208 software with time. Some of these changes result from Customer feedback about operation on various cryogenic systems. We encourage comments or suggestions regarding this instrument. Please return the instrument warranty card to ensure receipt of future software updates.

1.1 MODEL CYD201/CYD208 GENERAL DESCRIPTION

Model CYD201/CYD208 Digital Thermometers are ideal to monitor critical temperatures in chemical and materials research, superconductivity measurements, and low temperature physics. The units feature:

- Broad Temperature Range: 1.4 K to 475 K (–272 °C to 202 °C).
- Single Channel (CYD201) and Eight Channel (CYD208) Models.
- For use with CY-7 Series, DT-500 Series, and other Silicon Diode Sensors.
- System Accuracy (Instrument with Sensor) with SoftCal™ to within ± 0.1 °C or better.
- Temperature display in °C, °F, K, or Sensor Voltage.
- High/Low Alarm Setpoint with Interfacing Alarm Contacts.
- Standard RS-232C Output of Temperature, Input of Settings, and Alarm Status for Remote Operation.

Table 1-1. Model CYD201/CYD208 Specifications

Display: Four-digit LED display

Resolution: 0.1 for values > 100 or < -100
0.01 for values between $-100 < T < 100$

Temperature Range: 1.4 K to 475 K without probe
23 K to 473 K with probe

System Accuracy: To within ± 0.1 K from 177 K to 313 K.
To ± 0.2 K or better from 30 K to 373 K.
 ± 1.0 K above 373 K.

Sensor Excitation: 10 μ A constant current

Repeatability: < 50 mK

Input Range: 0 to 3 volts with a resolution of 0.1 mV

Hi/Lo Alarm Setpoint: 0.1° resolution

Alarm Relay: Single SPDT relay, rated 28 VDC or Peak AC, 0.25 A
(3 W max.)

Scan/Dwell: The Model CYD208 automatically scans all eight channels with selectable dwell times of 0 (skip), 5, 10, 30 and 60 seconds for each channel.

Connections: Four-lead sensor connection (2 current, 2 voltage).

Response Curves*: Standard Curve 10, DT-500DI-8A
(also -8B and -8C), DT-500DRC-D,
DT-500DRC-E1, and CTI Curve C.
* SOFTCAL™ qualified only for CY-7 Series diode sensors.

COMPUTER INTERFACE

Type: RS-232C Serial Three Wire (Refer to Table 4-1).

MECHANICAL

Ambient Temperature Range: 18 to 28 $^\circ$ C (64 to 82 $^\circ$ F),
or 15 to 35 $^\circ$ C (59 to 95 $^\circ$ F) with reduced accuracy.

Power Requirements: 90-125 or 210-250 VAC, 50/60 Hz, 3 watts.

Dimensions: 41 x 106 x 164 mm (1.61 x 4.18 x 6.45 inches).

Weight: 0.5 kilogram (1.1 Pounds)

NOTES

1. Product Specifications subject to change without notice.
2. System electronic temperature accuracy in a given temperature range is the sum of the specifications given for input and output. Sensor calibration errors are not included.

1.2 HANDLING LIQUID HELIUM AND LIQUID NITROGEN

Helium and Nitrogen are colorless, odorless, and tasteless gases. They liquefy when properly cooled. Liquid helium (LHe) and liquid nitrogen (LN₂) may be used in conjunction with the Model CYD201 or CYD208. Although not explosive, there are certain safety considerations in the handling of LHe and LN₂.

1.2.1 Handling Cryogenic Storage Dewars

Operate all cryogenic containers (dewars) in accordance with manufacturer instructions. Safety instructions are normally posted on the side of each dewar. Keep cryogenic dewars in a well-ventilated place, protected from the weather, and away from heat sources. Figure 1-1 shows a typical cryogenic dewar.

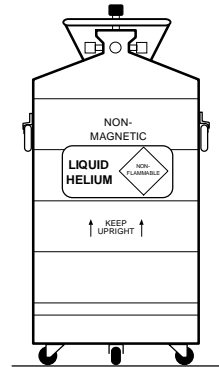

Figure 1-1. Typical Cryogenic Dewar

1.2.2 LHe and LN₂ Safety Precautions

Transfer LHe and LN₂ and operate storage dewar controls in accordance with manufacturer/supplier instructions. During transfer, follow all safety precautions written on the storage dewar and recommended by the manufacturer.

WARNING

- **Liquid helium is a potential asphyxiant and can cause rapid suffocation without warning. Store and use in an adequately ventilated area. DO NOT vent the container in confined spaces. DO NOT enter confined spaces where gas may be present unless area is well-ventilated. If inhaled, remove to fresh air. If not breathing, give artificial respiration. If breathing is difficult, give oxygen. Get medical attention.**
- **Liquid helium can cause severe frostbite to exposed body parts. DO NOT touch frosted pipes or valves. For frostbite, consult a physician immediately. If a physician is unavailable, warm the affected parts with water that is near body temperature.**

Two essential safety aspects of handling LHe are adequate ventilation and eye and skin protection. Although helium and nitrogen gases are non-toxic, they are dangerous because they replace air in a normal breathing atmosphere. Liquid helium is an even greater threat because a small amount of liquid evaporates to create a large amount of gas. Store and operate cryogenic dewars in open, well-ventilated areas.

When transferring LHe and LN₂, protect eyes and skin from accidental contact with liquid or the cold gas issuing from it. Protect eyes with full face shield or chemical splash goggles; safety glasses (even with side shields) are inadequate. Always wear special cryogenic gloves (Tempshield Cryo-Gloves[®] or equivalent) when handling anything that is, or may have been, in contact with the liquid or cold gas, or with cold pipes or equipment. Wear long sleeve shirts and cuffless trousers long enough to prevent liquid from entering shoes.

1.2.3 Recommended First Aid

Post an appropriate Material Safety Data Sheet (MSDS) obtained from the manufacturer/distributor at every site that stores and uses LHe and LN₂. The MSDS specifies symptoms of overexposure and first aid.

If a person exhibits symptoms of asphyxia such as headache, drowsiness, dizziness, excitation, excessive salivation, vomiting, or unconsciousness, remove to fresh air. If breathing is difficult, give oxygen. If breathing stops, give artificial respiration. Call a physician immediately.

If exposure to cryogenic liquids or cold gases occurs, restore tissue to normal body temperature (98.6°F) by bathing it in warm water not exceeding 105 °F (40 °C). DO NOT rub the frozen part, either before or after rewarming. Protect the injured tissue from further damage and infection and call a physician immediately. Flush exposed eyes thoroughly with warm water for at least 15 minutes. In case of massive exposure, remove clothing while showering with warm water. The patient should not drink alcohol or smoke. Keep warm and rest. Call a physician immediately.

1.3 ELECTROSTATIC DISCHARGE

Electrostatic Discharge (ESD) may damage electronic parts, assemblies, and equipment. ESD is a transfer of electrostatic charge between bodies at different electrostatic potentials caused by direct contact or induced by an electrostatic field. The low-energy source that most commonly destroys Electrostatic Discharge Sensitive (ESDS) devices is the human body, which generates and retains static electricity. Simply walking across a carpet in low humidity may generate up to 35,000 volts of static electricity.

Current technology trends toward greater complexity, increased packaging density, and thinner dielectrics between active elements, which results in electronic devices with even more ESD sensitivity. Some electronic parts are more ESDS than others. ESD levels of only a few hundred volts may damage electronic components such as semiconductors, thick and thin film resistors, and piezoelectric crystals during testing, handling, repair, or assembly. Discharge voltages below 4000 volts cannot be seen, felt, or heard.

1.3.1 Identifying ESDS Components

Below are some industry symbols used to label components as ESDS:



1.3.2 Handling ESDS Components

Observe all precautions necessary to prevent damage to ESDS components before installation. Bring the device and everything that contacts it to ground potential by providing a conductive surface and discharge paths. At a minimum, observe these precautions:

1. De-energize or disconnect all power and signal sources and loads used with unit.
2. Place unit on a grounded conductive work surface.
3. Ground technician through a conductive wrist strap (or other device) using 1 M Ω series resistor to protect operator.
4. Ground any tools, such as soldering equipment, that will contact unit. Contact with operator's hands provides a sufficient ground for tools that are otherwise electrically isolated.
5. Place ESDS devices and assemblies removed from a unit on a conductive work surface or in a conductive container. An operator inserting or removing a device or assembly from a container must maintain contact with a conductive portion of the container. Use only plastic bags approved for storage of ESD material.
6. Do not handle ESDS devices unnecessarily or remove from the packages until actually used or tested.

1.4 SAFETY SUMMARY

Observe these general safety precautions during all phases of instrument operation, service, and repair. Failure to comply with these precautions or with specific warnings elsewhere in this manual violates safety standards of design, manufacture, and intended instrument use. OMEGA assumes no liability for Customer failure to comply with these requirements.

Ground The Instrument

To minimize shock hazard, connect instrument chassis and cabinet to an electrical ground. The instrument comes with a 3-conductor AC power cable. Plug it into an approved three-contact electrical outlet or use a three-contact adapter with the green ground wire firmly secured to an electrical ground (safety ground) at the power outlet. The power cable jack and mating plug meet Underwriters Laboratories (UL) and International Electrotechnical Commission (IEC) safety standards.

Do Not Operate In An Explosive Atmosphere

Do not operate the instrument in the presence of flammable gases or fumes. Operation of any electrical instrument in such an environment constitutes a definite safety hazard.

Keep Away From Live Circuits

Operating personnel must not remove instrument covers. Refer component replacement and internal adjustments to qualified maintenance personnel. Do not replace components with power cable connected. To avoid injuries, always disconnect power and discharge circuits before touching them.

Do Not Substitute Parts Or Modify Instrument

Do not install substitute parts or perform any unauthorized modification to the instrument. Return the instrument to an authorized OMEGA Cryotronics, Inc. representative for service and repair to ensure that safety features are maintained.

1.5 SAFETY SYMBOLS



Direct current (power line).



Alternating current (power line).



Alternating or direct current (power line).



Three-phase alternating current (power line).



Earth (ground) terminal.



Protective conductor terminal.



Frame or chassis terminal.



On (supply)



Off (supply)



Equipment protected throughout by double insulation or reinforced insulation (equivalent to Class II of IEC 536 - see annex H).



Caution: High voltages or temperatures. Background color: Yellow; Symbol and outline: Black.



Caution or Warning - See instrument documentation. Background color: Yellow; Symbol and outline: Black.

CHAPTER 2

INSTALLATION

2.0 GENERAL

This chapter covers Inspection and Unpacking (Paragraph 2.1), Repackaging for Shipment (Paragraph 2.2), Sensor Installation Recommendations (Paragraph 2.3) Power and Ground Requirements (Paragraph 2.4), Sensor Curve Definitions (Paragraph 2.5), and Rack Mounting (Paragraph 2.6).

2.1 INSPECTION AND UNPACKING

Remove packing list and verify receipt of all equipment. For question about the shipment, please call OMEGA Customer Service Department at 1-800-622-2378 or (203) 359-1660.

Upon receipt, inspect container and equipment for damage. Note particularly any evidence of freight damage. Immediately report any damage to the shipping agent

NOTE: The carrier will not honor any claims unless all shipping material is saved for their examination. After examining and removing contents, save packing material and carton in the event reshipment is necessary.

2.2 REPACKAGING FOR SHIPMENT

To return the Model CYD201/CYD208, sensor, or accessories for repair or replacement, obtain a Authorized Return (AR) number from Technical Service in the United States, or from the authorized sales/service representative from which the product was purchased. Instruments may not be accepted without a RGA number. When returning an instrument for service, OMEGA must have the following information before attempting any repair.

1. Instrument model and serial number.
2. User name, company, address, and phone number.
3. Malfunction symptoms.
4. Description of system.
5. Authorized Return (AR) number.

Repack the system in its original container (if available). Write AR number on the outside of the container or on the packing slip. If not available, consult OMEGA for shipping and packing instructions.

2.3 POWER AND GROUND REQUIREMENTS

The Model CYD201/CYD208 requires a power source of 90 to 125 or 210 to 250 VAC, 50 or 60 Hz, single phase, 3 Watts. Three-prong detachable power cord for 120 VAC operation included. Connect to rear panel UL/IEC/ICEE standard plug. See Table 2-1 for fuse rating.

WARNING: To prevent electrical fire or shock hazards, do not expose this instrument to rain or excess moisture.

CAUTION: Verify proper fuse installation and AC Line Voltage Selection Wheel on the Model CYD201/CYD208 rear panel set to available AC line voltage before inserting power cord and turning on the instrument. Refer to Chapter 5 to change voltage configuration.

NOTE: Do not attach the shield to earth ground at the sensor end. It may introduce noise at the measurement end.

Table 2-1. Line Voltage and Fuse Rating Selection

Select	Range	Fuse
115	90 – 125 VAC	0.2 A (Slow Blow)
230	210 – 250 VAC	0.1 A (Slow Blow)

To protect operating personnel, the National Electrical Manufacturer's Association (NEMA) recommends, and some local codes require, grounded instrument panels and cabinets. The 3-conductor power cable, when plugged into an appropriate receptacle, grounds the instrument.

Grounding and shielding signal lines are major concerns when setting up any precision instrument or system. The CYD201/CYD208 includes ground isolation of sensor excitation to allow 4-wire measurement of diode voltage and resistance. Improperly grounding sensor leads and shields can defeat this feature.

Model CYD201/CYD208 digital logic ties directly to earth ground for interface communication. The low side of the heater output connects directly to earth ground. Shield sensor cables whenever possible. Attach the shields to the connector shield pin.

2.4 SENSOR INSTALLATION RECOMMENDATIONS

See the OMEGA Product Catalog for sensor installation and specifications. Call OMEGA for copies of application notes or sensor installation questions. Below are general recommendations on sensor installation:

1. Do not ground the sensor.
2. Shield leads and connect shield wire to SHIELD on screw terminal connector only. Do not connect shield at other end of cable.

3. Keep leads as short as possible.
4. Use twisted-pair wire. Use Duo-Twist™ wire (or equivalent) for two-wire, or Quad-Twist™ wire (or equivalent) for four-wire applications.
5. Thermally anchor lead wires.

2.4.1 Two-Lead Vs Four-Lead Measurements

In two-lead measurement, the leads that measure sensor voltage also carry the current. The voltage measured at the instrument is the sum of the temperature sensor voltage and the IR voltage drop within the two current leads. Since heat flow down the leads can be critical in a cryogenic environment, wire of small diameter and significant resistance per foot is preferred to minimize this heat flow. Consequently, a voltage drop within the leads may exist.

Four-lead measurement confines current to one pair of leads and measures sensor voltage with the other lead pair carrying no current.

2.4.1.1 Two-Lead Measurement

Sometimes system constraints dictate two-lead measurement. Connect the positive terminals (V+ and I+) together and the negative terminals (V- and I-) together at the instrument, then run two leads to the sensor.

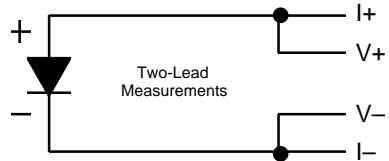

Expect some loss in accuracy; the voltage measured at the voltmeter equals the sum of the sensor voltage and the voltage drop across the connecting leads. The exact measurement error depends on sensor sensitivity and variations resulting from changing temperature. For example, a 10 Ω lead resistance results in a 0.1 mV voltage error. The resultant temperature error at liquid helium temperature is only 3 mK, but, because of the lower sensitivity (dV/dT) of the diode at higher temperatures, it becomes 10 mK at liquid nitrogen temperature.

2.4.1.2 Four-Lead Measurement

All sensors, both two-lead and four-lead devices, can be measured in a four-lead configuration to eliminate the effects of lead resistance. The exact point at which the connecting leads solder to the two-lead sensor normally results in a negligible temperature uncertainty.

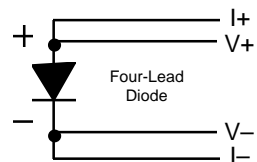

2.4.2 Connecting Leads To The Sensor

Excessive heat flow through connecting leads to any temperature sensor may differ the temperature between the active sensing element and the sample to which the sensor mounts. This reflects as a real temperature offset between what is measured and the true sample temperature. Eliminate such temperature errors with proper selection and installation of connecting leads.

To minimize heat flow through the leads, select leads of small diameter and low thermal conductivity. Phosphor-bronze or Manganin wire is commonly used in sizes 32 or 36 AWG. These wires have a fairly low thermal conductivity, yet electrical resistance is not large enough to create measurement problems.

Thermally anchor lead wires at several temperatures between room temperature and cryogenic temperatures to guarantee no heat conduction through the leads to the sensor.

2.4.3 Sensor Mounting

Before installing a diode sensor, identify which lead is the anode and which is the cathode. When viewed with the base down and the leads towards the observer, the anode is on the right and the cathode is on the left. The OMEGA CY-7-SD silicon diode sensor lead configuration is shown to the right. For other sensors, read accompanying literature or consult the manufacturer to positively identify sensor leads. Lead identification should remain clear even after sensor installation. Record the sensor serial number and location.

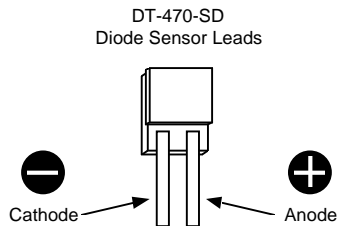

On the CY-7-SD, the base is the largest flat surface. It is sapphire with gold metalization over a nickel buffer layer. The base is electrically isolated from the sensing element and leads; make all thermal contact to the sensor through the base. A thin braze joint around the sides of the SD package electrically connect to the sensing element. Avoid contact to the sides with any electrically conductive material.

When installing the sensor, make sure there are no electrical shorts or current leakage paths between the leads or between the leads and ground. If IMI-7031 varnish or epoxy is used, it may soften varnish-type lead insulations so that high resistance shunts appear between wires if *sufficient time for curing is not allowed*.

Slide Teflon[®] spaghetti tubing over bare leads when the possibility of shorting exists. Avoid putting stress on the device leads and allow for thermal contractions that occur during cooling which could fracture a solder joint or lead if installed under tension at room temperature.

For temporary mounting in cold temperature applications, apply a thin layer of Apiezon[®] N Grease between the sensor and sample to enhance thermal contact under slight pressure. The preferred method for mounting the CY-7-SD sensor is the OMEGA CO Adapter.

CAUTION: OMEGA will not warranty replace any device damaged by user-designed clamps or solder mounting.

For semi-permanent mountings, use Stycast epoxy instead of Apiezon[®] N Grease. **NOTE:** Do not apply Stycast epoxy over the CY-7-SD package: sensor stress may shift the readings. In all cases, periodically inspect the sensor mounting to verify good thermal contact to the mounting surface is maintained.

2.4.4 Measurement Errors Due To AC Noise

Poorly shielded leads or improperly grounded measurement systems can introduce AC noise into the sensor leads. In diode sensors, the AC noise shifts the DC voltage measurement due to the diode non-linear current/voltage characteristics. When this occurs, measured DC voltage is too low and the corresponding temperature reading is high. The measurement error can approach several tenths of a kelvin. To determine if this problem exists, perform either procedure below.

1. Place a capacitor across the diode to shunt induced AC currents. Capacitor size depends on the noise frequency. If noise is related to power line frequency, use a 10 μF capacitor. If AC-coupled digital noise is suspected (digital circuits or interfaces), use a 0.1 to 1 μF capacitor. In either case, if measured DC voltage increases, there is induced noise in the measurement system.
2. Measure AC voltage across the diode with an AC voltmeter or oscilloscope. Most voltmeters do not have the frequency response to measure noise associated with digital circuits or interfaces (which operate in the MHz range). For a thorough discussion of this potential problem, and the magnitude of error which may result, request the paper "Measurement System-Induced Errors In Diode Thermometry," J.K. Krause and B.C. Dodrill, Rev. Sci. Instr. 57 (4), 661, April, 1986.

To greatly reduce potential AC noise, connect twisted leads (pairs) between the measurement instruments and the diode sensors. Use 32 or 36 AWG OMEGA Duo-Twist[™] Cryogenic Wire, which features phosphor bronze wire twisted at 3.15 twists per centimeter (8 twists per inch). See the OMEGA Product Catalog or contact OMEGA for further information.

2.5 SENSOR INPUT CONNECTIONS

The Model CYD201 has one rear panel 4-pin sensor input connector designated J1 INPUT 1. The connector pins, numbered 1 thru 4, are shown below.

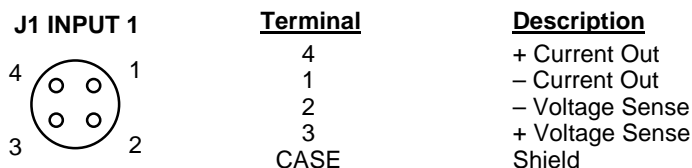

Figure 2-1. Model CYD201 Sensor Connector J1 Details

The Model CYD208 has a 36-pin “Miniature-D” style connector designated J1 INPUTS for inputs 1 thru 8. A Model CYD208-D connector is included to solder interfacing connections to J1. The pin configuration of the Model CYD208-D is shown below.

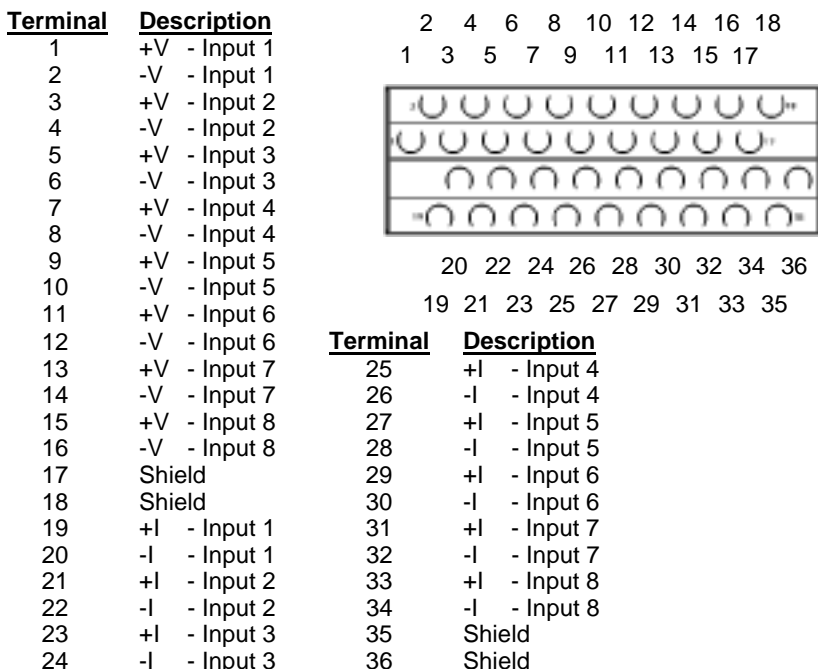

Figure 2-2. Model CYD208-D Sensor Connector Details

2.6 SENSOR CURVE DEFINITION

To display accurate temperature, select a response curve that matches the installed sensor. There are seven standard curves stored within the Model CYD201/CYD208 numbered 0 through 6 (see Appendix A). Different curves may be assigned to each channel of the Model CYD208. Find the unit factory curve configuration inside the front cover of this manual. Curve 6 (CY-7 Curve 10) is the standard curve configuration unless specified differently upon order.

To determine current curve selection, press and hold **UNITS** and turn on (1) the rear panel SET switch (DIP switch 3). Release **UNITS** key. The CYD201 displays the curve number in the display window. The Model CYD208 displays the curve number in the display window and the channel number in the channel window. To display curves for other channel numbers in the Model CYD208, press **CHANNEL** to scroll through the eight channels.

To change the curve, press **UNITS**. The instrument scrolls through curves 0 through 6. In the Model CYD208, press **CHANNEL** to select other channels, then press **UNITS** to scroll through the curves.

After the new curve selection, turn the SET switch on the rear panel off (0). The unit returns to normal operation.

Table 2-2. Model CYD201/CYD208 Temperature Curves

Curve No.	Range (K)	Description
0	0 – 324.9	DT-500DI-8B
1	0 – 324.9	DT-500DI-8A
2	0 – 324.9	DT-500DRC-D
3	0 – 324.9	DT-500TDC-E1
4	0 – 324.9	CTI Curve C
5	0 – 324.9	DT-500DI-8C
6	0 – 474.9	CY-7 Curve 10

2.7 RACK MOUNTING

The Models CYD201 and CYD208 can install in a standard “size” 1/4 panel EIA rack space. If you ordered a CYD208-DIN rack mounting adapter, follow the installation instructions below. See Figure 2-3.

1. Remove front feet on bottom of unit and attach lower rack piece by threading two of the four screws provided into the front feet holes.
2. Locate the two mounting hole access covers on the top of the unit. Attach the other rack with the remaining screws.

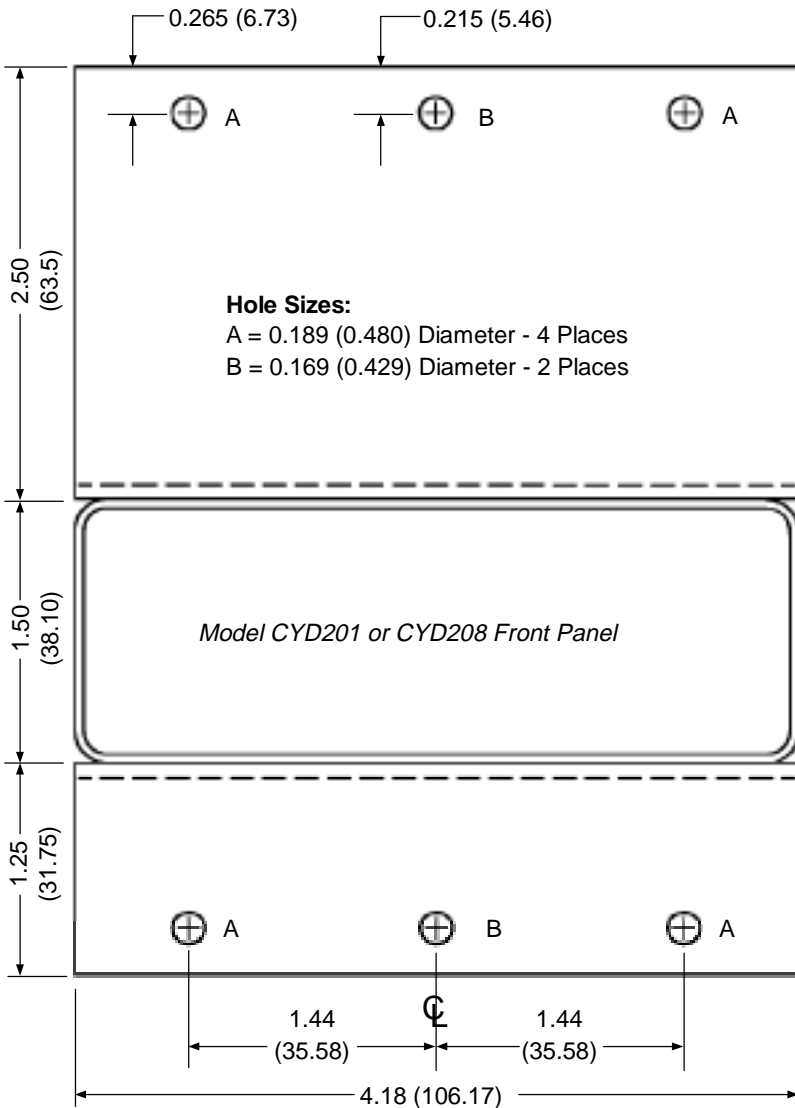

Figure 2-3. Model CYD208-DIN Rack Mounting

2.8 INITIAL POWER UP SEQUENCE

The test sequence below occurs at power up.

1. All display segments light.
2. The unit displays "-201-" or "-208-".
3. The instrument begins normal operation. Units currently selected flash. Model CYD208s also indicate the current channel selected.

2.9 POWER UP ERRORS

On power up, the CYD201/CYD208 checks internal memory. If a problem exists, an error message displays on the front panel of the instrument.

"Er01" indicates a hardware problem in the instrument memory. This error is not user-correctable. First perform the procedure in Paragraph 5.3. If unsuccessful, then call the factory.

"Er02" indicates a soft error in the instrument memory. To correct this error, close dip switch 1 on the rear panel for at least 5 seconds, then open it. Follow the calibration procedure described in Paragraph 5.3 after an error 2 reset.

"OL" indicates a voltage input overload. This can be caused by an open sensor or diode sensor wired backwards.

This Page Intentionally Left Blank

CHAPTER 3

OPERATION

3.0 GENERAL

This chapter covers the Units Key (Paragraph 3.1), the Channel key (Paragraph 3.2), Scan Mode (Paragraph 3.3), Setting Dwell Times (Paragraph 3.4), Alarm Operation (Paragraph 3.5), SoftCal™ Compensations (Paragraph 3.6), Calibration (Paragraph 3.7), Verifying SoftCal™ Operation (Paragraph 3.8), and Erasing SoftCal™ Compensations (Paragraph 3.9).

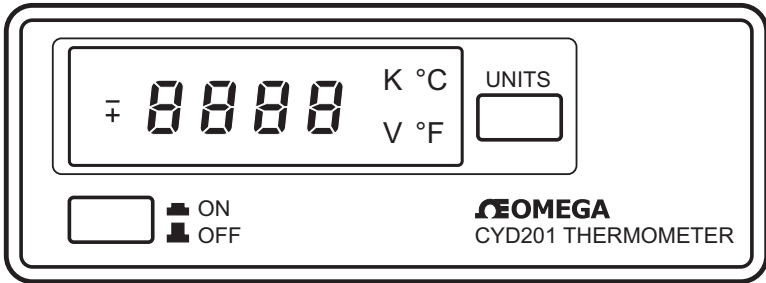

Figure 3-1. Model CYD201 Front Panel

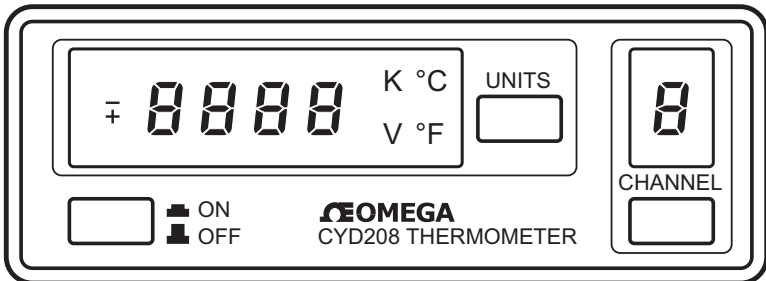

Figure 3-2. Model CYD208 Front Panel

3.1 UNITS KEY

UNITS selects different units of measurement. The thermometer reads in voltage or temperature (°C, °F, or K). Press **UNITS** to scroll through the various selections.

UNITS also determines if SoftCal™ is active. Press and hold **UNITS** for 3 seconds. If SoftCal™ is not active, -000- appears in the display.

3.2 CHANNEL KEY (Model CYD208 Only)

CHANNEL scrolls through the eight possible sensor channels. It also determines if scan mode is activated. Hold 1 to 2 seconds to toggle scan mode On or Off. A red light glows in the upper left channel display if scan mode is active.

3.3 SCAN MODE (Model CYD208 Only)

The thermometer can scan 8 channels or monitor 1 channel. To enable scan mode, press **CHANNEL** for 1 to 2 seconds to toggle scan mode On or Off. If a light appears in upper left of channel display window, then scan mode is On. If the light does not appear, the thermometer is in single-channel mode. Repeat action to reverse mode.

3.4 SETTING DWELL TIMES (Model CYD208 Only)

Set the time the thermometer pauses on each channel (dwell) for 5, 10, 30, or 60 seconds. A dwell time of 0 instructs the thermometer to skip that particular channel. To set the dwell:

1. Hold **CHANNEL** for 3 seconds. Do not release.
2. While still pressing **CHANNEL**, use **UNITS** to select the desired time; 0 (skip), 5, 10, 30, or 60 seconds.
3. Repeat procedure for each desired channel. Default channel dwell is 5 seconds.

3.5 ALARM OPERATION

This section covers Alarm Setpoint (Paragraph 3.5.1), Latched and Unlatched Alarms (Paragraph 3.5.2.), and the Alarm Fix Function (Paragraph 3.5.3).

3.5.1 Alarm Setpoint

The alarm setpoint is a temperature which activates the alarm relay. Set it to warn of temperatures rising above (high alarm) or falling below (low alarm) a certain point.

NOTE: Alarm setpoints work for temperatures, not voltage. If in voltage mode while setting an alarm setpoint, the thermometer defaults to kelvin for the alarm setpoint.

To display the alarm setpoint, move the SET switch on the rear panel to position 1. To change the setpoint:

1. Make sure the SET switch is in position 1.

2. Hold **UNITS** until the desired temperature displays. **UNITS** is a toggle; if it is released and pressed again, the temperature direction reverses. If the temperature display increases, the alarm is a high setpoint. If the temperature display decreases, the alarm is a low setpoint.
3. Release **UNITS** when the desired setpoint displays. For a Model CYD208, press **CHANNEL** to display the desired channel in the channel window and repeat the steps above to set the alarm for each channel
4. Move the **SET** switch back to position 0 to enable the alarm. When it triggers, an alarm status light appears in the upper left of the temperature display.

The alarm can be connected to another device which triggers when the alarm activates. The 3-contact terminal block is present on the rear panel as J3 ALARM. The alarm contacts are designated 1 COM 2 with 1 representing the normally open state and 2 representing the normally closed state.

3.5.2 Latched And Unlatched Alarms

Alarms are either latched or unlatched. The alarm is latched when the **LATCH** switch is in position 1: the alarm turns On when triggered by the alarm setpoint, but will *not* automatically turn Off when the temperature returns to within the high and low setpoint range. The alarm is unlatched when the **LATCH** switch is in position 0; the alarm turns On when triggered by the alarm setpoint, and automatically turns Off when temperatures return to within the high and low setpoint range.

3.5.3 Alarm Fix Function (Model CYD208 Only)

Set the **FIX** switch on the Model CYD208 rear panel to OFF (position 0) to continuously update the alarm relay, depending on the alarm setpoint and sensor temperature. If the **FIX** switch is ON (position 1), the relay updates only when channel 1 input is active.

3.6 SOFTCAL™ COMPENSATIONS

SoftCal™ is a simple, instrument-configured software calibration that improves system accuracy over a specified temperature range. It reduces the error between a CY-7 diode and the Standard Curve 10 used by the instrument. In short, SoftCal™ generates inexpensive calibrations for CY-7 sensors used with OMEGA temperature controllers and monitors.

SoftCal™ calibrations are made at three temperature points: liquid helium (4.2 K), liquid nitrogen (about 77 K), and 305 K. Below is the accuracy* of the CY-7-SD-13 sensor:

±0.5 K	2 K to <30 K	±0.25 K	345 K to <375 K
±0.25 K	30 K to <60 K	±1.0 K	375 K to 475 K
±0.15 K	60 K to <345 K		

* These values generally apply to all silicon diode sensors. Only two-point SoftCal™ calibrations appropriate for CY-7 series Band 11, 11A sensors.

This section covers the SoftCal™ Calibration Procedure (Paragraph 3.6.1), Verifying SoftCal™ Operation (Paragraph 3.6.2), and Erasing SoftCal™ Compensations (Paragraph 3.6.3).

3.6.1 SoftCal™ Calibration Procedure

1. Turn on thermometer 30 minutes prior to operation.
2. Place the SET switch in position 1.
3. Hold **UNITS** until 0 kelvin (or equivalent in °C or °F) displays. The key acts as a toggle. If the display rises, release and press again.
4. Press **CAL ENABLE** on rear panel with a pen tip. The display reads "-SOF-" to indicate the unit is ready to erase the current SoftCal™ calibration. Within 2 seconds press **UNITS** again. The temperature display changes from "-SOF-" to the current SoftCal™ setting.
5. Hold **UNITS** until the sensor temperature displays. For example, if setting SoftCal™ for liquid helium, the display reads 4.2 K. If setting for ice point, the display reads 0 °C.
6. Verify sensor stabilization at calibration temperature.
7. Press **CAL ENABLE** again. "-SOF-" again displays to indicate the unit is ready to accept the calibration point. Within 2 seconds, press **UNITS** to enter a new calibration point. (If **UNITS** is not pressed within 2 seconds, the display returns to the alarm temperature). After 15 seconds, the alarm setpoint temperature displays.
8. To enter more than one point, go back to step 5. **NOTE:** One point may be entered between 1.4 K to 9.9 K. No point may be entered between 10 K and 40 K. Two points may be entered above 40 K.
9. Return the SET switch to position 0.

3.6.2 Verifying SoftCal™ Operation

Check the status of SoftCal™ by holding **UNITS** for 2-3 seconds. If SoftCal™ is not in operation, "-000-" displays.

If the first digit of the display is 1, SoftCal™ is set for below 28 K. If either the second or third digit is 1, SoftCal™ is set for above 28 K.

3.6.3 Erasing SoftCal™ Compensations

When SoftCal™ compensations are erased, the thermometer returns to normal operation.

1. Move the SET switch to position 1.
2. Hold **UNITS** until the front panel displays 0. This key is a toggle. If the display moves in the wrong direction, release and press again.
3. Press **CAL ENABLE** on rear panel using a pen tip. The display changes from 0 to "-SOF-". The alarm setpoint displays after erasing SoftCal™ compensation.
4. Move the SET switch to position 0.

This Page Intentionally Left Blank

CHAPTER 4

REMOTE OPERATION

4.0 GENERAL

The Model CYD201/CYD208 Digital Thermometer Serial Interface can be used for both operation and service. This chapter covers the Serial Interface (Paragraph 4.1) and Serial Interface Commands (Paragraph 4.2).

4.1 SERIAL INTERFACE

The Model CYD201/CYD208 has a serial interface for RS-232C communications with a host computer. RS-232C is an unbalanced (single ended), non-terminated line used over short distances (typically 10 feet or less). The Model CYD201/CYD208 serial interface complies with the electrical format of the RS-232C Interface Standard. The serial interface connector is a standard 6 wire RJ-11 modular (telephone) jack.

This section covers Serial Interface Specifications (Table 4-1), Serial Interface Connections (Paragraph 4.1.1), Serial Interface Hardware Configuration and Adapters (Figures 4-1 & 4-2), Serial Interface Operation (Paragraph 4.1.2), and Sample Basic and QuickBasic Programs (Paragraphs 4.1.3 & 4.1.4 respectively).

Table 4-1. Serial Interface Specifications

Transmission:	Three-Wire
Connector:	RJ-11 Modular (Telephone) Socket
Timing Format:	Asynchronous
Transmission Mode:	Half Duplex
Baud Rate:	300
Bits per Character:	1 Start, 7 Data, 1 Parity, 1 Stop
Parity Type:	Odd
Data Interface Levels:	Transmits/Receives Using EIA Levels
Terminator:	LF (0AH)

4.1.1 Serial Interface Connections

The serial interface connector is a standard 6 wire RJ-11 modular (telephone) jack. OMEGA Model CYD200-J10 data cables, which maintain pin 1 polarity, simplify interconnection. OMEGA offers the Model CYD200-D RJ-11 to DB-25 adapter and Model CYD200-B RJ-11 to DE-9 adapter to connect to the host computer. See Figure 4-2.

J2 SERIAL I/O

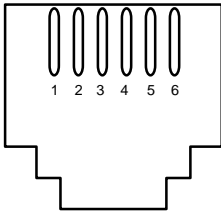

PIN	DESCRIPTION
1	RS-232C In (RxD)
2	RS-232C In (RxD)
3	RS-232C Ground
4	RS-232C Ground
5	RS-232C Out (TxD)
6	RS-232C Out (TxD)

Figure 4-1. Serial I/O (RJ-11) Connector Pin Definitions

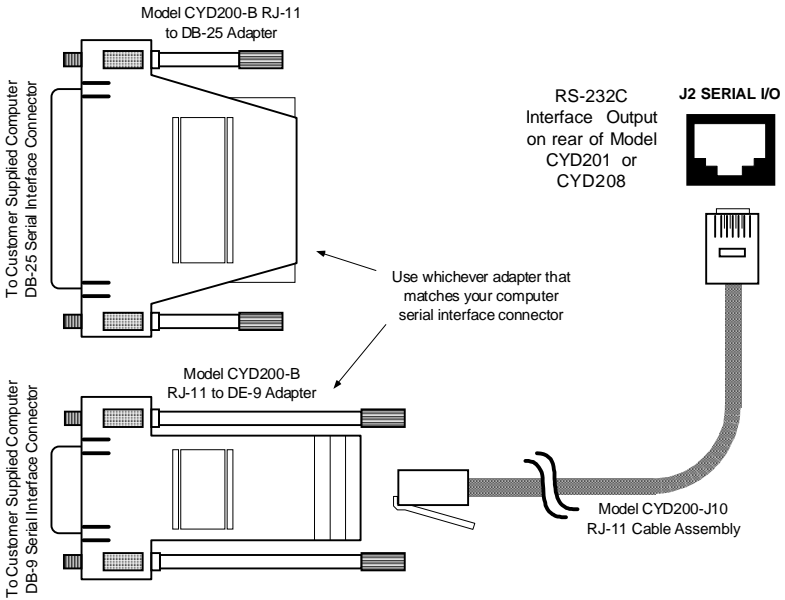

Figure 4-2. Serial Interface Connections

4.1.2 Serial Interface Operation

Remotely control all thermometer functions, except SoftCal™ compensations from a computer with communications software and modem. Located on the rear panel is a RJ-11 modular socket designated J2 SERIAL I/O for host computer connection. Accessories CYD200-J10 (RS-232C phone cord) and CYD200-D (RJ-11 to DB-25 adapter), as well as a null modem adapter may be required to link the serial port of the host computer directly to the thermometer. When programming a Model CYD201/CYD208 from the serial interface, consider the following:

- Type commands in all CAPS.
- The term **free field** indicates a floating decimal point placed any appropriate place in the string of digits.
- **[term]** in examples indicates terminating characters placed by the user or where they appear on a returning character string from the unit.
- Leading zeros and zeros following a decimal point are not needed in a command string, but they are sent in response to a query.
- Enter temperature to 0.1 degrees. Greater precision truncates. Temperature is limited from 0 to 475 K.
- Place no space between commands and the variable being sent.

4.1.3 Sample Basic Program

10 OPEN "COM1:300,0,7,1,RS" AS #1	'Open COM port
11 PRINT "TYPE 'QUIT' TO EXIT"	'Print QUIT message
12 PRINT	'Print blank line
20 INPUT "ENTER COMMAND";A\$	'Get command to send
21 IF A\$ = "QUIT" THEN GOTO 100	'Look for QUIT then quit
30 A\$ = A\$ +CHR\$(13)+CHR\$(10)	'Adding CR and LF
40 PRINT #1,A\$;	'Sending command string
45 R = INSTR(A\$,"W")	'Scan CMD for W/QUERRY
46 IF R = 0 THEN GOTO 90	'If not a QUERRY skip PRINT
50 FOR Z = 1 TO 500: NEXT Z	'Short delay
60 LINE INPUT#1,B\$	'Read back CYD201/CYD208 response
70 PRINT B\$;	'PRINT instrument response
90 GOTO 11	'Jump back to the beginning
100 CLOSE #1	'Close COM port
101 END	'End program

4.1.4 Sample Quick Basic 4.0 Program

```

STARTUP: OPEN "COM1:300,0,7,1,RS" FOR RANDOM AS #1
          'open the serial port
          PRINT "TYPE 'QUIT' TO EXIT"      'print 'QUIT' message
RESTART: PRINT                               'print blank line
          INPUT "ENTER COMMAND"; A$        'get command to send
          IF A$ = "QUIT" THEN GOTO FINISH  'check for quit request
          A$ = A$ + CHR$(13) + CHR$(10)    'adding CR and LF
          PRINT #1, A$;                    'sending command string
          R = INSTR(A$, "W")               'scan for W/query
          IF R = 0 THEN GOTO REJUMP        'if not query skip print
          FOR Z = 1 TO 500: NEXT Z         'short delay
          LINE INPUT #1, B$                'read back CYD201/CYD208 response
          PRINT B$;                        'print instrument response
REJUMP:   GOTO RESTART                    'jump back to beginning
FINISH:   CLOSE #1                         'close serial port
          END                               'end/exit program
    
```

4.2 SERIAL INTERFACE COMMAND SUMMARY

<u>Command</u>	<u>Function</u>	<u>Command</u>	<u>Function</u>
F0	Sensor Units for Setpoint	Y	Scan Dwell Time *
H	High Alarm Setpoint	YC	Scanner Channel Selection *
L	Low Alarm Setpoint	YH	Scan Disable *
R	Reset Alarm	YS	Scan Enable *
WA	Switch ID & Alarm Data Query	WY	Scan and Dwell Query *
WS	Sensor Reading & Alarm Status Query		

* Model CYD208 Only.

Below is an explanation of the command list structure.

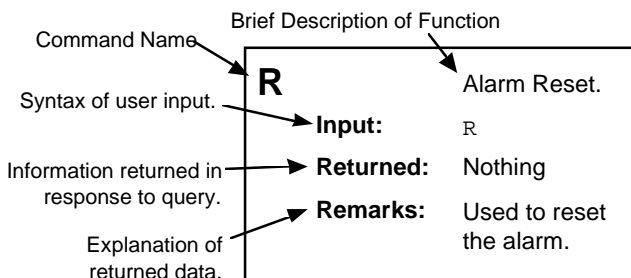

F0 Sets Sensor Units for Temperature Display.

Input: F0x

Returned: Nothing

Remarks: Sets sensor units for the temperature display, where **x** = **C** (Celsius), **F** (Fahrenheit), **K** (kelvin), or **V** (volts).

H Select High Alarm Setpoint Value.

Input: Hxxx.x

Returned: Nothing

Remarks: Sets high alarm setpoint, where **xxx.x** = temperature setpoint in units specified by F0 command. If the instrument is set for volts, the alarm defaults to kelvin.

Example: H300[term] sets a high alarm setpoint of 300 degrees.

L Select Low Alarm Setpoint Value.

Input: Lxxx.x

Returned: Nothing

Remarks: Sets low alarm setpoint, where **xxx.x** = temperature setpoint in units specified by F0 command. If the instrument is set for volts, the alarm defaults to kelvin.

Example: L31.2[term] sets a low alarm setpoint of 31.2 degrees.

R Alarm Reset.

Input: R

Returned: Nothing

Remarks: Resets the alarm.

Y Channel Dwell Time (**Model CYD208 Only**).

Input: Yab

Returned: Nothing

Remarks: Sets dwell time for a given channel, where **a** = channel 1 - 8, and **b** = the dwell time parameter as follows:

0 = zero seconds, **1** = 5 seconds, **2** = 10 seconds,

3 = 30 seconds, **4** = 60 seconds

Setting a dwell time of 0 skips the specified channel in the sequence.

Example: Y23[term] sets the dwell time for channel 2 to 30 seconds.

YC Channel Scanner Channel (**Model CYD208 Only**).

Input: ΥCx

Returned: Nothing

Remarks: Asynchronously selects a scanner channel for readout independent of scan feature, where x = channel 1 - 8.

YH End Scanning (**Model CYD208 Only**).

Input: ΥH

Returned: Nothing

Remarks: Halts input scan at current input channel. Place scanner on hold when sending any other commands to scanner or unpredictable results may occur.

YS Begin Scanning (**Model CYD208 Only**).

Input: Υs

Returned: Nothing

Remarks: Starts input scan from current input channel. The instrument skips every channel with a dwell time of zero.

WA Switch ID and Alarm Data.

Input: wA

Returned: For a Model CYD201, returns:
[switch ID],[high or low alarm],[alarm sign],[alarm setpoint](CR)(LF)

For a Model CYD208, returns:
[switch ID],[high or low alarm],[alarm sign],[alarm setpoint],[active channel number](CR)(LF)

Remarks: Provides the switch ID and alarm data. The switch ID parameter is 0 through 3 for the Model CYD201. It is the sum of 1 if the alarm set enable is set, plus 2 if relay latching is desired. The switch ID parameter is 0 through 7 for the Model CYD208. It is the sum of 1 if the alarm set enable is set, plus 2 if relay latching is desired, plus 4 if the alarm fix is enabled. High or Low Parameter: **H** = high alarm, **L** = low alarm.

WS Sample Sensor Reading and Alarm Status.

Input: **ws**

Returned: For a Model CYD201, returns:
[sign],[sensor reading],[units],[alarm status] (CR)(LF)
For a Model CYD208, returns:
[current channel],[sign],[sensor reading],[units], [alarm status](CR)(LF)

Remarks: Returns the sample sensor reading and alarm status, where **A** = active and **I** = inactive.

WY Scan Status (**Model CYD208 Only**).

Input: **wy**

Returned: **[scan status],[current channel number],[channel which caused the alarm state], [channel 1 dwell time],[channel 2 dwell time],...[channel 8 dwell time](CR)(LF)**

Remarks: Returns instrument scan status (scanning or holding), channel dwell information, and scan position. Scan Status Parameter: **H** = holding, **S** = scanning. Channel Which Caused the Alarm State Parameter = 1 through 8 or "-" if alarm is inactive. Channel dwell times are in seconds. Sending this command with a Model CYD201 returns **N** to signify no scanner.

This Page Intentionally Left Blank

CHAPTER 5

SERVICE

5.0 GENERAL

This chapter covers Model CYD201/CYD208 maintenance: Model CYD201 Rear Panel Connections (Paragraph 5.1), Model CYD208 Rear Panel Connections (Paragraph 5.2), Error Code Troubleshooting (Paragraph 5.3), General Maintenance (Paragraph 5.4), Fuse Replacement (Paragraph 5.5), Line Voltage Selection (Paragraph 5.6), Calibration (Paragraph 5.7), and Serial Interface Cable and Adapters (Paragraph 5.8).

5.1 MODEL CYD201 REAR PANEL CONNECTIONS

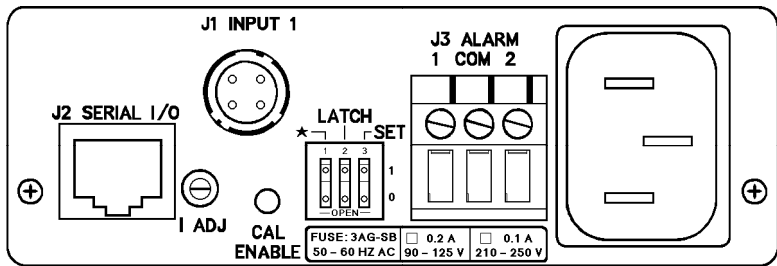

Figure 5-1. Model CYD201 Rear Panel Connections

J1 INPUT 1: Accepts circular 4-pin connector temperature sensor (201-MC).

J2 SERIAL I/O: RJ-11 jack for serial remote communications to a host computer. May require accessories CYD200-J10 (RJ-11 phone cord) and CYD200-D (RJ-11 to DB-25 adapter).

J3 ALARM: Relay responds to alarm setpoints and can trigger another device. Contact 1 is normally open, contact 2 is normally closed.

☆ **Switch:** Not used.

LATCH switch: When on (position 1), turns alarm on but not off (latched) as indicated by temperature change. When off (position 0), turns alarm off or on (unlatched).

SET switch: Used in setting alarm setpoints and recalibration.

CAL ENABLE (Calibration Enable) pushbutton: Used during A/D Converter Calibration. See Paragraph 5.7.2.

I ADJ (Current Adjust) trim potentiometer: Used during Current Source Calibration. See Paragraph 5.7.1.

5.2 MODEL CYD208 REAR PANEL CONNECTIONS

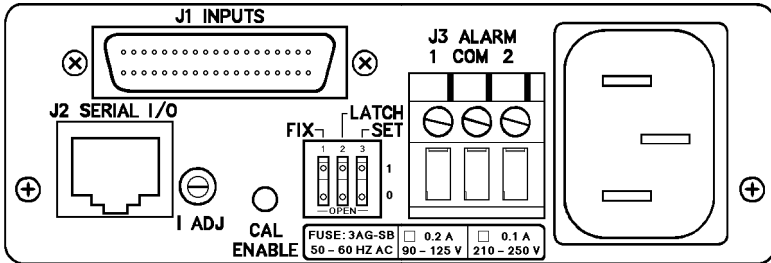

Figure 5-2. Model CYD208 Rear Panel Connections

J1 INPUTS: Accepts 36-pin “D” style connector (208-MC) and multi-sensor adapters. Adapter sits on top of thermometer and accepts up to 8 temperature sensors. Adapter designed for either circular 4-pin (2084) or stripped wire (2081) sensors.

J2 SERIAL I/O: RJ-11 jack for serial remote communications to a host computer. May require accessories CYD200-J10 (RS-232C phone cord) and CYD200-D (RJ-11 to DB-25 adapter).

J3 ALARM: Relay responds to alarm setpoints and can trigger another device. Contact 1 is normally open, contact 2 is normally closed.

FIX switch: Switches alarm functions between monitoring all channels (position 0) or monitoring channel 1 only (position 1).

LATCH switch: When on (position 1), turns alarm on but not off (latched) as indicated by temperature change. When off (position 0), turns alarm off or on (unlatched).

SET switch: Used in setting alarm setpoints and recalibration.

CAL ENABLE (Calibration Enable) pushbutton: Used during A/D Converter Calibration. See Paragraph 5.7.2.

I ADJ (Current Adjust) trim potentiometer: Used during Current Source Calibration. See Paragraph 5.7.1.

5.3 ERROR CODE TROUBLESHOOTING

On power up, the CYD201/CYD208 checks internal memory. If a problem exists, an error message displays on the front panel of the instrument.

Er01 indicates a hardware problem in the instrument memory. This error is not user-correctable.

Er02 indicates a soft error in the instrument memory. To correct this error, use the following procedure.

1. Power up the unit and allow it to display Er02.
2. Close DIP Switch 1 (top of the switch pressed in). Leave the switch closed for at least 5 seconds, then open DIP switch 1 (bottom of the switch pressed in).
3. Verify the Model CYD201/CYD208 display goes through a normal power up sequence and then displays 499.9 K.
4. The input(s) of the Model CYD201/CYD208 must now be recalibrated per in procedure in Paragraph 5.7 before the unit can be used.

OL indicates a voltage input overload. This can be caused by an open sensor or diode sensor wired backwards.

Before calling the factory about a persistent problem, try the procedure below:

WARNING: This procedure erases calibration constants stored in Non-Volatile RAM. If this procedure is used, recalibrate the instrument.

1. With power turned Off, press and hold **CAL ENABLE** on the back panel. While holding **CAL ENABLE**, turn instrument power On.
2. If the Model CYD201/CYD208 displays **Er02**, follow the Calibration procedure in Paragraph 5.7. If **Er01** still displays or if the Model CYD201/CYD208 does not respond, contact OMEGA Service.

5.4 GENERAL MAINTENANCE

Clean the CYD201/CYD208 periodically to remove dust, grease and other contaminants. Clean the front and back panels and case with a soft cloth dampened with a mild detergent and water solution.

NOTE: Do not use aromatic hydrocarbons or chlorinated solvents to clean the Model CYD201/CYD208. They may react with the silk screen printing on the back panel.

5.5 FUSE REPLACEMENT

WARNING: To prevent shock hazard, turn off instrument and disconnect it from AC line power and all test equipment before replacing fuse.

1. Turn POWER switch Off and disconnect power cord from unit. Disconnect all test equipment from unit.
2. Remove all screws from rear panel. Gently pull away rear panel and remove enclosure cover by sliding it to the back.
3. Remove fuse with a fuse puller. The fuse is located behind the transformer as shown in Figure 5.3.
4. Replace with a 0.2 A fuse for 110 V (115 VAC) operation or a 0.1 A fuse for 220 V (230 VAC) operation. Use slow blow fuses.

CAUTION: Replace fuse with the same type and rating as specified by the line voltage selected.

5. Replace enclosure cover, rear panel, and all screws.

5.6 Line Voltage Configuration

The rear-panel, 3-pronged line power connector permits Model CYD201/CYD208 operation at either 110 or 220 VAC. The configuration is indicated on rear panel in the Line Voltage Selection Block. Use the procedure below to change line voltage.

WARNING: To prevent shock hazard, turn off instrument and disconnect it from AC line power and all test equipment before changing line voltage configuration.

1. Turn power switch OFF and disconnect the power cord from the unit. Disconnect all test equipment from unit.
2. Remove all screws from rear panel. Gently pull away rear panel and remove enclosure cover by sliding it to the back.
3. Modify jumper configuration to desired line voltage (see Figure 5-3).
4. Replace fuse to match new voltage requirements.
5. Replace enclosure cover, rear panel and all screws.

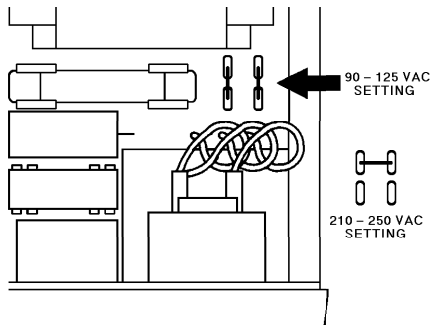

Figure 5-3 Line Voltage Jumper Configuration

5.7 RECALIBRATION

OMEGA calibrates and certifies thermometers to original factory specifications for a reasonable fee. You can recalibrate the thermometer to original specifications, but OMEGA will not warrant these calibrations.

Recalibration requires a digital voltmeter (DVM) with 4½ digit resolution or better; and 25 kΩ and 125 kΩ precision resistors with ±0.01% tolerance or better.

Recalibration involves current source and analog/digital (A/D) converter calibration. A/D calibration erases all SoftCal™ compensations; perform it after current source calibration, not before.

5.7.1 Current Source Calibration

1. Allow 30 minute warm-up to achieve rated specifications.
2. Configure 125 kΩ resistor as shown in Figure 5-4. Set Model CYD208 to channel 1.
3. Connect DVM voltage leads across the resistor and adjust the I ADJ trimpot (located on rear panel) until DVM displays a voltage of 1.2500 volts ±100 microvolts.
4. Remove DVM and resistor.

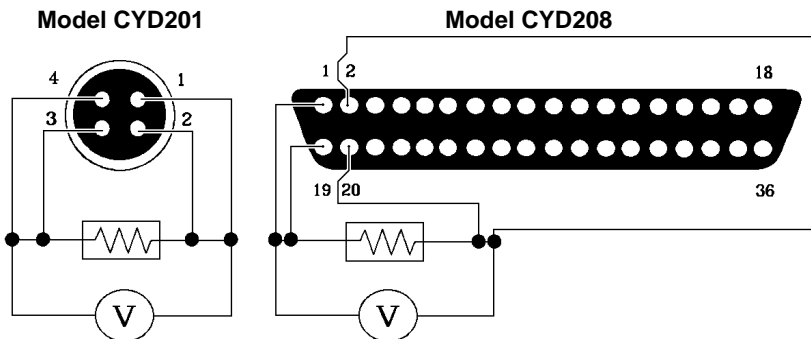

NOTE: Do not use a voltmeter for A/D Converter Calibration.

Figure 5-4. Calibration Connections

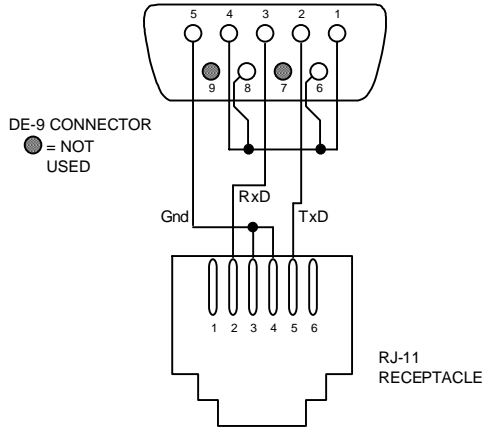

Figure 5-7. Model CYD200-B RJ-11 to DE-9 Adapter Wiring Details

This Page Intentionally Left Blank

CHAPTER 6

OPTIONS AND ACCESSORIES

6.0 GENERAL

This chapter lists options, accessories, sensors, wires, and special equipment available for the Model CYD201/CYD208.

6.1 ACCESSORIES

MODEL	DESCRIPTION OF ACCESSORY
201-MC	4-pin Mating Connector for Model CYD201 and Model 2084.
208-MC	36-pin "D" Style Connector for Model CYD208.
CYD200-J10	RJ-11 to RJ-11 Phone Cord, 10 feet (3 meters). See Figure 6-1.
CYD200-D	RJ-11 to DB-25 Adapter. Connects RJ-11 to RS-232C Serial Port on rear of computer. See Figure 6-1.
CYD200-B	RJ-11 to DE-9 Adapter. Connects RJ-11 to RS-232C Serial Port on rear of computer. See Figure 6-1.
2010	Model CYD201 calibration connector.
2080	Model CYD208 calibration connector.
2081	Screw Terminal Adapter. Connects Model CYD208 to multiple sensor/probe assemblies with stripped ends and non-permanent wiring. Provision for attachment to top of thermometer. Fitted with "D" type mating connector.
2082-1	Stainless steel Sensor Probe with 6-foot (1.83 m) cable with 4 stripped ends. 4-inch (10 cm) long by 1/8 inch (3.2 mm) diameter probe.
2082-2	Stainless steel Sensor Probe with 6-foot (1.83 m) cable with 4-pin 201-MC mating connector. 4-inch (10 cm) long by 1/8 inch (3.2 mm) diameter probe.
2082-3	Stainless steel Sensor Probe with 12-foot (3.7 m) cable with 4 stripped ends. 6-inch (15 cm) long by 1/8 inch (3.2 mm) diameter probe.
2082-4	Stainless steel Sensor Probe with 12-foot (3.7 m) cable with 4-pin 201-MC mating connector. 6-inch (15 cm) long by 1/8 inch (3.2 mm) diameter probe.

ACCESSORIES (continued)

MODEL	DESCRIPTION OF ACCESSORY
2083-1	Sensor Probe. 12-foot (3.7 m) cable with CY-7-SD-13 sensor in CY mounting adapter, stripped ends. Temperature limit: 325 K (52 °C). Diode sensor epoxied (Stycast) into center of 0.564 inch (1.43 cm) diameter by 0.20 inch (5 mm) thick copper disk. 30 AWG copper leads anchored to disk. Mass (excluding leads): 4.3 grams.
2083-2	Sensor Probe. 12-foot (3.7 m) cable with CY-7-SD-13 sensor in CY mounting adapter, with 4-pin CYD201-MC mating connector. Temperature limit: 325 K (52 °C). Diode sensor epoxied (Stycast) into center of 0.564 inch (1.43 cm) diameter by 0.20 inch (5 mm) thick copper disk. 30 AWG copper leads anchored to disk. Mass (excluding leads): 4.3 grams.
2084	Multi-Connector Adapter. Required with Model CYD208 when using multiple probe/cable assemblies and Model 201-MC mating connectors.
CYD208 -DIN	Mounting Adapter for Rack Installation. For installation in a ¼ panel EIA rack space. See Figure 2-3.

6.2 MODEL CYD201/CYD208 WIRES

LSCI P/N	DESCRIPTION OF CABLE
9001-005	Quad-Twist™ Cryogenic Wire. Two twisted pairs, phosphor-bronze wire, 36 AWG, 0.127 mm (0.005 inch) diameter.
9001-006	Duo-Twist™ Cryogenic Wire. Single twisted pair, phosphor-bronze wire, 36 AWG, 0.127 mm (0.005 inch) diameter.
9001-007	Quad-Lead™ Cryogenic Wire. Phosphor-bronze wire, flat, 32 AWG, 0.203 mm (0.008 inch) diameter.
9001-008	Quad-Lead™ Cryogenic Wire. Phosphor-bronze wire, flat, 32 AWG, 0.127 mm (0.005 inch) diameter.
—	Any quality dual shield twisted pair wire for dewar to Model CYD201/CYD208 connector.

6.3 MODEL CYD201/CYD208 SENSORS

SENSOR NO.	DESCRIPTION OF SENSOR
Series DT-420	The smallest silicon diode Temperature Sensor available. Installs on flat surfaces. Same silicon chip as Series CY-7 and DT-471.
Series DT-450	Silicon Diode Miniature Temperature Sensor. Same silicon chip as CY-7 designed to install in recesses as small as 1.6 mm dia. by 3.2 mm deep.
Series CY-7	Silicon Diode Temperature Sensor. Repeatable, interchangeable, accurate, wide range, customized for cryogenics.
Series DT-471	An economical version of the CY-7 for applications where temperature measurements below 10 K are not required.

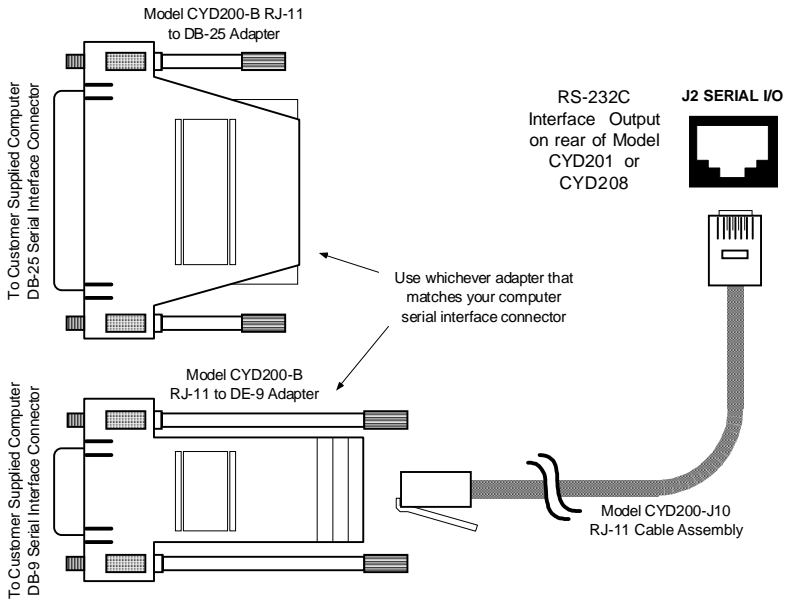

Figure 6-1. Serial Interface Adapters

This Page Intentionally Left Blank

APPENDIX A

CURVE TABLES

A1.0 GENERAL

The following curve tables apply to the Model CYD201/CYD208: Curve 0 - DT-500DI-8B (Table A-1), Curve 1 - DT-500DI-8A (Table A-2), Curve 2 - DT-500DRC-D (Table A-3), Curve 3 - DT-500DRC-E1 (Table A-4), Curve 4 - CTI Curve C (Table A-5), Curve 5 - DT-500DI-8C (Table A-6), and Curve 6 - CY-7 Curve 10 (Table A-7).

Table A-1. Curve 0: DT-500DI-8B Voltage-Temp. Characteristics

BP #	Temp. (K)	PROM Voltage	BP #	Temp. (K)	PROM Voltage	BP #	Temp. (K)	PROM Voltage	
29	4.0	2.41773	19	29.0	1.11353	7	170.0	0.73733	
	4.2	2.40475		18	30.0		1.10729	175.0	0.72353
	4.4	2.39217		17	32.0		1.09810	180.0	0.70936
	4.6	2.37946		16	34.0		1.09125	185.0	0.69532
	4.8	2.36668		15	36.0		1.08547	190.0	0.68125
	5.0	2.35378			38.0		1.08038	195.0	0.66713
	5.5	2.32126		14	40.0		1.07549	200.0	0.65302
	6.0	2.28869			45.0		1.06400	205.0	0.63889
	6.5	2.25643		13	50.0		1.05273	210.0	0.62475
	7.0	2.22480			55.0		1.04123	215.0	0.61066
28	7.5	2.19395	12	60.0	1.02954	6	220.0	0.59646	
	8.0	2.16053		65.0	1.01748	225.0	0.58262		
	8.5	2.13552	11	70.0	1.00528	230.0	0.56877		
	9.0	2.10809		75.0	0.99263	235.0	0.55504		
	9.5	2.08197		77.4	0.98666	5	240.0	0.54136	
	10.0	2.05687		80.0	0.97988	245.0	0.52801		
	11.0	2.00852	10	85.0	0.96711	250.0	0.51469		
	12.0	1.96003		90.0	0.95397	4	255.0	0.50155	
	13.0	1.90579		95.0	0.94086	260.0	0.48815		
	14.0	1.85614		100.0	0.92767	265.0	0.47486		
27	15.0	1.80479		105.0	0.91443	270.0	0.46148		
	16.0	1.74703	9	110.0	0.90124	275.0	0.44800		
	17.0	1.67479		115.0	0.88776	3	280.0	0.43451	
	18.0	1.60665		120.0	0.87434	285.0	0.42064		
	19.0	1.53675		125.0	0.86087	290.0	0.40675		
	20.0	1.46370		130.0	0.84735	295.0	0.39274		
	21.0	1.38832		135.0	0.83377	2	300.0	0.37875	
	22.0	1.31868	8	140.0	0.82032	305.0	0.36436		
	23.0	1.26476		145.0	0.80647	310.0	0.35002		
	24.0	1.21712		150.0	0.79274	315.0	0.33559		
25	25.0	1.17857		155.0	0.77896	320.0	0.32109		
	26.0	1.15106		160.0	0.76513	325.0	0.30656		
	27.0	1.13317		165.0	0.75125	1	330.0	0.29222	
	28.0	1.12169							

Table A-2. Curve 1: DT-500DI-8A Voltage-Temp. Characteristics

BP #	Temp. (K)	PROM Voltage	BP #	Temp. (K)	PROM Voltage	BP #	Temp. (K)	PROM Voltage
30	4.0	2.46386	17	29.0	1.11741	7	170.0	0.72739
	4.2	2.44821		30.0	1.11007		175.0	0.71308
	4.4	2.43188		32.0	1.09942		180.0	0.69891
	4.6	2.41500		34.0	1.09178		185.0	0.68469
29	4.8	2.39781	13	36.0	1.08559	6	190.0	0.67043
	5.0	2.37578		38.0	1.07992		195.0	0.65615
	5.5	2.33823		40.0	1.07502		200.0	0.64185
	6.0	2.29906		45.0	1.06307		205.0	0.62754
28	6.5	2.26440	11	50.0	1.05136	5	210.0	0.61333
	7.0	2.23248		55.0	1.03951		215.0	0.59901
	7.5	2.20480		60.0	1.02744		220.0	0.58502
	8.0	2.17716		65.0	1.01475		225.0	0.57099
27	8.5	2.14994	10	70.0	1.00193	4	230.0	0.55715
	9.0	2.12245		75.0	0.98892		235.0	0.54327
	9.5	2.10065		77.4	0.98264		240.0	0.52983
	10.0	2.07844		80.0	0.97557		245.0	0.51639
26	11.0	2.03712	9	85.0	0.96216	3	250.0	0.50302
	12.0	1.99736		90.0	0.94877		255.0	0.48965
	13.0	1.95641		95.0	0.93535		260.0	0.47625
	14.0	1.91202		100.0	0.92166		265.0	0.46292
25	15.0	1.85236	8	105.0	0.90798	2	270.0	0.44925
	16.0	1.79177		110.0	0.89426		275.0	0.43559
	17.0	1.73193		115.0	0.88052		280.0	0.42178
	18.0	1.66870		120.0	0.86676		285.0	0.40797
24	19.0	1.59215	7	125.0	0.85298	1	290.0	0.39375
	20.0	1.51169		130.0	0.83936		295.0	0.37951
	21.0	1.43234		135.0	0.82531		300.0	0.36515
	22.0	1.34993		140.0	0.81142		305.0	0.35078
23	23.0	1.28434		145.0	0.79749		310.0	0.33599
22	24.0	1.23212		150.0	0.78351		315.0	0.32121
21	25.0	1.18995		155.0	0.76950		320.0	0.30643
20	26.0	1.16027		160.0	0.75544		325.0	0.29159
19	27.0	1.14015		165.0	0.74135		330.0	0.27665
18	28.0	1.12689						

Table A-3. Curve 2: DT-500DRC-D Voltage-Temp. Characteristics

BP #	Temp. (K)	PROM Voltage	BP #	Temp. (K)	PROM Voltage	BP #	Temp. (K)	PROM Voltage
30	1.4	2.5984	24	21.0	1.3505	8	180.0	0.70757
	1.5	2.5958		22.0	1.3006		185.0	0.69344
	1.6	2.5932	23	23.0	1.2507		190.0	0.67931
	1.7	2.5906		24.0	1.2114		195.0	0.66518
	1.8	2.5880	22	25.0	1.1720		200.0	0.65105
	1.9	2.5854	21	26.0	1.1486		205.0	0.63693
	2.0	2.5828	20	27.0	1.1308		210.0	0.62280
	2.2	2.5735	19	28.0	1.1190		215.0	0.60867
	2.4	2.5643	18	29.0	1.1116		220.0	0.59455
	2.6	2.5551	17	30.0	1.1058		225.0	0.58080
29	2.8	2.5458	16	32.0	1.0970	230.0	0.56707	
	3.0	2.5366	15	34.0	1.0902	235.0	0.55334	
	3.2	2.5226		36.0	1.0850	7	240.0	0.53960
	3.4	2.5086		38.0	1.0798	245.0	0.52649	
	3.6	2.4946	14	40.0	1.0746	250.0	0.51337	
	3.8	2.4807		45.0	1.0633	255.0	0.50026	
	4.0	2.4667		50.0	1.0520	260.0	0.48714	
	4.2	2.4527	13	55.0	1.0407	6	265.0	0.47403
	4.4	2.4387		60.0	1.0287	270.0	0.46057	
	4.6	2.4247		65.0	1.0166	275.0	0.44711	
28	4.8	2.4108	12	70.0	1.0046	280.0	0.43365	
	5.0	2.3968		75.0	0.99172	5	285.0	0.42019
	5.5	2.3618		80.0	0.97890	290.0	0.40613	
	6.0	2.3269		85.0	0.96609	295.0	0.39208	
	6.5	2.2919	11	90.0	0.95327	300.0	0.37802	
	7.0	2.2570		95.0	0.93987	4	305.0	0.36397
	7.5	2.2220		100.0	0.92647	310.0	0.34940	
	8.0	2.1871		105.0	0.91307	315.0	0.33482	
	8.5	2.1521		110.0	0.89966	320.0	0.32025	
	9.0	2.1172		115.0	0.88626	325.0	0.30568	
27	9.5	2.0909		120.0	0.87286	330.0	0.29111	
	10.0	2.0646		125.0	0.85946	335.0	0.27654	
	11.5	2.0119	10	130.0	0.84606	340.0	0.26197	
	12.0	1.9592		135.0	0.83228	3	345.0	0.24739
	13.0	1.9066		140.0	0.81850	350.0	0.23325	
	14.0	1.8338		145.0	0.80472	355.0	0.21911	
	26	15.0	1.7610		150.0	0.79094	360.0	0.20497
		16.0	1.6984		155.0	0.77716	2	365.0
	25	17.0	1.6359		160.0	0.76338	370.0	0.17774
		18.0	1.5646		165.0	0.74961	375.0	0.16464
19.0		1.4932	9	170.0	0.73582	1	380.0	0.15155
20.0		1.4219		175.0	0.72170			

Table A-4. Curve 3: DT-500DRC-E1 Voltage-Temp. Characteristics

BP #	Temp. (K)	PROM Voltage	BP #	Temp. (K)	PROM Voltage	BP #	Temp. (K)	PROM Voltage	
30	1.4	2.6591		18.0	1.6527		145.0	0.8035	
	1.5	2.6567		19.0	1.5724		150.0	0.7896	
	1.6	2.6542		20.0	1.4922		155.0	0.7758	
	1.7	2.6518		21.0	1.4120		160.0	0.7620	
	1.8	2.6494		22.0	1.3317		165.0	0.7482	
29	1.9	2.6470	21	23.0	1.2837	7	170.0	0.7344	
	2.0	2.6446		24.0	1.2357		175.0	0.7202	
	2.2	2.6355		25.0	1.1877		180.0	0.7060	
	2.4	2.6265		20	26.0		1.1559	185.0	0.6918
	2.6	2.6175		19	27.0		1.1365	190.0	0.6777
28	2.8	2.6084	18	28.0	1.1239		195.0	0.6635	
	3.0	2.5994		17	29.0		1.1150	200.0	0.6493
	3.2	2.5868		16	30.0		1.1080	205.0	0.6351
	3.4	2.5742		15	32.0		1.0981	210.0	0.6210
	3.6	2.5616		14	34.0		1.0909	215.0	0.6068
27	3.8	2.5490	13	36.0	1.0848	6	220.0	0.5926	
	4.0	2.5364		38.0	1.0797		225.0	0.5789	
	4.2	2.5221		12	40.0		1.0746	230.0	0.5651
	4.4	2.5077			45.0		1.0630	235.0	0.5514
	4.6	2.4934			50.0		1.0515	240.0	0.5377
4.8	2.4791	55.0	1.0399		245.0	0.5246			
5.0	2.4648	11	60.0		1.0284	250.0	0.5115		
5.5	2.4290		65.0	1.0159	255.0	0.4984			
6.0	2.3932		70.0	1.0035	260.0	0.4853			
6.5	2.3574		75.0	0.9911	4	265.0	0.4722		
7.0	2.3216		77.35	0.9849		270.0	0.4588		
7.5	2.2858	80.0	0.9780	275.0		0.4454			
8.0	2.2500	85.0	0.9649	280.0		0.4320			
8.5	2.2142	90.0	0.9518	3		285.0	0.4186		
26	9.0	2.1784	95.0		0.9388	290.0	0.4045		
	9.5	2.1516	9		100.0	0.9257	295.0	0.3904	
	10.0	2.1247			105.0	0.9122	300.0	0.3763	
	11.0	2.0708			110.0	0.8988	2	305.0	0.3622
	12.0	2.0170		115.0	0.8853	310.0		0.3476	
25	13.0	1.9632		120.0	0.8718	315.0		0.3330	
	14.0	1.9011	125.0	0.8584	320.0	0.3184			
	15.0	1.8390	8	130.0	0.8449	325.0		0.3038	
	16.0	1.7769		135.0	0.8311	1	330.0	0.2893	
	17.0	1.7148		140.0	0.8173				

Table A-5. Curve 4: CTI Diode Voltage-Temp. Characteristics

BP #	Temp. (K)	PROM Voltage	BP #	Temp. (K)	PROM Voltage	BP #	Temp. (K)	PROM Voltage
29	10.0	1.4000		55.0	1.0235		190.0	0.6545
28	11.0	1.3850	21	60.0	1.0100	8	195.0	0.6408
27	12.0	1.3656	20	65.0	0.9958		200.0	0.6270
	13.0	1.3400		70.0	0.9822		205.0	0.6133
26	14.0	1.3161		75.0	0.9690		210.0	0.5995
	15.0	1.2750	19	77.4	0.9626		215.0	0.5858
	16.0	1.2350		80.0	0.9560		220.0	0.5720
	17.0	1.1910	18	85.0	0.9440		225.0	0.5583
25	18.0	1.1500	17	90.0	0.9314		230.0	0.5445
24	19.0	1.1290	16	95.0	0.9184		235.0	0.5308
23	20.0	1.1162	15	100.0	0.9049		240.0	0.5170
	21.0	1.1135		105.0	0.8907		245.0	0.5032
	22.0	1.1109	14	110.0	0.8769	7	250.0	0.4896
	23.0	1.1084	13	115.0	0.8625		255.0	0.4757
	24.0	1.1058		120.0	0.8500		260.0	0.4620
	25.0	1.1033	12	125.0	0.8376		265.0	0.4481
	26.0	1.1007	11	130.0	0.8245	6	270.0	0.4341
	27.0	1.0981		135.0	0.8109		275.0	0.4197
	28.0	1.0955	10	140.0	0.7971	5	280.0	0.4050
	29.0	1.0929		145.0	0.7828	4	285.0	0.3911
	30.0	1.0903		150.0	0.7685		290.0	0.3775
	32.0	1.0851		155.0	0.7543	3	295.0	0.3640
	34.0	1.0799		160.0	0.7400		300.0	0.3510
22	36.0	1.0747	9	165.0	0.7255	2	305.0	0.3382
	38.0	1.0693		170.0	0.7114		310.0	0.3243
	40.0	1.0640		175.0	0.6972		315.0	0.3106
	45.0	1.0505		180.0	0.6830	1	320.0	0.2968
	50.0	1.0370		185.0	0.6690			

Table A-6. Curve 5: DT-500DI-8C Voltage-Temp. Characteristics

BP #	Temp. (K)	PROM Voltage	BP #	Temp. (K)	PROM Voltage	BP #	Temp. (K)	PROM Voltage	
29	4.0	2.6187	23	24.0	1.2317	7	135.0	0.8377	
	4.2	2.6074		22	25.0		1.1900	140.0	0.8243
	4.4	2.5956		21	26.0		1.1602	145.0	0.8108
	4.6	2.5834		20	27.0		1.1402	150.0	0.7974
	4.8	2.5709		19	28.0		1.1269	155.0	0.7837
28	5.0	2.5580	18	29.0	1.1173	6	160.0	0.7701	
	5.2	2.5484		17	30.0		1.1100	165.0	0.7564
	5.4	2.5312		16	31.0		1.1039	170.0	0.7427
	5.6	2.5173			32.0		1.0991	175.0	0.7289
	5.8	2.5033		15	33.0		1.0949	180.0	0.7152
27	6.0	2.4890	14	34.0	1.0913	5	185.0	0.7013	
	6.5	2.4524		14	35.0		1.0879	190.0	0.6874
	7.0	2.4151			36.0		1.0850	195.0	0.6734
	7.5	2.3773			37.0		1.0822	200.0	0.6595
	8.0	2.3394		13	38.0		1.0795	205.0	0.6455
26	8.5	2.2976	12	39.0	1.0770	4	210.0	0.6315	
	9.0	2.2643			40.0		1.0746	215.0	0.6176
	9.5	2.2277			42.0		1.0697	220.0	0.6036
	10.0	2.1919		11	44.0		1.0649	225.0	0.5898
	10.5	2.1566			46.0		1.0603	230.0	0.5761
25	11.0	2.1221	10	48.0	1.0558	3	235.0	0.5625	
	11.5	2.0881			50.0		1.0512	240.0	0.5490
	12.0	2.0545			52.0		1.0467	245.0	0.5358
	12.5	2.0211			54.0		1.0421	250.0	0.5226
	13.0	1.9875		9	56.0		1.0376	255.0	0.4096
24	13.5	1.9537	8	58.0	1.0330	2	260.0	0.4966	
	14.0	1.9193			60.0		1.0285	265.0	0.4836
	14.5	1.8843			65.0		1.0168	270.0	0.4705
	15.0	1.8480			70.0		1.0049	275.0	0.4574
	15.5	1.8110		7	75.0		0.9930	280.0	0.4442
23	16.0	1.7748	6	77.4	0.9870	1	285.0	0.4307	
	16.5	1.7441			80.0		0.9805	290.0	0.4171
	17.0	1.7047			85.0		0.9680	295.0	0.4035
	17.5	1.6702			90.0		0.9553	300.0	0.3898
	18.0	1.6361		5	95.0		0.9427	305.0	0.3758
22	18.5	1.6022	4	100.0	0.9297	0	310.0	0.3618	
	19.0	1.5676			105.0		0.9168	315.0	0.3477
	19.5	1.5316			110.0		0.9038	320.0	0.3336
	20.0	1.4950			115.0		0.8907	325.0	0.3194
	21.0	1.4218		3	120.0		0.8777	330.0	0.3054
21	22.0	1.3461	2	125.0	0.8643	0			
	23.0	1.2840		1	130.0		0.8510		

Table A-7. Curve 6: CY-7 Voltage-Temp. Characteristics

BP #	Temp. (K)	PROM Voltage	BP #	Temp. (K)	PROM Voltage	BP #	Temp. (K)	PROM Voltage	
29	1.4	1.69808	25	12.0	1.36687	13	70.0	1.03425	
	1.5	1.69674		12.5	1.35647		75.0	1.02482	
	1.6	1.69521		13.0	1.34530		77.4	1.02044	
28	1.7	1.69355	24	13.5	1.33453	12	80.0	1.01525	
	1.8	1.69177		14.0	1.32412		85.0	1.00552	
	1.9	1.68987		14.5	1.31403		90.0	0.99565	
	2.0	1.68812		15.0	1.30422		95.0	0.98574	
	2.1	1.68574		15.5	1.29340		100.0	0.97550	
	2.2	1.68352		16.0	1.28527		105.0	0.96524	
	2.3	1.68121		16.5	1.27607		110.0	0.95487	
	2.4	1.67880		17.0	1.26702		115.0	0.94455	
	2.5	1.67632		17.5	1.25810		120.0	0.93383	
	2.6	1.67376		18.0	1.24928		125.0	0.92317	
	2.7	1.67114		18.5	1.24053		130.0	0.91243	
27	2.8	1.66845	23	19.0	1.23184	11	135.0	0.90161	
	2.9	1.66571		19.5	1.22314		140.0	0.89082	
	3.0	1.66292		20.0	1.21555		145.0	0.87976	
	3.1	1.66009		21.0	1.19645		150.0	0.86873	
	3.2	1.65721		22.0	1.17705		155.0	0.85764	
	3.3	1.65430		23.0	1.15558		160.0	0.84650	
	3.4	1.65134		22	24.0		1.13598	165.0	0.83541
	3.5	1.64833		21	25.0		1.12463	170.0	0.82404
	3.6	1.64529		20	26.0		1.11896	175.0	0.81274
	3.7	1.64219		19	27.0		1.11517	180.0	0.80138
26	3.8	1.64112	17	18	28.0	1.11202	185.0	0.78999	
	3.9	1.63587		19	29.0	1.10945	190.0	0.77855	
	4.0	1.63263		20	30.0	1.10702	195.0	0.76717	
	4.2	1.62602		21	31.0	1.10465	200.0	0.75554	
	4.4	1.61920		22	32.0	1.10263	205.0	0.74398	
	4.6	1.61220		23	33.0	1.10060	210.0	0.73238	
	4.8	1.60506		24	34.0	1.09864	215.0	0.72075	
	5.0	1.59782		25	35.0	1.09675	220.0	0.70908	
	5.2	1.59047		16	36.0	1.09477	225.0	0.69737	
	5.4	1.58303		15	37.0	1.09309	230.0	0.68580	
26	5.6	1.57551	14	38.0	1.09131	7	235.0	0.67387	
	5.8	1.56792		39.0	1.08955		240.0	0.66208	
	6.0	1.56027		40.0	1.08781		245.0	0.65026	
	6.5	1.54097		42.0	1.08436		250.0	0.63841	
	7.0	1.52166		44.0	1.08105		255.0	0.62654	
	7.5	1.50272		46.0	1.07748		260.0	0.61465	
	8.0	1.48443		48.0	1.07402		265.0	0.60273	
	8.5	1.46700		50.0	1.07053		270.0	0.59080	
	9.0	1.44850		52.0	1.06700		275.0	0.57886	
	9.5	1.43488		54.0	1.06346		280.0	0.56707	
26	10.0	1.42013	14	56.0	1.05988	6	285.0	0.55492	
	10.5	1.40615		58.0	1.05629		290.0	0.54294	
	11.0	1.39287		60.0	1.05277		295.0	0.53093	
	11.5	1.38021		65.0	1.04353		300.0	0.51892	

Table A-7. Curve 6: CY-7 Voltage-Temp. Characteristics (Continued)

BP #	Temp. (K)	PROM Voltage	BP #	Temp. (K)	PROM Voltage	BP #	Temp. (K)	PROM Voltage
5	305.0	0.50689	4	365.0	0.36110	3	425.0	0.21212
	310.0	0.49484		370.0	0.34881		430.0	0.19961
	315.0	0.48278		375.0	0.33650		435.0	0.18696
	320.0	0.47069		380.0	0.32416		440.0	0.17464
	325.0	0.45858		385.0	0.31180		445.0	0.16221
	330.0	0.44647		390.0	0.29958	450.0	0.14985	
	335.0	0.43435		395.0	0.28700	455.0	0.13759	
	340.0	0.42238		400.0	0.27456	2	460.0	0.12536
	345.0	0.41003		405.0	0.26211	465.0	0.11356	
	350.0	0.39783		410.0	0.24963	470.0	0.10191	
355.0	0.38561	415.0	0.23714	1	475.0	0.09032		
360.0	0.37337	420.0	0.22463					

80 **NOTES** 88

80 NOTES 88

OMEGA...YOUR SOURCE FOR PROCESS MEASUREMENT AND CONTROL

TEMPERATURE

- Thermocouple, RTD & Thermistor Probes & Assemblies
- Connector Systems and Panels
- Wire: Thermocouple, RTD, and Thermistor
- Calibrators and Ice Point References
- Recorders, Controllers, and Process Monitors
- Data Acquisition Modules and Data Loggers
- Computer Sensor Interface

PRESSURE/STRAIN

- Transducers
- Strain Gauges
- Load Cells
- Pressure Gauges
- Instrumentation

FLOW

- Rotameters
- Flowmeter Systems
- Air Velocity Indicators
- Turbine/Paddlewheel Systems
- Vortex Meters and Flow Computers

pH

- Electrodes
- Benchtop/Laboratory Meters
- Controllers
- Calibrators/Simulators
- Transmitters



An OMEGA Technologies Company

OMEGA...YOUR SOURCE FOR PROCESS MEASUREMENT AND CONTROL

These are the FREE complete reference books you will want to keep within reach at all times. Send for your LATEST COPY now!



One Omega Drive, Box 4047
Stamford, CT 06907-0047
Telex: 996404
FAX: (203) 359-7700
Phone: (203) 359-1660

Ω OMEGA
ENGINEERING, INC.
An OMEGA Technologies Company