



User's Guide



<http://www.omega.com>
e-mail: info@omega.com

Only model 871A has
CE certification



871A and 872A Digital Thermometers

omega.com™

Ω OMEGA®

OMEGAnetSM On-Line Service
<http://www.omega.com>

Internet e-mail
info@omega.com

Servicing North America:

USA:
ISO 9001 Certified

One Omega Drive, Box 4047
Stamford, CT 06907-0047
Tel: (203) 359-1660
e-mail: info@omega.com

FAX: (203) 359-7700

Canada:

976 Bergar
Laval (Quebec) H7L 5A1
Tel: (514) 856-6928
e-mail: canada@omega.com

FAX: (514) 856-6886

For immediate technical or application assistance:

USA and Canada:

Sales Service: 1-800-826-6342 / 1-800-TC-OMEGASM
Customer Service: 1-800-622-2378 / 1-800-622-BESTSM
Engineering Service: 1-800-872-9436 / 1-800-USA-WHENSM
TELEX: 996404 EASYLINK: 62968934 CABLE: OMEGA

**Mexico and
Latin America:**

Tel: (95) 800-TC-OMEGASM
En Español: (203) 359-1660 ext: 2203

FAX: (95) 203-359-7807
e-mail: espanol@omega.com

Servicing Europe:

Benelux:

Postbus 8034, 1180 LA Amstelveen, The Netherlands
Tel: (31) 20 6418405
Toll Free in Benelux: 06 0993344
e-mail: nl@omega.com

FAX: (31) 20 6434643

Czech Republic:

Ostravska 767, 733 01 Karvina
Tel: 42 (69) 6311899
e-mail: czech@omega.com

FAX: 42 (69) 6311114

France:

9, rue Denis Papin, 78190 Trappes
Tel: (33) 130-621-400
Toll Free in France: 0800-4-06342
e-mail: france@omega.com

FAX: (33) 130-699-120

Germany/Austria:

Daimlerstrasse 26, D-75392 Deckenpfronn, Germany
Tel: 49 (07056) 3017
Toll Free in Germany: 0130 11 21 66
e-mail: germany@omega.com

FAX: 49 (07056) 8540

United Kingdom:

ISO 9002 Certified

25 Swannington Road,
Broughton Astley, Leicestershire,
LE9 6TU, England
Tel: 44 (1455) 285520
FAX: 44 (1455) 283912

P.O. Box 7, Omega Drive,
Irlam, Manchester,
M44 5EX, England
Tel: 44 (161) 777-6611
FAX: 44 (161) 777-6622

Toll Free in England: 0800-488-488
e-mail: uk@omega.com

It is the policy of OMEGA to comply with all worldwide safety and EMC/EMI regulations that apply. OMEGA is constantly pursuing certification of its products to the European New Approach Directives. OMEGA will add the CE mark to every appropriate device upon certification.

The information contained in this document is believed to be correct but OMEGA Engineering, Inc. accepts no liability for any errors it contains, and reserves the right to alter specifications without notice.

WARNING: These products are not designed for use in, and should not be used for, patient connected applications.

TABLE OF CONTENTS
MODEL 871A AND MODEL 872A
DIGITAL THERMOMETERS

SECTION	PAGE
SECTION 1 INTRODUCTION	1
1.1 General Description	1
1.2 Features	1
2.1 Accessory Items.....	1
SECTION 2 INSTALLATION	2
2.1 Unpacking.....	2
2.2 Battery Installation	2
SECTION 3 OPERATION	3
3.1 Controls and Indicators.....	3
3.2 Operating Procedure.....	5
SECTION 4 SERVICE INFORMATION	5
4.1 Verification Check	5
4.1.1 Functionality Check	5
4.1.2 Accuracy Check.....	6
4.2 Calibration for Model 871A	6
4.2.1 Equipment Needed	6
4.2.2 Environmental Conditions	6
4.2.3 Setup.....	7
4.2.4 Calibration Procedure	7
4.3 Calibration for Model 872A	8
4.3.1 Equipment Needed	8
4.3.2 Environmental Conditions	8
4.3.3 Setup.....	8
4.3.4 Calibration Procedure	9
4.4 Disassembly for Model 871A and Model 872A.....	10
4.5 Troubleshooting Guide	11
4.5.1 DC Voltage checks Model 871A	12
4.5.2 DC Voltage Checks Model 872A	12
4.5.3 Waveform Checks Model 871A	13
4.5.4 Waveform Checks Model 872A	13
SECTION 5 SPECIFICATIONS FOR MODEL 871A AND MODEL 872A	13
5.1 Parts List	16

SECTION 1 INTRODUCTION

1.1 GENERAL DESCRIPTION

The OMEGA® Model 871A and Model 872A Digital Thermometers are ultrasensitive hand held instruments. Low power LSI devices combined with a large 0.6" (15 mm) LCD, deliver reliability, extended battery life, and an extremely readable readout. One nine volt battery will deliver 100 hours of continuous operation.

The 871A and 872A are operationally identical except for minor differences related to each model's thermocouple input: Model 871A is designed for use with type K (Chromel-Alumel) thermocouples; Model 872A is designed for use with type J (Iron-Constantan) thermocouples.

Cold junction electronic circuitry in the Model 871A and Model 872A automatically compensates for ambient temperature changes. A special integrating A/D converter corrects for thermocouple non-linearity during each digitization cycle. The resulting conformity to the standard thermocouple voltage table is within 1°C over the entire measurement span of the instrument.

Although the 871A and 872A are ideal for temperature measurement in the field, they also function well as bench instruments when equipped with the optional tilt stand. The Model 871A and Model 872A provide dual inputs, selectable scales (°F/°C), 1.0° and 0.1° resolution, and an analog output. The versatile dual input configuration permits two point temperature measurement such as those required in process monitoring. The analog output allows interfacing with chart recorders or data acquisition system's functioning as an electronic ice-point reference.

1.2 FEATURES

- Wide temperature range
- Selectable scales (°F/°C)
- 0.1° and 1.0° resolution
- 0.25% accuracy
- Dual thermocouple inputs
- Analog output
- Heavy duty construction

1.2.1 ACCESSORY ITEMS

SC-GG-[*]-30-36-SMP-M	Thermocouple sensor (supplied with unit) if purchased separately.
KS-871	Tilt stand
SC-800	Soft carrying case
880-A2	Deluxe carrying case
U9VL	9 V lithium battery
SMP-[*]-M	Subminiature thermocouple connector, male
SMP-[*]-F	Subminiature thermocouple connector, female
OS-201-1	2 oz. jar of high thermal conductivity paste for fast surface measurements

*Insert thermocouple type: J for Model 872, K for Model 871

SECTION 2 INSTALLATION

2.1 UNPACKING

Remove the Packing List and verify that all equipment has been received. If there are any questions about the shipment, please call OMEGA Customer Service Department at 800-622-2378 or (203) 359-1660.

The following items are included:

Quantity	Description
1	871 or 872 Digital Thermometer
2	Beaded Wire Thermocouples
1	TAS Transition Adapter
1	9 Volt Alkaline Battery
1	Operator's Manual

Upon receipt of shipment, inspect the container and equipment for any sign of damage. Take particular note of any evidence of rough handling in transit. Immediately report any damage to the shipping agent.

NOTE

The carrier will not honor any claims unless all shipping material is saved for their examination. After examining and removing contents, save packing material and carton in the event reshipment is necessary.

2.2 BATTERY INSTALLATION

WARNING

Turn the model 871/872A off and disconnect the input probes before replacing the battery. Put the cover back into place on the battery compartment before resuming use of the instrument.

A 9 V battery is supplied with the instrument but not installed. To install the battery, remove the cover from the battery compartment by sliding it off in the direction of the arrow located on the battery cover. The battery connector snaps on and off the terminals of the battery. Improper installation of the battery will cause the connecting wires to be severed by excess strain. Proper installation requires that the battery be positioned in such a manner (see Figure 2-1) that the leads protruding from the boot of the battery connector face toward the outside of the battery compartment. If the instrument is going to be stored for a long period of time or in a high temperature environment, remove the battery to prevent damage due to leakage.

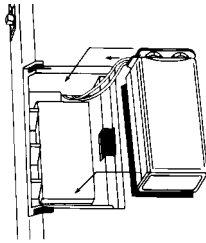

Figure 2-1. Battery Installation

SECTION 3 OPERATION

The Model 871A is designed to work with any type K thermocouple probe or sensor, fitted with an OMEGA miniature thermocouple connector SMP-K-M or industry equivalent.

The Model 872A is designed to work with any type J thermocouple probe or sensor, fitted with an OMEGA miniature connector SMP-J-M or industry equivalent.

3.1 CONTROL AND INDICATORS

Figure 3-1 and Table 3-1 illustrate and describe the controls and indicators on the 871A and 872A.

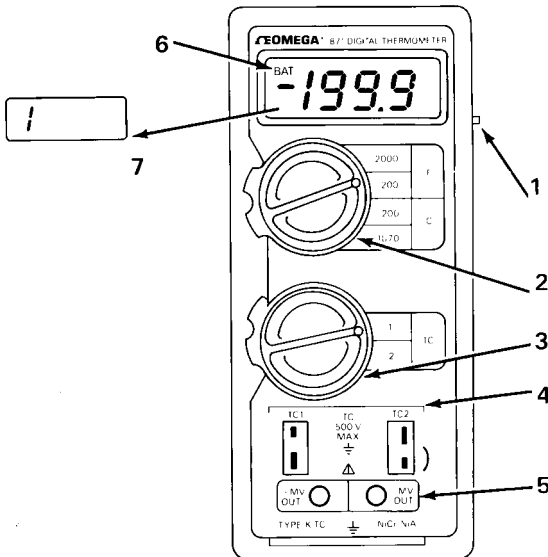

Figure 3-1. Model 871A Controls and Indicators

*Model 872A has same controls and indicators, only range selections differ.

TABLE 3-1
MODEL 871A AND MODEL 872A
CONTROLS AND INDICATORS

ITEM	CONTROL/INDICATOR	FUNCTION
1.	ON/OFF switch	Turns unit on or off.
2.	Scale and range selector	Allows user to select: °F or °C scale, any of four possible thermocouple ranges, and 1.0° or 0.1° resolution.
3.	Thermocouple selector	Allows user to read either of two thermocouples by simply turning the dial.
4.	Thermocouple input jacks	Allows direct connection of two thermocouples to the unit via an OMEGA miniature male connector.
5.	Analog output jack, +mV OUT and -mV OUT	The analog output is a nonlinearized, cold junction compensated, amplified thermocouple output. (Not isolated from selected TC input.) Use a recorder to monitor temperature or a sensitive DMM to make higher resolution reading. Refer to mV output specifications for mV output to temperature ratios.
6.	Low battery indicator	When the battery level is low, BAT will appear in upper left corner of the display. Battery should then be replaced to avoid error erroneous readings due to battery failure.
7.	Overrange/open thermocouple indication	When an overrange indication or open thermocouple condition exists, a 1 followed by blanked digits will appear in the display.

3.2 OPERATING PROCEDURE

1. Turn power on.
2. Select scale and range (see Tables 3-2 and 3-3).
3. Select thermocouple TC1 or TC2.
4. Connect one or two thermocouples to the input jacks.
5. Connect a recorder to the analog output to monitor temperatures, or connect DMM to make high resolution readings, if desired.

TABLE 3-2

MODEL 871A TEMPERATURE RANGE

Range	Span	Resolution
200°F	-40.0° to 199.9°F	0.1°F
2000°F	-40° to 1999°F	1°F
200°C	-40.0° to 199.9°C	0.1°C
1370°C	-40° to 1370°C	1°C

TABLE 3-3

MODEL 872A TEMPERATURE RANGE

Range	Span	Resolution
200°F	-40.0° to 199.9°F	0.1°F
1400°F	-40° to 1400°F	1°F
200°C	-40.0° to 199.9°C	0.1°C
760°C	-40° to 760°C	1°C

SECTION 4 SERVICE INFORMATION

4.1 VERIFICATION CHECK

4.1.1 Functionality Check

Attach the GG-TC-K-24-36-SMP beaded wire thermocouple probe (supplied) to the Model 871A and the GG-TC-J-24-36-SMP beaded wire thermocouple probe (supplied) to the Model 872A. Hold the sensor end between two fingers. The reading should change from ambient to between 77° to 104° F (25° to 40°C).

4.1.2 Accuracy Check

1. Prepare a pure-water ice bath (see paragraph 4.2.3, step 5).
2. Connect a thermocouple probe to input 1 of the unit.
3. Immerse the probe into the pure-water ice bath and allow ten minutes for thermal stabilization.
4. Turn on the instrument and use Tables 4-1 and 4-2 to verify that the readings on each range are within specification.

TABLE 4-1

MODEL 871A RANGE CHART

Range	Allowable Reading
2000°F	32° ± 2°
200°F	32.0° ± 1.8°
1370°C	0° ± 1°
200°C	0.0° ± 1.0°

TABLE 4-2

MODEL 872A RANGE CHART

Range	Allowable Reading
1400°F	32° ± 2°
200°F	32.0° ± 1.8°
760°C	0° ± 1°
200°C	0.0° ± 1.0°

4.2 CALIBRATION FOR MODEL 871A

4.2.1 Equipment Needed

1. DC Voltage Calibrator with 1 ±0.01% of setting ± 20 μ V accuracy.
2. 100: 1 divider: 1.98 kilohm and 20 ohm wirewound resistors with 0.02% ratio accuracy or better.
3. OMEGA TRC III Ice Point Reference Chamber or distilled water ice bath.
4. OMEGA type K TRP Reference Probe or make a thermocouple transition junction (see paragraph 4.2.3).

4.2.2 Environmental Conditions

To meet all specifications, the conditions for calibration should be an ambient temperature 23° ± 1°C; relative humidity less than 80%.

4.2.3 Setup

(Refer to Figure 4-1.)

1. To make a thermocouple transition junction, silver solder a piece of copper wire to each (type K) thermocouple wire and insulate the junction with a waterproof jacket.
2. Connect the thermocouple wires from the type K transition junction to an OMEGA miniature thermocouple connector SMP-K-M.
3. Plug in the miniature connector to input TC1 of the Model 871A.
4. Connect the copper wires to the 100:1 divider (see Figure 4-1) with the copper/wire (positive) junction connected through the 1.98 kilohm resistor, to the dc calibrator positive terminal.
5. Prepare a distilled water ice bath as follows:
 - a. Drill a hole in the cap of a Dewar flask or Thermos™ to accommodate the transition junction.
 - b. Firmly pack the flask with pea-size ice chips made from distilled water and then fill the flask with distilled water.*
 - c. Replace the melted ice with more ice while removing excess water.
 - d. Place cap on the flask and insert the transition junction into the flask. Allow 20 minutes for temperature stabilization.

*Using tap water may cause inaccuracies due to contaminants.

*The 20 Ω resistor must be held at a uniform temperature during calibration.

Figure 4-1. Calibration Setup for Model 871A

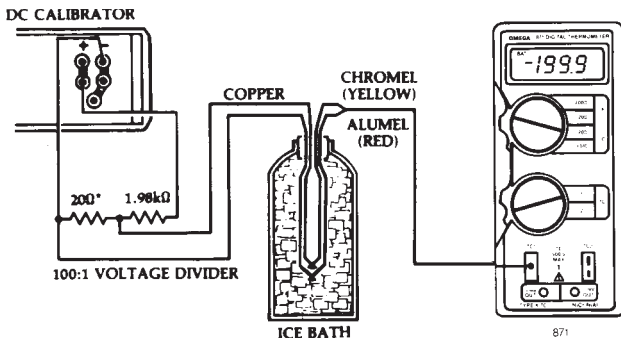

4.2.4 Calibration Procedure

It is not necessary to disassemble the case for calibration. All adjustments are accessible by removing the covers shown in Figure 4-2.

1. Remove the battery and trimmer compartment covers from the Model 871A.
2. Turn the Model 871A on and perform the calibration adjustments listed in Table 4-3.

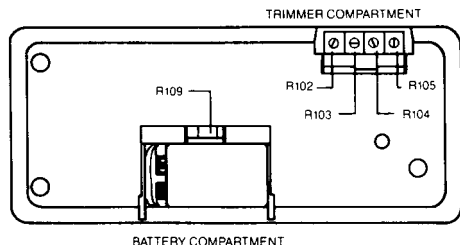

Figure 4-2. Access to Calibration Adjustments

**TABLE 4-3
CALIBRATION ADJUSTMENTS FOR MODEL 871A**

Step	Adjustment	871 Range	Calibrator Setting (V)	Trimmer Adjust	Desired Reading
1	Input Offset Null	220°C	0.0000	R109	00.0°C
2	+ Gain (X1)	1370°C	5.3039	R104	1320°C
3	+ Gain (X10)	200°C	0.6939	R105	170.0°C
4	- Gain	200°C	-0.1527	R103	-40.0°C
5	°F Offset	200°F	0.000	R102	32.0°F

4.3 CALIBRATION FOR MODEL 872A

4.3.1 Equipment Needed

1. DC voltage calibrator with $\pm 0.01\%$ of setting and $\pm 20 \mu\text{V}$ accuracy.
2. 100: 1 divider: 1.98 kilohm and 20 ohm wirewound resistors with 0.02% ratio accuracy or better.
3. OMEGA TRC III Ice Point Reference Chamber or distilled water ice bath.
4. OMEGA type J TRP Reference Probe or make a thermocouple transition junction (see paragraph 4.3.3).

4.3.2 Environmental Conditions

To meet all specifications, the conditions for calibration should be: an ambient temperature of $23^\circ \pm 1^\circ\text{C}$; relative humidity less than 80%.

4.3.3 Setup

1. To make a thermocouple transition junction, silver solder a piece of copper wire to each (type J) thermocouple wire and insulate the junction with a waterproof jacket.
2. Connect the thermocouple wires from the type J transition junction to an OMEGA miniature connector SMP-J-M.

3. Plug in the miniature connector to input TC1 of the Model 872A.
4. Connect the copper wires to the 100:1 divider (see Figure 4-3) with the iron wire connected through the 1.98 kilohm resistor, to the dc calibrator positive terminal.
5. Prepare a distilled water bath as outlined in paragraph 4.2.3, step 5.

*The 20 Ω resistor must be held at a uniform

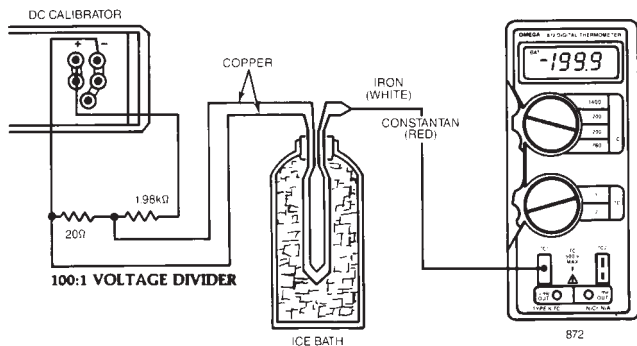

temperature during calibration.

Figure 4-3. Calibration Setup for Model 872A

4.3.4 Calibration Procedure

It is not necessary to disassemble the case for calibration. All adjustments are accessible by removing the covers shown in Figure 4.2.

1. Remove the battery and trimmer compartment covers from the Model 872A.
2. Turn the Model 872A on and perform the calibration adjustments listed in Table 4-4.

**TABLE 4-4
CALIBRATION ADJUSTMENTS FOR MODEL 872A**

Step	Adjustment	872A Range	Calibrator Setting (V)	Trimmer Adjust	Desired Reading
1	Input Offset Null	200°C	0.0000	R109	00.0°C
2	+ Gain (X1)	760°C	4.2922	R104	760°C
3	+ Gain (X10)	200°C	1.02217	R105	190.0°C
4	- Gain	200°C	-.19604	R103	-40.0°C
5	°F Offset	200°F	0.000	R102	32.0°F

DISASSEMBLY FOR MODEL 871A AND MODEL 872A

The PC board and LCD assembly are not secured once the case retaining screws are removed. Be careful not to allow the PC board and LCD assembly to fall out or shift out of position.

1. Place the unit face down on a bench or other similar surface and remove the battery compartment cover. Remove and disconnect the battery. Remove the two #4-40 x 7/8 retaining screws.
2. Grasp the bottom cover at the input jack end and with a lifting and forward pushing motion (see Figure 4-4 and Figure 4-5), carefully remove the bottom cover. While removing the cover, feed the battery connector through the access hole in bottom of the battery compartment.
3. The component side of the PC board is now exposed and the battery can be reconnected for troubleshooting. To read the display, some light downward pressure at the top end of the circuit board may be required in order to make contact through the conductive elastomer strip, between the circuit board and the LCD.
4. To remove the PC board from the top cover, grasp the TC switch assembly and lift until the input jacks become disengaged from the cover. The PC board can now be removed using a slight clockwise motion to free the two switch knobs from their normal positions in the case.
5. The LCD assembly will remain in the top cover when the PC board is removed. Again, be careful not to allow the LCD assembly to fall out accidentally.
6. The two switch knobs can be removed from the PC board assembly by simply pulling them off the switch shafts.
7. The LCD assembly, along with the strip connector, lifts out of the case.
8. To reassemble the unit, reverse the above procedure.

NOTE

Proper alignment of the strip connector is necessary when reinstalling the LCD assembly. Make sure that the conductor side of the strip connector is positioned against the plastic support of the assembly.

WARNING

Be sure to replace the on-off switch cover. Common-mode voltage will be present on the switch, creating a possible hazard if the cover is not replaced

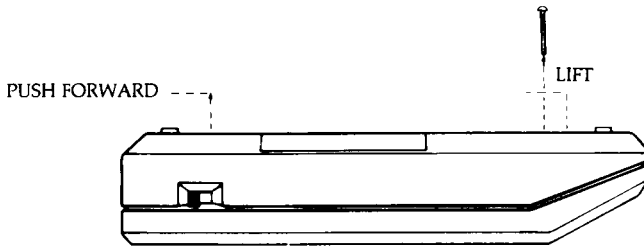

Figure 4-4. Removing the Cover

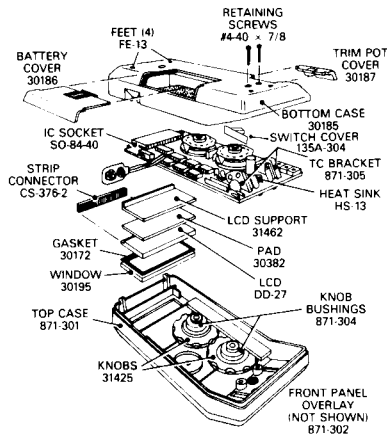

Figure 4-5. Disassembled Model 871A and Model 872A

4.5 TROUBLESHOOTING GUIDE

The troubleshooting information is intended to be used by qualified electronic maintenance personnel who are familiar with the proper use of standard electronic test equipment.

To gain access to the PC board, refer to the first three paragraphs of the disassembly instructions. Utilize the Parts List, Schematic and Component Layout for identifying parts and checkpoint locations. The following checks should be made with the Models 871A and 872A set to the 200°C Range.

4.5.1 DC Voltage Checks For Model 871A

1. Battery: $VBAT > 7\text{ V}$
2. Power Supplies:
V + to \Downarrow (Analog Ground) = $+2.8 \pm 0.4\text{ V}$
V + to \Downarrow (Digital Ground) = $+5 \pm 1\text{ V}$
3. Reference Diode: CR101 to \Downarrow (Analog Ground) = $-1.23 \pm 0.03\text{ V}$
4. Negative Reference Divider: (Reference to \Downarrow Analog Ground)

R119

Pin	mV*	Pin	mV*	Pin	mV*
2	-210	5	-204	8	-195
3	-209	6	-199	9	-186
4	-204	7	-198	10	-173

*The setting of R104 and the tolerances of the resistors within the network (R119) can affect these levels by $\pm 5\%$.

5. Deintegrate Comparators:
U103A PIN 3 to \Downarrow = $150 \pm 25\text{ mV}$
U103B, PIN 6 to \Downarrow = $-150 \pm 25\text{ mV}$
6. Cold Junction Voltage:
(Ambient temperature $25^\circ \pm 3^\circ\text{C}$)
-COM to \Downarrow = $1.0 \pm 0.6\text{ mV}$

4.5.2 DC Voltage Checks For Model 872A

1. Battery: $VBAT > 7\text{ V}$
2. Power Supplies:
V + to \Downarrow (Analog Ground) = $+2.8 \pm 0.4\text{ V}$
V + to \Downarrow (Digital Ground) = $+5 \pm 1\text{ V}$
3. Reference Diode: CR101 to \Downarrow (Analog Ground) = $-1.23 \pm 0.03\text{ V}$
4. Negative Reference Divider: (Reference to \Downarrow Analog Ground)

R119

Pin	mV*	Pin	mV*	Pin	mV*
2	-312	5	-274	8	-267
3	-293	6	-272	9	-254
4	-277	7	-271	10	-242

*The setting of R104 and the tolerances of the resistors within the network (R119) can affect these levels by $\pm 5\%$.

5. Deintegrate Comparators:
U103, Pin 3 to \Downarrow = $190 \pm 30\text{ mV}$
U103B, Pin 6 to \Downarrow = $-180 \pm 30\text{ mV}$
6. Cold Junction Voltage:
(Ambient temperature $25^\circ \pm 3^\circ\text{C}$)
-COM to \Downarrow = $1.3\text{ mV} \pm 0.6$

4.5.3 Waveform Checks For Model 871A

Waveform Checks: Referenced To ↓ (Digital Ground)

Clock	U111, Pin 3	360 kHz,	5V pp	Square Wave
A/D Clock	U112, Pin 5	40 kHz,	5V pp	Rectangular Wave
Ref. Clock 1	U102, Pin 9	60 kHz,	5V pp	Rectangular Wave
Ref. Clock 2	U102, Pin 14	6 kHz,	5V pp	Rectangular Wave
Backplane	U101, Pin 20	50 Hz,	5V pp	Rectangular Wave

4.5.3 Waveform Checks For Model 872A

Waveform Checks: Referenced To ↓ (Digital Ground)

Clock	U111, Pin 3	360 kHz,	5V pp	Square Wave
A/D Clock	U112, Pin 5	40 kHz,	5V pp	Rectangular Wave
Ref. Clock 1	U102, Pin 9	90 kHz,	5V pp	Rectangular Wave
Ref. Clock 2	U102, Pin 14	9 kHz,	5V pp	Rectangular Wave
Backplane	U101, Pin 20	50 Hz,	5V pp	Rectangular Wave

SECTION 5 SPECIFICATIONS FOR MODEL 871A AND MODEL 872A

GENERAL

THERMOCOUPLE INPUTS:	Two, switch selected
ACCURACY:	$\pm 0.25\%$ of reading $+1^{\circ}\text{C}$ ($0.25\% \pm 1.8^{\circ}\text{F}$) for one year, 64° to 82°F (10° to 28°C) ambient
EXTENDED SPAN ACCURACY:	-40° to -55°C : $+2^{\circ}\text{C}$, -0°C
REPEATABILITY:	$\pm 0.2^{\circ}\text{C}$ Typical (one hr., constant ambient temperature)
TEMPERATURE COEFFICIENT:	64° to 82°F (18° to 28°C); Less than $\pm(0.025\%$ of reading $+0.1^{\circ}\text{C}$) 1°C ; for temperatures less than 64°F (18°C) or greater than 82°F (28°C)
MAXIMUM ALLOWABLE TC INPUT OVERLOAD:	35Vdc (42 V peak AC)
NORMAL MODE REJECTION RATIO:	Greater than 45 dB at 50 and 60 Hz
COMMON MODE REJECTION RATIO (1KΩ UNBALANCE):	Greater than 120 dB at dc, 50 and 60 Hz
DISPLAY:	3½ digit LCD, 0.6" height. Polarity and decimal point indication
MAXIMUM COMMON MODE VOLTAGE:	500 V

SPECIFICATION (con't)

ENVIRONMENTAL LIMITS

OPERATING:	32° to 122° F (0° to 50°C), less than 80% relative humidity up to 95°F (35°C), less than 70% relative humidity from 95° to 122°F (35° to 50°C); linearly derate 3% R.H./°C 35° to 60°C.
STORAGE:	-30° to 140°F (-35° TO 60°C), less than 90% relative humidity up to 95°F (35°C); linearly derate 3% R.H./°C 35° to 60°C.
COLD-JUNCTION COMPENSATION:	Semiconductor temperature sensor
INPUT CONNECTIONS:	OMEGA subminiature thermocouple connector (2)
mV OUTPUT CONNECTION:	Dual banana jacks
POWER:	9 V alkaline or carbon-zinc (NEDA 1604) battery
BATTERY LIFE CONTINUOUS:	100 hrs. typical with alkaline battery; 50 hrs. typical with carbon-zinc battery
BATTERY INDICATOR:	Display indicates "BAT" when less than 10% of life remains
DIMENSIONS:	H: 7.0" (178 mm) x W: 3.1" (78 mm) x D: 1.6" (42 mm)
WEIGHT:	10.6 oz. (300 grams)

FOR MODEL 871A

TEMPERATURE SENSOR:	Type K (NiCr-NiAl) thermocouple
RANGES:	200°F, 2000°F, 200°C, 1370°C
TEMPERATURE SPAN:	-40.0° to 199.9°F, -40° to 1999°F -40.0° to 199.9°C, -40° to 1370°C
RESOLUTION:	0.1°F, 1°F, 0.1°C, 1°C
INPUT CURRENT:	200nA maximum
CONVERSION PERIOD:	400 ms (2.5 readings per sec)
OVERRRANGE AND OPEN THERMOCOUPLE INDICATION:	Display blanked except for overrange digit

SPECIFICATION (con't)

mV OUTPUT:

Non-linearized, cold-junction compensated, amplified thermocouple output (Not isolated from selected TC input.)

On °C Scale:

1mV/°C on 200° range

0.1mV/°C on 1370° range

0°C = 0mV output

On °F Scale:

5/9 mV/°F on 200° range

5/90 mV/°F on 2000° range

0°F = 0mV output

mV OUTPUT ACCURACY (18° - 28°C)

±(3% + 1mV) on 200° ranges;

±(3% + 0.1mV) on High ranges

Includes TC non-linearity, excludes TC errors. Output resistance: 10k ohms

mV OUTPUT TEMPERATURE COEFFICIENT (0° - 18°C & 28° - 50°C):

Less than (0.1 x accuracy specification)/°C

mV OUTPUT PROTECTION:

35 V dc (42 V peak) max; +mV to -mV and selected TC input to +mV or -mV.

THERMOCOUPLE LINEARIZATION:

Multi-scope A/D with 11 piecewise linear segments between -40° and 1370°C

FOR MODEL 872A

TEMPERATURE SENSOR:

Type J (Fe-CuNi) thermocouple

RANGES:

200°F, 1400°F, 200°C, 760°C

TEMPERATURE SPAN:

-40.0° TO 199.9°F, -40° to 1400°F

-40.0° TO 199.9°C, -40° to 760°C

RESOLUTION:

0.1°F, 1°F, 0.1°C, 1°C

INPUT CURRENT:

25 nA typical; 50 nA max

CONVERSION PERIOD:

400 ms (2.5 readings/sec.)

OVERRANGE AND OPEN THERMOCOUPLE INDICATION:

3 least significant digits blanked

SPECIFICATION (con't)

mV OUTPUT:

Non-linearized, cold-junction compensated, amplified thermocouple output (Not isolated from selected TC input.)

On °C Scale:

1mV/°C on 200° range

0.1mV/°C on 760° range

0°C = 0mV output

On °F Scale:

5/9 mV/°F on 200° range

5/90 mV/°F on 1400° range

0°F = 0mV output

mV OUTPUT ACCURACY

(18° - 28° C)

±(5% + 1mV) on 200° ranges;

±(5% + 0.1mV) on High ranges

Includes TC non-linearity, excludes TC errors. Output resistance: 10k ohms

mV OUTPUT TEMPERATURE

COEFFICIENT (0° - 18°C

& 28° - 50°C)

Less than (0.1 x accuracy specification)/°C

mV OUTPUT PROTECTION:

35 V dc (42 V peak) max; +mV to -mV and selected thermocouple input to +mV or -mV.

THERMOCOUPLE LINEARIZATION:

Multi-scope A/D with nine piecewise linear segments between -40° and 760° C

5.1 PARTS LIST

Circuit Desig.	Description	Circuit Desig.	Description
BT101	Battery, 9V NEDA 1604	R102	Pot, 100 kΩ
C101	Cap, 0.22 μF, 100 V, Polyester	R103	Pot, 2 kΩ
C102*	Cap, 0.1 μF, 160 V,	R104	Pot, 1 kΩ
	Polypropylene	R105	Pot, 500 Ω
C102**	Cap, 0.1 μF, 100 V,	R106*	Resistor, 180 kΩ, 5%, 1/4W,
	Polypropylene		Comp
C103	Cap, 470pF, 1000 V, Ceramic	R106**	Resistor, 240 kΩ, 5%, 1/4W,
	Disc		Comp
C104	Cap, 220pF, 1000 V, Ceramic	R107	Resistor, 47 kΩ, 5%, 1/4W,
	Disc		Comp
C105, 106	Cap, 10 μF, 16 V, Aluminum	R108	Resistor, 470 kΩ, 5%, 1/4W,
	Electrolytic		Comp
C107	Cap, 33pF, 1000 V, Ceramic	R109	Pot, 2 kΩ
	Disc	R110	Thick Film Resistor Network
C108	Cap, 47pF, 1000 V, Ceramic	R111	Resistor, 10 kΩ, 10%, 2W,
	Disc		Comp
C109*	Cap, 0.1 μF, 16 V, Ceramic	R112	Resistor, 10 MΩ, 10%, 1/4W,
C109**	Cap, 0.1 μF, 50 V, Ceramic		Comp
C110**	Cap, 4.7 μF, 16 V, Aluminum	R113	Resistor, 5.1 kΩ, 5%, 1/4W,
	Electrolytic		Comp
GR101	Diode, Low Voltage Reference	R114*	Resistor, 1 MΩ, 5%, 1/4W,
DS101	Liquid Crystal Display, 3½ digit		Comp
J101, 102	TC Connector, Female	R114**	Resistor, 1 MΩ, 10%, 1/4W,
J103, J104**	Jack, Female SMP Connector		Comp
J104, 105*	Jack, Female	R115, 116*	Resistor, Selected, 1%, 1/8W,
J105**	Connector, Battery		Mtf.
J106*	Connector, Battery	R115**	R115 and U110 are a selected
Q101, 102	Transistor, NPN, Switch, 2N3904		set
R101	Thick Film Resistor Network		

5.1 PARTS LIST (continued)

Circuit Desig.	Description	Circuit Desig.	Description
R116**	R116, R122, and U109 are a selected set	U101	3 1/2 Digit Single Chip A/D Converter
R117	Thick Film Resistor Network	U102	Dual Synchronous Up Counter
R118*	Resistor, 150 kΩ, 5%, 1/4W, Comp	U103, U104*	Low Power JFET Input Op Amp
R118**	Resistor, 5.6 kΩ, 5%, 1/4W, Comp	U103, U104**	Dual JFET Input Op Amp
R119	Thick Film Resistor Network	U105	COS/MOS Quad Bilateral Switch
R120	Resistor, 10 kΩ, 5%, 1/4W, Comp	U106	CMOS Quad Exclusive OR Gate
R121**	Resistor, 10.0 kΩ, 6.1%, Metal Film	U107	Dual "D" Type Flip-Flop
R122†	Resistor, Selected, 5%, 1/4W, Comp	U108	14 Stage Binary Counter
R122**	R116, R122, and U109 are a selected set	U109*	Linear Op Amp
R123*	Resistor, 324 kΩ, 1%, 1/8W, Mtf.	U109**	R116, R222, and U109 are a selected set
R123**	Resistor, 316 kΩ, 1%, 1/8W, Mtf.	U110*	Current Source
R124**	Resistor, 10.0 Ω, 0.1%, Metal film	U110**	R115 and U110 are a selected set
R126*	Resistor, 10 kΩ, 0.1%, MF	U111	Quad, 2 Input NOR Gate
R127*	Resistor, 9.9 kΩ, 0.1%, MF	U112	COS/MOS Divide by "N" Counter
R128*	Resistor, 4.7 kΩ, 5%, 1/4 W, Comp	U113	Quad, 2 Input, AND Gate
S101	Switch, Rotary	U114	Analog Multiplexer
S102	Switch, Rotary	Y101	Resonator, 360 kHz
S103	Switch, SPDT, ON-OFF		
TC-1, 2	TC Cable		

† Value selected during calibration at factory.
 * For Model 871A only
 ** For Model 872A only
 To order parts, specify model and circuit designation.

COMPONENT LAYOUT FOR MODEL 871A

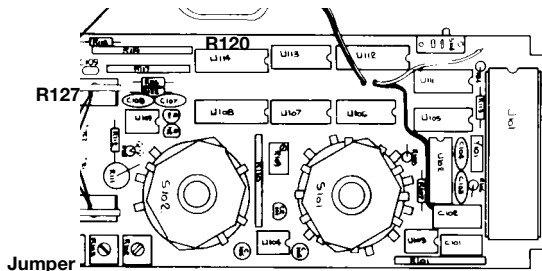

COMPONENT LAYOUT FOR MODEL 872A

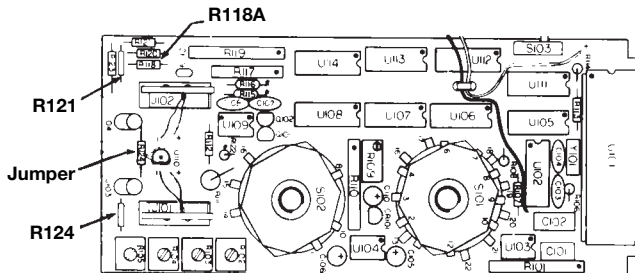

SCHEMATIC MODEL 871A DIGITAL THERMOMETER

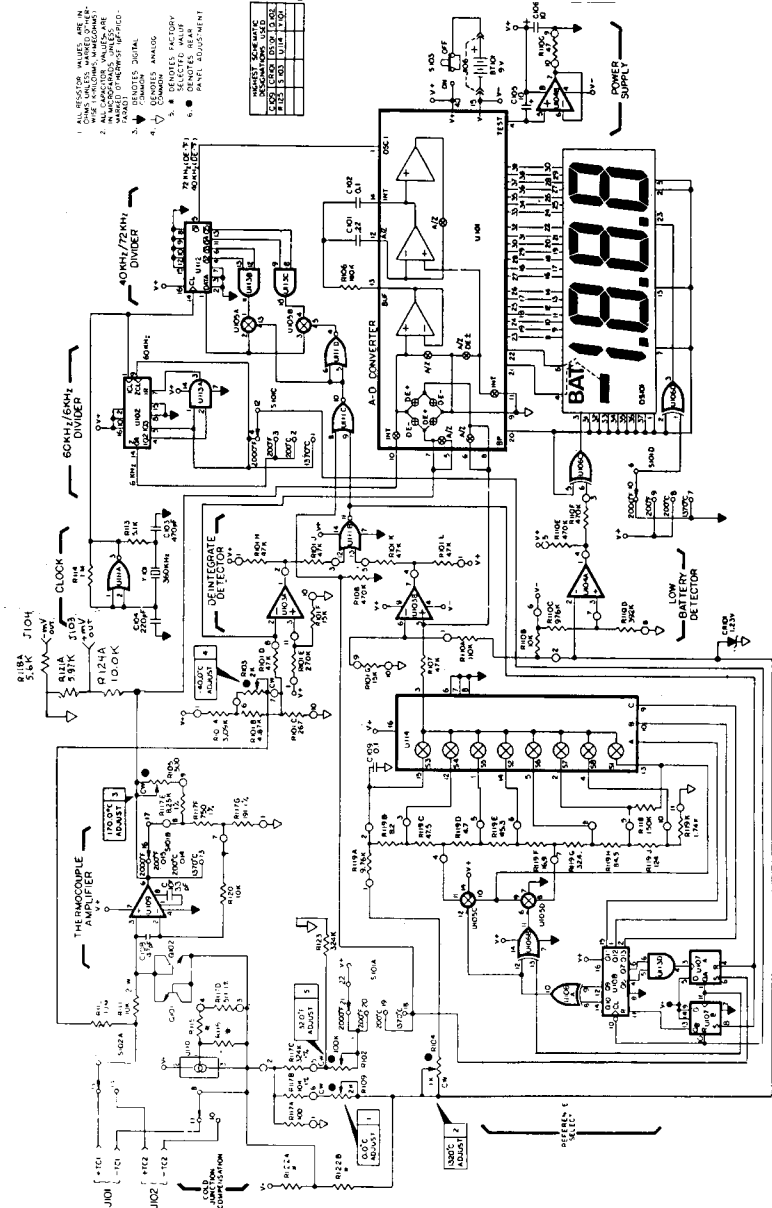

SCHEMATIC MODEL 872A DIGITAL THERMOMETER

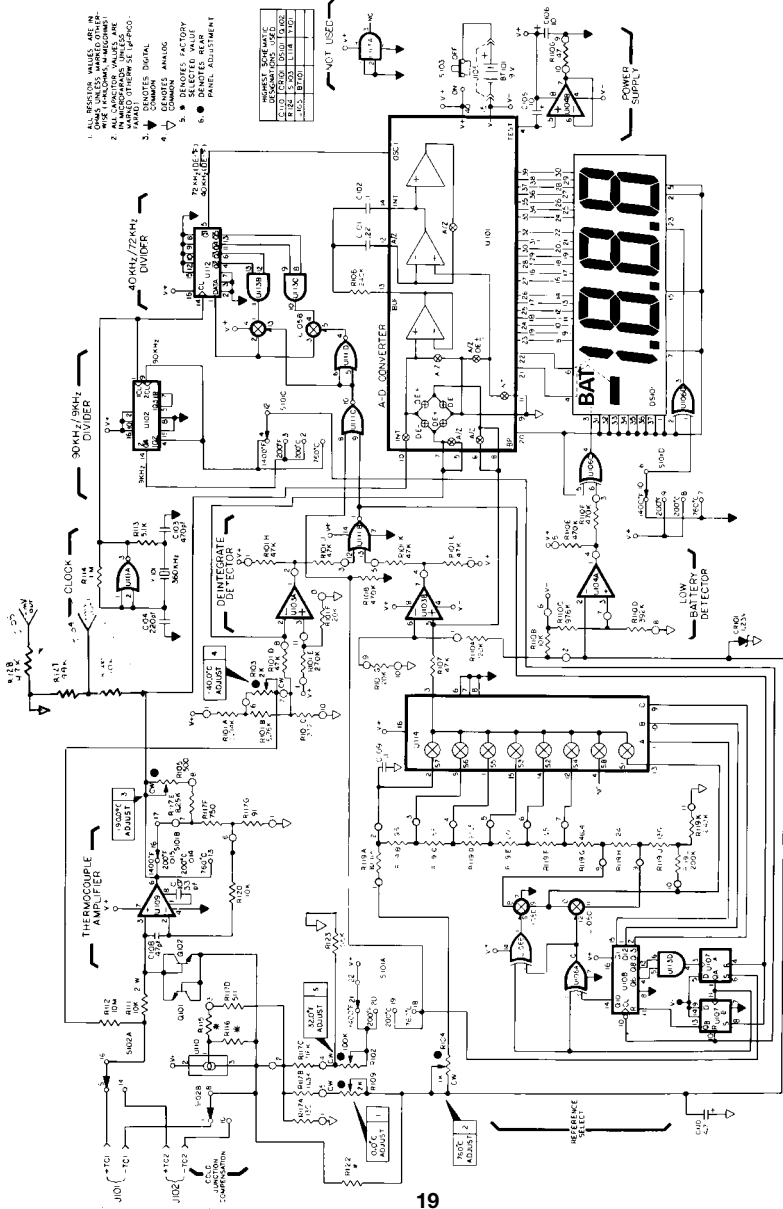



WARRANTY/DISCLAIMER

OMEGA ENGINEERING, INC. warrants this unit to be free of defects in materials and workmanship for a period of **13 months** from date of purchase. OMEGA Warranty adds an additional one (1) month grace period to the normal **one (1) year product warranty** to cover handling and shipping time. This ensures that OMEGA's customers receive maximum coverage on each product.

If the unit should malfunction, it must be returned to the factory for evaluation. OMEGA's Customer Service Department will issue an Authorized Return (AR) number immediately upon phone or written request. Upon examination by OMEGA, if the unit is found to be defective it will be repaired or replaced at no charge. OMEGA's WARRANTY does not apply to defects resulting from any action of the purchaser, including but not limited to mishandling, improper interfacing, operation outside of design limits, improper repair, or unauthorized modification. This WARRANTY is VOID if the unit shows evidence of having been tampered with or shows evidence of being damaged as a result of excessive corrosion; or current, heat, moisture or vibration; improper specification; misapplication; misuse or other operating conditions outside of OMEGA's control. Components which wear are not warranted, including but not limited to contact points, fuses, and triacs.

OMEGA is pleased to offer suggestions on the use of its various products. However, OMEGA neither assumes responsibility for any omissions or errors nor assumes liability for any damages that result from the use of its products in accordance with information provided by OMEGA, either verbal or written. OMEGA warrants only that the parts manufactured by it will be as specified and free of defects. OMEGA MAKES NO OTHER WARRANTIES OR REPRESENTATIONS OF ANY KIND WHATSOEVER, EXPRESSED OR IMPLIED, EXCEPT THAT OF TITLE, AND ALL IMPLIED WARRANTIES INCLUDING ANY WARRANTY OF MERCHANTABILITY AND FITNESS FOR A PARTICULAR PURPOSE ARE HEREBY DISCLAIMED. LIMITATION OF LIABILITY: The remedies of purchaser set forth herein are exclusive and the total liability of OMEGA with respect to this order, whether based on contract, warranty, negligence, indemnification, strict liability or otherwise, shall not exceed the purchase price of the component upon which liability is based. In no event shall OMEGA be liable for consequential, incidental or special damages.

CONDITIONS: Equipment sold by OMEGA is not intended to be used, nor shall it be used: (1) as a "Basic Component" under 10 CFR 21 (NRC), used in or with any nuclear installation or activity; or (2) in medical applications or used on humans. Should any Product(s) be used in or with any nuclear installation or activity, medical application, used on humans, or misused in any way, OMEGA assumes no responsibility as set forth in our basic WARRANTY/DISCLAIMER language, and additionally, purchaser will indemnify OMEGA and hold OMEGA harmless from any liability or damage whatsoever arising out of the use of the Product(s) in such a manner.

RETURN REQUESTS / INQUIRIES

Direct all warranty and repair requests/inquiries to the OMEGA Customer Service Department. BEFORE RETURNING ANY PRODUCT(S) TO OMEGA, PURCHASER MUST OBTAIN AN AUTHORIZED RETURN (AR) NUMBER FROM OMEGA'S CUSTOMER SERVICE DEPARTMENT (IN ORDER TO AVOID PROCESSING DELAYS). The assigned AR number should then be marked on the outside of the return package and on any correspondence.

The purchaser is responsible for shipping charges, freight, insurance and proper packaging to prevent breakage in transit.

FOR **WARRANTY** RETURNS, please have the following information available BEFORE contacting OMEGA:

1. P.O. number under which the product was PURCHASED,
2. Model and serial number of the product under warranty, and
3. Repair instructions and/or specific problems relative to the product.

FOR **NON-WARRANTY** REPAIRS, consult OMEGA for current repair charges. Have the following information available BEFORE contacting OMEGA:

1. P.O. number to cover the COST of the repair,
2. Model and serial number of product, and
3. Repair instructions and/or specific problems relative to the product.

OMEGA's policy is to make running changes, not model changes, whenever an improvement is possible. This affords our customers the latest in technology and engineering.

OMEGA is a registered trademark of OMEGA ENGINEERING, INC.

© Copyright 1996 OMEGA ENGINEERING, INC. All rights reserved. This document may not be copied, photocopied, reproduced, translated, or reduced to any electronic medium or machine-readable form, in whole or in part, without prior written consent of OMEGA ENGINEERING, INC.

Where Do I Find Everything I Need for Process Measurement and Control? OMEGA...Of Course!

TEMPERATURE

- ☑ Thermocouple, RTD & Thermistor Probes, Connectors, Panels & Assemblies
- ☑ Wire: Thermocouple, RTD & Thermistor
- ☑ Calibrators & Ice Point References
- ☑ Recorders, Controllers & Process Monitors
- ☑ Infrared Pyrometers

PRESSURE, STRAIN AND FORCE

- ☑ Transducers & Strain Gauges
- ☑ Load Cells & Pressure Gauges
- ☑ Displacement Transducers
- ☑ Instrumentation & Accessories

FLOW/LEVEL

- ☑ Rotameters, Gas Mass Flowmeters & Flow Computers
- ☑ Air Velocity Indicators
- ☑ Turbine/Paddlewheel Systems
- ☑ Totalizers & Batch Controllers

pH/CONDUCTIVITY

- ☑ pH Electrodes, Testers & Accessories
- ☑ Benchtop/Laboratory Meters
- ☑ Controllers, Calibrators, Simulators & Pumps
- ☑ Industrial pH & Conductivity Equipment

DATA ACQUISITION

- ☑ Data Acquisition & Engineering Software
- ☑ Communications-Based Acquisition Systems
- ☑ Plug-in Cards for Apple, IBM & Compatibles
- ☑ Datalogging Systems
- ☑ Recorders, Printers & Plotters

HEATERS

- ☑ Heating Cable
- ☑ Cartridge & Strip Heaters
- ☑ Immersion & Band Heaters
- ☑ Flexible Heaters
- ☑ Laboratory Heaters

ENVIRONMENTAL MONITORING AND CONTROL

- ☑ Metering & Control Instrumentation
- ☑ Refractometers
- ☑ Pumps & Tubing
- ☑ Air, Soil & Water Monitors
- ☑ Industrial Water & Wastewater Treatment
- ☑ pH, Conductivity & Dissolved Oxygen Instruments