

**MODELS 5830 and 5831**  
**Precision Thermistor Thermometers**

## WARRANTY/DISCLAIMER

OMEGA ENGINEERING, INC. warrants this unit to be free of defects in materials and workmanship for a period of **13 months** from date of purchase. OMEGA Warranty adds an additional one- (1) month grace period to the normal **one- (1) year product warranty** to cover handling and shipping time. This ensures that OMEGA's customers receive maximum coverage on each product.

If the unit should malfunction, it must be returned to the factory for evaluation. OMEGA's Customer Service Department will issue an Authorized Return (AR) number immediately upon phone or written request. Upon examination by OMEGA, if the unit is found to be defective it will be repaired or replaced at no charge. OMEGA's WARRANTY does not apply to defects resulting from any action of the purchaser, including but not limited to mishandling, improper interfacing, operation outside of design limits, improper repair, or unauthorized modification. This WARRANTY is VOID if the unit shows evidence of having been tampered with or shows evidence of being damaged as a result of excessive corrosion; or current, heat, moisture or vibration; improper specification; misapplication; misuse or other operating conditions outside of OMEGA's control. Components, which wear, are not warranted, including but not limited to contact points, fuses, and triacs.

**OMEGA is pleased to offer suggestions on the use of its various products. However, OMEGA neither assumes responsibility for any omissions or errors nor assumes liability for any damages that result from the use of its products in accordance with information provided by OMEGA, either verbal or written. OMEGA warrants only that the parts manufactured by it will be as specified and free of defects. OMEGA MAKES NO OTHER WARRANTIES OR REPRESENTATIONS OF ANY KIND WHATSOEVER, EXPRESSED OR IMPLIED, EXCEPT THAT OF TITLE, AND ALL IMPLIED WARRANTIES INCLUDING ANY WARRANTY OF MERCHANTABILITY AND FITNESS FOR A PARTICULAR PURPOSE ARE HEREBY DISCLAIMED. LIMITATION OF LIABILITY: The remedies of purchaser set forth herein are exclusive and the total liability of OMEGA with respect to this order, whether based on contract, warranty, negligence, indemnification, strict liability or otherwise, shall not exceed the purchase price of the component upon which liability is based. In no event shall OMEGA be liable for consequential, incidental or special damages.**

CONDITIONS: Equipment sold by OMEGA is not intended to be used, nor shall it be used: (1) as a "Basic Component" under 10 CFR 21 (NRC), used in or with any nuclear installation or activity; or (2) in medical applications or used on humans. Should any Product(s) be used in or with any nuclear installation or activity, medical application, used on humans, or misused in any way, OMEGA assumes no responsibility as set forth in our basic WARRANTY/DISCLAIMER language, and additionally, purchaser will indemnify OMEGA and hold OMEGA harmless from any liability or damage whatsoever arising out of the use of the Product(s) in such a manner.

## RETURN REQUESTS/INQUIRES

Direct all warranty and repair request/inquiries to the OMEGA Customer Service Department. **BEFORE RETURNING ANY PRODUCT (S) TO OMEGA, PURCHASER MUST OBTAIN AN AUTHORIZED RETURN (AR) NUMBER FROM OMEGA'S CUSTOMER SERVICE DEPARTMENT (IN ORDER TO AVOID PROCESSING DELAYS).** The assigned AR number should then be marked on the outside of the return package and on any correspondence.

The purchaser is responsible for shipping charges, freight, insurance and proper packaging to prevent breakage in transit.

FOR WARRANTY RETURNS, please have the following information available BEFORE contacting OMEGA:

1. P.O. number under which the product was PURCHASED,
2. Model and serial number of the product under warranty, and
3. Repair instructions and/or specific problems relative to the product.

FOR NON-WARRANTY REPAIRS, consult OMEGA for current repair charges. Have the following information available BEFORE contacting OMEGA:

1. P.O. number to cover the COST of the repair,
2. Model and serial number of product, and
3. Repair instructions and/or specific problems relative to the product.

## IMPORTANT INFORMATION

### Safety Summary

This instrument is designed to prevent accidental shock to operator when properly used. However, no engineering design can ensure the safety of an instrument used negligently. **Therefore, read this manual carefully and completely prior to operating the instrument.** Failure to do so could seriously damage the instrument or injure the operator. Standard safety precautions must be used during installation and operation.

### Important Messages

- <WARNING> Denotes a hazardous procedure or condition which, if ignored, could injure or be fatal to the operator.
- <CAUTION> Denotes a hazardous procedure or condition which, if ignored, could damage or destroy the instrument.
- <IMPORTANT> Denotes a procedure or condition which is essential to the correct operation of the instrument.
- <NOTE> Specifies supplementary and perhaps essential information which should be recognized in relation to a particular procedure or condition.

### Shock Hazard (Industry Standard)

The definition of "Shock Hazard" (as defined in Underwriters Laboratories Radio and Television Receiving Appliances Standards for Safety, 12<sup>th</sup> ed., dated June 25, 1969) is provided for the safe operation of the unit.

"Shock hazard shall be considered to exist at any part involving a potential of between 42.4 volts peak and 40 kilovolts peak in the following cases:

- A. If the current through a load of not less than 500 ohms exceeds 300 milliamperes after 0.0003 second.
- B. If the time required for the current through a load of not less than 500 ohms to decrease to .5 milliamperes is between 0.1 and 0.2 seconds, and the total quantity of electricity passed through the load up to that time exceeds 4 millicoulombs.
- C. If the time required for the current through a load of not less than 500 ohms to decrease to 5 milliamperes is between 0.03 and 0.1 seconds, and the total quantity of electricity passed through the load up to that time exceeds  $75T-350T^2$  millicoulombs, where T is the time in seconds.

### **For Your Information . . .**

1. *Omega Engineering, Inc.* claims proprietary right to the material disclosed herein. This manual is issued in confidence for engineering information only and may not be reproduced or used to manufacture anything shown without direct written permission from *Omega Engineering, Inc.* to user.
2. Specifications, Parts Lists, Component Layouts, and Schematics are subject to change without notice.
3. The term's "instrument", "unit", and "thermometer" are used synonymously throughout this manual.

## TABLE OF CONTENTS

<b>IMPORTANT INFORMATION</b> .....	1
<b>Section 1     PRODUCT DESCRIPTION</b> .....	5
1.1 Instrument Identification .....	5
1.2 Accessories .....	6
1.3 Options .....	6
1.4 Technical Characteristics.....	6
1.5 Probe Specifications and Characteristics.....	7
<b>Section 2     SETTING UP YOUR MODEL 5830/5831</b> .....	9
2.1 Unpacking and Inspection .....	9
2.2 Connecting the Thermometer to a Source of Power .....	9
2.3 Connecting the Thermistor Probes.....	11
<b>Section 3     OPERATION</b> .....	12
3.1 Displaying Thermistor Probe Readings .....	12
3.2 Converting Between Fahrenheit and Centigrade .....	12
3.3 Displaying Measurement Differences.....	13
3.4 Displaying Measurement Averages .....	13
3.5 Scanning Two or More Probe Measurements .....	14
3.6 Displaying Maximum Temperature Reading .....	14
3.7 Displaying Minimum Temperature Reading.....	15
3.8 Resetting MAX and MIN .....	15
3.9 Freezing the Display.....	15
3.10 Switching from One Mode to Another.....	15
3.11 Using the Analog Output (Option A).....	16
3.12 Prompts and Error Messages .....	16
<b>Section 4     MAINTENANCE</b> .....	17
4.1 Inspecting Your Model <b>5830/5831</b> .....	17
4.2 Calibrating Your Model <b>5830/5831</b> .....	17
4.3 Troubleshooting Your Model <b>5830/5831</b> .....	18

## MODELS 5830 AND 5831

### Section 1 PRODUCT DESCRIPTION

Your Model **5830** or **5831** Digital Thermistor Thermometer (Figure 1) is a portable instrument, which will measure and display up to five different temperature readings from  $-30$  to  $100$  °C ( $-22$  to  $212$  °F). The **5830/5831** reads thermistor temperature probes and displays the readings on a five-digit liquid-crystal display on the front panel. Each thermistor probe plugs into its own jack in the back of the instrument and is represented by a front panel light and a labeled membrane key beneath the liquid-crystal temperature display. When you press one or more of the front panel probe keys, its corresponding light comes on to show that it has been selected and is currently active.

#### 1.1 Instrument Identification

The specification tag on the bottom of the instrument gives the instrument model number, serial number, and other pertinent data.

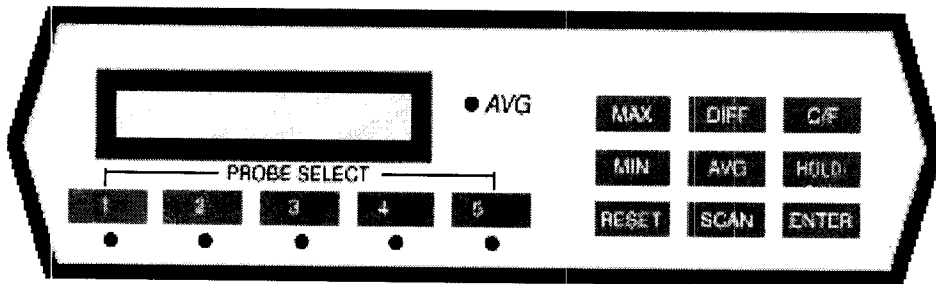

The membrane keyboard on the front panel contains the keys that control the measurement, calculation, and display of the instrument readings:

- individual readings at four readings-per-second for any one of the five probes;
- minimum and maximum readings for each probe;
- the instantaneous average for readings from two, three, four, or five probes, and the minimum and maximum average;
- the difference in readings between any two probes, and the minimum and maximum difference;
- sequential readings of two, three, four, or five probes in any specified scanning order.

You may select the probes to be read, the readings to be averaged or differenced, and the probes to be scanned. You may also freeze any displayed reading for as long as you like.

The Model **5830/5831** can be line-powered (115V or 230V, 50/60 Hz AC power source) or battery operated via an internal, rechargeable battery pack.

## 1.2 Accessories

- THERMISTOR PROBES

Your Model **5830/5831** accepts the OEMGA 400 Series Thermistor (44004 or equivalent) probes and the OMEGA 700 Series Thermistor (44018 or equivalent) probes. Section 2.3, connecting the Thermistor Probes, describes probe installation procedures.

- CARRYING CASE

The carrying case protects your thermometer and provides storage space for probes, the AC adapter, spare fuses, and the instruction manual. The instrument cannot be operated in its case; it must be removed to function properly.

## 1.3 Options

- BATTERY PACK

The battery pack consists of eight AA nickel-cadmium batteries, a spacer pad and one releasable tie strap.

**CAUTION:** Use ONLY rechargeable nickel-cadmium batteries.

- ANALOG OUTPUT (Option A)

The analog output option gives you the ability to connect your Model **5830/5831** Thermometer to a strip chart recorder (for example) to give you a hard copy record of temperature readings over time. Section 3.11, using the Analog Output, describes this option and tells you how to use it.

## 1.4 Technical Characteristics

**RANGE**        -30 TO 100 °C  
                  -22 TO 212 °F

### RESOLUTION

<b>5830</b>	0.1 °C or °F
<b>5831</b> with Series 700 probe	0.01 °C or °F
<b>5831</b> with Series 400 probe from -30 to 70 °C:	0.01 °C or °F
<b>5831</b> with Series 400 probe from 70 to 100 °C:	0.02 °C or °F

## **INSTRUMENT ACCURACY**

$\pm 0.20$  °C from  $-30$  to  $100$  °C

$\pm 0.36$  °F from  $-22$  to  $212$  °F

## **SYSTEM ACCURACY**

Instrument accuracy + probe accuracy

<b>INPUTS:</b>	Five-rear panel input jacks for thermistor probes
<b>SAMPLING RATE:</b>	Four per second nominal
<b>SCAN RATE:</b>	Each probe is displayed for approximately 3 seconds in the scan mode
<b>BATTERY CAPACITY:</b>	Eight hours minimum continuous operation; 16 hours recharge from full discharge
<b>OPERATING TEMPERATURE:</b>	$0$ °C to $+50$ °C
<b>POWER REQUIREMENTS:</b>	115/230 VAC, 50/60 Hz using external AC adapter, or 8 AA Ni-Cd batteries
<b>ADAPTER SPECS:</b>	Outputs 10 VAC at 100 ma.
<b>DIMENSIONS:</b>	7.25" W x 7.9" D x 2.4" H
<b>WEIGHT:</b>	2 pounds
<b>DISPLAY:</b>	6-digit liquid crystal display. Characters are 7 segment with decimal point, 1/2" high.

## **OPTION A (ANALOG OUTPUT)**

10mV per degree (C or F)  $\pm 2\%$ , 600 $\Omega$  maximum load. Model 5831 only requires minimum change of 0.03 degree to change analog output.

## **1.5 Probe Specifications and Characteristics**

The 5830/5831 accepts both the OMEGA 400 Series Thermistor (44004 or equivalent) probes and the 700 Series Thermistor (44018 or equivalent) probes. The following is a selection of some of the available probes. The OL-700 probes are 700 Series Thermistors; the ON-400 probes are 400 Series Thermistors. For a complete listing refer to the OMEGA COMPLETE TEMPERATURE MEASUREMENT HANDBOOK AND ENCYCLOPEDIA.

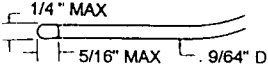
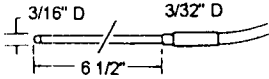
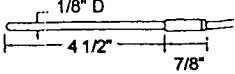
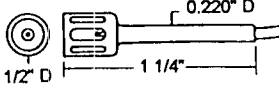
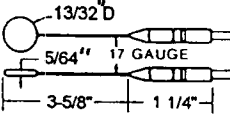
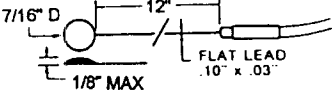
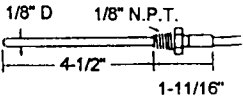
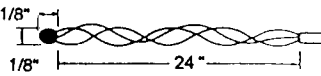

<u>Probe No.</u>	<u>Description</u>	<u>Time Constant</u>	<u>Configuration</u>
OL-701-PP ON-401-PP	<b>General Purpose.</b> Rugged, vinyl probe. Used in air when fast response not required, and for short-term water and sub-soil readings.	7.0 sec	
OL-702-PP ON-402-PP	<b>Small Flexible Vinyl.</b> Cuvette temperatures. Vinyl sheath and tip. General purpose measurement.	3.2 sec	
OL-703-PP ON-403-PP	<b>Tubular.</b> For rugged duty in liquid immersion. Stainless steel 1/8 inch diameter.	3.4 sec	
OL-705-PP ON-405-PP	<b>Air Temperature.</b> Test rooms, incubators, remote air readings, gas stream, etc. Stainless steel cage around epoxy encapsulated thermistor.	10 sec	
OL-708-PP ON-408-PP	<b>Banjo Surface Temperature.</b> Water bath, and flat surface temperature. Excellent for many air temperature applications. Handle aids probe use. Stainless steel.	0.6 sec	
OL-709-PP ON-409-PP	<b>Attachable Surface Temperature.</b> Tape on flat surfaces. Stainless steel cap, epoxy backed.	1.1 sec	
OL-710-PP ON-410-PP	<b>Tubular With Fitting.</b> For readings in pipes or closed vessels. Stainless steel.	3.4 sec	
OL-731-PP	<b>General Purpose.</b> Non-immersible, epoxy-tipped probe. Probe can be potted in place. Suitable for surface temperature measurement. Not electrically isolated.	0.6	

The time constants expressed represent the time required to reach 63% of a sudden temperature change in a well stirred water bath. Approximately 5 time constants are required to reach 99% of a total change.

## Section 2     **SETTING UP YOUR MODEL 5830/5831**

### 2.1     **Unpacking and Inspection**

- Examine the shipping carton for any sign of damage. If the carton was not intact when you received it, file a complaint with the carrier before you use the instrument.
- Check the contents of the shipping carton. In addition to this manual, you should have received:
  - (1) Model **5830** or **5831** with carrying handle (see Figure 1)
  - (1) AC adapter
  - (1) Carrying case (if ordered)
  - (1) Analog Output Connector (if ordered)
  - Thermistor probes (if ordered)
- If your thermometer seems to be in good condition, read this manual before using the instrument. Pay close attention to the **IMPORTANT INFORMATION**, found on pages 1 and 2.
- Save the shipping carton and packing materials to use when you store or ship your instrument.
- If you must return your instrument, contact Omega Engineering Customer Service at (203) 359-1660.

### 2.2     **Connecting the Thermometer to a Source of Power**

Model **5830/5831** will operate on 115V or 230V AC or on battery power. If you ordered the standard unit, it will be a “line-operating” instrument with no batteries installed when you receive it. If you order the battery-pack option, you will receive your Model **5830** with batteries already installed.

#### 2.2.1   **To Use Line Power**

Make sure the 115/230-volt switch on the adapter is in the proper position to match the line voltage, then connect the adapter to the thermometer and plug it into line voltage.

### **2.2.3 To Operate with a Battery Pack**

1. When you use your battery pack for the first time, connect the thermometer to an AC power source (as described in Section 2.2.1 To Use Line Power) and fully charge the batteries. Depending on the state of discharge, this could require up to 16 hours.
2. Whenever the instrument has not been used for several weeks, connect it to an AC power source and let the batteries charge for about 15 minutes.
3. Remove the AC adapter, Your **5830/5831** is ready for battery operation, although the batteries may not be fully charged (to fully recharge the batteries can require up to 16 hours, depending on their state of discharge).
4. Attach the AC adapter to the instrument's rear panel and plug into an appropriate receptacle whenever you want to use line power again.

### **2.2.4 Notes and Cautions About Battery Operation**

- You may damage your batteries if you try to operate them after they are fully discharged. They provide extremely stable output for about eight hour's nominal.
- Recharge batteries by attaching the AC adapter to the rear panel and plugging it into an appropriate AC power receptacle. To fully recharge the batteries requires approximately 16 hours.
- Use only rechargeable nickel-cadmium batteries.

## 2.3 Connecting the Thermistor Probes

When you receive your instrument, it is factory set to an OMEGA 700 Series Thermistor Probe (with 44018 or equivalent thermistor) but can be set to accept the 400 Series Thermistor Probe (with 44004 or equivalent thermistor). Follow this procedure to change the thermistor type:

### 2.2.5 Probe Selection

1. Remove the screws that secure the cover and remove the cover.
2. Find the internal probe select jumper (S2, located in the lower left quadrant on the main circuit board in Figure 2).

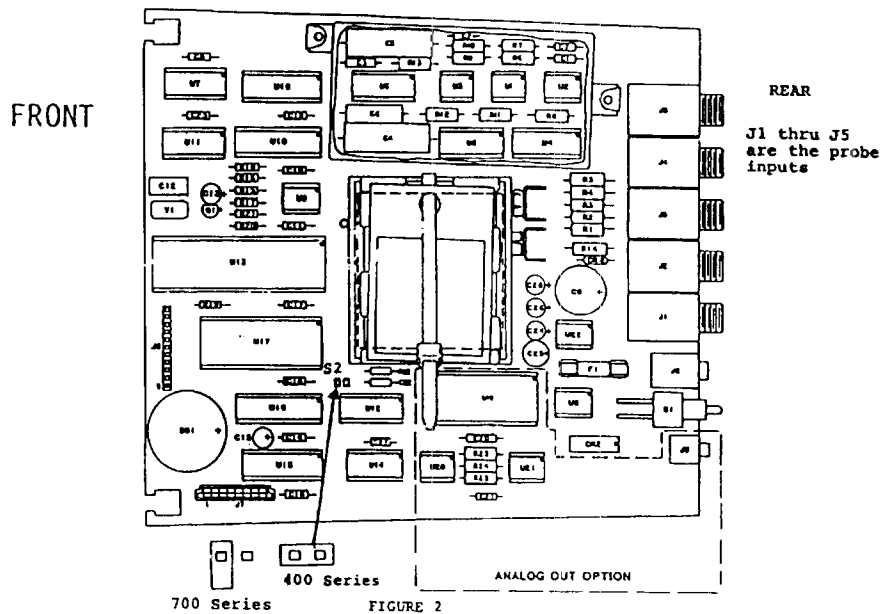

3. Put the jumper across the two pins for Series 400 (44004) probes or leave one pin open for Series 700 (44018) probes (44018 is the factory setting).
4. Replace the cover and secure the screws.

### 2.2.6 To attach a probe

- Insert the plug end of the probe into one of the five jacks on the rear panel. Up to five probes can be connected at once.
- When you attach the probes, push the plug all the way in so it is flush with the face of the rear panel. If you do not push the plug all the way in, the probe may not function properly.
- If the standard probe lead is not long enough for your purposes, you may extend the lead on each probe to the following limits:

WIRE SIZE	MAXIMUM LENGTH (feet)
24	100
22	150
23	250

## Section 3 OPERATION

You control the operation of your Model **5830/5831** through a front panel membrane key pad. Some general notes on using the keypad:

- The instrument cannot recognize multiple or simultaneous key strokes; press only one at a time.
- When you press any key, you will hear a soft beep of confirmation.
- When you select a probe, its corresponding front panel light will come on to indicate the probe is active.
- **DO NOT** use anything but your fingertip to press keys. Fingernails and other sharp objects (such as pens or pencils) can damage the keypad.

### 3.1 Displaying Thermistor Probe Readings

To measure and display one temperature, follow this procedure:

1. Plug appropriate thermistor probes into the jacks in the instrument's rear panel (the chart in Section 1.5, Probe Specifications and Characteristics, describes various kinds of probes and their recommended uses).
2. Install the probes as necessary in the areas to be measured.
3. Turn on the ON/OFF toggle switch on the rear panel of the instrument.
4. Press one of the probe number keys (1 through 5) to display the temperature reading for that probe.
5. The light below the selected key will come on, and the temperature reading will appear in the liquid-crystal display. The display for that probe will be updated four times every second until you turn the unit off or select another mode of operation.
6. To display the measurement from another probe, press the number key corresponding to that probe number.

### 3.2 Converting Between Fahrenheit and Centigrade

To switch temperature readings between Fahrenheit and Centigrade, press the **C/F** key in the upper right corner of the front panel. A **C** or an **F** as the last character in the display indicates the present temperature scale. The unit will use the present scale until you press **C/F** to change to the alternate scale.

### 3.3 Displaying Measurement Differences

To determine the difference in measurement between any two probes, follow this procedure:

1. Press the **DIFF** key.
2. Press the **ENTER** key. This puts the instrument in the setup mode.

The display will show the current **DIFF** setting, two probe numbers separated by a minus sign. The instrument is factory set to make the difference calculation for probe 1 minus probe 2. For a new instrument, this will be the displayed setup.

The displayed values will be retained unless you change them. If you leave the setup mode without making any changes, the previous parameters for **DIFF** remain unchanged.

3. Press the probe number keys to indicate which two probes you want to use in the calculation: the first key – the second key = **DIFF**.
4. Press **ENTER** again to leave the setup mode and begin measurements. If you leave the instrument in setup mode for more than 20 seconds without pressing a key, it automatically exits the setup mode and returns to its previous display.

While the unit is in DIFF mode, two probe lights will be illuminated to indicate that the instrument is displaying differences.

**NOTE:** The instrument can display negative numbers of four or fewer digits and positive numbers of five or fewer digits. If the difference to be displayed has more than the maximum number of digits, the instrument will display an error message. For example, if probe one reads 0 °C, and probe two reads 100 °C, the difference 1 – 2 is –100.00 °C. Since the unit cannot display a five-digit negative number, it displays the error message **UNFLO**, because the number is more negative than it can display.

### 3.4 Displaying Measurement Averages

To calculate and display the average of two or more probe measurements, follow this procedure:

1. Press the **AVG** key.
2. Press the **ENTER** key to enter the setup mode.

The display will show the current **AVG** setting; which is the number of each probe included in the average calculation. The instrument is factory set to make the average calculation for all 5 probes. For a new instrument, this will be the displayed setup.

The displayed values will be retained unless you change them. If you leave the setup mode without making any changes, the previous parameters for **AVG** remain unchanged.

3. Press the appropriate number keys to select probes to be averaged: the sum of the measurements of selected probes divided by the number of selected probes.
4. Press **ENTER** again to leave the setup mode and begin measurements and calculations. If you leave the instrument in the setup mode for more than 20 seconds without pressing a key, it automatically exits the setup mode and returns to its previous display.

While you are in the **AVG** mode, the **AVG** light and all selected probe lights will be illuminated.

### 3.5 Scanning Two or More Probe Measurements

To display two or more probe readings in a preset sequence:

1. Press the **SCAN** key.
2. Press the **ENTER** key to enter the setup mode.

The display will show the current **SCAN** setting, which is the number of each probe included in the scan sequence. The instrument is factory set to scan all 5 probes. For a new instrument, this will be the displayed setup. The displayed values will be retained unless you change them. If you leave the setup mode without making any changes, the previous parameters for **SCAN** remain unchanged.

3. Press the appropriate probe number keys to indicate which probes will be scanned and in what order.
4. Press **ENTER** again to leave the setup mode and begin measurements. If you leave the instrument in setup mode for longer than 20 seconds without pressing a key, it automatically exits the setup mode and returns to its previous display.

### 3.6 Displaying Maximum Temperature Reading

To display the maximum value read by a probe since the instrument was turned on (or since it was reset), press the **MAX** key.

The **MAX** value will appear for approximately three seconds before being replaced by the normal display. During this time all keys are inactive.

**MAX** display varies according to the display mode in effect when you press the key.

In **DIFF** mode – **MAX** displays the maximum difference.

In **AVG** mode – **MAX** displays the maximum average.

In **SCAN** mode – **MAX** displays the maximum reading of each probe in the scan sequence.

**NOTE:** If you switch to or from the **AVG** or **DIFF** modes, **MAX** will be reset automatically.

### 3.7 Displaying Minimum Temperature Reading

To display the minimum value read by a probe since the instrument was turned on (or since it was reset), press the **MIN** key.

The **MIN** value will appear for approximately three seconds before being replaced by the normal display. During this time all keys are inactive.

**MIN** display varies according to the display mode in effect when you press the key.

In **DIFF** mode – **MIN** displays the minimum difference.

In **AVG** mode – **MIN** displays the minimum average.

In **SCAN** mode – **MIN** displays the minimum reading of each probe in the scan sequence.

**NOTE:** If you switch to or from the **AVG** or **DIFF** modes, **MIN** will be reset automatically.

### 3.8 Resetting MAX and MIN

Use the **RESET** key to erase minimum and maximum values from instrument memory and start recording them again.

**RESET** only works when the **MAX** or **MIN** value is displayed. To reset **MAX** or **MIN**, press **MAX** or **MIN**, then while the value is displayed, press **RESET** once to erase the value of the displayed probe or twice to reset the value for all probes.

### 3.9 Freezing the Display

Use the **HOLD/RUN** key to freeze the display (lights on the front panel will blink when the **HOLD** mode is selected). When in the **HOLD** mode, the instrument continues to take measurements (and update **MAX** and **MIN**), but these values are not displayed. The optional analog output (if present) will continue to update. Press **HOLD/RUN** again to return the display to normal.

If the instrument is in the **SCAN** mode when you press **HOLD/RUN**, scanning will stop at the probe being scanned when you press **HOLD/RUN** and this probe's measurements will continue to be updated on the display. The light for the displayed probe will blink. Scanning resumes when you press **HOLD/RUN** a second time.

### 3.10 Switching from One Mode to Another

To leave one mode for another, press the key of the desired mode and follow the instructions in the corresponding section of this manual.

**NOTE:** If you switch to or from the **AVG** or **DIFF** modes, **MAX** and **MIN** will be reset automatically.



### 3.11 Using the Analog Output Option

With the Analog Output Option, you received a mating connector (see Figure 3) which plugs into the Analog Output jack in the rear panel of the instrument. Wire this connector to your output device.

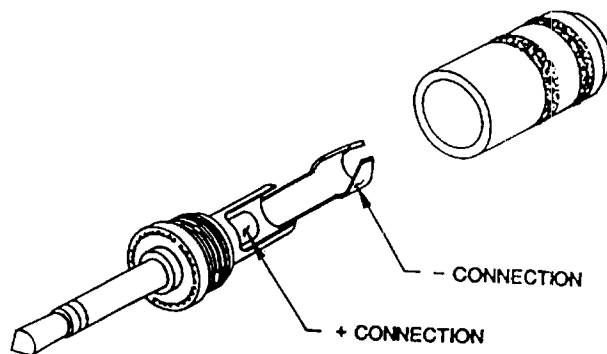

**Figure 3. The Analog Output Connector**

### 3.12 Prompts and Error Messages

MESSAGE	WHAT IT MEANS
oFlo	Overflow condition; trying to measure temperature higher than the upper range of the instrument; or trying to display a positive number with more digits than the instrument can display.
UnFlo	Underflow condition; trying to measure temperature lower than the lower range of the instrument; or trying to display a negative number with more digits than the instrument can display; or probe not installed.
Error	General error condition; you are doing something wrong, such as entering 3 probe numbers for a DIFF calculation, or 6 probe numbers for SCAN, etc.
Lo CAL	Low calibration; you are ready to plug in the low-resistance plugs for calibrating your unit.
HI CAL	High calibration; you are ready to plug in the high-resistance plugs for calibrating your unit.
Lo bA	Battery is getting too low, requiring recharging.

## Section 4 MAINTENANCE

Regularly scheduled inspection and proper care will maintain the accuracy and reliability that were designed into your Model 5830/31 thermometer.

### 4.1 Inspecting Your Model 5830/31

**Inspect the instrument regularly for any obvious faults:**

- Discoloration's
- Cracking or warping
- Loose, broken, or frayed wiring
- Dirty or pitted connector contacts
- Cracked or broken printed circuit boards
- Loose hardware mountings
- Loose electrical connections

### WARNING

Disconnect AC adapter from AC power source before performing internal inspections or repairs. Exposed connectors, electrical terminals, and components within the instrument may be connected to dangerous voltage potentials.

### 4.2 Calibrating Your Model 5830/31

If the thermometer is not giving accurate readings and the probe select jumper (see Section 2.3.1, Probe Selection) is in the proper position for the type of thermistor being used, the unit may require calibration. To calibrate the unit, you will need:

- Five resistors, 106.2K Ohm  $\pm 0.05\%$ ,  $\pm 10$  ppm 1/8 or 1/4 watt, each wired across a separate standard 1/4" phone plug.
- Five resistors, 407.1 Ohm  $\pm 0.05\%$ ,  $\pm 10$  ppm 1/8 or 1/4 watt, each wired across a separate standard 1/4" phone plug.

**Note:** The unit can be calibrated with the probe select jumper (see Section 2.3.1) set in either position; calibration is not affected by the jumper position.

### Procedure

1. Turn the unit off.
2. Press the probe number 1 key and continue to hold it down.
3. Turn on the power while pressing the 1 key.
4. When the display says USrCAL, release the key.

5. If you press the probe number 5 key, the display will say **HI CAL** and you can continue with the calibration with step 7 below.
6. If any other key besides 5 is pressed when the display says **USrCAL**, the unit will revert to the run mode. The operating mode will be whatever key was pressed that caused the unit to exit calibration mode.
7. Plug a 106.2K Ohm resistor into each of the probe jacks in the rear panel.
8. Press any probe number key and hold it in for three or four seconds. You will see the display message **LO CAL**.
9. Remove the 106.2K Ohm resistors. Plug in five 407.1-Ohm resistors.
10. Press any probe number key and hold it in for three or four seconds.

You have completed the calibration of your Model **5830/5831**. The instrument will default to the operating mode and the settings, which it was using before you last turned it off.

#### **4.3 Troubleshooting Your Model 5830/5831**

If the instrument operates but is inaccurate, calibrate before troubleshooting (see Section 4.2). If you cannot correct the problem by calibration, contact the Omega Engineering Customer Service Department at (203) 359-1660.

omega.com™

Ω OMEGA®

OMEGAnet □ On-Line Service

<http://www.omega.com>

Internet e-mail

[info@omega.com](mailto:info@omega.com)

**Servicing North America:**

**USA:**  
ISO 9001 Certified

One Omega Drive, Box 4047

Stamford, CT 06907-0047

Tel: (203) 359-1660

FAX: (203) 359-7700

E-mail: [canada@omega.com](mailto:canada@omega.com)

**Canada:**

976 Bergar

Laval (Quebec) H7L 5A1

Tel: (514) 856-6928

FAX: (514) 856-6886

E-mail: [canada@omega.com](mailto:canada@omega.com)

**For immediate technical or application assistance:**

**USA and Canada:**

Sales Service: 1-800-826-6342 / 1-800-TC-OMEGA □

Customer Service: 1-800-622-2378 / 1-800-622- BEST □

Engineering Service: 1-800-872-9436 / 1-800-USA-WHEN □

TELEX: 996404 EASYLINK: 62968934 CABLE: OMEGA □

**Mexico and**

**Latin America:**

Tel: (95) 800-TC-OMEGA □

FAX: (95) 203-359-7807

En Español: (203) 359-1660 ext.2203

E-mail: [espanol@omega.com](mailto:espanol@omega.com)

**Servicing Europe:**

**Benelux:**

Postbus 8034, 1180 LA Amstelveen, The Netherlands

Tel: (31) 20 6418405

FAX: (31) 20 6434643

Toll Free in Benelux: 06 0993344

E-mail: [nl@omega.com](mailto:nl@omega.com)

**Czech Republic:**

Ostravska 767,733 01 Karvina

Tel: 42 (69) 6311899

FAX: 42 (69) 6311114

E-mail: [czech@omega.com](mailto:czech@omega.com)

**France:**

9, rue Denis Papin, 78190 Trappes

Tel: (33) 130-621-400

FAX: (33) 130-699-120

Toll Free in France: 0800-4-06342

E-mail: [france@omega.com](mailto:france@omega.com)

**Germany / Austria:**

Daimlerstrasse 26, D-75392 Deckenpfronn, Germany

Tel: 49 (07056) 3017

FAX: 49 (07056) 8540

Toll Free in Germany: 0130 11 21 66

E-mail: [germany@omega.com](mailto:germany@omega.com)

**United Kingdom:**

ISO 9002 Certified

25 Swannington Road, P.O. Box 7, Omega Drive,

Broughton Astley, Leicestershire, Irlam, Manchester,

LE9 6TU, England M44 5EX, England

Tel: 44 (1455) 285520 Tel: 44 (161) 777-6611

FAX: 44 (1455) 283912 FAX: 44 (161) 777-6622

Toll Free in England: 0800-488-488

E-mail: [uk@omega.com](mailto:uk@omega.com)

It is the policy of OMEGA to comply with all worldwide safety and EMC/EMI regulations that apply.

Omega is constantly pursuing certification of its products to the European New Approach Directives.

OMEGA will add the CE mark to every appropriate device upon certification.

The information contained in this document is believed to be correct but OMEGA Engineering, Inc. accepts no liability for any errors it contains, and reserves the right to alter specifications without notice.

**WARNING:** These products are not designed for use in, and should not be used for patient connected applications.

# Where Do I Find Everything I Need for Process Measurement and Control? OMEGA . . . Of Course!

## TEMPERATURE

- Thermocouple, RTD & Thermistor Probes, Connectors, Panels & Assemblies
- Wire: Thermocouple, RTD & Thermistor
- Calibrators & Ice Point References
- Recorders, Controllers & Process Monitors
- Infrared Pyrometers

## PRESSURE, STRAIN AND FORCE

- Transducers & Strain Gauges
- Load Cells & Pressure Gauges
- Displacement Transducers
- Instrumentation & Accessories

## FLOW / LEVEL

- Rotameters, Gas Mass Flowmeters & Flow Computers
- Air Velocity Indicators
- Turbine / Paddlewheel Systems
- Totalizers & Batch Controllers

## pH/CONDUCTIVITY

- pH Electrodes, Testers & Accessories
- Benchtop/Laboratory Meters
- Controllers, Calibrators, Simulators & Pumps
- Industrial pH & Conductivity Equipment

## DATA ACQUISITION

- Data Acquisition & Engineering Software
- Communications-Based Acquisition Systems
- Plug-in Cards for Apple, IBM & Compatibles
- Datalogging Systems
- Recorders, Printers & Plotters

## HEATERS

- Heating Cable
- Cartridge & Strip Heaters
- Immersion & Band Heaters
- Flexible Heaters
- Laboratory Heaters

## ENVIRONMENTAL MONITORING AND CONTROL

- Metering & Control Instrumentation
- Refractometers
- Pumps & Tubing
- Air, Soil & Water Monitors
- Industrial Water & Wastewater Treatment
- pH, Conductivity & Dissolved Oxygen Instruments