

MADE IN
USA

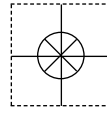

User's Guide



Shop on line at

omega.com™

ΩOMEGA®

www.omega.com

e-mail: info@omega.com

ISO 9001
CERTIFIED
CORPORATE QUALITY

STAMFORD, CT

ISO 9002
CERTIFIED
CORPORATE QUALITY

MANCHESTER, UK

PSW-100 SERIES Pressure Switches



OMEGAnet® On-Line Service www.omega.com	Internet e-mail info@omega.com
--	---

Servicing North America:

USA:
ISO 9001 Certified One Omega Drive, P.O. Box 4047
Stamford CT 06907-0047
TEL: (203) 359-1660 FAX: (203) 359-7700
e-mail: info@omega.com

Canada:
976 Bergar
Laval (Quebec) H7L 5A1
TEL: (514) 856-6928 FAX: (514) 856-6886
e-mail: info@omega.ca

For immediate technical or application assistance:

USA and Canada: Sales Service: 1-800-826-6342 / 1-800-TC-OMEGA®
Customer Service: 1-800-622-2378 / 1-800-622-BEST®
Engineering Service: 1-800-872-9436 / 1-800-USA-WHEN®
TELEX: 996404 EASYLINK: 62968934 CABLE: OMEGA

Mexico: En Español: (001) 203-359-7803 e-mail: espanol@omega.com
FAX: (001) 203-359-7807 info@omega.com.mx

Servicing Europe:

Benelux: Postbus 8034, 1180 LA Amstelveen, The Netherlands
TEL: +31 (0)20 6418405 FAX: +31 (0)20 6434643
Toll Free in Benelux: 0800 0993344
e-mail: nl@omega.com

Czech Republic: Rudé armády 1868, 733 01 Karviná 8
TEL: +420 (0)69 6311899 FAX: +420 (0)69 6311114
Toll Free: 0800-1-66342 e-mail: czech@omega.com

France: 9, rue Denis Papin, 78190 Trappes
TEL: +33 (0)130 621 400 FAX: +33 (0)130 699 120
Toll Free in France: 0800-4-06342
e-mail: france@omega.com

Germany/Austria: Daimlerstrasse 26, D-75392 Deckenpfronn, Germany
TEL: +49 (0)7059 9398-0 FAX: +49 (0)7056 9398-29
Toll Free in Germany: 0800 639 7678
e-mail: germany@omega.com

United Kingdom: One Omega Drive, River Bend Technology Centre
ISO 9002 Certified Northbank, Irlam, Manchester
M44 5EX United Kingdom
TEL: +44 (0)161 777 6611 FAX: +44 (0)161 777 6622
Toll Free in United Kingdom: 0800-488-488
e-mail: sales@omega.co.uk

It is the policy of OMEGA to comply with all worldwide safety and EMC/EMI regulations that apply. OMEGA is constantly pursuing certification of its products to the European New Approach Directives. OMEGA will add the CE mark to every appropriate device upon certification.

The information contained in this document is believed to be correct, but OMEGA Engineering, Inc. accepts no liability for any errors it contains, and reserves the right to alter specifications without notice.

WARNING: These products are not designed for use in, and should not be used for, patient-connected applications.

Pressure Switch

Part Numbers:

PSW-104, 105, 107-118, 120-125, 127-133, 135-139

Please read all instructional literature carefully and thoroughly before starting.

GENERAL

The PSW-104, 105, 107-118, 120-125, 127-133, 135-139 pressure switches are activated when bellows, diaphragm or piston sensor responds to a pressure change. This response, at a pre-determined set point, actuates a single snap-acting switch, converting the pressure signal into an electrical signal. Control set point may be varied by turning the internal adjustment hex. (See Adjustment -PART II).

Part I - Installation

Tools Needed

Adjustable Wrench

Screwdriver

Hammer (for alternate wire knockouts)

MOUNTING

 INSTALL UNIT WHERE SHOCK, VIBRATION AND TEMPERATURE FLUCTUATIONS ARE MINIMAL. ORIENT UNIT SO THAT MOISTURE IS PREVENTED FROM ENTERING THE ENCLOSURE. IF UNIT IS BEING INSTALLED WHERE HEAVY CONDENSATION IS EXPECTED, VERTICAL MOUNTING (PRESSURE CONNECTION DOWN) IS REQUIRED. DO NOT MOUNT IN AMBIENT TEMPERATURES EXCEEDING PUBLISHED LIMITS.

Controls may be mounted and operated in any position. They may be surface mounted via the two mounting ears on either side of the enclosure, or directly to a rigid pipe by using the pressure connection. Should the control be installed where condensation is expected, vertical mounting is recommended as a means of keeping water away from switch terminals.

Never use the enclosure for leverage to hand tighten the pressure connection. Always use a wrench to tighten the pressure connection to the pipe. To prevent damaging the pressure sensor, use a back-up wrench to hold the hex nut in place when surface mounting.

On models supplied with an external manual reset button, be sure to leave sufficient finger space over the reset button for the operator to reset the control.

WIRING



DISCONNECT ALL SUPPLY CIRCUITS BEFORE WIRING.



ELECTRICAL RATINGS STATED IN LITERATURE AND ON NAMEPLATES SHOULD NEVER BE EXCEEDED. OVERLOAD ON A SWITCH CAN CAUSE FAILURE ON THE FIRST CYCLE.



WIRE UNITS ACCORDING TO NATIONAL AND LOCAL ELECTRICAL CODES. MAXIMUM RECOMMENDED WIRE SIZE IS 14 AWG.

Remove the two screws retaining the cover and cover gasket. Two cast-in knockouts for 1/2" conduit are located on the side and back of enclosure. These can easily be knocked out by placing the blade of a screwdriver in the groove and rapping sharply with a hammer. A 1/2" NPT conduit connection is also provided on the left hand side of the enclosure. The three switch terminals are clearly labeled "common", "normally open" and "normally closed". For switches supplied with leadwires, the following color coding applies:

Grounding screw and clamp (cast in symbol) is provided. Keep the wire as short as possible to prevent interface with the plunger and the adjustable differential switch wheel, if applicable.

Manual Reset SPDT	
Common	Violet
Normally Open	Blue
Normally Closed	Black

Part II - Adjustments

Tools Needed

5/8" Open End Wrench

 SOME MODELS HAVE A TWO-PIECE, ADJUSTABLE PLUNGER. THIS FEATURE IS CHARACTERIZED BY A 3/16" HEX HEAD SCREW INSTALLED IN THE 1/4" HEX PLUNGER. THE LENGTH OF THIS ASSEMBLY IS ADJUSTED AT OUR FACTORY AND IS CRITICAL TO THE FUNCTION OF THE CONTROL.

 DURING NORMAL CALIBRATION, THIS ADJUSTMENT SHOULD NOT BE DISTURBED. HOWEVER, WHEN REPLACING THE ELECTRICAL SWITCH, IT MAY BE NECESSARY TO ADJUST THE PLUNGER LENGTH IN ORDER TO "RE-GAP" THE SWITCH. REFER TO INSTRUCTIONS IN "PART III-REPLACEMENTS" TO DETERMINE IF REGAPPING IS NECESSARY.

For set point adjustments and recalibration, connect control to a calibrated pressure source.

PSW-100, 130

Remove pressure switch cover. Adjust set point by turning 5/8" hex adjustment screw clockwise (in) to raise set point, or counter clockwise (out) to lower set point. Tension on adjustment screw can be increased by tightening adjustment lock onto it. Controls include uncalibrated reference scales for high, low or mid range settings.

3. Insert insulator and replacement switch. Orient switch plunger over the adjustment screw; tighten switch mounting screws securely.

Gapping

Turn 5/8" hex adjustment screw in approximately mid range. This puts a load on the plunger sensor. Using a 1/4" wrench on the plunger and a 3/16" wrench on the plunger hex screw, turn hex screw out from plunger until switch actuates. (If switch is already actuated proceed to the next step.) Turn plunger hex screws in, until switch just transfers. Turn hex screw in a additional 2 - 2 1/2 flats from this point (approximately 1/3 turn). This will provide a 9-11 Mil gap. Follow set point adjustment procedure.

4. Check set point according to PART II.

5. Connect wires and replace cover securely.

Part III - Replacements

Tools Needed

Screwdriver
Adjustable Wrench

 USE ONLY FACTORY AUTHORIZED REPLACEMENT PARTS AND PROCEDURES. COMPONENTS AVAILABLE FOR REPLACEMENT ARE THE SWITCHES. OTHER COMPONENTS FACTORY REPLACEABLE ONLY. DISCONNECT LIVE CIRCUITS BEFORE REPLACING THE SWITCH.

Switch Replacement (all models)

1. Disconnect lead wires from the terminals.
2. Remove switch mounting screws (2) and take out the switch and insulator.

Dimensions

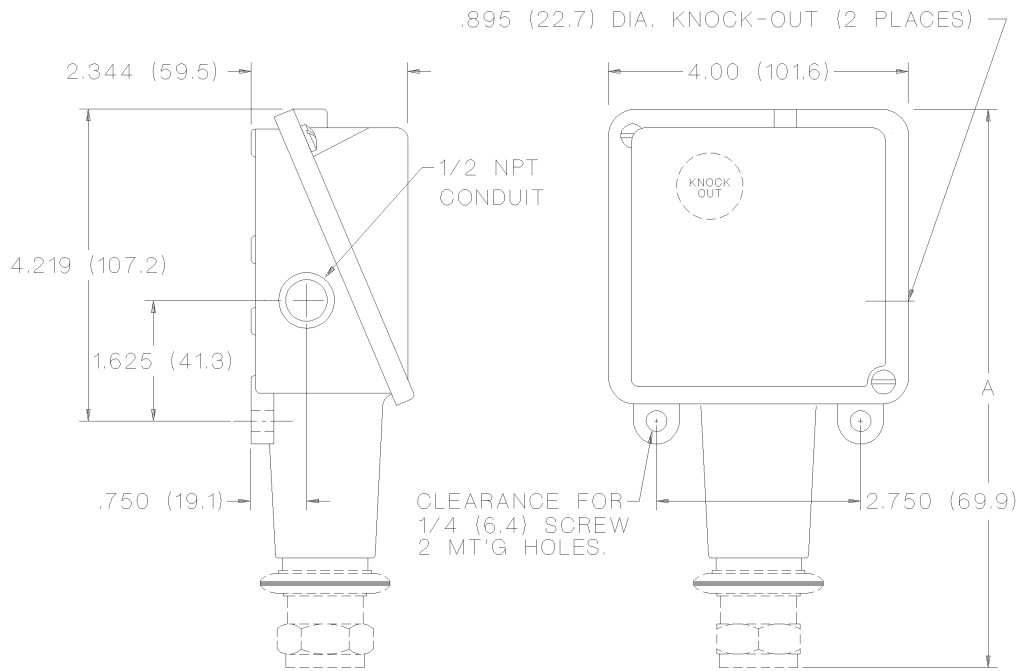

Dimension A

Model	Inches	mm	NPT
PSW-104, 105	7.50	190.57	1/2
PSW-107-117	6.25	166.67	1/4
PSW-118-125	6.63	168.27	1/2
PSW-127-129	6.56	166.67	1/4
PSW-130-131	7.03	176.99	1/4
PSW-132	6.97	177.04	1/4
PSW-133	7.00	177.80	1/4
PSW-134-139	8.44	214.30	1/2

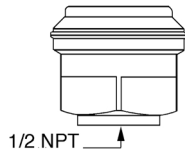

PSW-104, 105

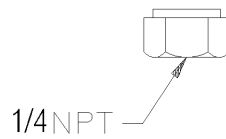

PSW-107 - 117, 127 - 129, 130 - 133

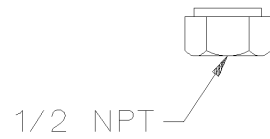

PSW-118 - 125

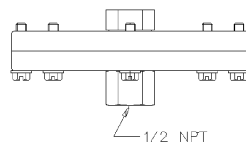

PSW-134 - 139



WARRANTY/DISCLAIMER

OMEGA ENGINEERING, INC. warrants this unit to be free of defects in materials and workmanship for a period of **13 months** from date of purchase. OMEGA's WARRANTY adds an additional one (1) month grace period to the normal **one (1) year product warranty** to cover handling and shipping time. This ensures that OMEGA's customers receive maximum coverage on each product.

If the unit malfunctions, it must be returned to the factory for evaluation. OMEGA's Customer Service Department will issue an Authorized Return (AR) number immediately upon phone or written request. Upon examination by OMEGA, if the unit is found to be defective, it will be repaired or replaced at no charge. OMEGA's WARRANTY does not apply to defects resulting from any action of the purchaser, including but not limited to mishandling, improper interfacing, operation outside of design limits, improper repair, or unauthorized modification. This WARRANTY is VOID if the unit shows evidence of having been tampered with or shows evidence of having been damaged as a result of excessive corrosion; or current, heat, moisture or vibration; improper specification; misapplication; misuse or other operating conditions outside of OMEGA's control. Components which wear are not warranted, including but not limited to contact points, fuses, and triacs.

OMEGA is pleased to offer suggestions on the use of its various products. However, OMEGA neither assumes responsibility for any omissions or errors nor assumes liability for any damages that result from the use of its products in accordance with information provided by OMEGA, either verbal or written. OMEGA warrants only that the parts manufactured by it will be as specified and free of defects. OMEGA MAKES NO OTHER WARRANTIES OR REPRESENTATIONS OF ANY KIND WHATSOEVER, EXPRESS OR IMPLIED, EXCEPT THAT OF TITLE, AND ALL IMPLIED WARRANTIES INCLUDING ANY WARRANTY OF MERCHANTABILITY AND FITNESS FOR A PARTICULAR PURPOSE ARE HEREBY DISCLAIMED. LIMITATION OF LIABILITY: The remedies of purchaser set forth herein are exclusive, and the total liability of OMEGA with respect to this order, whether based on contract, warranty, negligence, indemnification, strict liability or otherwise, shall not exceed the purchase price of the component upon which liability is based. In no event shall OMEGA be liable for consequential, incidental or special damages.

CONDITIONS: Equipment sold by OMEGA is not intended to be used, nor shall it be used: (1) as a "Basic Component" under 10 CFR 21 (NRC), used in or with any nuclear installation or activity; or (2) in medical applications or used on humans. Should any Product(s) be used in or with any nuclear installation or activity, medical application, used on humans, or misused in any way, OMEGA assumes no responsibility as set forth in our basic WARRANTY/DISCLAIMER language, and, additionally, purchaser will indemnify OMEGA and hold OMEGA harmless from any liability or damage whatsoever arising out of the use of the Product(s) in such a manner.

RETURN REQUESTS/INQUIRIES

Direct all warranty and repair requests/inquiries to the OMEGA Customer Service Department. BEFORE RETURNING ANY PRODUCT(S) TO OMEGA, PURCHASER MUST OBTAIN AN AUTHORIZED RETURN (AR) NUMBER FROM OMEGA'S CUSTOMER SERVICE DEPARTMENT (IN ORDER TO AVOID PROCESSING DELAYS). The assigned AR number should then be marked on the outside of the return package and on any correspondence.

The purchaser is responsible for shipping charges, freight, insurance and proper packaging to prevent breakage in transit.

FOR **WARRANTY** RETURNS, please have the following information available BEFORE contacting OMEGA:

1. Purchase Order number under which the product was PURCHASED,
2. Model and serial number of the product under warranty, and
3. Repair instructions and/or specific problems relative to the product.

FOR **NON-WARRANTY** REPAIRS, consult OMEGA for current repair charges. Have the following information available BEFORE contacting OMEGA:

1. Purchase Order number to cover the COST of the repair,
2. Model and serial number of the product, and
3. Repair instructions and/or specific problems relative to the product.

OMEGA's policy is to make running changes, not model changes, whenever an improvement is possible. This affords our customers the latest in technology and engineering.

OMEGA is a registered trademark of OMEGA ENGINEERING, INC.

© Copyright 2000 OMEGA ENGINEERING, INC. All rights reserved. This document may not be copied, photocopied, reproduced, translated, or reduced to any electronic medium or machine-readable form, in whole or in part, without the prior written consent of OMEGA ENGINEERING, INC.

Where Do I Find Everything I Need for Process Measurement and Control? **OMEGA...Of Course!**

Shop on line at www.omega.com

TEMPERATURE

- ☑ Thermocouple, RTD & Thermistor Probes, Connectors, Panels & Assemblies
- ☑ Wire: Thermocouple, RTD & Thermistor
- ☑ Calibrators & Ice Point References
- ☑ Recorders, Controllers & Process Monitors
- ☑ Infrared Pyrometers

PRESSURE, STRAIN AND FORCE

- ☑ Transducers & Strain Gages
- ☑ Load Cells & Pressure Gages
- ☑ Displacement Transducers
- ☑ Instrumentation & Accessories

FLOW/LEVEL

- ☑ Rotameters, Gas Mass Flowmeters & Flow Computers
- ☑ Air Velocity Indicators
- ☑ Turbine/Paddlewheel Systems
- ☑ Totalizers & Batch Controllers

pH/CONDUCTIVITY

- ☑ pH Electrodes, Testers & Accessories
- ☑ Benchtop/Laboratory Meters
- ☑ Controllers, Calibrators, Simulators & Pumps
- ☑ Industrial pH & Conductivity Equipment

DATA ACQUISITION

- ☑ Data Acquisition & Engineering Software
- ☑ Communications-Based Acquisition Systems
- ☑ Plug-in Cards for Apple, IBM & Compatibles
- ☑ Datalogging Systems
- ☑ Recorders, Printers & Plotters

HEATERS

- ☑ Heating Cable
- ☑ Cartridge & Strip Heaters
- ☑ Immersion & Band Heaters
- ☑ Flexible Heaters
- ☑ Laboratory Heaters

ENVIRONMENTAL MONITORING AND CONTROL

- ☑ Metering & Control Instrumentation
- ☑ Refractometers
- ☑ Pumps & Tubing
- ☑ Air, Soil & Water Monitors
- ☑ Industrial Water & Wastewater Treatment
- ☑ pH, Conductivity & Dissolved Oxygen Instruments