

1 YEAR
WARRANTY

MADE IN
USA

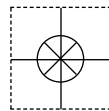

User's Guide

Shop on line at

omega.com™

Ω OMEGA™

www.omega.com

e-mail: info@omega.com



CL900A/CL950A SERIES **hot point® Dry Block** **Probe Calibrator**



OMEGAnet® Online Service
www.omega.com

Internet e-mail
info@omega.com

Servicing North America:

USA:
ISO 9001 Certified

One Omega Drive, P.O. Box 4047
Stamford CT 06907-0047
TEL: (203) 359-1660 FAX: (203) 359-7700
e-mail: info@omega.com

Canada:

976 Bergar
Laval (Quebec) H7L 5A1, Canada
TEL: (514) 856-6928 FAX: (514) 856-6886
e-mail: info@omega.ca

For immediate technical or application assistance:

USA and Canada: Sales Service: 1-800-826-6342 / 1-800-TC-OMEGA™
Customer Service: 1-800-622-2378 / 1-800-622-BEST®
Engineering Service: 1-800-872-9436 / 1-800-USA-WHEN®
TELEX: 996404 EASYLINK: 62968934 CABLE: OMEGA

Mexico:

En Español: (001) 203-359-7803 e-mail: espanol@omega.com
FAX: (001) 203-359-7807 info@omega.com.mx

Servicing Europe:

Benelux:

Postbus 8034, 1180 LA Amstelveen, The Netherlands
TEL: +31 (0)20 3472121 FAX: +31 (0)20 6434643
Toll Free in Benelux: 0800 0993344
e-mail: sales@omegaeng.nl

Czech Republic:

Frystatska 184, 733 01 Karviná, Czech Republic
TEL: +420 (0)59 6311899 FAX: +420 (0)59 6311114
Toll Free: 0800-1-66342 e-mail: info@omegashop.cz

France:

11, rue Jacques Cartier, 78280 Guyancourt, France
TEL: +33 (0)1 61 37 2900 FAX: +33 (0)1 30 57 5427
Toll Free in France: 0800 466 342
e-mail: sales@omega.fr

Germany/Austria:

Daimlerstrasse 26, D-75392 Deckenpfronn, Germany
TEL: +49 (0)7056 9398-0 FAX: +49 (0)7056 9398-29
Toll Free in Germany: 0800 639 7678
e-mail: info@omega.de

United Kingdom:

ISO 9002 Certified

One Omega Drive, River Bend Technology Centre
Northbank, Irlam, Manchester
M44 5BD United Kingdom
TEL: +44 (0)161 777 6611 FAX: +44 (0)161 777 6622
Toll Free in United Kingdom: 0800-488-488
e-mail: sales@omega.co.uk

It is the policy of OMEGA to comply with all worldwide safety and EMC/EMI regulations that apply.

The information contained in this document is believed to be correct, but OMEGA Engineering, Inc. accepts no liability for any errors it contains, and reserves the right to alter specifications without notice.

WARNING: These products are not designed for use in, and should not be used for, human applications.

Table of Contents

Section	Page
Section 1 Introduction	1-1
1.1 Precautions	1-1
1.2 Safety Warnings and IEC Symbols	1-1
1.3 General Description	1-2
Section 2 Installation	2-1
2.1 Unpacking and Inspection	2-1
2.2 Mounting	2-2
2.3 Ambient Temperature	2-2
2.4 Power Connection	2-2
Section 3 Operation	3-1
3.1 Front Panel Controls and Indicators	3-1
3.2 Back Panel Connections	3-3
3.3 Changing the Temperature Setpoint	3-4
3.4 Changing the Controller Parameters	3-4
3.5 Target Plate Temperature Transition Chart	3-5
3.6 Replacing Probe Well Inserts in the CL900A	3-5
3.7 Fanning System	3-6
3.8 Overhead Reset Switch	3-7
Section 4 Maintenance	4-1
4.1 Calibration	4-1
4.2 Cleaning	4-1
4.2.1 Main Body	4-1
4.2.2 Target Plate	4-1
4.2.3 Fan and Vent Guards	4-1
4.3 Fuse Replacement	4-1
Section 5 RC232 Communications	5-1
Section 6 Specifications	6-1
Section 7 Troubleshooting Guide	7-1
Section 8 Glossary of Terms Used in This Manual	8-1
Section 9 The OMEGA™ Family of Blackbody Calibrators	9-1

Table of Figures

Figure Description:	Page:
1. IEC Symbols	1-1
2. Probe Well Inserts for the CL900A	1-2
3. CL900A Probe Well.....	2-1
4. CL950A Probe Well	2-1
5. CL950A-230 Probe Well	2-1
6. Front Panel	3-1
7. Back Panel	3-3
8. Controller Menu Hierarchy Showing Factory Default Parameters Settings	3-4
9. Approximate Target Plate Temperature Transition Times Chart	3-5
10. Removal of Probe Well Insert in CL900A	3-6
11. Connecting the CL900A to a Computer's Serial Port	4-3

Section 1 - Introduction

Your CL900A/CL950A hot point™ Thermocouple, RTD and thermistor Probe Calibrators have been designed for ease of use and reliability whenever you have the need to test or calibrate temperature probes. It is important that you read this manual completely and follow all safety precautions before operating this instrument.

1.1 Precautions

- Follow all safety precautions and operating instructions outlined in this manual.
- Never leave your calibrator unattended when in use.
- Keep out of reach of children.
- Never touch the probe well area when hot.
- Never place any object within 3 inches of the probe well opening when hot.
- Do not operate in flammable or explosive environments.
- Never operate with a power cord other than the one provided with your unit.
- Remove and or disconnect main power cord before attempting any maintenance or fuse replacement.
- Do not connect and or operate this unit to a non-grounded, non-polarized outlet or power source.
- Do not connect the serial port or reference probe port to equipment with exposed, hazardous, live voltages.

NOTE

There are no user serviceable parts inside your unit. Attempting to repair or service your unit may void your warranty.

1.2 Safety Warnings and IEC Symbols

This device is marked with international safety and hazard symbols in accordance with IEC 1010. It is important to read and follow all precautions and instructions in this manual before operating or commissioning this device as it contains important information relating to safety and EMC. Failure to follow all safety precautions may result in injury and or damage to your calibrator. Use of this device in a manner not specified by the manufacturer may impair protection provided within the unit.

IEC symbols

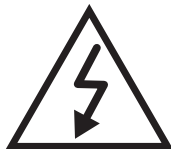

Description

Caution, risk of electric shock



Caution, refer to accompanying documents



Caution, hot surface



230 VAC @50Hz (European Models)
115 VAC @60Hz (Domestic Models)

Figure 1. IEC symbols

1.3 General Description

The CL900A and CL950A are a part of a family of calibrators which allows for calibration of thermocouples, thermistors, RTD and thermistor probes quickly and easily with an accuracy to 0.8°C (1.5°F).

An integral RTD sensor assures high measurement accuracy and repeatability. A built-in microprocessor-based PID digital controller assures exceptional stability. Setpoint and actual temperature are displayed, simultaneously. Temperature can be set in one degree increments from 22°C (40°F) above ambient temperature to 482°C (900°F).

The CL900A differs from the CL950A only with regard to the probe well. The CL900A has a removable, single-port well insert. The CL950A has a built-in multipoint well. The CL900A is shipped with the CL906 insert (diameter=1/4", depth=6"). The CL900A-230 is shipped with the CL906-M insert (diameter=4.5 mm, depth= 152.4 mm).

Probe Well Inserts with "Inch Sizes"			Probe Well Inserts with "Metric Sizes"		
OMEGA Part No.	Probe Hole Diameter	Probe Hole Depth	OMEGA Part No.	Probe Hole Diameter	Diameter Hole Depth
CL901	1/8"	4"	CL901-M	2 mm	106.6 mm
CL902	1/8"	6"	CL902-M	2 mm	152.4 mm
CL903	3/16"	4"	CL903-M	3 mm	106.6 mm
CL904	3/16"	6"	CL904-M	3 mm	152.4 mm
CL905	1/4"	4"	CL905-M	4.5 mm	106.6 mm
CL906	1/4"	6"	CL906-M	4.5 mm	152.4 mm
CL907	5/16"	4"	CL907-M	6 mm	106.6 mm
CL908	5/16"	6"	CL908-M	6 mm	152.4 mm
CL909	3/8"	4"	-	-	-
CL910	3/8"	6"	-	-	-
CL911	UNDRILLED	6" Max.	-	-	-

Figure 2. Probe Well Inserts for the CL900A

As shown in Figure 1, various inserts may be ordered from OMEGA to meet your specific probe requirements. The insert slides into the probe well of the CL900A.

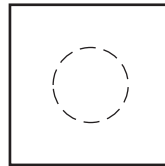

Figure 3. CL900A Probe Well

The CL950A and CL950A-230 have permanently fixed multi-port wells that accept 4 different probe sizes. The CL950A and CL950A-230 has 4 standard inch holes with diameters: 1/16", 1/4"x 2, 1/8", 3/16" with 6" hole depth. The CL950A-M and CL950A-M-230 has 4 standard metric holes with diameters: 2 mm, 3 mm, 4.5 mm, and 6 mm x 2 with 152.4 mm hole depth.

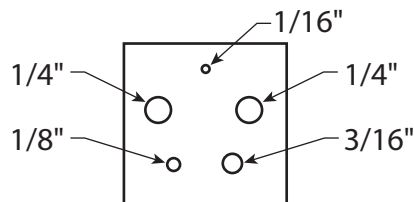

Figure 4. CL950A Probe Well

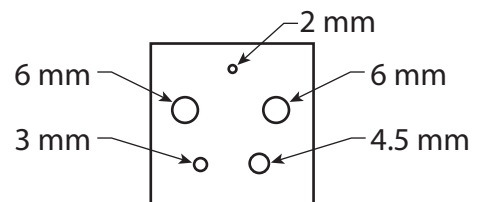

Figure 5. CL950A-M Probe Well

NOTES:

Section 2 - Installation

2.1 Unpacking

Remove the packing list and verify that you have received all your equipment. If you have any questions about the shipment, please call our Customer Service Department at

1-800-622-2378 or 203-359-1660

website: <http://www.omega.com>

e-mail: info@omega.com

When you receive the shipment, inspect the container and equipment for any signs of damage. Note any evidence of rough handling in transit. Immediately report any damage to the shipping agent.

NOTE:

The carrier will not honor any damage claims unless all shipping material is saved for inspection. After examining and removing contents, save packing material and carton in the event reshipment is necessary.

The following items are supplied in the box: The following items are supplied in the box:

Item:	OMEGA Part #:
Hotpoint Calibrator(Removable single port well insert)	CL900A /CL900-230
Or	Or
Hotpoint Calibrator (Built-in multiport well)	CL950A /CL950-230
Probe Well Insert for 1/4" Probes (shipped with CL900A)*	CL906
Or	Or
Probe Well Insert for 4.5 MM Probes (shipped with CL900A-230) *	CL906-M
User Manual	M-3555
Calibration Certificate	CAL-3
Power Cord	200-0028 (Domestic), 200-0107 (International)
Well Insert Removal Tool	HP-0037 (CL900A only)

*A probe well insert is only included with Model CL900A or CL900A-230.

2.2 Mounting

Mount the unit on a bench, table top or shelf in a horizontal position and operate at least ten inches from any air obstructions to the fan, front panel, rear panel, bottom and top of the unit, in an ambient environment between the specified 5°C to 38°C (40°F to 100°F).

2.3 Ambient Temperature

The CL900A/CL950A is designed to operate within an ambient temperature range from 5°C to 38°C (40°F to 100°F). Failure to operate the unit within this range may damage your unit. If the unit is operated in an ambient temperature above 38°C (100°F) a thermal cutoff switch will cut off power to the heater. The process variable (PV) will no longer approach the setpoint variable (SV). The heaters will cool down and cease to operate. If this should occur you should send your unit back to OMEGA for service.

2.4 Power Connection

Standard (115 VAC~, 50/60 Hz models)

The CL900A/CL950A comes with a standard North American 3-prong AC power cord. Do not use any other power cord other than the one provided. This cord is of adequate wire gage, grounding features and has been safety tested by the proper safety agencies.

International (230 VAC~, 50/60 Hz models)

On CL900A-230/CL950A-230 models an International style power cord with the proper color code and approvals is provided with stripped wire ends for connection to the proper connector used in your country or local area. The connector is not provided.

NOTE:

- Electrical connections and wiring should be performed only by suitably trained personnel.
 - Be sure that the line voltage powering your unit does not go above or below 10% of the rated voltages specified above.
-

Section 3 - Operation

3.1 Front Panel Controls and Indicators

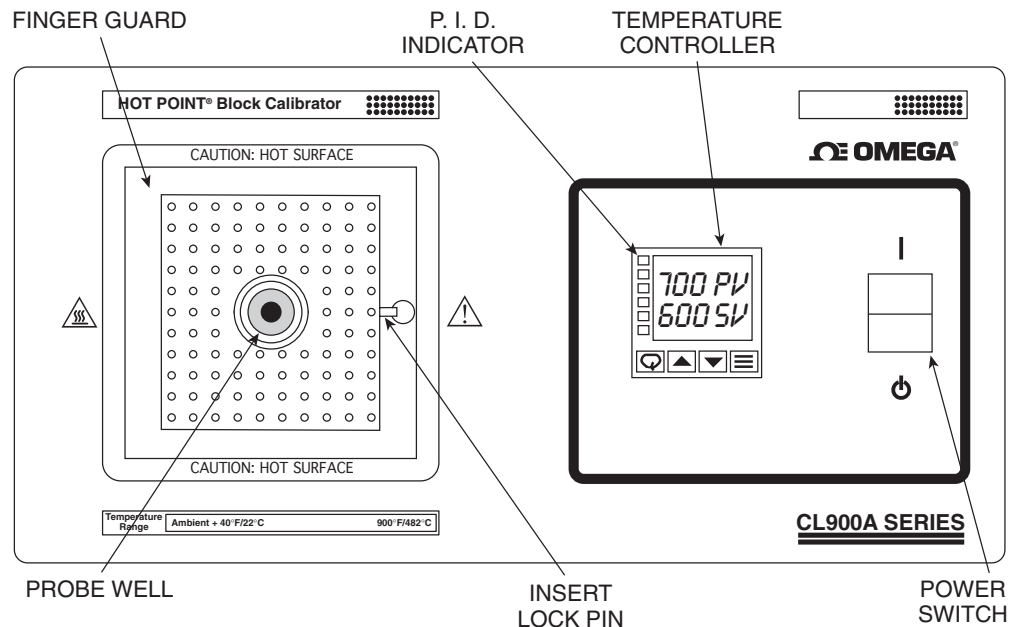

Figure 6. Front Panel

Temperature Controller:

The temperature controller provides a separate digital display for setpoint temperature as well as process temperature. Buttons are provided on the front panel for configuring the controller. The CL900A/CL950A is shipped pre-configured. The customer should not alter any parameters except for the displayed engineering units ($^{\circ}\text{F}/^{\circ}\text{C}$).

P.I.D. Indicator:

When this light is illuminated, the unit is heating up the target plate.

NOTE:

P.I.D. Control:

Proportional, integral, derivative control (P.I.D.) is a temperature control algorithm used in high-end temperature controllers. The controller causes the process to attain the desired temperature by turning the process on or off. The process may be a heater or refrigerator. As the process temperature approaches the setpoint temperature the hot or cold process will be pulsed to reduce the corrective measures and minimize overshooting. The controller provides a visual representation of the process status through LED indicators. An indicator may be lit continuously, blink or shut off entirely to indicate that the process is on, being pulsed, or off, respectively.

Probe Well:

The CL900A allows for different probe well insert options, whereas the CL950A comes with a fixed probe well which accepts 4 different probe diameters. The probe well in both units is chassis grounded. **It is critical that a power outlet with a grounding lug be used. Never defeat the grounding conductor in any way.**

**Menu Access Key:**

Hold down for 3 seconds, initially, to access the programming mode. Once in the programming mode, momentarily press this key to scroll through the menus.

**Raise Key:**

Momentarily press to increase the selected parameter or scroll upward in the list of possible settings.

**Lower Key:**

Momentarily press to decrease the selected parameter or scroll downward in the list of possible settings.

**Mode/Enter Key:**

Hold down for 3 seconds to enter the standby setup mode, initially. Once in the program mode, viewing a parameter, use this key to save the current setting and advance to the next parameter.

3.2 Back Panel Connections

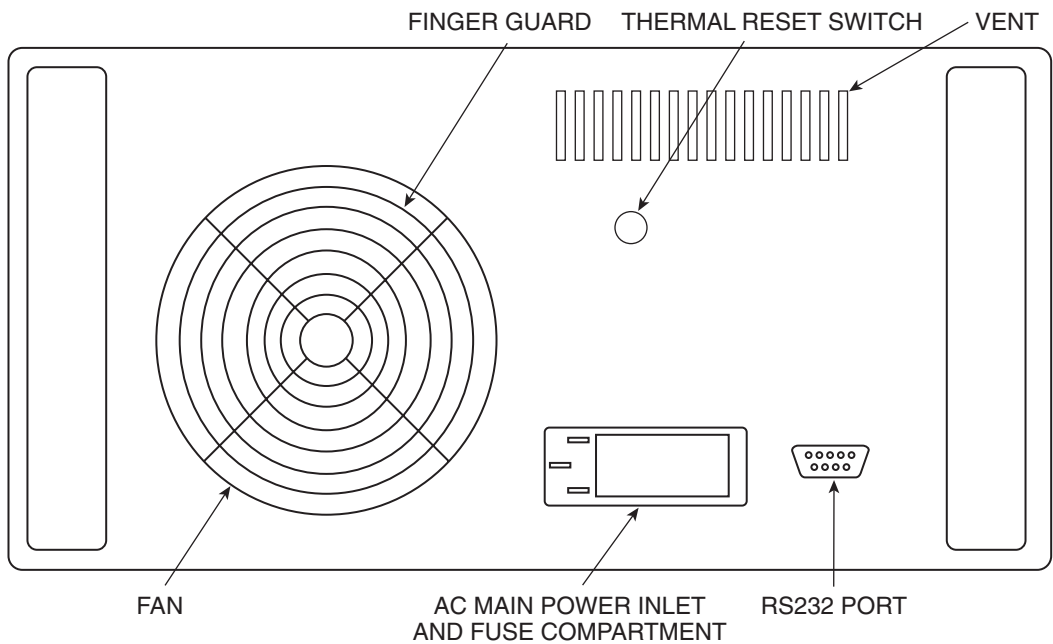

Figure 7. Back Panel

AC Power Input:

The customer connects the power cord to the AC Power Input. Refer to Section 4.3 for information on fuse replacement.

Power Switch

The power switch has two positions, "ON" and "STANDBY."

Power Switch

The power switch has two positions, "ON" and "STANDBY."



In the "ON" mode, the entire unit is powered up. The fan will turn on immediately when entering the "ON" mode. Once the calibrator is no longer being used and the switch is placed in the "STANDBY" mode, the unit is powered down except for the fan circuit. The fan will continue to run for two hours.

WARNING

Do not disconnect the power cord from the unit while the unit is cooling down. Do not disconnect the power cord until the unit has completed its cool down period. Never transport the unit while it is still hot.

3.3 Changing the Temperature Setpoint

The layout of the front panel is shown in Figure 2. The CL900A/CCL950A incorporates a PID digital setpoint controller. The setpoint variable (SV) is changed by holding in either the ▲ key or the ▼ key. The setpoint variable will change at 3 different rates depending on how long a key is being pressed. The minimum setpoint is 38°C (100°F), the maximum setpoint 482.2°C (900°F).

3.4 Changing the Controller Parameter Settings

The CL900A/CL950A operates at its optimum performance when left with the factory parameter settings. The only internal parameter that the operator may need to change is the engineering units (°F or °C). Below are two diagrams: a) menu hierarchy with factory default settings b) programming procedure. In the event that some parameters have accidentally been changed, use the factory default settings shown below.

NOTE:

Changing any other parameter settings besides the engineering units will decrease the accuracy of your calibrator.







Menu 00	Menu 01	Menu 02	Menu 03	Menu 04	Menu 05
Key Lock	SETPOINT Ac.Cd	Ac.Cd = 02	Ac.Cd = 03	Ac.Cd = 04	Ac.Cd = 05
		Gn.o1 113	ALr1 925	id.no 01	SnSr P
		Gr.o2	ALr2	bAUd 12.o.7	Sn.00
		rAtE 24	Cy.t1 01	CAL.L	dEC.P
		rSEt 122	Cy.t2	CAL.H	FILt
		H.Hys	SP.tt OFF		OUt.1 Ht.P
		HyS.1	L.SP.L 80		OUt.2 Air
		C.HyS	L.SCL		CoL.t nor
		HyS.2	U.SP.L 900		A1.HL HI
		C.SPr	H.SCL		A1.Pd Pr
		SPr.2			A1.OP LAt
		dPnG NI			A2.HL HI
					A2.Pd Pr
					A2.OP OFF
					Unit F

Figure 8. Controller Menu Hierarchy Showing Factory Default Parameter Settings

WARNING:

Do not re-program the controller's parameter settings or change the wiring inside your unit to override the maximum setpoint value of 482.2°C (900°F).

Changing the controller's parameter settings:

1. Press the  key to enter the programming mode. The lower display will alternately display the menu level and "Ac.Cd."
2. Use the  and  keys to change to the desired menu level.
3. Once you have chosen the desired menu use the  key to scroll through the parameters. To change the setting of a given parameter, use the  and  keys.
4. To save settings press the  key. The controller now exits the programming menu and return to the normal operating mode.
5. To change settings on other menu levels, you must re-enter the programming menu (from step #1).

3.5 Approximate Target Plate Temperature Transition Chart

FROM:\nTO:	100°F	500°F	900°F
100°F	X	9 min.	21 min.
500°F	108 min.	X	15 min.
900°F	132 min.	25 min.	X

Figure 9. Approximate Target Plate Temperature Transition Times

The CL900A/CL950A heat-up and cool-down characteristics are illustrated in Figure 8. The chart illustrates the approximate time required to make a transition from one probe well temperature to another. First, determine the current probe well temperature and go to the corresponding row. Next, decide the new target plate temperature and go to the appropriate column. Note that there are X's along the diagonal where original and target temperatures are the same.

3.6 Replacing the Probe Well Inserts in the CL900A

As shown in Figure 1, there are several different probe well inserts available for the CL900A/CL900A-230. The CL900A is shipped with the CL906 insert (diameter=1/4", depth=6") and the CL900A-230 is shipped with the CL906-M insert (diameter=4.5 mm, depth=152.4 mm). 2 operations are required to be done at the same time to remove the probe well:

CAUTION

- Remove all electrical connections and power before attempting any maintenance.
- Never attempt to remove or insert a probe well insert while the probe well is still hot.

1. Pull the probe well insert release pin from the key ring loop, allowing the well insert clearance for removal. See Figure 2.
2. Remove the probe well insert using the extraction tool (HP-0037). The tool is first squeezed, inserted into the aperture of the probe well insert (aligning the pins of the tool with the holes insert). Then relaxed such that the pins separate, locking into the holes of the insert on either side of the shaft. Pull the pin out slowly. See Figure 6.

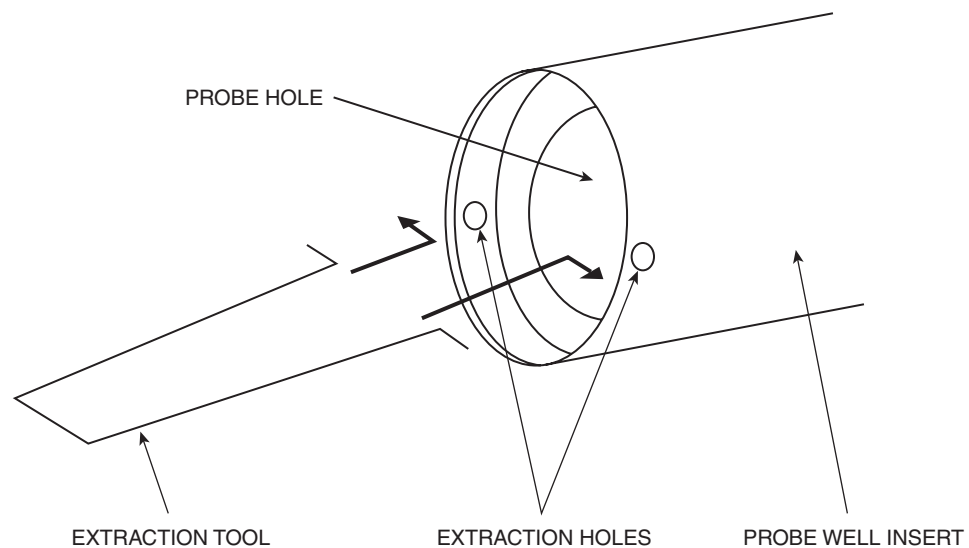

Figure 10. Removal of Probe Well Insert in CL900A

3.7 Fanning System

The CL900/950 has 2 cooling fans. One is mounted just under the top panel. The other is mounted just behind the rear panel.

The fans are activated whenever the unit is plugged into a live power outlet. Regardless of whether the power switch is on, the fan will run for a period of 2 hours or until the power is turned off. The fans will remain on as long as the unit is turned on. Once the the unit is switched from "ON" | mode to "STANDBY" ⏻ mode the fans will again run for 2 hours. **Never disconnect the power cord while the unit is still cooling down. A safety hazard may result and the unit may get damaged.**

CAUTION:

Never disconnect the power cord while the fan is still cooling down. A safety hazard may result and the unit may get damaged.

3.8 Overheat Reset Switch

In the event one or both of the fans fail and the temperature inside the unit raise to an unacceptable level, a thermal cutoff switch will disconnect the heater power. The controller will still display the desired setpoint temperature, however, the process temperature will keep falling or not rise at all. At this point the unit should be sent back to OMEGA for service.

Section 4 - Maintenance

4.1 Calibration

This unit has been fine tuned at the factory and calibrated to give optimum performance of its full temperature range. It is recommended that the unit be returned annually for re-calibration.

4.2 Cleaning

CAUTION:

Remove all electrical connections and power before attempting any maintenance or cleaning.

4.2.1 Main Body

Only a damp soft rag with a mild cleaning solution should be used when cleaning the main body of this unit.

4.2.2 Probe Well

Send the unit back to OMEGA in the event that the probe well becomes dirty. **Do not attempt remove the probe well from the unit.**

4.2.3 Fan and Vent Guards

The fan guard and vent guards should be cleaned as a minimum, annually. A medium power vacuum cleaner with a brush attachment is recommended.

4.3 Fuse replacement

WARNING:

Disconnect power from source before replacing fuse.

CAUTION:

For continued protection against the risk of fire replace with only the same size, type and rating fuse indicated here and on the rear panel of your unit.

For model:

CL900A/CL950A use

Fuse, 1 ea. T12A, 250 VAC~, (Time Delay)
VDE APPROVED (¼" dia. x 1 ¼ long).

CL900A-230/CL950A-230 use

Fuse, 2 ea. T6.3A, 250 VAC~, (Time Delay)
VDE APPROVED (5mm dia. x 20mm long).

NOTE:

Note that for the CL900A-230/CL950A-230 both fuses need to be checked if there is a suspicion that a fuse has been blown. One or both fuses may have been damaged.

Section 5 - RS232 Communication

This method allows bi-directional data transfer via a three conductor cable consisting of signal ground, receive input, and transmit output. It is recommended that less than fifty feet of cable be used between the computer and this instrument. Note that multiple instruments cannot be tied to the same port in this configuration. The RS232 port is optically isolated to eliminate ground loop problems.

Below is a pinout diagram for the serial port of the CL900A/CL950A as well as the pinout for a 9-pin PC serial port. Use a straight DB9(female) to DB9(male) connector cable to connect your computer to the CL900A. The cable should be attached when only when the computer and CL900A are off.

Only parameters in the parameter list should be modified or queried via the serial port. Other parameters should be viewed or queried from the controller, directly. It is highly recommended that baud rate for the controller be modified on the controller, directly. Note that both the CL900A and the computer must be communicating with the same serial communications parameters to establish a working communication link.

The serial communications feature can be tested using terminal emulation package. Note that this controller does not time out waiting for the next character to be transmitted. Be sure not to use the XON/XOFF or hardware handshaking. Lastly, it should be noted that following a complete transmission to the CL900A, a response it sent back. If the message was valid, the changed or queried parameter is echoed back (following the same format). If the message was not according to acceptable format or was attempting to force a parameter out of range, an "ERROR" message is echoed.

Note, only RS232 protocol is supported by the serial port. Voltage levels are not to exceed $\pm 12\text{VDC}$. A standard 9-wire cable should be used, with shielding and DB9 connectors. The CL900A/CL950A connections are female. Most computers have a 9-pin male connection. Hence, a male-female cable with straight through connections is appropriate for interfacing.

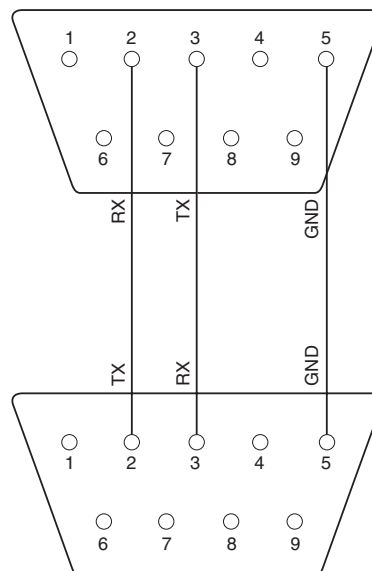

Figure 11. Connecting the CL900A to a Computer's Serial Port

Parameter List (only relevant parameters shown):

PAR#:	Parameter:	Range/Units:
00	Process Temp.	Input determined
01	Setpoint	Input determined
19	Baud Selection	bAUd

Baud Selections:

Code:	Baud:	Parity:	Data Bits:	Stop Bits:
3.o.7	300	odd	7	2
6.o.7	600	odd	7	2
12.o.7	1200	odd	7	2 (factory default settings)
24.o.7	1200	odd	7	2
3.n.8	300	no	8	1
6.n.8	600	no	8	1
12.n.8	1200	no	8	1
24.n.8	2400	no	8	1

General Message Format:

#[controller id][command][parameter number]<new value><units>[CR/LF]

Definitions:

- This character initiates an "escape sequence" that the controller will recognize.

[controller id] – Up to 2 numeric characters, '00' to '99' (factory default='01')

[command] – 1 character, upper case or lower case

‘R’ – To read a parameter from the controller

‘M’ – To temporarily modify a controller parameter (lost upon shutdown)

‘E’ – To modify a controller param. in non-volatile mem. (saved even after shutdown)

[parameter #] – Up to 2 numeric characters, '00' to '99'

<new value> - This control word is used only when entering or modifying a parameter.

Up to 6 characters may be entered. The first character can be a space, a '+', or a '-'. The next 4 characters are for entering the new value parameter value. Be sure to use the exact same field format as is currently being used. (i.e. if the XXX.X format is used to express temperature, be sure to enter a new value that conforms to the same format).

<units> - This optional control word is used to specify units, F for °F, C for °C.

[CR/LF] – Every transmission must be terminated with a carriage return [CR] character.

The line feed [LF] character is optional.

Section 6 - Specifications

Temperature Range:	Ambient + 22°C to 482°C Ambient + 40°F to 900°F
Operating Ambient Environmental Conditions:	
Temperature	5 to 38°C (40 to 100°F)
Humidity	0 to 90% RH, non-condensing
Accuracy:	
CL900A/CL900A-230 w/6" (152.5mm) Inserts	±0.8°C (±1.5°F) ±1 LSD
CL900A w/CL900A-230 w 4" (106.6mm) Inserts	±1.7°C (±3°F) ±1 LSD
CL950A	±0.8° C (±1.5°F) ±1 LSD
Resolution:	1°[F/C]
Control Stability:	±0.3 °F or better
Heat-up Time:	12 min. from 38°C to 398°C (from 100°F to 750°F)
Temperature Uniformity (Within the Bottom 1" of the Test Well):	
CL900A W/6" Well Inserts	±0.3% rdg
CL900A W/4" Well Inserts	±0.4% rdg
CL950A	±0.3% rdg
Max. Probe Immersion:	
CL900A W/6" Well Inserts	6" (150 mm)
CL900A W/4" Well Inserts	4" (100 mm)
CL950A	6" (150 mm)
Internal Control Sensor:	Platinum RTD, 100 W, alpha=.00385
Control:	Microprocessor-Based PID Digital Controller
Power:	
CL900A/CL950A	115 VAC~, 50/60Hz, 1010W
CL900A-230/CL950A-230VAC	230 VAC~, 50/60 Hz, 1010W
Dimensions:	12.3" L x 14.3" W x 7.5" H 312mm x 363mm x 191mm
Weight:	25 lb. (11.4 Kg)
Humidity:	0 to 90% RH, non-condensing

Section 7 - Troubleshooting Guide

Problem	Solution
1. Unit will not turn on.	<ul style="list-style-type: none">a. Check all electrical connections.b. Check rear panel fuses.c. Unit requires service, contact our customer service department.
2. Unit turns on but the probe well will not get hot.	<ul style="list-style-type: none">a. Check that you have entered a setpoint above the ambient temperature.b. Verify that the controller is set to its factory default settings.c. Unit requires service, contact our customer service department.d. Unit has been operated above ambient temperature operating range. Safety cutoff switch has disabled heater. Unit should be sent back to factory for reset and safety check.
3. Controller display shows "Err.H" and the probe well will not get hot.	<ul style="list-style-type: none">a. Unit requires service, contact our customer service department.
4. Probe well temperature will not stabilize to within $\pm 0.5^\circ$ of the setpoint temperature.	<ul style="list-style-type: none">a. Verify that the controller parameters are set to factory default settings.b. Unit requires service, contact our customer service department.d. Line voltage is not stable.

Section 8 - Glossary of Terms Used in This Manual

Calibration

The process of adjusting an instrument or compiling a deviation chart so that its reading can be correlated to the actual value being measured.

IEC

International Electrotechnical Commission

NIST

National Institute of Standards and Technology

PID

Proportional, Integral, Derivative. A three mode control action where the controller has time proportioning, integral (auto reset) and derivative rate action.

RTD

Resistance temperature detector

The OMEGA™ Family of Blackbody Calibrators

Listed below is a selection guide of OMEGA's current line of blackbody calibration sources in addition to the one you have selected. This family of rugged, portable and accurate calibrators cover a wide range of temperatures, target plate sizes and features making them perfect for infrared pyrometer field service testing and laboratory calibrations.

BB701 Hot/Cold Blackbody Calibration Source

Calibration Range: -18 to 149°C (0 to 300°F)

Emissivity: 0.95

Cavity Size: 63.5 mm (2.5 in.)

Accuracy: ±0.8°C (±1.4 °F)

Ambient Temp.: 4 to 43°C (40 to 110°F)

Power: 115/230V, 50/60 Hz, 175W

BB702 Blackbody Calibration Source

Calibration Range: 32 to 215°C (amb. 90 to 420°F)

Emissivity: 0.95

Cavity Size: 63.5 mm (2.5 in.)

Accuracy: ± 0.5°C (±0.9°F), ±0.25% rdg.

Ambient Temp.: 5 to 45°C (41 to 113°F)

Power: 115/230V, 50/60 Hz, 75W

BB703 Mini Blackbody Calibration Source

Calibration Range: 32 to 400°C (90 to 752°F)

Emissivity: 0.95

Cavity Size: 28.6 mm (1.125 in.)

Accuracy: ±1.4°C (±2.5°F)

Ambient Temp.: 0 to 40°C (32 to 104°F)

Power: 115/230V, 50/60 Hz, 175W

BB704 4" Target Plate Blackbody Calibration Source

Calibration Range: 100 to 400°C (212 to 752°F)

Emissivity: 0.95

Cavity Size: 101.6 mm (4 in.)

Accuracy: ±0.8°C (±1.4°F)

Ambient Temp.: 0 to 50°C (32 to 122°F)

Power: 115/230V, 50/60 Hz, 425W

BB705 Laboratory Grade Blackbody Calibration Source

Calibration Range: 100 to 1046°C (212 to 1915°F)

Emissivity: 0.99

Cavity Size: 44 mm (1.75 in.)

Accuracy: ±1.0°C (±1.8°F), ±0.25% rdg

Ambient Temp.: 0 to 35°C (32 to 95°F)

Power: 115/230V, 50/60 Hz, 1100W

BB-4A High Temperature Blackbody Calibration Source

Calibration Range: 100 to 982°C (212 to 1800°F)

Emissivity: 0.99

Cavity Size: 22.2 mm (0.88 in.)

Accuracy: ±1.0°C (±1.8°F), ±0.25% rdg

Ambient Temp.: 0 to 50°C (32 to 122°F)

Power: 115/230V, 50/60 Hz, 400W

For a complete, updated specification sheet and price on any of the calibrators listed here visit our website at www.omega.com. Please call our sales or customer service department for information and pricing on any new models available.



NOTES:



NOTES:



WARRANTY/DISCLAIMER

OMEGA ENGINEERING, INC. warrants this unit to be free of defects in materials and workmanship for a period of **13 months** from date of purchase. OMEGA's WARRANTY adds an additional one (1) month grace period to the normal **one (1) year product warranty** to cover handling and shipping time. This ensures that OMEGA's customers receive maximum coverage on each product.

If the unit malfunctions, it must be returned to the factory for evaluation. OMEGA's Customer Service Department will issue an Authorized Return (AR) number immediately upon phone or written request. Upon examination by OMEGA, if the unit is found to be defective, it will be repaired or replaced at no charge. OMEGA's WARRANTY does not apply to defects resulting from any action of the purchaser, including but not limited to mishandling, improper interfacing, operation outside of design limits, improper repair, or unauthorized modification. This WARRANTY is VOID if the unit shows evidence of having been tampered with or shows evidence of having been damaged as a result of excessive corrosion; or current, heat, moisture or vibration; improper specification; misapplication; misuse or other operating conditions outside of OMEGA's control. Components which wear are not warranted, including but not limited to contact points, fuses, and triacs.

OMEGA is pleased to offer suggestions on the use of its various products. However, OMEGA neither assumes responsibility for any omissions or errors nor assumes liability for any damages that result from the use of its products in accordance with information provided by OMEGA, either verbal or written. OMEGA warrants only that the parts manufactured by it will be as specified and free of defects. OMEGA MAKES NO OTHER WARRANTIES OR REPRESENTATIONS OF ANY KIND WHATSOEVER, EXPRESS OR IMPLIED, EXCEPT THAT OF TITLE, AND ALL IMPLIED WARRANTIES INCLUDING ANY WARRANTY OF MERCHANTABILITY AND FITNESS FOR A PARTICULAR PURPOSE ARE HEREBY DISCLAIMED. LIMITATION OF LIABILITY: The remedies of purchaser set forth herein are exclusive, and the total liability of OMEGA with respect to this order, whether based on contract, warranty, negligence, indemnification, strict liability or otherwise, shall not exceed the purchase price of the component upon which liability is based. In no event shall OMEGA be liable for consequential, incidental or special damages.

CONDITIONS: Equipment sold by OMEGA is not intended to be used, nor shall it be used: (1) as a "Basic Component" under 10 CFR 21 (NRC), used in or with any nuclear installation or activity; or (2) in medical applications or used on humans. Should any Product(s) be used in or with any nuclear installation or activity, medical application, used on humans, or misused in any way, OMEGA assumes no responsibility as set forth in our basic WARRANTY/DISCLAIMER language, and, additionally, purchaser will indemnify OMEGA and hold OMEGA harmless from any liability or damage whatsoever arising out of the use of the Product(s) in such a manner.

RETURN REQUESTS/INQUIRIES

Direct all warranty and repair requests/inquiries to the OMEGA Customer Service Department. BEFORE RETURNING ANY PRODUCT(S) TO OMEGA, PURCHASER MUST OBTAIN AN AUTHORIZED RETURN (AR) NUMBER FROM OMEGA'S CUSTOMER SERVICE DEPARTMENT (IN ORDER TO AVOID PROCESSING DELAYS). The assigned AR number should then be marked on the outside of the return package and on any correspondence.

The purchaser is responsible for shipping charges, freight, insurance and proper packaging to prevent breakage in transit.

FOR **WARRANTY** RETURNS, please have the following information available BEFORE contacting OMEGA:

1. Purchase Order number under which the product was PURCHASED,
2. Model and serial number of the product under warranty, and
3. Repair instructions and/or specific problems relative to the product.

FOR **NON-WARRANTY** REPAIRS, consult OMEGA for current repair charges. Have the following information available BEFORE contacting OMEGA:

1. Purchase Order number to cover the COST of the repair,
2. Model and serial number of the product, and
3. Repair instructions and/or specific problems relative to the product.

OMEGA's policy is to make running changes, not model changes, whenever an improvement is possible. This affords our customers the latest in technology and engineering.

OMEGA is a registered trademark of OMEGA ENGINEERING, INC.

© Copyright 2003 OMEGA ENGINEERING, INC. All rights reserved. This document may not be copied, photocopied, reproduced, translated, or reduced to any electronic medium or machine-readable form, in whole or in part, without the prior written consent of OMEGA ENGINEERING, INC.

Where Do I Find Everything I Need for Process Measurement and Control? **OMEGA...Of Course!**

Shop online at www.omega.com

TEMPERATURE

- ☑ Thermocouple, RTD & Thermistor Probes, Connectors, Panels & Assemblies
- ☑ Wire: Thermocouple, RTD & Thermistor
- ☑ Calibrators & Ice Point References
- ☑ Recorders, Controllers & Process Monitors
- ☑ Infrared Pyrometers

PRESSURE, STRAIN AND FORCE

- ☑ Transducers & Strain Gages
- ☑ Load Cells & Pressure Gages
- ☑ Displacement Transducers
- ☑ Instrumentation & Accessories

FLOW/LEVEL

- ☑ Rotameters, Gas Mass Flowmeters & Flow Computers
- ☑ Air Velocity Indicators
- ☑ Turbine/Paddlewheel Systems
- ☑ Totalizers & Batch Controllers

pH/CONDUCTIVITY

- ☑ pH Electrodes, Testers & Accessories
- ☑ Benchtop/Laboratory Meters
- ☑ Controllers, Calibrators, Simulators & Pumps
- ☑ Industrial pH & Conductivity Equipment

DATA ACQUISITION

- ☑ Data Acquisition & Engineering Software
- ☑ Communications-Based Acquisition Systems
- ☑ Plug-in Cards for Apple, IBM & Compatibles
- ☑ Datalogging Systems
- ☑ Recorders, Printers & Plotters

HEATERS

- ☑ Heating Cable
- ☑ Cartridge & Strip Heaters
- ☑ Immersion & Band Heaters
- ☑ Flexible Heaters
- ☑ Laboratory Heaters

ENVIRONMENTAL MONITORING AND CONTROL

- ☑ Metering & Control Instrumentation
- ☑ Refractometers
- ☑ Pumps & Tubing
- ☑ Air, Soil & Water Monitors
- ☑ Industrial Water & Wastewater Treatment
- ☑ pH, Conductivity & Dissolved Oxygen Instruments