

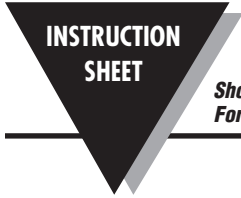

DPF260

1/8 DIN Digital Input Panel Meter



MQS5314-0713

Shop online at: omega.com e-mail: info@omega.com
For latest product manuals: omegamanual.info



SPECIFICATIONS

POWER:

- AC Power: 40 to 250 VAC, 50/60 Hz, 20 VA
- DC Power: 21.6 to 250 VDC, 8 W
- Isolation: 2300 Vrms for 1 min. to all inputs and outputs.

INPUTS A and B:

- DIP switch selectable to accept pulses from a variety of sources including switch contacts, TTL outputs, and magnetic pickups.
- LOGIC: Input trigger levels $V_{IL} = 1.5 \text{ V max.}$; $V_{IH} = 3.75 \text{ V min.}$
- Current sinking: Internal $7.8 \text{ K}\Omega$ pull-up to +5 VDC, $I_{MAX} = 0.7 \text{ mA.}$
- Current sourcing: Internal $3.9 \text{ K}\Omega$ pull-down, $7.3 \text{ mA max. @ } 28 \text{ VDC,}$
 $V_{MAX} = 30 \text{ VDC.}$

Filter: Damping capacitor provided for switch contact bounce. Limits input frequency to 50 Hz and input pulse widths to 10 msec. minimum.

MAGNETIC PICKUP:

- Sensitivity: 200 mV peak
- Hysteresis: 100 mV
- Input impedance: $3.9 \text{ K}\Omega @ 60 \text{ Hz}$; Must also have SRC switch ON. (Not recommended with counting applications.)
- Maximum input voltage: $\pm 40 \text{ V peak, } 28 \text{ Vrms}$

DUAL COUNT MODES:

When any dual count mode is used, then User Inputs 1 and/or 2 will accept the second signal of each signal pair. The user inputs do not have the Logic/Mag, HI/LO Freq, and Sink/Source input setup switches. The user inputs are inherently a logic input with no low frequency filtering. Any mechanical contacts used for these inputs in a dual count mode must be debounced externally. The user input may only be selected for sink/source by the User Jumper placement.

SENSOR POWER:

+18 VDC, $\pm 5\% @ 60 \text{ mA max.}$; short circuit protected

USER INPUTS:

- Three programmable user inputs
- Max. Continuous Input: 30 VDC
- Isolation To Sensor Input Common: Not isolated.

PRESCALER OUTPUT:

NPN Open Collector: $I_{SNK} = 100 \text{ mA max. @ } V_{OL} = 1 \text{ VDC max. } V_{OH} = 30 \text{ VDC max.}$ Duty cycle 25% min. and 50 % max.

ENVIRONMENTAL CONDITIONS:

- Operating Temperature Range: 0 to 50 °C
- Storage Temperature Range: -40 to 60 °C
- Vibration to IEC 68-2-6: Operational 5-150 Hz, 2 g
- Shock to IEC 68-2-27: Operational 25 g (10 g relay)
- Operating and Storage Humidity: 0 to 85% max. RH non-condensing
- Altitude: Up to 2000 meters

CERTIFICATIONS AND COMPLIANCES:

CE Approved

- EN 61326-1 Immunity to Industrial Locations
- Emission CISPR 11 Class A
- IEC/EN 61010-1
- RoHS Compliant

UL Listed: File #E70366

- Type 4X Indoor Enclosure rating (Face only)
- IP65 Enclosure rating (Face only)
- IP20 Enclosure rating (Rear of unit)

CONNECTIONS:

- High compression cage-clamp terminal block
- Wire Strip Length: 0.3" (7.5 mm)
- Wire Gauge Capacity: One 14 AWG (2.55 mm) solid,
two 18 AWG (1.02 mm) or four 20 AWG (0.61 mm)

CONSTRUCTION:

- This unit is rated NEMA 4X/IP65 for indoor use only.
- IP20 Touch safe. Installation Category II, Pollution Degree 2. One piece bezel/ case. Flame resistant. Synthetic rubber keypad. Panel gasket and mounting clip included.

WEIGHT:

8 oz. (226.8 g)

DIMENSIONS In inches (mm)

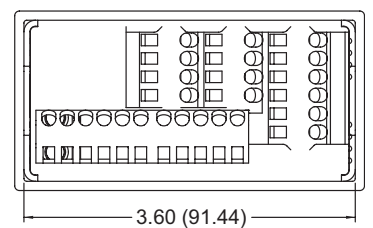
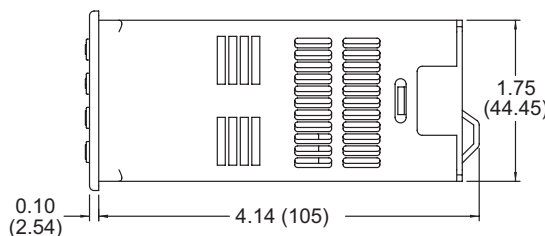
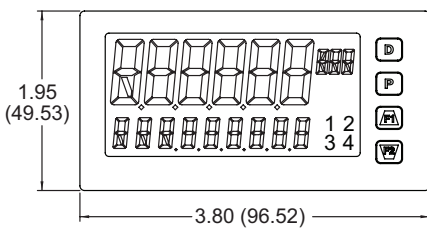

Note: Recommended minimum clearance (behind the panel) for mounting clip installation is 2.1" (53.4) H x 5.5" (140) W.

SAFETY SUMMARY

All safety related regulations, local codes and instructions that appear in this literature or on equipment must be observed to ensure personal safety and to prevent damage to either the instrument or equipment connected to it. If equipment is used in a manner not specified by the manufacturer, the protection provided by the equipment may be impaired. Do not use this unit to directly command motors, valves, or other actuators not equipped with safeguards. To do so can be potentially harmful to persons or equipment in the event of a fault to the unit.



CAUTION: Risk of Danger.
Read complete instructions prior to installation and operation of the unit.



CAUTION:
Risk of electric shock.

METER INSTALLATION

The DPF260 meets NEMA 4X/IP65 requirements when properly installed. The unit is intended to be mounted into an enclosed panel. Prepare the panel cutout to the dimensions shown. Remove the panel latch from the unit. Slide the panel gasket over the rear of the unit to the back of the bezel. The unit should be installed fully assembled. Insert the unit into the panel cutout.

While holding the unit in place, push the panel latch over the rear of the unit so that the tabs of the panel latch engage in the slots on the case. The panel latch should be engaged in the farthest forward slot possible. To achieve a proper seal, tighten the latch screws evenly until the unit is snug in the panel (Torque to approximately 7 in-lbs [79N-cm]). Do not over-tighten the screws.

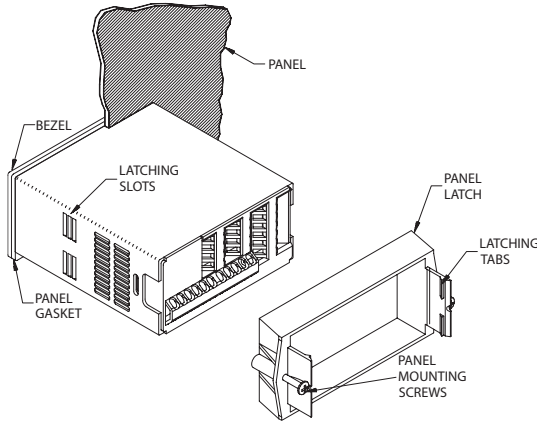

Installation Environment

The unit should be installed in a location that does not exceed the operating temperature and provides good air circulation. Placing the unit near devices that generate excessive heat should be avoided.

PANEL CUT-OUT

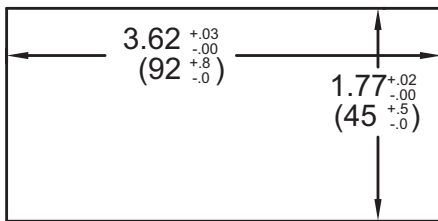

POWER WIRING

The power supplied to the meter shall employ a 15 Amp UL approved circuit breaker for AC input and a 1 Amp, 250 V UL approved fuse for DC input. It shall be easily accessible and marked as a disconnecting device to the installed unit. This device is not directly intended for connection to the mains without a reliable means to reduce transient over-voltages to 1500 V.

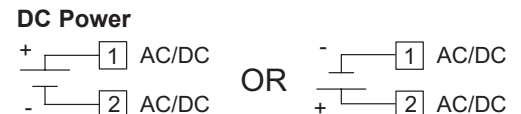
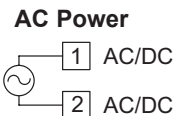

SETTING THE DIP SWITCHES

To access the switches, remove the meter base from the case by firmly squeezing and pulling back on the side rear finger tabs. This should lower the latch below the case slot (which is located just in front of the finger tabs). It is recommended to release the latch on one side, then start the other side latch.



Warning: Exposed line voltage exists on the circuit boards. Remove all power to the meter and load circuits before accessing inside of the meter.

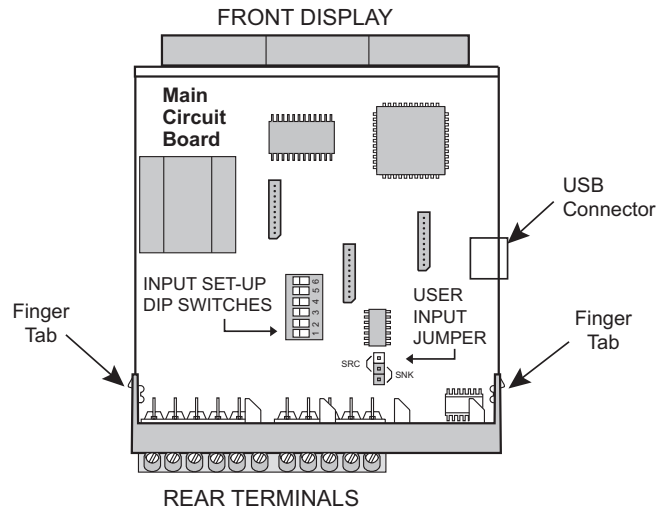

SETTING THE INPUT DIP SWITCHES

The meter has six DIP switches for Input A and Input B terminal set-up that must be set before applying power.

Input B LO Freq.	<input type="checkbox"/>	6	HI Freq.
Input B SRC.	<input type="checkbox"/>	5	SNK.
Input B MAG.	<input type="checkbox"/>	4	Logic
Input A LO Freq.	<input type="checkbox"/>	3	HI Freq.
Input A SRC.	<input type="checkbox"/>	2	SNK.
Input A MAG.	<input type="checkbox"/>	1	Logic
	<input checked="" type="checkbox"/>		Factory Setting

SWITCHES 1 and 4

LOGIC: Input trigger levels $V_{IL} = 1.5 \text{ V max.}$; $V_{IH} = 3.75 \text{ V min.}$

MAG: 200 mV peak input sensitivity; 100 mV hysteresis; maximum voltage: $\pm 40 \text{ V peak (28 Vrms)}$; Input impedance: $3.9 \text{ K}\Omega @ 60 \text{ Hz}$; Must also have SRC switch ON. (Not recommended with counting applications.)

SWITCHES 2 and 5

SNK.: Adds internal $7.8 \text{ K}\Omega$ pull-up resistor to +5 VDC, $I_{MAX} = 0.7 \text{ mA}$.

SRC.: Adds internal $3.9 \text{ K}\Omega$ pull-down resistor, $7.3 \text{ mA max. @ 28 VDC}$, $V_{MAX} = 30 \text{ VDC}$.

SWITCHES 3 and 6

HI Frequency: Removes damping capacitor and allows max. frequency.

LO Frequency: Adds a damping capacitor for switch contact bounce. Also limits input frequency to maximum 50 Hz and input pulse widths to minimum 10 msec.

INPUT SIGNAL WIRING



CAUTION: Sensor input common is NOT isolated from user input common. In order to preserve the safety of the meter application, the sensor input common must be suitably isolated from hazardous live earth referenced voltage; or input common must be at protective earth ground potential. If not, hazardous voltage may be present at the User Inputs and User Input Common terminals. Appropriate considerations must then be given to the potential of the user input common with respect to earth ground; and the common of the isolated plug-in cards with respect to input common.

If you are wiring Input B, connect signal to Terminal 6 instead of 5, and set DIP switches 4, 5, and 6 to the positions shown for 1, 2, and 3.

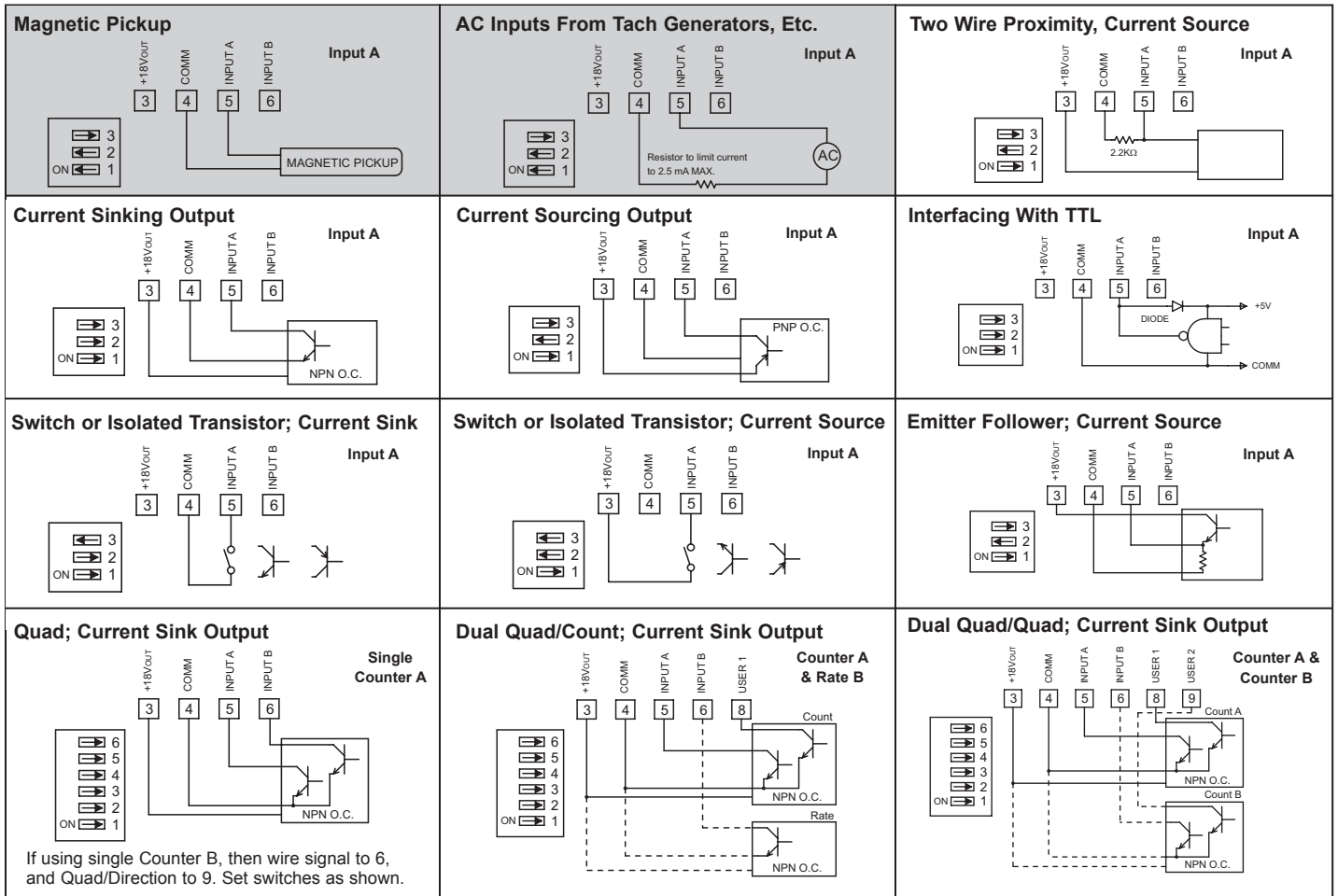

Shaded areas not recommended for counting applications.

USER INPUT WIRING

If User Input 1 and/or 2 are wired for quadrature or directional counting, an additional switching device should not be connected to that User Input terminal. User Input terminal does not need to be wired in order to remain in inactive state.

Sinking Logic ($USrACt L0$)

When the $USrACt$ parameter is programmed to $L0$, the user inputs of the meter are internally pulled up to +3.3 V with 20 K Ω resistance. The input is active when it is pulled low (<1.1 V).

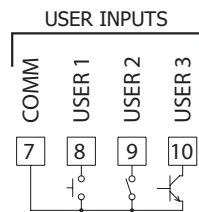

Sourcing Logic ($USrACt H1$)

When the $USrACt$ parameter is programmed to $H1$, the user inputs of the meter are internally pulled down to 0 V with 20 K Ω resistance. The input is active when a voltage greater than 2.2 VDC is applied.

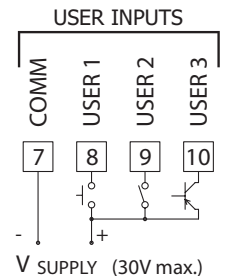

PRESCALER OUTPUT WIRING (NPN O.C.)

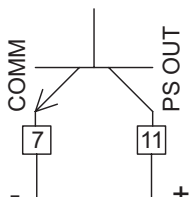

SETPOINT (ALARMS) WIRING SERIAL COMMUNICATION WIRING ANALOG OUTPUT WIRING

See appropriate plug-in card bulletin for wiring details.



OMEGAnet® Online Service
omega.com

Internet e-mail
info@omega.com

Servicing North America:

U.S.A.:
ISO 9001 Certified

One Omega Drive, P.O. Box 4047
Stamford, CT 06907-0047
TEL: (203) 359-1660
FAX: (203) 359-7700
e-mail: info@omega.com

Canada:

976 Bergar
Laval (Quebec) H7L 5A1, Canada
TEL: (514) 856-6928
FAX: (514) 856-6886
e-mail: info@omega.ca

For immediate technical or application assistance:

U.S.A. and Canada: Sales Service: 1-800-826-6342/1-800-TC-OMEGA®
Customer Service: 1-800-622-2378/1-800-622-BEST®
Engineering Service: 1-800-872-9436/1-800-USA-WHEN®

Mexico:

En Español: (001) 203-359-7803
e-mail: espanol@omega.com
FAX: (001) 203-359-7807
info@omega.com.mx

Servicing Europe:

Czech Republic:

Frystatska 184, 733 01 Karviná, Czech Republic
TEL: +420 (0)59 6311899
FAX: +420 (0)59 6311114
Toll Free: 0800-1-66342
e-mail: info@omegashop.cz

Germany/Austria:

Daimlerstrasse 26, D-75392 Deckenpfronn, Germany
TEL: +49 (0)7056 9398-0
FAX: +49 (0)7056 9398-29
Toll Free in Germany: 0800 639 7678
e-mail: info@omega.de

United Kingdom:
ISO 9002 Certified

One Omega Drive, River Bend Technology Centre
Northbank, Irlam, Manchester
M44 5BD United Kingdom
TEL: +44 (0)161 777 6611
FAX: +44 (0)161 777 6622
Toll Free in United Kingdom: 0800-488-488
e-mail: sales@omega.co.uk

It is the policy of OMEGA Engineering, Inc. to comply with all worldwide safety and EMC/EMI regulations that apply. OMEGA is constantly pursuing certification of its products to the European New Approach Directives. OMEGA will add the CE mark to every appropriate device upon certification.

The information contained in this document is believed to be correct, but OMEGA accepts no liability for any errors it contains, and reserves the right to alter specifications without notice.
WARNING : These products are not designed for use in, and should not be used for, human applications.

WARRANTY/DISCLAIMER

OMEGA ENGINEERING, INC. warrants this unit to be free of defects in materials and workmanship for a period of **25 months** from date of purchase. OMEGA's WARRANTY adds an additional one (1) month grace period to the normal **two (2) year product warranty** to cover handling and shipping time. This ensures that OMEGA's customers receive maximum coverage on each product.

If the unit malfunctions, it must be returned to the factory for evaluation. OMEGA's Customer Service Department will issue an Authorized Return (AR) number immediately upon phone or written request. Upon examination by OMEGA, if the unit is found to be defective, it will be repaired or replaced at no charge. OMEGA's WARRANTY does not apply to defects resulting from any action of the purchaser, including but not limited to mishandling, improper interfacing, operation outside of design limits, improper repair, or unauthorized modification. This WARRANTY is VOID if the unit shows evidence of having been tampered with or shows evidence of having been damaged as a result of excessive corrosion; or current, heat, moisture or vibration; improper specification; misapplication; misuse or other operating conditions outside of OMEGA's control. Components in which wear is not warranted, include but are not limited to contact points, fuses, and triacs.

OMEGA is pleased to offer suggestions on the use of its various products. However, OMEGA neither assumes responsibility for any omissions or errors nor assumes liability for any damages that result from the use of its products in accordance with information provided by OMEGA, either verbal or written. OMEGA warrants only that the parts manufactured by the company will be as specified and free of defects. OMEGA MAKES NO OTHER WARRANTIES OR REPRESENTATIONS OF ANY KIND WHATSOEVER, EXPRESSED OR IMPLIED, EXCEPT THAT OF TITLE, AND ALL IMPLIED WARRANTIES INCLUDING ANY WARRANTY OF MERCHANTABILITY AND FITNESS FOR A PARTICULAR PURPOSE ARE HEREBY DISCLAIMED. LIMITATION OF LIABILITY: The remedies of purchaser set forth herein are exclusive, and the total liability of OMEGA with respect to this order, whether based on contract, warranty, negligence, indemnification, strict liability or otherwise, shall not exceed the purchase price of the component upon which liability is based. In no event shall OMEGA be liable for consequential, incidental or special damages.

CONDITIONS: Equipment sold by OMEGA is not intended to be used, nor shall it be used: (1) as a "Basic Component" under 10 CFR 21 (NRC), used in or with any nuclear installation or activity; or (2) in medical applications or used on humans. Should any Product(s) be used in or with any nuclear installation or activity, medical application, used on humans, or misused in any way, OMEGA assumes no responsibility as set forth in our basic WARRANTY/DISCLAIMER language, and, additionally, purchaser will indemnify OMEGA and hold OMEGA harmless from any liability or damage whatsoever arising out of the use of the Product(s) in such a manner.

RETURN REQUESTS/INQUIRIES

Direct all warranty and repair requests/inquiries to the OMEGA Customer Service Department. BEFORE RETURNING ANY PRODUCT(S) TO OMEGA, PURCHASER MUST OBTAIN AN AUTHORIZED RETURN (AR) NUMBER FROM OMEGA'S CUSTOMER SERVICE DEPARTMENT (IN ORDER TO AVOID PROCESSING DELAYS). The assigned AR number should then be marked on the outside of the return package and on any correspondence. The purchaser is responsible for shipping charges, freight, insurance and proper packaging to prevent breakage in transit.

FOR **WARRANTY** RETURNS, please have the following information available BEFORE contacting OMEGA:

1. Purchase Order number under which the product was PURCHASED,
2. Model and serial number of the product under warranty, and
3. Repair instructions and/or specific problems relative to the product.

FOR **NON-WARRANTY** REPAIRS, consult OMEGA for current repair charges. Have the following information available BEFORE contacting OMEGA:

1. Purchase Order number to cover the COST of the repair,
2. Model and serial number of the product, and
3. Repair instructions and/or specific problems relative to the product.

OMEGA's policy is to make running changes, not model changes, whenever an improvement is possible. This affords our customers the latest in technology and engineering. OMEGA is a registered trademark of OMEGA ENGINEERING, INC.

© Copyright 2006 OMEGA ENGINEERING, INC. All rights reserved. This document may not be copied, photocopied, reproduced, translated, or reduced to any electronic medium or machine-readable form, in whole or in part, without the prior written consent of OMEGA ENGINEERING, INC.