

5 YEAR
WARRANTY



RoHS

Ω OMEGA® **User's Guide**



Shop online at
***omega.com*SM**

e-mail: info@omega.com
For latest product manuals:
www.omegamanual.info

TX206TH **"Smart" In-Head Transmitter**



omega.com info@omega.com

Servicing North America:

**U.S.A.
Headquarters:**

Omega Engineering, Inc.

Toll-Free: 1-800-826-6342 (USA & Canada only)

Customer Service: 1-800-622-2378 (USA & Canada only)

Engineering Service: 1-800-872-9436 (USA & Canada only)

Tel: (203) 359-1660

Fax: (203) 359-7700

e-mail: info@omega.com

For Other Locations Visit omega.com/worldwide

SMART THERMISTOR INPUT - TWO WIRE (4 to 20) mA OUTPUT TRANSMITTER USER MANUAL



IMPORTANT - CE & SAFETY REQUIREMENTS

This product must be mounted inside a suitable enclosure providing environmental protection = > IP65.

To maintain CE compliance all input wires must be less than 3 metres.

The product contains no user serviceable parts, or internal adjustments. No attempt should be made to repair this device. Faulty units must be returned to supplier or manufacturer for repair or replacement.

This product must be installed by competent qualified personnel.

All electrical wiring must be installed to comply with the area standards, regulations.

Before attempting electrical connection ensure all supplies are switched off.

ABSOLUTE MAXIMUM OPERATING CONDITIONS :-

Supply	30 V dc (reverse protected to -30 V dc)
Supply Current on over voltage	+ 100 mA (when supply exceeds 30 V dc protection device will conduct)
Input voltage	± 3.0 V
Ambient	(-40 to 85) °C



PLEASE REFER TO THE PRODUCT LABEL FOR MANUFACTURERS CONTACT DETAILS.

Every effort has been taken to ensure the accuracy of this document, however we do not accept responsibility for damage, injury, loss or expense resulting from errors and omissions, and we reserve the right of amendment without notice.

RECEIVE AND UNPACKING

Please inspect the packaging and instrument thoroughly for any signs of transit damage. If the instrument has been damaged, please notify your supplier immediately.

SPECIFICATION (please refer to data sheet for full technical specification.)



MECHANICAL INSTALLATION

MOUNTING



SIDE VIEW

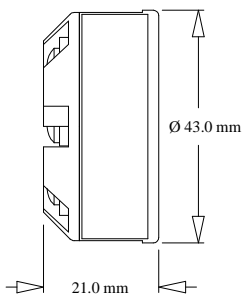

BASE VIEW

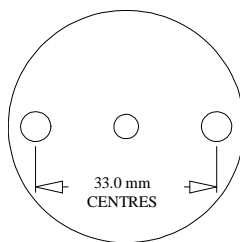

The device is mounted using two 5.5 mm holes, on standard 33 mm fixing centres and will fit a DIN standard termination head. The device must be installed with adequate protection from moisture and corrosive atmospheres.

Care must be taken to ensure the device is located to ensure the ambient temperature does not exceed the specified operating temperature.



ELECTRICAL INSTALLATION

Wire sensor.

Sensor connections are as follows, to maintain BS EN61326 compliance sensor wires must be less than 3 metres. All sensor connections must be isolated from ground. Screened or twisted pair cable recommended for (4 to 20) mA loop.

Thermistor

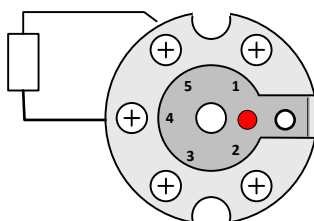

Wire (4 to 20) mA Loop

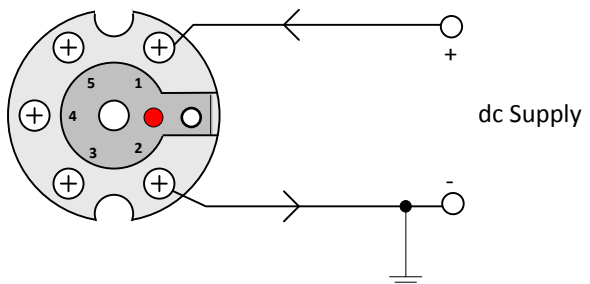

PC SENSOR AND RANGE CONFIGURATION

To carry out PC configuration the USB Configurator Kit is required. This is available from your supplier.

This product is configured using the USB port of a PC running USBSpeedLink software, available from your supplier's web site. During configuration the product is powered direct from the usb port, removing the need for additional power. USBSpeedLink software is provided with detailed help menus to guide the user through the simple configuration procedure. Unless specified at the time of order this product is supplied with the default configuration listed below.

Connect red wire to + terminal, black wire to - terminal of the Transmitter.



Factory default:
 Input range = YSI 10K B
 Process Output = (0 to 100) °C
 Output range = (4 to 20) mA
 Error = 21.0 mA
 Tag =

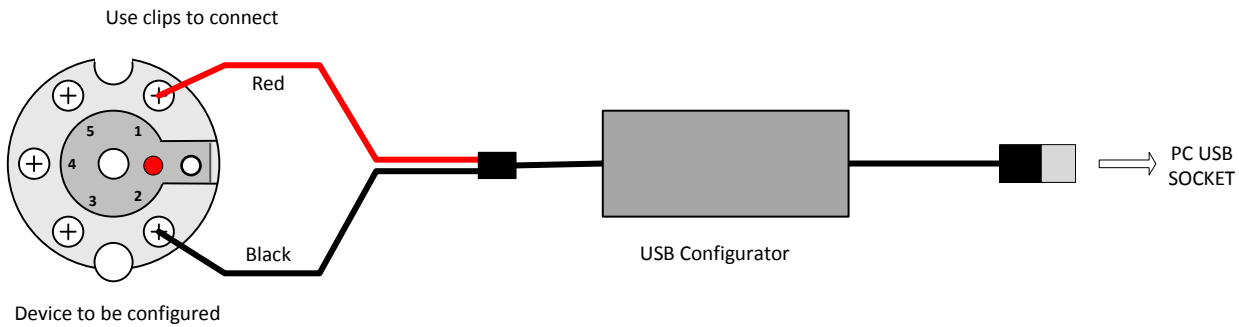
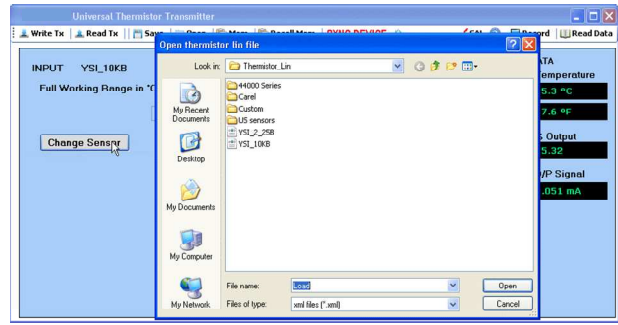
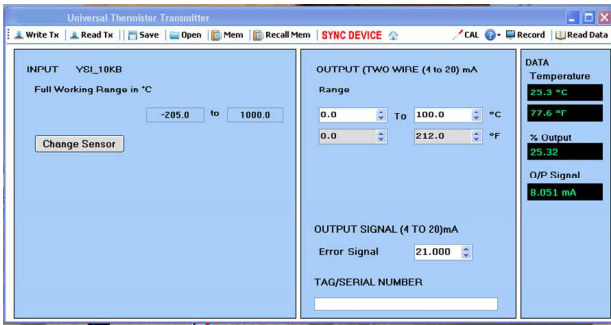

MANUAL RANGE (ONLY) CONFIGURATION

Equipment - Precision resistance box, DC power supply (voltage between (10 to 30) V dc), Screwdriver to operate push button and mA meter to monitor loop current.

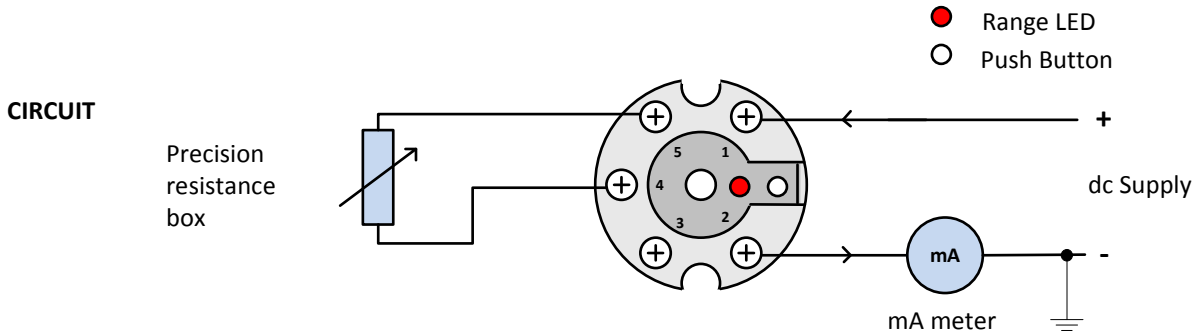

(Refer to thermistor tables for correct sensor resistance)

1. Connect the circuit as shown above.
2. Set the precision resistance box representative value for low scale (4 mA out) sensor resistance. Allow ten seconds settling time. (Refer to thermistor tables for correct sensor resistance)
3. Press and hold push button (for about five seconds) until the range LED starts to flash. This indicates the new low range setting has been stored.
4. Set the precision resistance box to the representative value for high scale (20 mA out) sensor resistance. Allow ten seconds settling time.
5. Press and release push button to store new high range setting. The Range LED will flash at a faster rate to indicate storing new value.
6. Device returns to normal operation.

WARRANTY/DISCLAIMER

OMEGA ENGINEERING, INC. warrants this unit to be free of defects in materials and workmanship for a period of **61 months** from date of purchase. OMEGA's WARRANTY adds an additional one (1) month grace period to the normal **five (5) year product warranty** to cover handling and shipping time. This ensures that OMEGA's customers receive maximum coverage on each product.

If the unit malfunctions, it must be returned to the factory for evaluation. OMEGA's Customer Service Department will issue an Authorized Return (AR) number immediately upon phone or written request. Upon examination by OMEGA, if the unit is found to be defective, it will be repaired or replaced at no charge. OMEGA's WARRANTY does not apply to defects resulting from any action of the purchaser, including but not limited to mishandling, improper interfacing, operation outside of design limits, improper repair, or unauthorized modification. This WARRANTY is VOID if the unit shows evidence of having been tampered with or shows evidence of having been damaged as a result of excessive corrosion; or current, heat, moisture or vibration; improper specification; misapplication; misuse or other operating conditions outside of OMEGA's control. Components in which wear is not warranted, include but are not limited to contact points, fuses, and triacs.

OMEGA is pleased to offer suggestions on the use of its various products. However, OMEGA neither assumes responsibility for any omissions or errors nor assumes liability for any damages that result from the use of its products in accordance with information provided by OMEGA, either verbal or written. OMEGA warrants only that the parts manufactured by the company will be as specified and free of defects. OMEGA MAKES NO OTHER WARRANTIES OR REPRESENTATIONS OF ANY KIND WHATSOEVER, EXPRESSED OR IMPLIED, EXCEPT THAT OF TITLE, AND ALL IMPLIED WARRANTIES INCLUDING ANY WARRANTY OF MERCHANTABILITY AND FITNESS FOR A PARTICULAR PURPOSE ARE HEREBY DISCLAIMED. LIMITATION OF LIABILITY: The remedies of purchaser set forth herein are exclusive, and the total liability of OMEGA with respect to this order, whether based on contract, warranty, negligence, indemnification, strict liability or otherwise, shall not exceed the purchase price of the component upon which liability is based. In no event shall OMEGA be liable for consequential, incidental or special damages.

CONDITIONS: Equipment sold by OMEGA is not intended to be used, nor shall it be used: (1) as a "Basic Component" under 10 CFR 21 (NRC), used in or with any nuclear installation or activity; or (2) in medical applications or used on humans. Should any Product(s) be used in or with any nuclear installation or activity, medical application, used on humans, or misused in any way, OMEGA assumes no responsibility as set forth in our basic WARRANTY/DISCLAIMER language, and, additionally, purchaser will indemnify OMEGA and hold OMEGA harmless from any liability or damage whatsoever arising out of the use of the Product(s) in such a manner.

RETURN REQUESTS/INQUIRIES

Direct all warranty and repair requests/inquiries to the OMEGA Customer Service Department. BEFORE RETURNING ANY PRODUCT(S) TO OMEGA, PURCHASER MUST OBTAIN AN AUTHORIZED RETURN (AR) NUMBER FROM OMEGA'S CUSTOMER SERVICE DEPARTMENT (IN ORDER TO AVOID PROCESSING DELAYS). The assigned AR number should then be marked on the outside of the return package and on any correspondence.

The purchaser is responsible for shipping charges, freight, insurance and proper packaging to prevent breakage in transit.

FOR **WARRANTY** RETURNS, please have the following information available BEFORE contacting OMEGA:

1. Purchase Order number under which the product was PURCHASED,
2. Model and serial number of the product under warranty, and
3. Repair instructions and/or specific problems relative to the product.

FOR **NON-WARRANTY** REPAIRS, consult OMEGA for current repair charges. Have the following information available BEFORE contacting OMEGA:

1. Purchase Order number to cover the COST of the repair,
2. Model and serial number of the product, and
3. Repair instructions and/or specific problems relative to the product.

OMEGA's policy is to make running changes, not model changes, whenever an improvement is possible. This affords our customers the latest in technology and engineering.

OMEGA is a registered trademark of OMEGA ENGINEERING, INC.

© Copyright 2016 OMEGA ENGINEERING, INC. All rights reserved. This document may not be copied, photocopied, reproduced, translated, or reduced to any electronic medium or machine-readable form, in whole or in part, without the prior written consent of OMEGA ENGINEERING, INC.

Where Do I Find Everything I Need for Process Measurement and Control? **OMEGA...Of Course!** *Shop online at omega.comSM*

TEMPERATURE

- ☑ Thermocouple, RTD & Thermistor Probes, Connectors, Panels & Assemblies
- ☑ Wire: Thermocouple, RTD & Thermistor
- ☑ Calibrators & Ice Point References
- ☑ Recorders, Controllers & Process Monitors
- ☑ Infrared Pyrometers

PRESSURE, STRAIN AND FORCE

- ☑ Transducers & Strain Gages
- ☑ Load Cells & Pressure Gages
- ☑ Displacement Transducers
- ☑ Instrumentation & Accessories

FLOW/LEVEL

- ☑ Rotameters, Gas Mass Flowmeters & Flow Computers
- ☑ Air Velocity Indicators
- ☑ Turbine/Paddlewheel Systems
- ☑ Totalizers & Batch Controllers

pH/CONDUCTIVITY

- ☑ pH Electrodes, Testers & Accessories
- ☑ Benchtop/Laboratory Meters
- ☑ Controllers, Calibrators, Simulators & Pumps
- ☑ Industrial pH & Conductivity Equipment

DATA ACQUISITION

- ☑ Communications-Based Acquisition Systems
- ☑ Data Logging Systems
- ☑ Wireless Sensors, Transmitters, & Receivers
- ☑ Signal Conditioners
- ☑ Data Acquisition Software

HEATERS

- ☑ Heating Cable
- ☑ Cartridge & Strip Heaters
- ☑ Immersion & Band Heaters
- ☑ Flexible Heaters
- ☑ Laboratory Heaters

ENVIRONMENTAL MONITORING AND CONTROL

- ☑ Metering & Control Instrumentation
- ☑ Refractometers
- ☑ Pumps & Tubing
- ☑ Air, Soil & Water Monitors
- ☑ Industrial Water & Wastewater Treatment
- ☑ pH, Conductivity & Dissolved Oxygen Instruments