

1 YEAR
WARRANTY



OMEGA® User's Guide



**Shop online at
omega.com®**

**e-mail: info@omega.com
For latest product manuals:
www.omegamanual.info**

MADE IN TAIWAN

HHWT-SD1 pH, ORP, Conductivity, TDS, Salt and DO Meter with Data Logging SD Card



omega.com info@omega.com

Servicing North America:

U.S.A.:

Omega Engineering, Inc., One Omega Drive, P.O. Box 4047
Stamford, CT 06907-0047 USA

Toll-Free: 1-800-826-6342 (USA & Canada only)

Customer Service: 1-800-622-2378 (USA & Canada only)

Engineering Service: 1-800-872-9436 (USA & Canada only)

Tel: (203) 359-1660

Fax: (203) 359-7700

e-mail: info@omega.com

For Other Locations Visit omega.com/worldwide

The information contained in this document is believed to be correct, but OMEGA accepts no liability for any errors it contains, and reserves the right to alter specifications without notice.

WARNING: These products are not designed for use in, and should not be used for, human applications.

TABLE OF CONTENTS

| | |
|---|----------------|
| Introduction | 3 |
| Key Features | 4 |
| Operating Instructions | 4 – 16 |
| What's in the case | 4 – 5 |
| Setup | 6 – 8 |
| Calibrating a pH Electrode | 8 – 9 |
| Calibrating the Conductivity/ TDS/Salt Probe | 10 |
| Calibrating an Oxygen Probe | 10 – 11 |
| Normal Operation | 12 – 14 |
| Holding and Storing Measurements | 15 |
| Automatic vs. Manual Datalogging | 15 – 16 |
| Transferring Data from the SD Card to a Computer | 16 |
| Specifications | 17 |
| Maintenance & Troubleshooting Tips | 18 |
| Optional Accessories | 18 |

INTRODUCTION

Thank you for purchasing Omega's HHWT-SD1 pH, ORP, Conductivity, TDS, Salt and DO Meter with Datalogging SD Card. Please read this user's manual carefully and thoroughly before using the instrument.

The HHWT-SD1 is a general purpose handheld instrument capable of measuring the pH, oxidation-reduction potential (ORP) or conductivity of a solution, as well as its TDS (total dissolved solids), DO (dissolved oxygen) or salt content. Using an included conductivity/TDS/salt probe, an optional DO probe, and optional ORP and pH electrodes, the meter can measure pH from 0 to 14, ORP from -1999 mV to +1999 mV, conductivity up to 200 mS (milliSiemens), TDS up to 132,000 ppm, DO up to 20 mg/L, and salt content up to 12% by weight.

The meter also accepts an optional automatic temperature compensation (ATC) probe that configures a pH electrode to measure solutions at temperatures between 32° and 150°F (0° and 65°C). For measuring the pH of solutions at temperatures between 32° and 212°F (0° and 100°C), the temperature compensation can be set manually. pH electrodes must be calibrated for pH 4, pH 7 and pH 10 using buffer solutions, as do conductivity/TDS/salt probes and oxygen probes using their own standard solutions.

Among the applications and environments suitable for the HHWT-SD1 are water conditioning, wastewater monitoring, beverage production, aquaculture (fish farming), aquariums, pulp and paper processing, electroplating, and photography.

The HHWT-SD1 has the performance and features needed to satisfy the most demanding aspects of the above applications. A front-panel pushbutton enables rapid switching among the meter's four measurement modes.

Because it is microprocessor-based, the HHWT-SD1 can make full use of the portability, reliability and large storage capacities that SD memory cards offer. Measurements can be made automatically at any sampling rate between one second and nine hours. After time-stamping and storing the measurements on an SD card plugged into the meter (a process called datalogging), the user can remove the card and plug it into to a laptop or desktop computer either directly or via a USB card reader. The data logs are stored on the card as files with the .xls extension, which can be opened by Microsoft's Excel application

The HHWT-SD1 has a backlit 2-1/2 in. diagonal display and is powered by six "AA" Alkaline batteries or an optional 9-VDC AC adapter.

KEY FEATURES

- Measures pH, ORP and conductivity, and TDS, salt and DO content using included and optional electrodes and probes
- Measured parameter can be changed by pressing front-panel buttons
- DO measurements can be compensated for salt, altitude and temperature
- Also measures oxygen content of a volume of air
- Optional ATC probe automatically temperature-compensates pH electrode
- Displays maximum and minimum readings
- Performs real-time automatic datalogging at sampling time settable from 1 second to 9 hours
- Also supports manual logging and changing of card storage location
- Outputs Excel-compatible data logs
- Accepts SD memory cards of up to 16 GB capacity
- Big (2.5 in. diagonal) front-panel green backlit LCD is easy to read
- Auto power off function
- Powered by six “AA” batteries or optional 9V AC/DC adapter

OPERATING INSTRUCTIONS

WHAT'S IN THE CASE

The HHWT-SD1 comes fully assembled in a hard carrying case along with a conductivity/TDS/salt probe, a 2 GB SD card and this user's manual.

Optional accessories available from Omega include:

- pH and ORP electrodes
- A probe for automatic temperature compensation (ATC) of pH electrodes
- A DO probe
- pH 4 and pH 7 buffer solutions
- A 1.413 uS (microSiemens) standard conductivity solution
- A probe-filling electrolyte
- A spare DO probe and diaphragm set
- A 9VDC adapter for a 110V power supply

See the Optional Accessories section of this manual for more details.

Figure 1 shows all of the controls and indicators on the front, back, top, bottom and right side of the HHWT-SD1. Familiarize yourself with the positions and functions of these controls, indicators and connectors before moving on to the setup procedure.

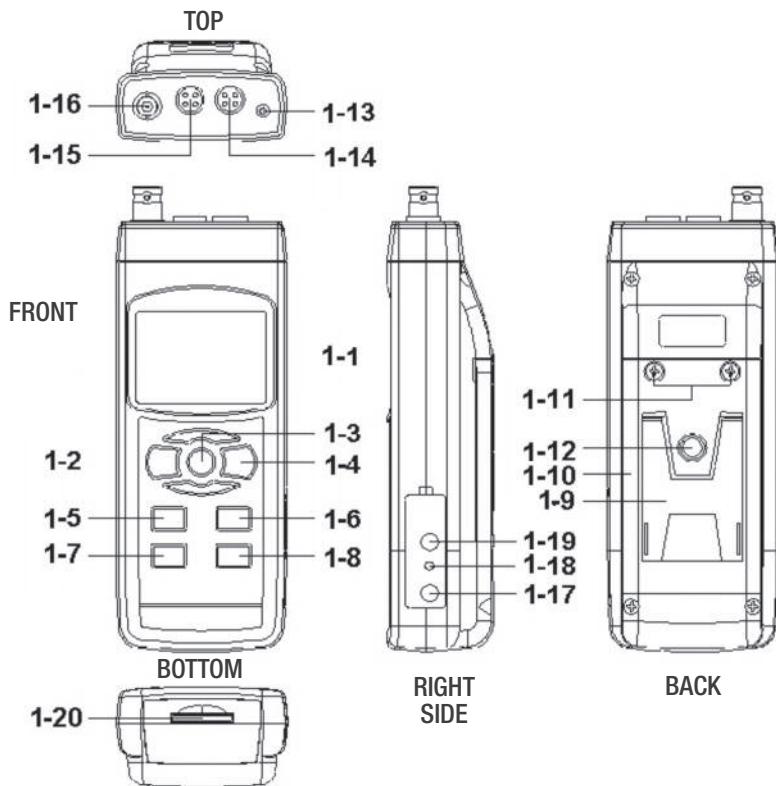

Fig. 1. The HHWT-SD1's controls and indicators and other physical features

- 1-1 Liquid-crystal display
- 1-2 POWER button
- 1-3 HOLD/ESC button
- 1-4 REC/ENTER button
- 1-5 ▲ button
- 1-6 ▼ button
- 1-7 TIME button
- 1-8 LOGGER SET button
- 1-9 Kickstand
- 1-10 Battery compartment cover
- 1-11 Battery compartment cover screws
- 1-12 Tripod attachment nut
- 1-13 Socket for ATC temperature probe
- 1-14 Socket for oxygen probe
- 1-15 Socket for conductivity/TDS/salt probe
- 1-16 Socket for pH electrode with BNC connector
- 1-17 Socket for 9VDC AC adapter
- 1-18 Reset button
- 1-19 RS-232 output jack
- 1-20 SD card socket

SETUP

1. Choose the power source. Before using the HHWT-SD1, be sure it is powered by fresh batteries or an optional 9VDC AC adapter plugged into the bottom jack on its right side (callout 1-15).

To remove the battery compartment cover, remove the two screws holding it in place (callout 1-11). Then install six “AA” batteries in the correct orientation, using the polarity marks on the inside of the compartment as a guide. Replace the cover by replacing the two screws.

2. Install an SD card. To prepare for setup, also install the supplied 2 GB SD memory card or another card with a capacity from 1 GB to 16 GB capacity in the socket on the bottom of the meter (callout 1-18). When installing the card, make sure its gold contacts are facing front and push the card into the socket until you hear a click. To remove the card, push it in until you hear a click and the card pops out.

Now power on the instrument by pressing the POWER button (callout 1-2) to generate a short beep. (To power off the HHWT-SD1 press the POWER button and hold it until the instrument responds with a long beep.)

When the meter powers on, a series of transient startup screens will briefly appear. Once the display has stabilized, perform the following 13 setup steps in the order presented.

3. Format the SD card. The first step in the setup procedure determines whether or not to format the SD memory card plugged into the instrument. Press the LOGGER SET button (callout 1-8) and hold it for at least five seconds, until “Sd-F” appears in the lower half of the display. Quickly (within three seconds) press the REC/ENTER button.

(If you press buttons too slowly in setup mode, the screen will revert to the normal display. To return to the setup sequence, press and hold the LOGGER SET button again. To move ahead to the next field in the sequence or to the next parameter, press the HOLD/ESC button.)

Pressing the REC/ENTER button causes the word “no” or “yES” to appear over the term “Sd-F”. Press the ▼ button to make a selection. Choose “yES” whenever a new SD card is being used, or when a used card is being repurposed (from use with another SD card instrument or a camera, for example) and all data on it is to be erased. Choose “no” to preserve any data on a card previously used with this instrument.

If you choose “yES”, after you press the REC/ENTER button the instrument will prompt you to confirm that decision by displaying the term “Ent” below “yES” and sounding three beeps. To confirm that you want to begin the erasure/formatting procedure, press the REC/ENTER button. “Ent” will then flash several times and the meter will sound another three beeps to confirm that the SD card has been erased and formatted.

4. Set the date and time. Once the SD card has been formatted, the meter will automatically move to the next step in the startup sequence: setting the current date and time. When the word “dAtE” appears in the center of the display, along with the flashing value “00.00.00” at the lower left, above “yy.mm.dd”, set the current year by pressing the ▼ or ▲ button repeatedly until the correct value appears above “yy”. Press the REC/ENTER button to store the setting. The next screen that appears will have the value

above “mm” flashing. Use the ▼ or ▲ button to navigate to the current month and press the REC/ENTER button to store the setting. When the next screen flashes the value above “dd”, again use the ▼ or ▲ button to navigate to the current day and press the REC/ENTER button to store the setting.

Once you have set the date, the display will prompt you to set the hour, minute and second of the current time. Again use the ▼ or ▲ buttons to navigate to the correct values, and the REC/ENTER button to store the settings.

- 5. Set the datalogging sampling time.** Once the date and time have been set and stored, the display will show a value below the letters “SP-t”. Press the ▼ or ▲ button to decrease or increase the flashing hour value until the desired number appears below “SP-t”. Press the REC/ENTER button to store that setting. The minutes value will then flash. Press the ▼ or ▲ button to decrease or increase the value and then press the REC/ENTER button to store that setting. Finally, press the ▼ or ▲ button to decrease or increase the flashing seconds value and then press the REC/ENTER button to store that setting.
- 6. Enable or disable auto power off.** Once the sampling time has been set and stored, the display will show the word “yES” over the term “PoFF”. Press the ▼ button until the desired automatic power off management scheme (“yES” for enable; “no” for disable) is displayed. Press the REC/ENTER button to store the selection. If enabled, the power off function shuts off the HHWT-SD1 after a period of inactivity of ten minutes.
- 7. Enable or disable the beeper.** Once the auto power off scheme has been chosen and stored, the display will show the word “yES” over the word “bEEP”. Press the ▼ button until the desired setting (“yES” or “no”) is displayed, and then press the REC/ENTER button to store the selection as the default.
- 8. Choose a decimal point or comma.** Once the beep sound has been enabled or disabled, the display will show the word “bASIC” above the phrase “dEC”. The next step in the setup sequence determines whether displayed values use a period or a comma to represent the decimal division between integers and fractions (for example, American-style 20.88 vs. European-style 20,88). Press the ▼ button to make “bASIC” (American style) or “Euro” appear in the upper display, as desired. Press the REC/ENTER button to store the selection as the default.
- 9. Select the temperature unit.** Once the format of decimal point divisions has been set and stored, the lower portion of the display will show the term “t-CF”. Press either the ▼ or ▲ button to change the letter displayed at the right of the display to “C” (for Celsius units) or “F” (for Fahrenheit units), as desired. Then press the REC/ENTER button to store the selection as the default.
- 10. Set the optional DO probe’s level of compensation for salt in the solution** when operating in DO measurement mode. The default value is 0% by weight. The level of compensation is adjustable between 0 and 50%. Once the display temperature unit has been set and stored, the lower portion of the display will show the term “SALT”. Press either the ▼ or ▲ button repeatedly until the value above “SALT” matches the desired compensation level. Press the REC/ENTER button to store the setting.

- 11. Compensate for altitude in metric units** when operating in DO measurement mode. The default value is 0 meters (sea level). The level is adjustable from 0 to 8,900 meters. Once the salt compensation level has been set and stored, the lower portion of the display will show the term “High-”. Press the ▼ or ▲ button repeatedly until the value above “High-” reflects your altitude in meters. Press the REC/ENTER button to store the setting.
- 12. Compensate for altitude in English units** when operating in DO measurement mode. The default value is 0 ft (sea level). The level is adjustable from 0 to 29,200 ft. Once the altitude compensation level in meters has been set and stored, the lower portion of the display will show the term “High”. Press the ▼ or ▲ button repeatedly until the value above “High” reflects your altitude in feet. Press the REC/ENTER button to store the setting.
- 13. Compensate the conductivity/TDS/salt probe for temperature.** The default value is 2% per degree C. The value is adjustable from 0 to 5% per degree C. Once the altitude compensation level in feet has been set and stored, the lower portion of the display will show the term “Per C”. Press the ▼ or ▲ button repeatedly until the value above “Per C” matches the desired temperature compensation level. Press the REC/ENTER button to store the setting.
- 14. Choose conductivity (uS or mS) or TDS (ppm) units.** Once the temperature compensation level in conductivity measurement mode has been set and stored, the lower portion of the display will show the term “tDs”. Press the ▼ or ▲ button until either the term “Cd” or “tdS” appears above it. Then press the REC/ENTER button to store the setting as the default.
- 15. Set the compensation temperature for the pH electrode** when the meter is operating in pH measurement mode without an ATC probe. The default value is 77°F (25°C). The compensation temperature can be set anywhere between 32° and 212°F (0° and 100°C). Once the units of conductivity measurements have been set and stored, the lower portion of the display will show the term “t-Set”. Press the ▼ or ▲ button repeatedly until the value above “t-Set” matches the desired compensation temperature. Press the REC/ENTER button to store the setting.

The display will then either return to the first of the 13 steps in the setup sequence—choosing whether or not to format the SD memory card—or show the term “ESC”. If “ESC” appears, press either the HOLD/ESC button or the LOGGER SET button to exit the setup procedure and enter normal operating mode.

CALIBRATING A pH ELECTRODE

The optional pH electrode you are using must be calibrated before making pH measurements with it for the first time. The electrode also should be calibrated whenever you wish to maximize the accuracy of measurements. Calibration is necessary because not every pH electrode is an “ideal” electrode that generates 0 mV at pH 7 and 177.4 mV at pH 4.

To calibrate a pH electrode, perform the following procedure while referring to Figure 2:

Fig. 2. Calibrating a pH electrode using the buffer solution

- 2-1 Electrode plug
- 2-2 Electrode handle
- 2-3 Electrode head
- 2-4 pH buffer solution

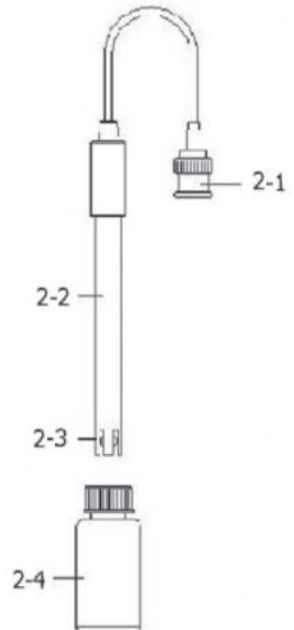

1. Insert the plug of a pH electrode into the BNC socket at the top of the meter (callout 1-16 of Fig. 1).
2. Power on the meter by pressing the POWER button.
3. Using Step 15 of the setup procedure, manually adjust the compensation temperature so it matches the temperature of the buffer solution. Alternatively, use an ATC temperature probe to make the adjustment automatically.
4. Holding the electrode by its handle, immerse it in the bottle of buffer solution. (If you are using the ATC temperature probe, immerse its head in the bottle as well.)
5. Gently shake the electrode (and the probe, if used). The display will show the pH value.

6. Use two fingers to press the REC/ENTER and HOLD/ESC buttons at the same time. When this screen appears, release the buttons.

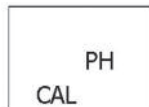

7. Press the ▼ or ▲ button until this screen appears. Press the REC/ENTER button to calibrate the electrode for pH 7.

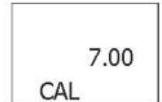

8. Press the ▼ or ▲ button again until this screen appears. Press the REC/ENTER button to calibrate the electrode for pH 4.

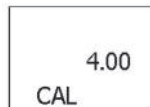

9. Press the ▼ or ▲ button again until this screen appears. Press the REC/ENTER button to calibrate the electrode for pH 10.

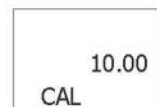

10. The pH electrode has now been calibrated once. To maximize measurement accuracy, Omega recommends rinsing the head of the electrode (and the head of the ATC temperature probe, if used) in distilled water and then repeating the above steps at least twice more.

11. To recalibrate the electrode in the future, you must clear the existing settings. To do so, press the ▼ or ▲ button until this screen appears. Then press the REC/ENTER button to clear the saved settings before repeating the steps above to calibrate the electrode for pH 7, pH 4 and pH 10.

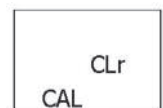

CALIBRATING THE CONDUCTIVITY/TDS/SALT PROBE

The following procedure is sufficient to calibrate the supplied conductivity/TDS/salt probe so it accurately measures all three parameters.

- 1. Obtain the correct standard** conductivity solution(s) for the full-scale range(s) you expect to use. For example, if you expect to measure conductivity values using a full-scale range of 2 mS, use a 1.413 mS standard conductivity solution. For measurements within the 200 μ S full-scale range, obtain and use an 80 μ S standard solution.
- 2. Plug the probe into its dedicated socket** on the top of the meter (callout 1-15 of Fig. 1). Then power on the meter and push the ▼ button (which has the word “MODE” stenciled above it) until the display shows the term “Cd”.
- 3. To perform the calibration, immerse and shake the head of the probe** in the standard solution. The display will show its conductivity in units of μ S or mS.
- 4. Once a value is displayed**, use two fingers to press the REC/ENTER and HOLD/ESC buttons simultaneously.
- 5. When this screen appears**, release both fingers. Then press the REC/ENTER button. The display will then switch into a two-level (upper and lower) mode that looks like this:

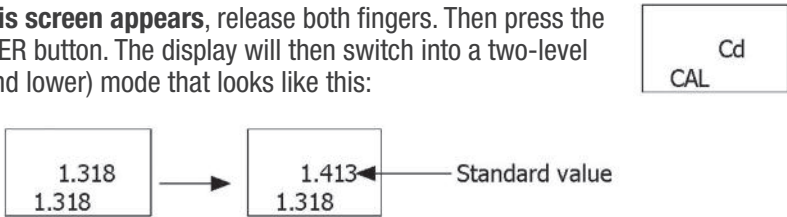

- 6. Press the ▼ or ▲ button** to raise or lower the measured value until it matches the standard conductivity value.
- 7. Complete the calibration procedure** by pressing the REC/ENTER button.

If you expect to make conductivity readings using other full-scale ranges, you should repeat this calibration procedure using other standard conductivity solutions of appropriate strength. If you do, Omega advises performing the above procedure (for a 2-mS full-scale range) first.

CALIBRATING AN OXYGEN PROBE

An optional oxygen probe must be calibrated before you use it for the first time, and again after a long period (weeks or months) of sitting idle. Omega also recommends calibrating an oxygen probe before making any measurements that must be extremely precise.

Before beginning the calibration procedure, make sure that the oxygen probe is full of fresh electrolyte. Use the following steps—while referring to Fig. 3 below—either to fill the probe with electrolyte or to replace old electrolyte with fresh electrolyte.

1. Unscrew the probe head from the probe handle
2. Empty and dispose of any residual electrolyte from the probe head’s reservoir
3. Pour fresh electrolyte into the reservoir
4. Screw the probe head back into the probe body

Fig. 3. How to fill an oxygen probe's head with electrolyte

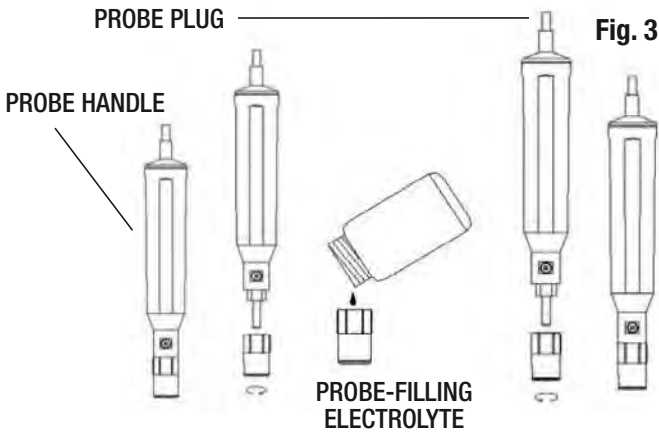

To calibrate an oxygen probe, use the following procedure while referring to Figures 1 and 4.

Fig. 4. An oxygen probe's main components

- 4-1 — Probe plug
- 4-2 — Probe handle
- 4-3 — Temperature-sensing metal
- 4-4 — Probe cap
- 4-5 — Probe head protective cover

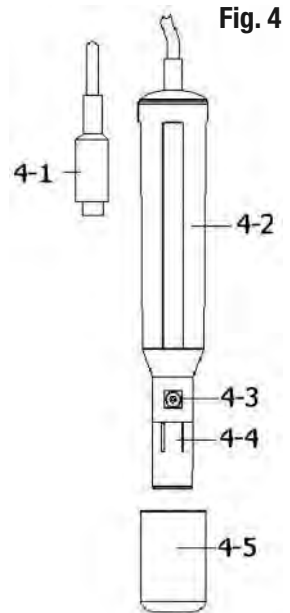

- 1. Plug the probe plug into the DO probe socket** (callout 1-14 of Fig. 1) on the top of the meter.
- 2. Power on the instrument** by pressing the POWER button on the front panel.
- 3. Press the ▲ button** (which has the word “MODE” stenciled above it) until the display shows the term “do”.
- 4. Press the ▼ button** (which has the word “Function” stenciled above it) to switch the unit shown on the display from “mg/L” to “%O₂”.
- 5. Wait at least five minutes** until the display readings stabilize.
- 6. Use two fingers to press the "REC/ENTER" and HOLD/ESC buttons** at the same time.
- 7. Release your fingers once this screen appears** (indicating that air typically has an oxygen content of 20.9%).

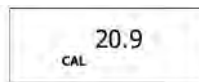

- 8. Press the REC/ENTER button.** The display will then count down from 30 seconds to 0.
- 9. When the countdown is complete, press the ▼ button once** to return to the normal display of “mg/L”.

NORMAL OPERATION

The HHWT-SD1 can operate in any of four measurement modes, selectable by pressing the ▼ button (which has the word “Function” stenciled above it). Pressing the button repeatedly cycles through the modes and produces the following on-screen text:

- PH (for measuring the pH or ORP of a solution)
- Cd (for conductivity and TDS measurements)
- SALt (for measuring the salt content of a solution by weight)
- do (for dissolved oxygen measurements)

1. To select the measurement mode, press the ▼ button (which has the word “Function” stenciled above it) repeatedly until the term for the desired measurement mode appears.

2. To measure the pH of a solution, power on the meter and press the ▼ button until the display shows the term “PH”. Obtain a pH electrode and seat it firmly in the BNC socket (callout 1-16 of Fig. 1) on the top of the meter. If an ATC temperature probe is being used, make sure it is seated firmly in its socket (callout 1-13 of Fig. 1) on the top of the meter as well. If an ATC probe is not being used, perform Step 15 of the setup procedure to manually match the compensation temperature to the temperature of the solution being tested.

Following are the default states for the HHWT-SD1 in pH measurement mode:

- The display shows “PH”
- Temperature unit of °C
- Manual temperature compensation
- Auto power off
- Sampling time of 2 seconds

To change any of these parameters, use the specific procedure for it detailed earlier in the Setup section.

To make the pH measurement, hold the pH electrode by its handle and immerse it in the solution under test. (If you are using the ATC temperature probe, immerse its head in the solution as well.) Gently shake the electrode (and probe, if used) to help any air bubbles escape and to ensure an accurate reading. The display will simultaneously show the solution’s pH in the center and either the manually selected compensation temperature or the actual temperature of the solution (as measured by the ATC probe) below it. By default, the temperature reading will be in °C, unless °F has been selected.

3. To measure the ORP of a solution, power on the meter and make sure that it is operating in pH measurement mode. Then press the ▼ or ▲ button to make the display show the term “mV”. Next, obtain an ORP electrode with a BNC connector and plug it into the same socket on the top of the meter (callout 1-16 of Fig. 1) that accepts the plug of a pH electrode. Holding the ORP electrode by its handle, immerse it in the solution under test. Gently shake the head of the electrode to help any air bubbles escape and to ensure an accurate reading. The display will show the ORP of the solution, in mV.

4. To measure the conductivity of a solution, power on the meter and press the ▼ button until the display shows the term “Cd”. Plug the conductivity/TDS/salt probe into its dedicated socket (callout 1-15 of Fig. 1) on the top of the meter.

Following are the default states for the HHWT-SD1 in conductivity measurement mode:

- The display shows “Cd”
- Temperature unit of °C
- Temperature compensation factor of 2% per °C
- Autoranging on
- Auto power off
- Sampling time of 2 seconds

To change any of these parameters, use the specific procedure for it detailed in the Setup section. To exit autoranging mode and manually enter a full-scale measurement range, press the ▼ button (which has the word “RANGE” stenciled below it) repeatedly until the desired range appears. The options are 200 uS, 2 mS, 20 mS and 200 mS. If the display shows a reading other than zero before the probe is inserted in the solution to be tested, press the ▲ button and hold it for at least 10 seconds until the display reads zero (this zeroing function only works in the 200 uS full-scale range and only when the original non-zero value that appears is less than 2 uS).

To make the conductivity measurement, hold the conductivity probe by its handle and immerse it in the solution under test. Gently shake the head of the probe to help any air bubbles escape and to ensure an accurate reading. The display will show both the conductivity of the solution in uS or mS and its temperature.

5. To measure the TDS content of a solution, power on the meter and press the ▼ button until the display shows the term “Cd”, indicating operation in conductivity measurement mode. Then press the ▼ or ▲ button until the term “tdS” appears. Next, press the REC/ENTER button to store the setting as the temporary default. Finally, plug a conductivity/TDS/salt probe into its dedicated socket (callout 1-15 of Fig. 1) on the top of the meter.

To make the TDS measurement, hold the conductivity probe by its handle and immerse it in the solution under test. Gently shake the head of the probe to help any air bubbles escape and to ensure an accurate reading. The display will show both the TDS of the solution in uS or mS and its temperature.

6. To measure the salt content of a solution, power on the meter and press the ▼ button until the display shows the term “Cd”, again indicating operation in conductivity measurement mode. Then press the ▼ or ▲ button until the term “SALT” appears. Next, press the REC/ENTER button to store the setting as the temporary default.

To make the salt content measurement, hold the conductivity probe by its handle and immerse it in the solution under test. Gently shake the head of the probe to help any air bubbles escape and to ensure an accurate reading. The display will show the salt content of the solution as a % by weight value.

7. To measure the DO content of a liquid, power on the meter and press the ▼ button until the display shows the term “do”, indicating operation in DO measurement mode. Then—after making sure that the optional oxygen probe you have obtained is full of fresh electrolyte and has been recently calibrated—remove the protective cover from the probe head and plug the probe into its dedicated socket on the top of the meter (callout 1-14 of Fig. 1).

To make the DO content measurement, do the following:

- 1. Insert the probe** at least 4 in. (10cm) into the liquid to be measured
- 2. Wait a few minutes** for the instrument to automatically compensate for any difference in temperature between the probe and the liquid
- 3. Read the DO content** of the liquid in mg/L on the upper display and its temperature on the lower display
- 4. Rinse the probe head** with tap water after each measurement
- 5. Replace the probe head protection cover**

A DO measurement tip

Agitating a liquid reduces the effect of measurement errors caused by oxygen diffusing into it from ambient air. At a minimum, this can be done by shaking the probe while it is immersed. To minimize measurement errors of this type, Omega recommends using a magnetic agitator, especially in laboratory settings.

8. To measure the oxygen content of a volume of air, first make sure that the oxygen probe to be used is full of fresh electrolyte and recently calibrated. Power on the meter and press the ▼ button until the display shows the term “do”, indicating operation in DO measurement mode. Then press the ▼ button again to make the display read “%O2” instead of “mg/L”. Wait at least five minutes until the display reading stabilizes. To return to “mg/L” readings, press the ▼ button again.

Whenever the HHWT-SD1 is in any measurement mode, you can turn off the backlight (which is on by default) by briefly pressing (but not holding) the POWER/ESC button. To reactivate the backlight, briefly press the button again.

Whenever the instrument is in any measurement mode, you also can check the current date and time by briefly pressing the TIME button. Doing so causes both values to appear briefly at the lower left of the display.

HOLDING AND STORING MEASUREMENTS

- 1. To hold a measured value of any parameter**, press the HOLD/ESC button during the measurement. Doing so will cause the word “HOLD” to appear at the top of the display. Pressing the HOLD/ESC button again releases the hold.
- 2. To record and recall readings**, press the REC/ENTER button while making measurements. This will make the term “REC” appear at the top of the display. Pressing the REC/ENTER button again, briefly, will make the term “MAX” appear to the right of “REC” and switch the display to the maximum value stored in memory during the last recording session. Pressing the REC/ENTER button again, briefly, will make the term “MIN” appear to the right of “REC” and switch the display to the minimum value stored during the last session.
- 3. To exit recording mode**, press and hold the REC/ENTER button for at least three seconds, until the term “REC” disappears from the top line of the display. The display will then revert to showing the current reading.

AUTOMATIC VS. MANUAL DATALOGGING

The HHWT-SD1 can automatically log data at a user-selected sampling period from 1 second to 9 hours. To view the sampling time that the instrument has been set up to use, press the LOGGER SET button (which has the words “Sampling check” stenciled below it) once. To change the sampling time, perform Step 5 of the setup procedure.

- 1. To start automatic datalogging**, press the REC/ENTER button once. The top line of the display will then show the term “REC”. Pressing the LOGGER SET button at this point will make REC flash and add the flashing term “LOGGER” at the top right of the display. This indicates that the instrument is currently storing measured values and their time stamps in memory.
- 2. To pause automatic datalogging**, press the LOGGER SET button once; this action makes the flashing term LOGGER disappear from the top right of the display and changes the term “REC” from flashing to constant. Pressing the LOGGER SET button again resumes automatic datalogging.
- 3. To end automatic datalogging**, press the REC/ENTER button and hold it for at least two seconds. This action causes the “REC” message to disappear.
- 4. To log data manually**, set the sampling time to zero using the procedure detailed earlier. Then press the REC/ENTER button once. The display will show the term “REC” on the top line, a value in the middle, and below it the letter “P” on the left and a number from 1 to 99 on the same line to the right. The number indicates the position on the SD card that will be used to store manually logged data.

Now press the LOGGER SET button. This will cause the beeper to sound and the term “LOGGER” to briefly appear at the upper right of the display. As in automatic datalogging mode, in this mode the instrument is storing measurements and their time stamps on the SD card.

In manual datalogging mode, however, measurements are being stored continuously (with a sampling time of zero), and their locations on the card can be changed.

5. To change the storage location of manually logged data, press the ▼ button once; this causes the “P” to disappear from the left side of the display and the value on its line to begin flashing. Once the flashing begins, you can use the ▼ and ▲ buttons to change the flashing value to any number between 1 and 99. Once you have chosen the storage location, press the REC/ENTER button to save the setting. This causes the value to stop flashing and the “P” to return.

6. To end manual datalogging, press the REC/ENTER button and hold it for at least three seconds. This action causes the “REC” message to disappear from the top line of the display.

TRANSFERRING DATA FROM THE SD CARD TO A COMPUTER

After automatic or manual datalogging of measurements, remove the SD card from the meter and plug it into your computer either directly (if it has an SD card slot) or through an SD card reader.

Because the files containing time-stamped data logs have the file extension .xls, they open in Microsoft’s Excel application.

Figures 5, 6 and 7 show three kinds of Excel presentations: a data-only screen, a graphics-only screen, and a mixed data/graphics screen.

| | A | B | C | D | E | F | G |
|----|----------|-----------|----------|-----------|----------|-----------|----------|
| 1 | Position | Date | Time | Ch1 Value | Ch1 Unit | Ch2 Value | Ch2 Unit |
| 2 | 1 | 2009/8/12 | 13:16:36 | 73.1 | uS | 24.7 | Degree_C |
| 3 | 2 | 2009/8/12 | 13:16:38 | 73.2 | uS | 24.7 | Degree_C |
| 4 | 3 | 2009/8/12 | 13:16:40 | 73.2 | uS | 24.7 | Degree_C |
| 5 | 4 | 2009/8/12 | 13:16:42 | 73.2 | uS | 24.7 | Degree_C |
| 6 | 5 | 2009/8/12 | 13:16:44 | 73.4 | uS | 24.7 | Degree_C |
| 7 | 6 | 2009/8/12 | 13:16:46 | 73.5 | uS | 24.7 | Degree_C |
| 8 | 7 | 2009/8/12 | 13:16:48 | 73.4 | uS | 24.7 | Degree_C |
| 9 | 8 | 2009/8/12 | 13:16:50 | 73.4 | uS | 24.7 | Degree_C |
| 10 | 9 | 2009/8/12 | 13:16:52 | 73.5 | uS | 24.7 | Degree_C |
| 11 | 10 | 2009/8/12 | 13:16:54 | 73.3 | uS | 24.7 | Degree_C |
| 12 | 11 | 2009/8/12 | 13:16:56 | 73.2 | uS | 24.7 | Degree_C |
| 13 | 12 | 2009/8/12 | 13:16:58 | 73.2 | uS | 24.7 | Degree_C |

Fig. 5. Typical Excel data-only screen

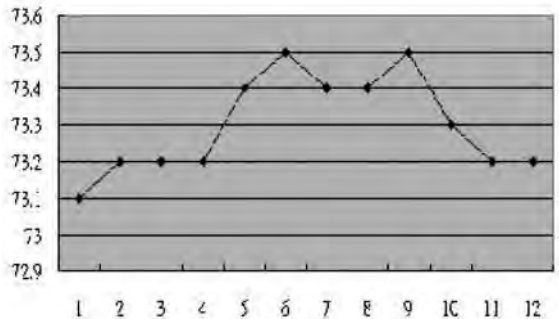

Fig. 6. Typical Excel graphics-only screen

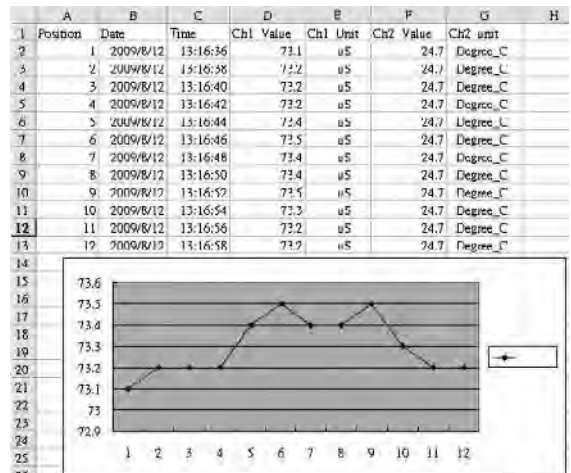



Fig. 7. Typical Excel mixed data/graphics screen

SPECIFICATIONS

| | |
|------------------------------|---|
| Embedded microcontroller | Custom one-chip LSI device |
| Display type | Liquid-crystal with green backlight |
| Display size | 2.05 x 1.5 in. (52 x 38mm) |
| Parameters measured | pH, ORP, conductivity, TDS, DO content, salt content |
| Measurement range | 0 to 14 for pH; -1999 mV to +1999 mV for ORP; conductivity up to 200 mS (milliSiemens); TDS up to 132,000 ppm; DO up to 20 mg/L; salt content up to 12% by weight. |
| Measurement accuracy | \pm (0.02 pH units + 2 digits) for pH; \pm (0.5% of reading + 2 digits) for ORP; \pm 2% of full-scale reading + 1 digit for conductivity and TDS; \pm 0.8°C/ \pm 1.5°F for temperature; \pm 0.4 mg/L for DO in solution and 0.1% for oxygen in air; \pm 0.5% of value for salt |
| Measurement resolution | 0.01 unit for pH; 1 mV for ORP; for conductivity: 0.1 uS @ 200 uS full-scale (f.s.), 0.001 mS @ 2 mS f.s., 0.01 mS @ 20 mS f.s., 0.1mS @ 200 mS f.s.; for TDS: 0.1 ppm @200 ppm f.s., 1 ppm @2,000 ppm f.s., 10 ppm @ 20,000 ppm f.s., 100 ppm @ 100,000 ppm f.s.; 0.1°F/0.1°C for temperature; 0.1 mg/L for DO in solution and 0.1% for oxygen in air; 0.01% of reading for salt |
| Temperature compensation | Automatic between 32° and 150°F (0° and 65°C) when using optional ATC temperature probe; manually settable between 32° and 212°F (0° and 100°C) without ATC probe |
| Storable/recallable readings | Maximum, minimum |
| Datalogging sampling time | Settable between 1 second and 8 hours, 59 minutes, 59 seconds (in automatic datalogging mode) |
| SD card capacity | 1 GB to 16 GB |
| Settable parameters | Date, time, auto power off, beep sound, sampling time, decimal point or comma decimal division, temperature unit, compensation temperature. Also salt and altitude compensation (DO mode only) |
| Operating temperature | 32° to 122°F (0° to 50°C) |
| Operating relative humidity | 0 to 85% |
| Power source | 6 Alkaline “AA” batteries or optional 9-VDC AC adapter |
| Power consumption | 14 mADC (normal operation, with backlight off and SD card not saving data); 37 mADC with backlight on and card saving data; 49 mADC with backlight on and card saving data |
| Dimensions of meter | 6.97 x 2.68 x 1.77 in. (177 x 68 x 45mm) |
| Weight of meter | 1.08 lb. (489g) |

MAINTENANCE & TROUBLESHOOTING TIPS

Keep all probes and electrodes clean and protected from the elements when not in use. When a pH electrode is not being used, Omega recommends keeping its head inserted in the bottle of pH buffer solution.

When the icon  appears in the left corner of the display, it's time to replace the six "AA" batteries that power the instrument (although measurements will remain valid for several hours after the low-battery indicator first appears). Replacing the batteries requires removing the two screws that hold the battery compartment cover in place, in Step 1 of the setup procedure on page 6. After inserting fresh batteries in the correct orientation, tighten the screws to secure the cover.

If the meter "freezes" (like a computer) and buttons become unresponsive, try resetting the instrument by pushing the RESET button on its right side (callout 1-15 of Fig. 1) with the end of a paper clip.

Remove the batteries when storing this product for an extended period of time.

Do not drop or disassemble the instrument or immerse it in water.

OPTIONAL ACCESSORIES

- pH electrodes
- pH 4, pH 7 and pH 10 buffer solutions
- ORP electrode
- DO probe
- DO probe-filling electrolyte
- Spare DO probe and diaphragm set
- ATC temperature probe
- 9-VDC adapter for a 110VAC power supply

WARRANTY/DISCLAIMER

OMEGA ENGINEERING, INC. warrants this unit to be free of defects in materials and workmanship for a period of **13 months** from date of purchase. OMEGA's WARRANTY adds an additional one (1) month grace period to the normal **one (1) year product warranty** to cover handling and shipping time. This ensures that OMEGA's customers receive maximum coverage on each product.

If the unit malfunctions, it must be returned to the factory for evaluation. OMEGA's Customer Service Department will issue an Authorized Return (AR) number immediately upon phone or written request. Upon examination by OMEGA, if the unit is found to be defective, it will be repaired or replaced at no charge. OMEGA's WARRANTY does not apply to defects resulting from any action of the purchaser, including but not limited to mishandling, improper interfacing, operation outside of design limits, improper repair, or unauthorized modification. This WARRANTY is VOID if the unit shows evidence of having been tampered with or shows evidence of having been damaged as a result of excessive corrosion; or current, heat, moisture or vibration; improper specification; misapplication; misuse or other operating conditions outside of OMEGA's control. Components in which wear is not warranted, include but are not limited to contact points, fuses, and triacs.

OMEGA is pleased to offer suggestions on the use of its various products. However, OMEGA neither assumes responsibility for any omissions or errors nor assumes liability for any damages that result from the use of its products in accordance with information provided by OMEGA, either verbal or written. OMEGA warrants only that the parts manufactured by the company will be as specified and free of defects. OMEGA MAKES NO OTHER WARRANTIES OR REPRESENTATIONS OF ANY KIND WHATSOEVER, EXPRESSED OR IMPLIED, EXCEPT THAT OF TITLE, AND ALL IMPLIED WARRANTIES INCLUDING ANY WARRANTY OF MERCHANTABILITY AND FITNESS FOR A PARTICULAR PURPOSE ARE HEREBY DISCLAIMED. LIMITATION OF LIABILITY: The remedies of purchaser set forth herein are exclusive, and the total liability of OMEGA with respect to this order, whether based on contract, warranty, negligence, indemnification, strict liability or otherwise, shall not exceed the purchase price of the component upon which liability is based. In no event shall OMEGA be liable for consequential, incidental or special damages.

CONDITIONS: Equipment sold by OMEGA is not intended to be used, nor shall it be used: (1) as a "Basic Component" under 10 CFR 21 (NRC), used in or with any nuclear installation or activity; or (2) in medical applications or used on humans. Should any Product(s) be used in or with any nuclear installation or activity, medical application, used on humans, or misused in any way, OMEGA assumes no responsibility as set forth in our basic WARRANTY/DISCLAIMER language, and, additionally, purchaser will indemnify OMEGA and hold OMEGA harmless from any liability or damage whatsoever arising out of the use of the Product(s) in such a manner.

RETURN REQUESTS/INQUIRIES

Direct all warranty and repair requests/inquiries to the OMEGA Customer Service Department. BEFORE RETURNING ANY PRODUCT(S) TO OMEGA, PURCHASER MUST OBTAIN AN AUTHORIZED RETURN (AR) NUMBER FROM OMEGA'S CUSTOMER SERVICE DEPARTMENT (IN ORDER TO AVOID PROCESSING DELAYS). The assigned AR number should then be marked on the outside of the return package and on any correspondence.

The purchaser is responsible for shipping charges, freight, insurance and proper packaging to prevent breakage in transit.

FOR **WARRANTY** RETURNS, please have the following information available BEFORE contacting OMEGA:

1. Purchase Order number under which the product was PURCHASED,
2. Model and serial number of the product under warranty, and
3. Repair instructions and/or specific problems relative to the product.

FOR **NON-WARRANTY** REPAIRS, consult OMEGA for current repair charges. Have the following information available BEFORE contacting OMEGA:

1. Purchase Order number to cover the COST of the repair,
2. Model and serial number of the product, and
3. Repair instructions and/or specific problems relative to the product.

OMEGA's policy is to make running changes, not model changes, whenever an improvement is possible. This affords our customers the latest in technology and engineering.

OMEGA is a registered trademark of OMEGA ENGINEERING, INC.

© Copyright 2014 OMEGA ENGINEERING, INC. All rights reserved. This document may not be copied, photocopied, reproduced, translated, or reduced to any electronic medium or machine-readable form, in whole or in part, without the prior written consent of OMEGA ENGINEERING, INC.

Where Do I Find Everything I Need for Process Measurement and Control? **OMEGA...Of Course!**

Shop online at omega.comSM

TEMPERATURE

- Thermocouple, RTD & Thermistor Probes, Connectors, Panels & Assemblies
- Wire: Thermocouple, RTD & Thermistor
- Calibrators & Ice Point References
- Recorders, Controllers & Process Monitors
- Infrared Pyrometers

PRESSURE, STRAIN AND FORCE

- Transducers & Strain Gages
- Load Cells & Pressure Gages
- Displacement Transducers
- Instrumentation & Accessories

FLOW/LEVEL

- Rotameters, Gas Mass Flowmeters & Flow Computers
- Air Velocity Indicators
- Turbine / Paddlewheel Systems
- Totalizers & Batch Controllers

pH/CONDUCTIVITY

- pH Electrodes, Testers & Accessories
- Benchtop / Laboratory Meters
- Controllers, Calibrators, Simulators & Pumps
- Industrial pH & Conductivity Equipment

DATA ACQUISITION

- Data Acquisition & Engineering Software
- Communications-Based Acquisition Systems
- Plug-in Cards for Apple, IBM & Compatibles
- Data Logging Systems
- Recorders, Printers & Plotters

HEATERS

- Heating Cable
- Cartridge & Strip Heaters
- Immersion & Band Heaters
- Flexible Heaters
- Laboratory Heaters

ENVIRONMENTAL MONITORING AND CONTROL

- Metering & Control Instrumentation
- Refractometers
- Pumps & Tubing
- Air, Soil & Water Monitors
- Industrial Water & Wastewater Treatment
- pH, Conductivity & Dissolved Oxygen Instruments