

1 YEAR
WARRANTY

OMEGA CARE
Extended Warranty Program

CE

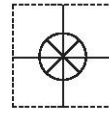

User's Guide

Shop online at

omega.com[®]

ΩOMEGA[®]

omega.com

e-mail: info@omega.com

For latest product manuals:

omegamanual.info



ISO 9001

CERTIFIED
CORPORATE QUALITY

STAMFORD, CT

ISO 9001

CERTIFIED
CORPORATE QUALITY

MANCHESTER, UK

OM-USB-1408FS 14-Bit Multifunction USB Data Acquisition Module



OMEGAnet® Online Service omega.com	Internet e-mail info@omega.com
--	--

Servicing North America:

U.S.A.:
ISO 9001 Certified

Omega Engineering, Inc., One Omega Drive, P.O. Box 4047
Stamford, CT 06907-0047 USA
Toll Free: 1-800-826-6342 TEL: (203) 359-1660
FAX: (203) 359-7700 e-mail: info@omega.com

Canada:

976 Bergar
Laval (Quebec), H7L 5A1 Canada
Toll-Free: 1-800-826-6342 TEL: (514) 856-6928
FAX: (514) 856-6886 e-mail: info@omega.ca

For immediate technical or application assistance:

U.S.A. and Canada: Sales Service: 1-800-826-6342/1-800-TC-OMEGA®
Customer Service: 1-800-622-2378/1-800-622-BEST®
Engineering Service: 1-800-872-9436/1-800-USA-WHEN®

**Mexico/
Latin America:**

En Español: 001 (203) 359-7803 FAX: 001 (203) 359-7807
info@omega.com.mx e-mail: espanol@omega.com

Servicing Europe:

Benelux:

Managed by the United Kingdom Office
Toll-Free: 0800 099 3344 TEL: +31 20 347 21 21
FAX: +31 20 643 46 43 e-mail: sales@omegaeng.nl

Czech Republic:

Frystatska 184
733 01 Karviná, Czech Republic
Toll-Free: 0800-1-66342 TEL: +420-59-6311899
FAX: +420-59-6311114 e-mail: info@omegashop.cz

France:

Managed by the United Kingdom Office
Toll-Free: 0800 466 342 TEL: +33 (0) 161 37 29 00
FAX: +33 (0) 130 57 54 27 e-mail: sales@omega.fr

Germany/Austria:

Daimlerstrasse 26
D-75392 Deckenpfronn, Germany
Toll-Free: 0800 6397678 TEL: +49 (0) 7056 9398-0
FAX: +49 (0) 7056 9398-29 e-mail: info@omega.de

United Kingdom:
ISO 9001 Certified

OMEGA Engineering Ltd.
One Omega Drive, River Bend Technology Centre, Northbank
Irlam, Manchester M44 5BD United Kingdom
Toll-Free: 0800-488-488 TEL: +44 (0) 161 777-6611
FAX: +44 (0) 161 777-6622 e-mail: sales@omega.co.uk

It is the policy of OMEGA Engineering, Inc. to comply with all worldwide safety and EMC/EMI regulations that apply. OMEGA is constantly pursuing certification of its products to the European New Approach Directives. OMEGA will add the CE mark to every appropriate device upon certification.

The information contained in this document is believed to be correct, but OMEGA accepts no liability for any errors it contains, and reserves the right to alter specifications without notice.

WARNING: These products are not designed for use in, and should not be used for, human applications.

Table of Contents

Preface

About this User's Guide	5
What you will learn from this user's guide	5
Conventions in this user's guide	5
Where to find more information	5

Chapter 1

Introducing the OM-USB-1408FS	6
OM-USB-1408FS block diagram	7
Software features	7
Connecting a OM-USB-1408FS to your computer is easy	8

Chapter 2

Installing the OM-USB-1408FS	9
What comes with your OM-USB-1408FS shipment?.....	9
Hardware	9
Additional documentation.....	9
Unpacking the OM-USB-1408FS.....	9
Installing the software	10
Installing the hardware	10
Calibrating the OM-USB-1408FS	10

Chapter 3

Functional Details	11
Theory of operation - analog input acquisition modes	11
Software paced mode	11
Continuous scan mode	11
External components	11
USB connector	12
LED	12
Screw terminal wiring.....	12
Main connector and pin out	13
Analog input terminals (CH0 IN - CH7 IN).....	13
Analog output terminals (D/A OUT 0 and D/A OUT 1).....	16
Digital I/O terminals (Port A0 to A7, and Port B0 to B7).....	16
Power terminals	16
External trigger terminal	17
Counter terminal	17
+2.5VREF terminal.....	17
SYNC terminal	17
Ground terminals	17
Accuracy.....	17
OM-USB-1408FS channel gain queue feature	20
Synchronizing multiple units.....	21

Chapter 4

Specifications	22
Analog input	22
Analog output	24
Digital input/output.....	24
External trigger	25
External clock input/output.....	25
Counter section	25

Non-volatile memory.....	26
Microcontroller.....	26
Power.....	26
General	26
Environmental	27
Mechanical	27
Main connector and pin out	27
4-channel differential mode	27
8-channel single-ended mode.....	28

About this User's Guide

What you will learn from this user's guide

This user's guide explains how to install, configure, and use the OM-USB-1408FS so that you get the most out of its USB data acquisition features.

This user's guide also refers you to related documents available on our web site, and to technical support resources.

Conventions in this user's guide

For more information on ...

Text presented in a box signifies additional information and helpful hints related to the subject matter you are reading.

Caution! Shaded caution statements present information to help you avoid injuring yourself and others, damaging your hardware, or losing your data.

<#:#> Angle brackets that enclose numbers separated by a colon signify a range of numbers, such as those assigned to registers, bit settings, etc.

bold text **Bold** text is used for the names of objects on the screen, such as buttons, text boxes, and check boxes. For example:

1. Insert the disk or CD and click the **OK** button.

italic text *Italic* text is used for the names of manuals and help topic titles, and to emphasize a word or phrase. For example:

Never touch the exposed pins or circuit connections on the board.

Where to find more information

For additional information relevant to the operation of your hardware, refer to the *Documents* subdirectory where you installed the software, or search for your device on our website at www.omega.com.

Introducing the OM-USB-1408FS

This user's guide contains all of the information you need to connect the OM-USB-1408FS to your computer and to the signals you want to measure.

The OM-USB-1408FS is a USB 2.0 full-speed, device that is supported under popular Microsoft® Windows® operating systems. The OM-USB-1408FS is fully compatible with both USB 1.1 and USB 2.0 ports.

The OM-USB-1408FS features eight analog inputs, two 12-bit analog outputs, 16 digital I/O connections, and one 32-bit external event counter.

The analog inputs are software configurable for either eight 13-bit single-ended inputs or four 14-bit differential inputs. The 16 digital I/O lines are independently selectable as input or output in two 8-bit ports. The 32-bit counter can count TTL pulses. A SYNC (synchronization) input/output line allows you to pace the analog input acquisition of one USB module from the clock output of another.

The OM-USB-1408FS is powered by the +5 volt USB supply from your computer. No external power is required.

The OM-USB-1408FS is shown in Figure 1. I/O connections are made to the screw terminals located along each side of the OM-USB-1408FS.



Figure 1. OM-USB-1408FS

OM-USB-1408FS block diagram

OM-USB-1408FS functions are illustrated in the block diagram shown here.

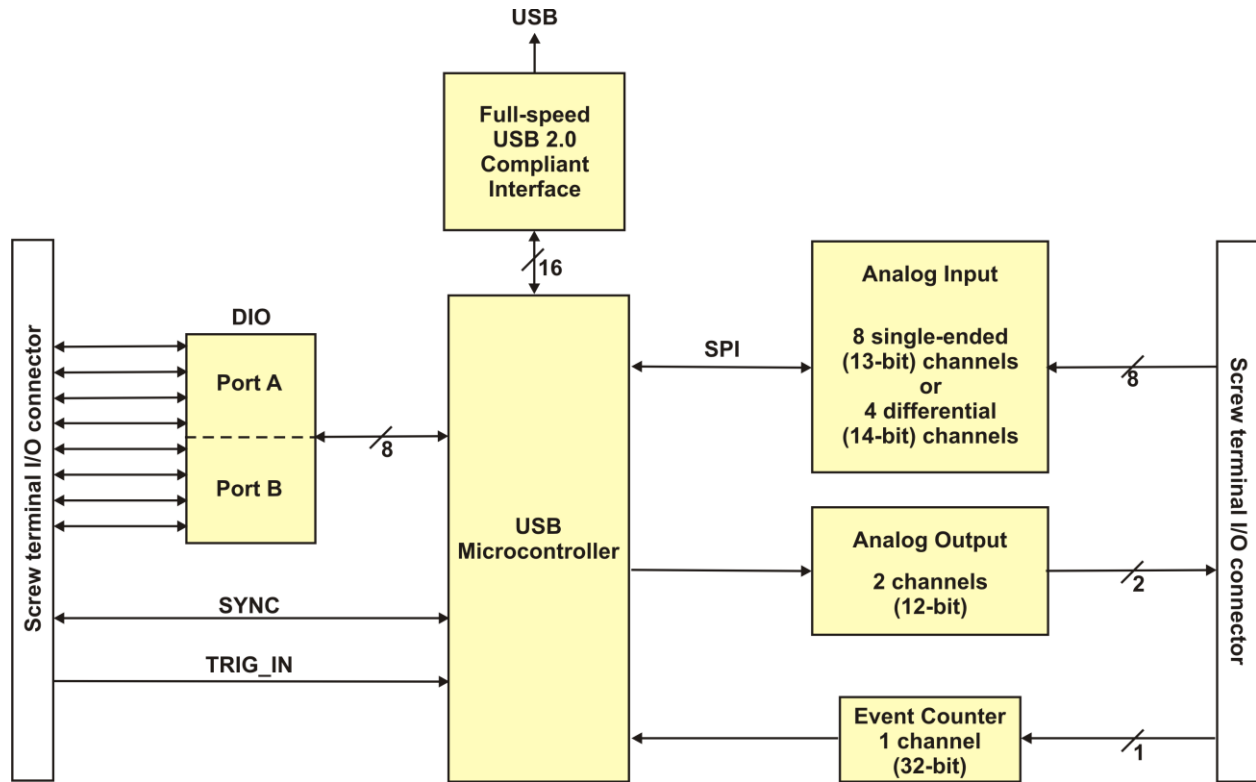

Figure 2. OM-USB-1408FS functional block diagram

Software features

For information on the features of *InstaCal* and the other software included with your OM-USB-1408FS, refer to the *OMB-DAQ-2416 Series and OM-USB Series Data Acquisition Software User's Guide* that shipped with your device.

Connecting a OM-USB-1408FS to your computer is easy

Installing a data acquisition device has never been easier.

- The OM-USB-1408FS relies upon the Microsoft Human Interface Device (HID) class drivers. The HID class drivers ship with every copy of Windows that is designed to work with USB ports. We use the Microsoft HID because it is a standard, and its performance delivers full control and maximizes data transfer rates for your OM-USB-1408FS. No third-party device driver is required.
- The OM-USB-1408FS is plug-and-play. There are no jumpers to position, DIP switches to set, or interrupts to configure.
- You can connect the OM-USB-1408FS before or after you install the software, and without powering down your computer first. When you connect an HID to your system, your computer automatically detects it and configures the necessary software. You can connect and power multiple HID peripherals to your system using a USB hub.

You can run up to two OM-USB-1408FS units on most computers.

- You can connect your system to various devices using a standard four-wire cable. The USB connector replaces the serial and parallel port connectors with one standardized plug and port combination.
- You do not need a separate power supply module. The USB automatically delivers the electrical power required by each peripheral connected to your system.
- Data can flow two ways between a computer and peripheral over USB connections.

Installing the OM-USB-1408FS

What comes with your OM-USB-1408FS shipment?

As you unpack your OM-USB-1408FS, verify that the following components are included.

Hardware

- OM-USB-1408FS (shown with cable)



- USB cable (2 meter length)



Additional documentation

In addition to this hardware user's guide, you should also receive the *OMB-DAQ-2416 Series and OM-USB Series Data Acquisition Software User's Guide*. This booklet supplies a brief description of the software you received with your OM-USB-1408FS and information regarding installation of that software. Please read this booklet completely before installing any software or hardware.

Unpacking the OM-USB-1408FS

As with any electronic device, you should take care while handling to avoid damage from static electricity. Before removing the OM-USB-1408FS from its packaging, ground yourself using a wrist strap or by simply touching the computer chassis or other grounded object to eliminate any stored static charge.

If any components are missing or damaged, notify Omega Engineering immediately by phone, fax, or e-mail.

- Phone: (203) 359-1660
- Fax: (203) 359-7700
- Email: das@omega.com

Installing the software

Refer to the *OMB-DAQ-2416 Series and OM-USB Series Data Acquisition Software User's Guide* for instructions on installing the software on the *OMB-DAQ-2416 Series and OM-USB Series Data Acquisition Software* CD. This booklet is available in PDF at <http://www.omega.com/manuals/manualpdf/M4803.pdf>.

We recommend that you download the latest Windows Update onto your computer before installing and operating the OM-USB-1408FS.

Installing the hardware

Be sure you are using the latest system software

Before you install your OM-USB-1408FS, run Windows Update to update your operating system with the latest HID and USB drivers.

To connect the OM-USB-1408FS to your system, turn your computer on, and connect the USB cable to a USB port on your computer or to an external USB hub that is connected to your computer. The USB cable provides power and communication to the OM-USB-1408FS.

When you connect the OM-USB-1408FS for the first time, a series of **Found New Hardware** popup balloons (Windows XP) or dialogs (other Windows versions) open as the OM-USB-1408FS is detected by your computer. This is normal. The last popup balloon or dialog states "Your new hardware is installed and ready to use," and the LED on the OM-USB-1408FS should flash and then remain lit. This indicates that communication is established between the OM-USB-1408FS and your computer.

You can install up to two OM-USB-1408FS units on most computers. If you need to connect more than two OM-USB-1408FS units to your computer, contact Tech Support by phone, fax, or e-mail:

- Phone: (203) 359-1660
- Fax: (203) 359-7700
- Email: das@omega.com

Caution! Do not disconnect **any** device from the USB bus while the computer is communicating with the OM-USB-1408FS, or you may lose data and/or your ability to communicate with the OM-USB-1408FS.

If the LED turns off

If the LED is illuminated but then turns off, the computer has lost communication with the OM-USB-1408FS. To restore communication, disconnect the USB cable from the computer, and then reconnect it. This should restore communication, and the LED should turn back *on*.

Allow the OM-USB-1408FS to operate for at least 30 minutes before using the device. This warm up time is required to achieve the specified rated accuracy of measurements.

Calibrating the OM-USB-1408FS

The OM-USB-1408FS is shipped fully calibrated. Calibration coefficients are stored in EEPROM. Return the device to Omega Engineering when calibration is required. The normal calibration interval is once per year.

Functional Details

Theory of operation - analog input acquisition modes

The OM-USB-1408FS can acquire analog input data in two different modes – software paced and continuous scan.

Maximum throughput is system-dependent

Maximum throughput may be lower in Windows operating systems that predate Windows XP.

Software paced mode

In software paced mode, you can acquire one analog sample at a time. You initiate the A/D conversion by calling a software command. The analog value is converted to digital and returned to the computer. You can repeat this procedure until you have the total number of samples that you want from one channel.

The maximum throughput sample rate in software paced mode is system-dependent.

Continuous scan mode

In continuous scan mode, you can acquire data from up to eight channels. The analog data is continuously acquired and converted to digital values until you stop the scan. Data is transferred in blocks of 31 samples from the OM-USB-1408FS to the memory buffer on your computer.

The maximum continuous scan rate of 48 kS/s is an aggregate rate. The total acquisition rate for all channels cannot exceed 48 kS/s. You can acquire data from one channel at 48 kS/s, two channels at 24 kS/s, and four channels at 12 kS/s. You can start a continuous scan with either a software command or with an external hardware trigger event.

External components

The OM-USB-1408FS has the following external components, as shown in Figure 3.

- USB connector
- LED
- Screw terminal banks (2)

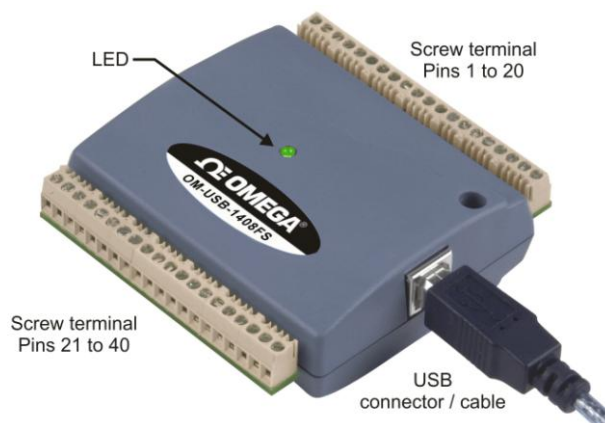

Figure 3. OM-USB-1408FS external components

USB connector

The USB connector is on the right side of the OM-USB-1408FS. This connector provides +5 V power and communication. The voltage supplied through the USB connector is system-dependent, and may be less than 5 V. No external power supply is required.

LED

The LED on the front of the housing indicates the communication status of the OM-USB-1408FS. It uses up to 5 mA of current and cannot be disabled. The table below defines the function of the OM-USB-1408FS LED.

LED Illumination

LED Illumination	Indication
Steady green	The OM-USB-1408FS is connected to a computer or external USB hub.
Blinks continuously	Data is being transferred.

Screw terminal wiring

The OM-USB-1408FS has two rows of screw terminals—one row on the top edge of the housing, and one row on the bottom edge. Each row has 20 connections. Pin numbers are identified in Figure 4.



Figure 4. OM-USB-1408FS Screw terminal pin numbers

Screw terminal – pins 1-20

The screw terminals on the top edge of the OM-USB-1408FS (pins 1 to 20) provide the following connections:

- Eight analog input connections (**CH0 IN** to **CH7 IN**)
- Two analog output connections (**D/A OUT 0** to **D/A OUT 1**)
- One external trigger source (**TRIG_IN**)
- One SYNC terminal for external clocking and multi-unit synchronization (**SYNC**)
- One voltage output source (**2.5VREF**)
- Five analog ground connections (**AGND**)
- One ground connection (**GND**)
- One external event counter connection (**CTR**)

Screw terminal – pins 21-40

The screw terminals on the bottom edge of the (pins 21 to 40) provide the following connections:

- 16 digital I/O connections (**PortA0 to Port A7**, and **Port B0 to Port B7**)
- One power connection (**PC+5 V**)
- Three ground connections (**GND**)

Main connector and pin out

Connector type	Screw terminal
Wire gauge range	16 AWG to 30 AWG

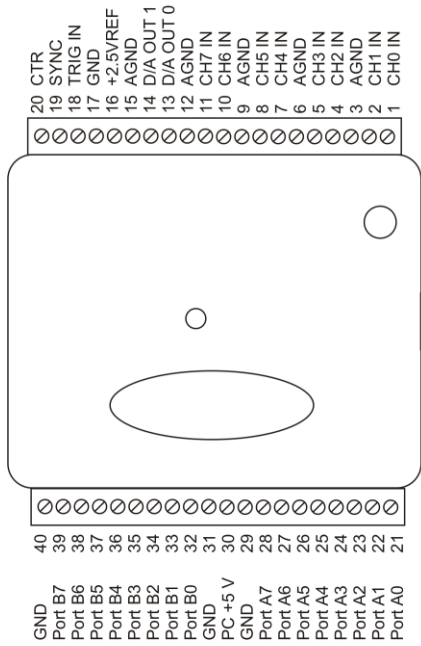

8-channel single-ended mode pin out

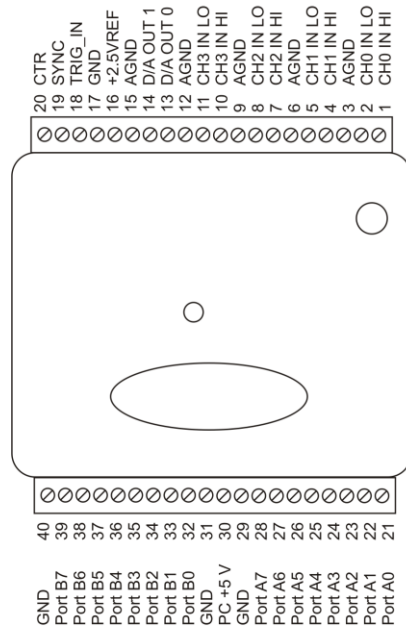

4-channel differential mode pin out

Analog input terminals (CH0 IN - CH7 IN)

You can connect up to eight analog input connections to the screw terminal containing pins 1 to 20 (**CH0 IN** through **CH7 IN**.) Refer to the pinout diagrams above for the location of these pins.

You can configure the analog input channels as eight single-ended channels or four differential channels. When configured for differential mode, each analog input has 14-bit resolution. When configured for single-ended mode, each analog input has 13-bit resolution, due to restrictions imposed by the A/D converter.

Single-ended configuration

When all of the analog input channels are configured for single-ended input mode, eight analog channels are available. The input signal is referenced to signal ground (GND), and delivered through two wires:

- The wire carrying the signal to be measured connects to CH# IN.
- The second wire connects to AGND.

The input range for single-ended mode is ± 10 V. No other ranges are supported in this mode.

Single-ended measurements using differential channels

To perform a single-ended measurement using differential channels, connect the signal to CHn IN HI input, and ground the associated CHn IN LO input.

Differential configuration

When all of the analog input channels are configured for differential input mode, four analog channels are available. In differential mode, the input signal is measured with respect to the low input.

The input signal is delivered through three wires:

- The wire carrying the signal to be measured connects to CH0 IN HI, CH1 IN HI, CH2 IN HI, or CH3 IN HI.
- The wire carrying the reference signal connects to CH0 IN LO, CH1 IN LO, CH2 IN LO, or CH3 IN LO.
- The third wire connects to GND.

A low-noise precision programmable gain amplifier (PGA) is available on differential channels to provide gains of up to 20 and a dynamic range of up to 14-bits. Differential mode input voltage ranges are ± 20 V, ± 10 V, ± 5 V, ± 4 V, ± 2.5 V, ± 2.0 V, ± 1.25 V, and ± 1.0 V.

In differential mode, the following two requirements must be met for linear operation:

- Any analog input must remain in the -10 V to $+20$ V range with respect to ground at all times.
- The maximum differential voltage on any given analog input pair must remain within the selected voltage range.

The input [*common-mode voltage + signal*] of the differential channel must be in the -10 V to $+20$ V range in order to yield a useful result. For example, you input a 4 V pp sine wave to CHHI, and apply the same sine wave 180° out of phase to CHLO. The common mode voltage is 0 V. The differential input voltage swings from 4 V - $(-4$ V) = 8 V to $(-4$ V) - 4 V = -8 V. Both inputs satisfy the -10 V to $+20$ V input range requirement, and the differential voltage is suited for the ± 10 V input range (see Figure 5).

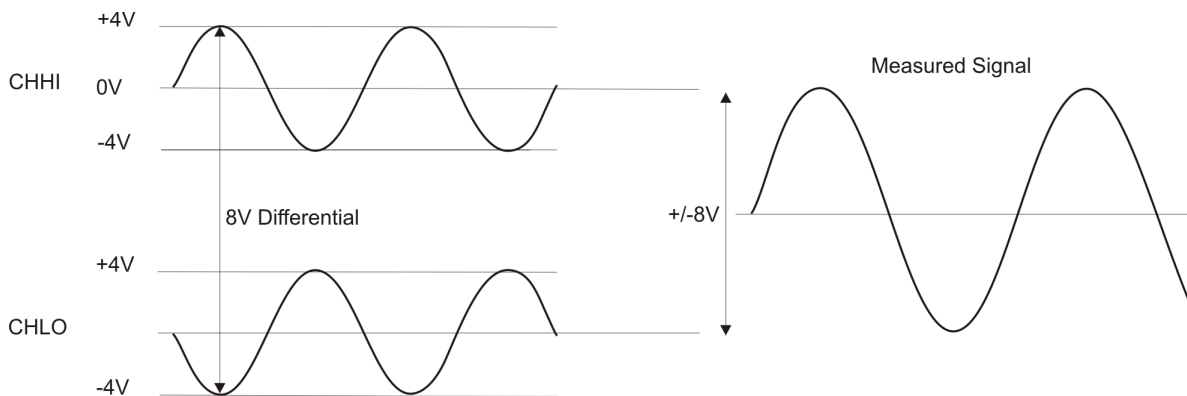

Figure 5. Differential voltage example: common mode voltage of 0 V

If you increase the common mode voltage to 11 V, the differential remains at ± 8 V. Although the [*common-mode voltage + signal*] on each input now has a range of $+7$ V to $+15$ V, both inputs still satisfy the -10 V to $+20$ V input requirement (see Figure 6).

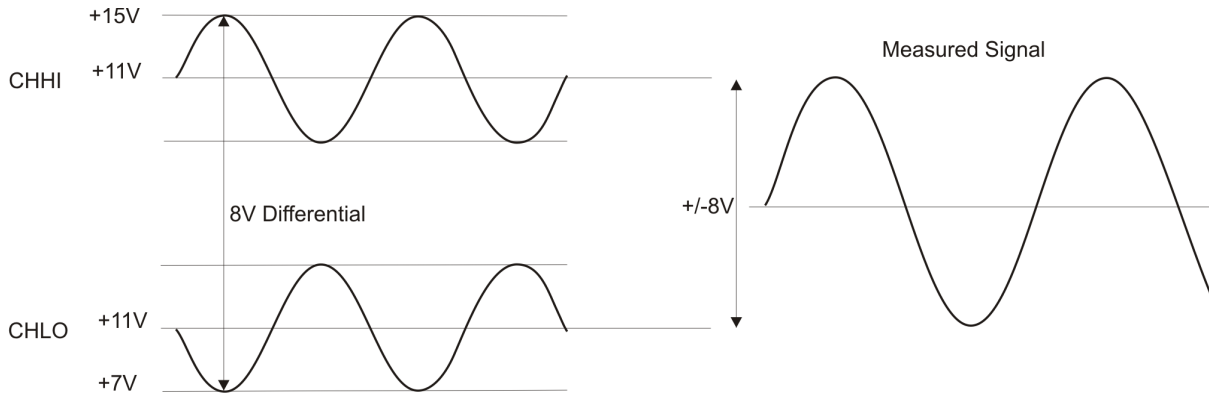

Figure 6. Differential voltage example: common mode voltage of 11 V

If you decrease the common-mode voltage to -7 V , the differential stays at $\pm 8\text{ V}$. However, the solution now violates the input range condition of -10 V to $+20\text{ V}$. The voltage on each analog input now swings from -3 V to -11 V . Voltages between -10 V and -3 V are resolved, but those below -10 V are clipped (see Figure 7).

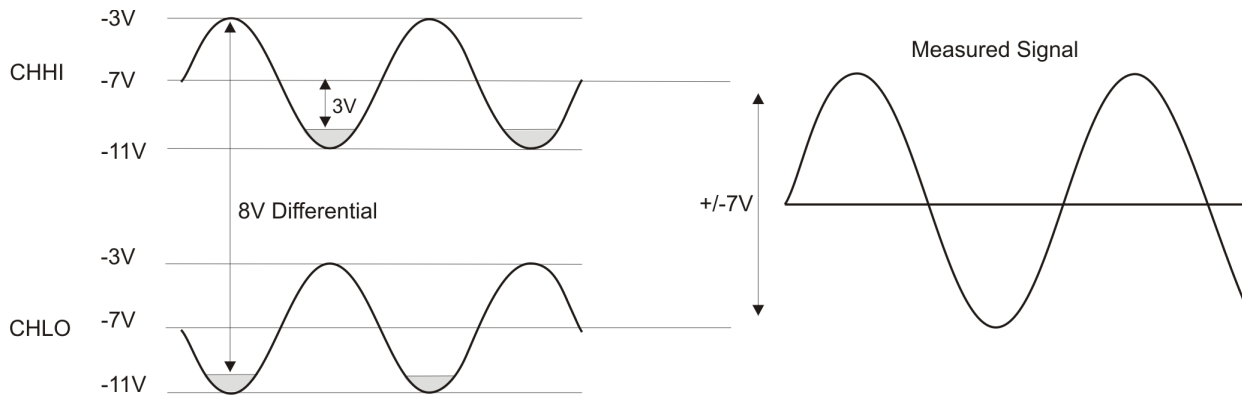

Figure 7. Differential voltage example: common mode voltage of -7 V

Since the analog inputs are restricted to a -10 V to $+20\text{ V}$ signal swing with respect to ground, all ranges *except* $\pm 20\text{ V}$ can realize a linear output for any differential signal with zero common mode voltage and full scale signal inputs. The $\pm 20\text{ V}$ range is the exception. You cannot put -20 V on CHHI and 0 V on CHLO since this violates the input range criteria. The following table shows some possible inputs and the expected results.

Sample inputs and differential results

CHHI	CHLO	Result
-20 V	0 V	In Valid
-15 V	$+5\text{ V}$	In Valid
-10 V	0 V	-10 V
-10 V	$+10\text{ V}$	-20 V
0 V	$+10\text{ V}$	-10 V
0 V	$+20\text{ V}$	-20 V
$+10\text{ V}$	-10 V	$+20\text{ V}$
$+10\text{ V}$	0 V	$+10\text{ V}$
$+15\text{ V}$	-5 V	$+20\text{ V}$
$+20\text{ V}$	0	$+20\text{ V}$

For more information on analog signal connections

For more information on single-ended and differential inputs, refer to the the *OMB-DAQ-2416 Series and OM-USB Series General Guide to Signal Connections* (available on our web site at www.omega.com/manuals/manualpdf/M4830.pdf).

Analog output terminals (D/A OUT 0 and D/A OUT 1)

You can connect up to two analog output connections to the screw terminal pins 13 and 14 (**D/A OUT 0** and **D/A OUT 1**). Refer to the pinout diagrams on page 13 for the location of these pins.

Each channel can be paced individually at rates up to 10,000 updates per second. Both channels can be paced simultaneously using the same time base at 5000 updates per channel. The 0-4.096 V output range provides a convenient 1 mV per LSB when setting the output voltage levels.

Digital I/O terminals (Port A0 to A7, and Port B0 to B7)

You can connect up to 16 digital I/O lines to the screw terminal containing pins 21 to 40 (**Port A0 to Port A7**, and **Port B0 to Port B7**.) Refer to the pinout diagrams on page 13 for the location of these pins. You can configure each digital port for either input or output.

When you configure the digital bits for input, you can use the digital I/O terminals to detect the state of any TTL level input. Refer to the schematic shown in Figure 8. If the switch is set to the +5 V input, Port A0 reads *TRUE* (1). If you move the switch to GND, Port A0 reads *FALSE*.

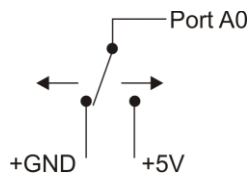

Figure 8. Schematic showing switch detection by digital channel Port A0

For more information on digital signal connections

For more information on digital signal connections and digital I/O techniques, refer to the *Guide to Signal Connections* (available on our web site at www.mccdaq.com/signals/signals.pdf).

Power terminals

The **PC +5V** connection (pin 30) draws power from the USB connector. This terminal is a 5 V output that is supplied by the host computer. Refer to the pinout diagrams on page 13 for the location of this pin.

Caution! The +5 V terminal is an output. Do not connect to an external power supply or you may damage the OM-USB-1408FS and possibly the computer.

The maximum total output current that can be drawn from all OM-USB-1408FS connections (power, analog and digital outputs) is 420 mA. This maximum applies to most personal computers and self-powered USB hubs. Bus-powered hubs and notebook computers may limit the maximum available output current to 100 mA.

Just connecting the OM-USB-1408FS to your computer draws 80 mA of current from the USB +5 V supply. Once you start running applications with the OM-USB-1408FS, each DIO bit can draw up to 2.5 mA, and each analog output can draw 15 mA. The maximum amount of +5 V current available for experimental use, over and above that required by the OM-USB-1408FS, is the difference between the *total current requirement* of the USB (based on the application), and the *allowed current draw* of the PC platform (500 mA for desktop PCs and self-powered hubs, or 100 mA for bus-powered hubs and notebook computers).

With all outputs at their maximum output current, you can calculate the total current requirement of the OM-USB-1408FS USB +5 V supply as follows:

$$(OM-USB-1408FS @ 80 \text{ mA}) + (16 \text{ DIO @ } 2.5 \text{ mA ea}) + (2 \text{ AO @ } 15 \text{ mA ea}) = 150 \text{ mA}$$

For an application running on a PC or powered hub, the maximum available excess current is $500 \text{ mA} - 150 \text{ mA} = 350 \text{ mA}$. This number is the total maximum available current at the PC +5 V screw terminals. Measurement Computing highly recommends that you figure in a safety factor of 20% below this maximum current loading for your applications. A conservative, safe user maximum in this case would be 280 mA.

Since laptop computers typically allow up to 100 mA, the OM-USB-1408FS in a fully-loaded configuration may be above that allowed by the computer. In this case, you must determine the per-pin loading in the application to ensure that the maximum loading criteria is met. The per-pin loading is calculated by simply dividing the +5 V by the load impedance of the pin in question.

External trigger terminal

The **TRIG_IN** connection (pin 18) can be configured for either rising or falling edge. Refer to the pinout diagrams on page 13 for the location of this pin.

Counter terminal

The **CTR** connection (pin 20) is input to the 32-bit external event. Refer to the pinout diagrams on page 13 for the location of this pin. The internal counter increments when the TTL levels transition from low to high. The counter can count frequencies of up to 1 MHz.

+2.5VREF terminal

The **+2.5VREF** connection (pin 16) is an output terminal that supplies 2.5 volts.

SYNC terminal

The **SYNC** connection (pin 19) is a bidirectional I/O signal. You can use it for two purposes:

- Configure as an external clock input to externally source the A/D conversions. The SYNC terminal supports TTL-level input signals of up to 48 kHz.
- Configure as an output to synchronize with a second OM-USB-1408FS and acquire data from 16 channels. For information on synchronizing multiple units, refer to page 21.

Ground terminals

The four analog ground (**AGND**) connections provide a common ground for all OM-USB-1408FS input channels. Four ground (**GND**) connections provide a common ground for the **DIO**, **TRIG_IN**, **CTR**, **SYNC** and **PC +5V** connections. Refer to the pinout diagrams on page 13 for the location of these pins.

Accuracy

The overall accuracy of any instrument is limited by the error components within the system. Quite often, resolution is incorrectly used to quantify the performance of a measurement product. While "14-bits" or "1 part in 16383" does indicate what can be resolved, it provides little insight into the quality of an absolute measurement. Accuracy specifications describe the actual results that can be realized with a measurement device.

There are three types of errors which affect the accuracy of a measurement system:

- offset
- gain
- nonlinearity

The primary error sources in the OM-USB-1408FS are offset and gain. Nonlinearity is small in the OM-USB-1408FS, and is not significant as an error source with respect to offset and gain.

Figure 9 shows an example of an ideal, error-free, OM-USB-1408FS transfer function. The typical calibrated accuracy of the OM-USB-1408FS is range-dependent, as explained in the "[Specifications](#)" chapter on page 22. We use a ± 10 V range here as an example of what you can expect when performing a measurement in this range.

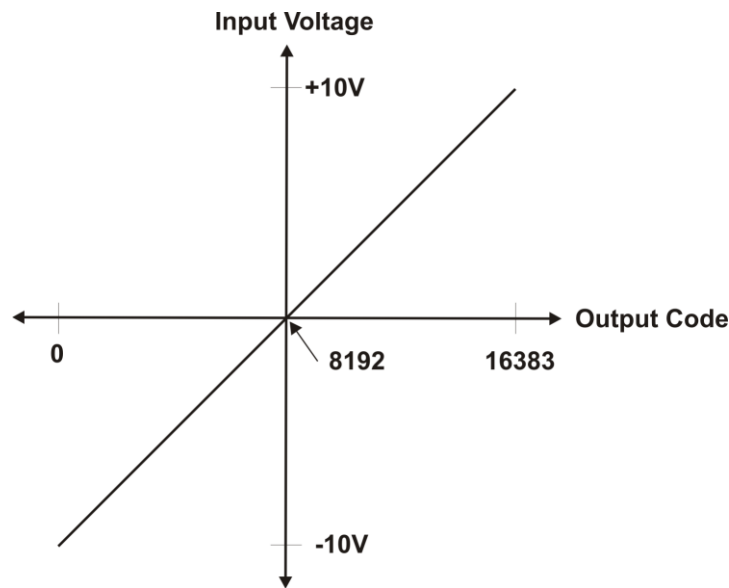

Figure 9. Ideal ADC transfer function

The offset error is measured at mid-scale. Ideally, a zero volt input should produce an output code of 8192. Any deviation from this is an offset error.

Figure 10 shows an example of a OM-USB-1408FS transfer function with a ± 2.44 mV offset error. Offset error affects all codes equally by shifting the entire transfer function up or down along the input voltage axis.

The accuracy plots in Figure 10 are drawn for clarity and are not drawn to scale.

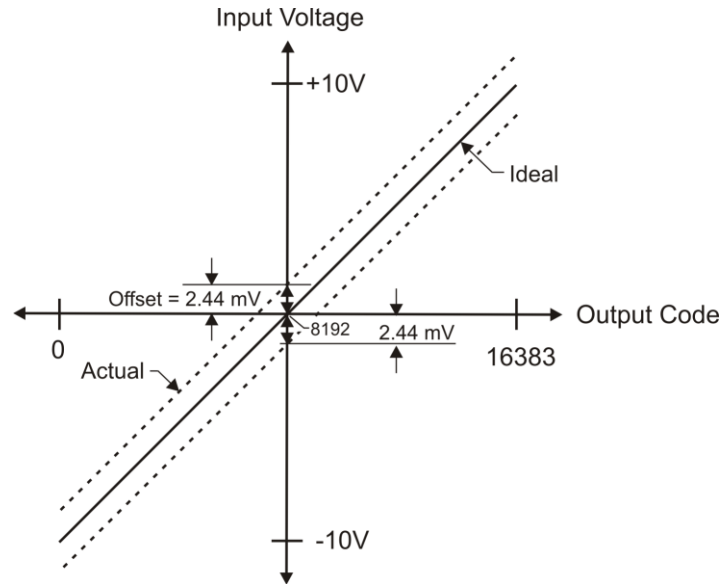

Figure 10. ADC transfer function with offset error

Gain error is a change in the slope of the transfer function from the ideal, and is typically expressed as a percentage of full-scale. Figure 11 shows the OM-USB-1408FS transfer function with gain error. Gain error is easily converted to voltage by multiplying the full-scale (**FS**) input by the error.

The accuracy plots in Figure 11 are drawn for clarity and are not drawn to scale.

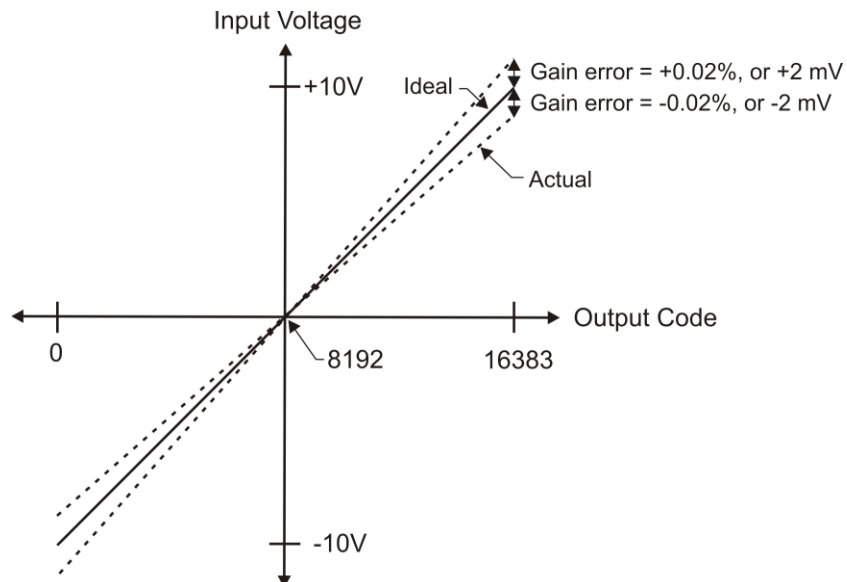

Figure 11. ADC Transfer function with gain error

Figure 11 shows an example of a OM-USB-1408FS transfer function with a calibrated gain error of $\pm 0.02\%$, or ± 2 mV. This means that at full scale, neglecting the effect of offset for the moment, the measurement would be within 2 mV of the actual value. Note that gain error is expressed as a ratio. Values near \pm FS are more affected from an absolute voltage standpoint than are values near mid-scale, which see little or no voltage error.

Combining these two error sources in Figure 12, we have a plot of the error band of the OM-USB-1408FS for the ± 10 V range. This is a graphical version of the typical accuracy specification of the product.

The accuracy plots in Figure 12 are drawn for clarity and are not drawn to scale

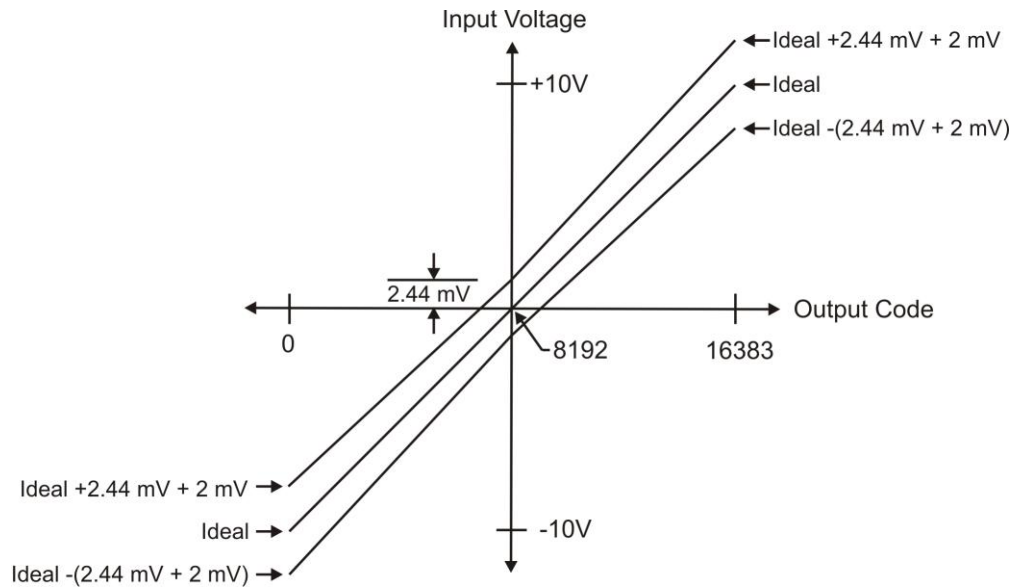

Figure 12. Error band plot

OM-USB-1408FS channel gain queue feature

The OM-USB-1408FS's channel gain queue feature allows you to set up a scan sequence with a unique per-channel gain setting and channel sequence.

The channel gain queue feature removes the restriction of using an ascending channel sequence at a fixed gain. This feature creates a channel list which is written to local memory on the OM-USB-1408FS. Each element of the channel list is made up of a channel number and range setting. An example of a four-element list is shown in the table below.

Sample channel gain queue list

Element	Channel	Range
0	CH0	BIP10V
1	CH3	BIP5V
2	CH1	BIP10V
3	CH2	BIP1V

When a scan begins with the gain queue enabled, the OM-USB-1408FS reads the first element, sets the appropriate channel number and range, and then acquires a sample. The properties of the next element are then retrieved, and another sample is acquired. This sequence continues until all elements in the gain queue have been selected. When the end of the channel list is detected, the sequence returns to the first element in the list.

This sequence repeats until the specified number of samples is gathered. You must carefully match the gain to the expected voltage range of the associated channel — otherwise, an over range condition can occur. Although this condition does not damage the OM-USB-1408FS, it does produce a useless full-scale reading. It can also introduce a long recovery time from saturation, which can affect the next measurement in the queue.

Synchronizing multiple units

You can run up to two OM-USB-1408FS units on most computers.

You can connect the SYNC pin of two OM-USB-1408FS units together in a master/slave configuration and acquire data from the analog inputs of both devices using one clock. When the SYNC pin is configured as an output, the internal A/D pacer clock is sent to the screw terminal. You can use this signal as a clock input to a second OM-USB-1408FS by connecting it to the SYNC pin of the second OM-USB-1408FS.

When used as a clock input, the SYNC pin operates in one of two modes – *Continuous* or *Gated*. The mode is software-selectable using *InstaCal*.

In the default *Continuous* mode, the OM-USB-1408FS ignores the first clock pulse in order to ensure adequate setup time. Use this mode if the unit is being paced from a continuous clock source, such as a generator.

In the *Gated* mode, it is assumed that the clock signal will be held off for an adequate amount of time for setup to occur. No clock pulses are ignored. Use this mode if you want to use the OM-USB-1408FS unit as a slave, and the source of the external clock is another USB unit.

The SYNC pin (pin 19) is set for pacer output by default. To set it for input requires a software command (see Figure 13 below).

To synchronize a master OM-USB-1408FS with a slave OM-USB-1408FS and acquire data from the analog inputs of both devices using one clock, follow the steps below.

1. Connect the SYNC pin of the master OM-USB-1408FS to the SYNC pin of the slave OM-USB-1408FS.
2. Run *InstaCal*.
3. From the **PC Board List** on the *InstaCal* main form, double-click on the OM-USB-1408FS you want to use as a slave. The **Board Configuration** dialog opens.
4. Select *Gated* from the **Ext. Clock Type** drop-down list.
5. Set the Universal Library `EXTCLOCK` option with `cbAInScan () / AInScan` for the slave OM-USB-1408FS to enable pacing from the master USB device.

This *InstaCal* option does not affect internally paced acquisition. It only affects scans that use the `EXTCLOCK` option.

An example of a master/slave configuration is shown here.

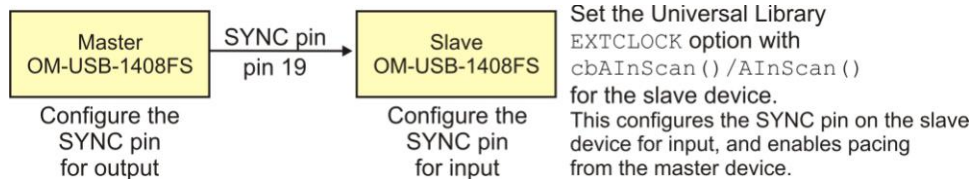

Figure 13. Configuring for synchronous data acquisition

When you are operating one OM-USB-1408FS, do not set the `EXTCLOCK` option unless you are using an external clock for A/D pacing.

Specifications

All specifications are subject to change without notice.

Typical for 25°C unless otherwise specified.

Specifications in *italic text* are guaranteed by design.

Analog input

Table 1. Analog input specifications

Parameter	Conditions	Specification
A/D converter type		Successive approximation type
Input voltage range for linear operation, single-ended mode	CHx to GND	±10 volts (V) max
Input common-mode voltage range for linear operation, differential mode	CHx to GND	-10 V min, +20 V max
<i>Absolute maximum input voltage</i>	<i>CHx to GND</i>	<i>±28 V max</i>
<i>Input impedance</i>		<i>122K Ohms</i>
Input current (Note 1)	Vin = +10 V	70 microamperes (µA) typ
	Vin = 0 V	-12 µA typ
	Vin = -10 V	-94 µA typ
Number of channels		8 single-ended / 4 differential, software selectable
Input ranges, single-ended mode		±10 V, G=2
Input ranges, differential mode		±20 V, G=1 ±10 V, G=2 ±5 V, G=4 ±4 V, G=5 ±2.5 V, G=8 ±2.0 V, G=10 ±1.25 V, G=16 ±1.0 V, G=20 Software selectable
Throughput (Note 2)	Software paced	250 samples per second (S/s) typ, PC-dependent
	Continuous scan	48 kilosamples per second (kS/s)
Channel gain queue	Up to 16 elements	Software configurable channel, range, and gain.
Resolution (Note 3)	Differential	14-bits, no missing codes
	Single-ended	13-bits
Integral linearity error		±2 least significant bit (LSB) typ
Differential linearity error		±0.5 LSB typ
Absolute accuracy long term drift (Note 4)	±20V range	±3LSB typ. (delta t = 1000 hrs)
	±4V range	±6LSB typ. (delta t = 1000 hrs)
	±1V range	±8LSB typ. (delta t = 1000 hrs)
2.5VREF accuracy (pin 16)		±36.25 mV max.
2.5VREF output current (pin 16)	Source	5 mA max.
	Sink	20 µA min, 100 µA typ
Trigger source	Software selectable	External digital: TRIG_IN

- Note 1:** Input current is a function of applied voltage on the analog input channels. For a given input voltage, V_{in} , the input leakage is approximately equal to $(8.181 * V_{in} - 12) \mu A$.
- Note 2:** Maximum throughput scanning to PC memory is machine dependent. The rates specified are for Windows XP only. Maximum rates on operating systems that predate XP may be less and must be determined through testing on your machine
- Note 3:** The ADS7871 converter only returns 13-bits (0 to 8192 codes) in single-ended mode.
- Note 4:** Extrapolating the long term drift accuracy specifications will provide the approximate long term drift of the OM-USB-1408FS intermediate input ranges.

Table 2. Accuracy, differential mode

Range	Absolute Accuracy 25°C ($\pm mV$)	Absolute Accuracy 0 to 50°C ($\pm mV$)
± 20 V	10.98	49.08
± 10 V	7.32	33.42
± 5 V	3.66	20.76
± 4 V	2.92	19.02
± 2.5 V	1.83	14.97
± 2 V	1.70	14.29
± 1.25 V	1.21	12.18
± 1 V	1.09	11.63

Table 3. Accuracy, single-ended mode

Range	Absolute Accuracy 25°C ($\pm mV$)	Absolute Accuracy 0 to 50°C ($\pm mV$)
± 10 V	10.98	49.08

Table 4. Noise performance, differential mode

Range	Typical counts	Least significant bit _{root mean square} (LSB_{rms})
± 20 V	8	1.21
± 10 V	8	1.21
± 5 V	9	1.36
± 4 V	10	1.51
± 2.5 V	12	1.81
± 2 V	14	2.12
± 1.25 V	18	2.72
± 1 V	22	3.33

Table 5. Noise performance, single-ended mode

Range	Typical Counts	LSB_{rms}
± 10 V	8.0	1.21

Analog output

Table 6. Analog output specifications

Parameter	Conditions	Specification
Resolution		12-bits, 1 in 4096
Output range		0 to 4.096 V, 1 mV per LSB.
Number of channels		2
Throughput (Note 5)	Software paced	250 S/s single channel typical, PC dependent
	Single channel, continuous scan	10 kS/s
	Dual channel, continuous scan, simultaneous update	5 kS/s
Power on and reset voltage		0V, ± 20 mV typ. (initializes to 000h code)
Output drive	Each D/A OUT	± 15 mA
Slew rate		0.8 V/microsecond (μ s) typ

Note 5: Maximum throughput scanning from PC memory is machine dependent. The rates specified are for Windows XP only. Maximum rates on operating systems that predate XP may be less and must be determined through testing on your machine.

Table 7. Analog output accuracy

Range	Accuracy (\pm LSB)
0 to 4.096 V	4.0 typ, 45.0 max

Table 8. Analog output accuracy components

Range	% of FSR (\pm)	Gain Error at FS (\pm mV)	Offset (\pm mV) (Note 6)	Accuracy at FS (\pm mV)
0 to 4.096 V	0.1 typ, 0.9 max	4.0 typ, 36.0 max	1.0 typ, 9.0 max	4.0 typ, 45.0 max

Note 6: Zero-scale offsets may result in a fixed zero-scale error producing a "dead-band" digital input code region.. In this case, changes in digital input code at values less than 0x040 may not produce a corresponding change in the output voltage. The OM-USB-1408FS offset error is tested and specified at code 0x040.

Digital input/output

Table 9. Digital I/O specifications

Digital type	CMOS
Number of I/O	16 (Port A0 through A7, Port B0 through B7)
Configuration	2 banks of 8
Pull-up/pull-down configuration	All pins pulled up to Vs via 47 K resistors (default). Positions available for pull-down to ground. Hardware selectable via zero ohm (Ω) resistors as a factory option.
Input high voltage	2.0 V min, 5.5 V absolute max
Input low voltage	0.8 V max, -0.5 V absolute min
Output high voltage (IOH = -2.5 mA)	3.8 V min
Output low voltage (IOL = 2.5 mA)	0.7 V max
Power on and reset state	Input

External trigger

Table 10. Digital trigger specifications

Parameter	Conditions	Specification
Trigger source (Note 7)	External digital	TRIG_IN
Trigger mode	Software selectable	Edge sensitive: user configurable for CMOS compatible rising or falling edge.
Trigger latency		10 μ s max
Trigger pulse width		1 μ s min
Input high voltage		4.0 V min, 5.5 V absolute max
Input low voltage		1.0 V max, -0.5 V absolute min
Input leakage current		$\pm 1.0 \mu$ A

Note 7: TRIG_IN is a Schmitt trigger input protected with a 1.5 kilohm ($k\Omega$) series resistor.

External clock input/output

Table 11. External clock I/O specifications

Parameter	Conditions	Specification
Pin name		SYNC
Pin type		Bidirectional
Software selectable direction	Output (default)	Outputs internal A/D pacer clock.
	Input	Receives A/D pacer clock from external source.
Input clock rate		48 KHz, maximum
Clock pulse width	Input mode	1 μ s min
	Output mode	5 μ s min
Input leakage current	Input mode	$\pm 1.0 \mu$ A
Input high voltage		4.0 V min, 5.5 V absolute max
Input low voltage		1.0 V max, -0.5 V absolute min
Output high voltage (Note 8)	IOH = -2.5 mA	3.3 V min
	No load	3.8 V min
Output low voltage (Note 8)	IOL = 2.5 mA	1.1 V max
	No load	0.6 V max

Note 8: SYNC is a Schmitt trigger input and is over-current protected with a 200 Ω series resistor.

Counter section

Table 12. Counter specifications

Pin name (Note 9)	CTR
Counter type	Event counter
Number of channels	1
Input type	TTL, rising edge triggered
Input source	CTR screw terminal
Resolution	32 bits
Schmidt trigger hysteresis	20 mV to 100 mV
Input leakage current	$\pm 1 \mu$ A
Maximum input frequency	1 MHz
High pulse width	500 ns min
Low pulse width	500 ns min
Input high voltage	4.0 V min, 5.5 V absolute max
Input low voltage	1.0 V max, -0.5 V absolute min

Note 9: CTR is a Schmitt trigger input protected with a 1.5K Ω series resistor.

Non-volatile memory

Table 13. Non-volatile memory specifications

EEPROM	1,024 bytes		
EEPROM Configuration	Address Range	Access	Description
	0x000-0x1FF	Read/write	512 bytes user area
	0x200-0x3FF	Read/write with unlock	512 bytes calibration data

Microcontroller

Table 14. Microcontroller specifications

Type	High performance 8-bit RISC microcontroller
Program memory	16,384 words
Data memory	2,048 bytes

Power

Table 15. Power specifications

Parameter	Conditions	Specification
Supply current (Note 10)		80 mA
+5V USB power available (Note 11)	Connected to self-powered hub Connected to externally-powered root port hub	4.5 V min, 5.25 V max
	Connected to bus-powered hub	4.1 V min, 5.25 V max
Output current (Note 12)	Connected to self-powered hub	420 mA max
	Connected to externally-powered root port hub	
	Connected to bus-powered hub	20 mA max

Note 10: This is the total current requirement for the OM-USB-1408FS which includes up to 10 mA for the status LED.

Note 11: *Self-powered hub* refers to a USB hub with an external power supply. Self-powered hubs allow a connected USB device to draw up to 500 mA.

Root port hubs reside in the PC's USB host controller. The USB port(s) on your PC are root port hubs. All externally powered root port hubs (desktop PCs) provide up to 500 mA of current for a USB device. Battery-powered root port hubs provide 100 mA or 500 mA, depending upon the manufacturer. A laptop PC that is not connected to an external power adapter is an example of a battery-powered root port hub.

Bus powered hubs receive power from a self-powered or root port hub. In this case the maximum current available from the USB +5 V is 100 mA. The minimum USB +5 V voltage level can be as low as 4.1 V.

Note 12: Output current refers to the total amount of current that can be sourced from the USB +5 V, analog outputs and digital outputs.

General

Table 16. General specifications

Parameter	Conditions	Specification
Device type		USB 2.0 full speed
Device compatibility		USB 1.1, USB 2.0

Environmental

Table 17. Environmental specifications

Operating temperature range	0 to 70 °C
Storage temperature range	-40 to 70 °C
Humidity	0 to 90% non-condensing

Mechanical

Table 18. Mechanical specifications

Dimensions	79 millimeters (mm) long x 82 mm wide x 25 mm high
USB cable length	3 meters max
User connection length	3 meters max

Main connector and pin out

Table 19. Main connector specifications

Connector type	Screw terminal
Wire gauge range	16 AWG to 30 AWG

4-channel differential mode

Pin	Signal Name	Pin	Signal Name
1	CH0 IN HI	21	Port A0
2	CH0 IN LO	22	Port A1
3	AGND	23	Port A2
4	CH1 IN HI	24	Port A3
5	CH1 IN LO	25	Port A4
6	AGND	26	Port A5
7	CH2 IN HI	27	Port A6
8	CH2 IN LO	28	Port A7
9	AGND	29	GND
10	CH3 IN HI	30	PC+5V
11	CH3 IN LO	31	GND
12	AGND	32	Port B0
13	D/A OUT 0	33	Port B1
14	D/A OUT 1	34	Port B2
15	AGND	35	Port B3
16	+2.5VREF	36	Port B4
17	GND	37	Port B5
18	TRIG IN	38	Port B6
19	SYNC	39	Port B7
20	CTR	40	GND

8-channel single-ended mode

Pin	Signal Name	Pin	Signal Name
1	CH0 IN	21	Port A0
2	CH1 IN	22	Port A1
3	AGND	23	Port A2
4	CH2 IN	24	Port A3
5	CH3 IN	25	Port A4
6	AGND	26	Port A5
7	CH4 IN	27	Port A6
8	CH5 IN	28	Port A7
9	AGND	29	GND
10	CH6 IN	30	PC+5V
11	CH7 IN	31	GND
12	AGND	32	Port B0
13	D/A OUT 0	33	Port B1
14	D/A OUT 1	34	Port B2
15	AGND	35	Port B3
16	+2.5VREF	36	Port B4
17	GND	37	Port B5
18	TRIG_IN	38	Port B6
19	SYNC	39	Port B7
20	CTR	40	GND

WARRANTY/DISCLAIMER

OMEGA ENGINEERING, INC. warrants this unit to be free of defects in materials and workmanship for a period of **13 months** from date of purchase. OMEGA's WARRANTY adds an additional one (1) month grace period to the normal **one (1) year product warranty** to cover handling and shipping time. This ensures that OMEGA's customers receive maximum coverage on each product.

If the unit malfunctions, it must be returned to the factory for evaluation. OMEGA's Customer Service Department will issue an Authorized Return (AR) number immediately upon phone or written request. Upon examination by OMEGA, if the unit is found to be defective, it will be repaired or replaced at no charge. OMEGA's WARRANTY does not apply to defects resulting from any action of the purchaser, including but not limited to mishandling, improper interfacing, operation outside of design limits, improper repair, or unauthorized modification. This WARRANTY is VOID if the unit shows evidence of having been tampered with or shows evidence of having been damaged as a result of excessive corrosion; or current, heat, moisture or vibration; improper specification; misapplication; misuse or other operating conditions outside of OMEGA's control. Components in which wear is not warranted, include but are not limited to contact points, fuses, and triacs.

OMEGA is pleased to offer suggestions on the use of its various products. However, OMEGA neither assumes responsibility for any omissions or errors nor assumes liability for any damages that result from the use of its products in accordance with information provided by OMEGA, either verbal or written. OMEGA warrants only that the parts manufactured by the company will be as specified and free of defects. OMEGA MAKES NO OTHER WARRANTIES OR REPRESENTATIONS OF ANY KIND WHATSOEVER, EXPRESSED OR IMPLIED, EXCEPT THAT OF TITLE, AND ALL IMPLIED WARRANTIES INCLUDING ANY WARRANTY OF MERCHANTABILITY AND FITNESS FOR A PARTICULAR PURPOSE ARE HEREBY DISCLAIMED. LIMITATION OF LIABILITY: The remedies of purchaser set forth herein are exclusive, and the total liability of OMEGA with respect to this order, whether based on contract, warranty, negligence, indemnification, strict liability or otherwise, shall not exceed the purchase price of the component upon which liability is based. In no event shall OMEGA be liable for consequential, incidental or special damages.

CONDITIONS: Equipment sold by OMEGA is not intended to be used, nor shall it be used: (1) as a "Basic Component" under 10 CFR 21 (NRC), used in or with any nuclear installation or activity; or (2) in medical applications or used on humans. Should any Product(s) be used in or with any nuclear installation or activity, medical application, used on humans, or misused in any way, OMEGA assumes no responsibility as set forth in our basic WARRANTY/DISCLAIMER language, and, additionally, purchaser will indemnify OMEGA and hold OMEGA harmless from any liability or damage whatsoever arising out of the use of the Product(s) in such a manner.

RETURN REQUESTS/INQUIRIES

Direct all warranty and repair requests/inquiries to the OMEGA Customer Service Department. BEFORE RETURNING ANY PRODUCT(S) TO OMEGA, PURCHASER MUST OBTAIN AN AUTHORIZED RETURN (AR) NUMBER FROM OMEGA'S CUSTOMER SERVICE DEPARTMENT (IN ORDER TO AVOID PROCESSING DELAYS). The assigned AR number should then be marked on the outside of the return package and on any correspondence.

The purchaser is responsible for shipping charges, freight, insurance and proper packaging to prevent breakage in transit.

FOR **WARRANTY** RETURNS, please have the following information available BEFORE contacting OMEGA:

1. Purchase Order number under which the product was PURCHASED,
2. Model and serial number of the product under warranty, and
3. Repair instructions and/or specific problems relative to the product.

FOR **NON-WARRANTY** REPAIRS, consult OMEGA for current repair charges. Have the following information available BEFORE contacting OMEGA:

1. Purchase Order number to cover the COST of the repair,
2. Model and serial number of the product, and
3. Repair instructions and/or specific problems relative to the product.

OMEGA's policy is to make running changes, not model changes, whenever an improvement is possible. This affords our customers the latest in technology and engineering.

OMEGA is a registered trademark of OMEGA ENGINEERING, INC.

© Copyright 2010 OMEGA ENGINEERING, INC. All rights reserved. This document may not be copied, photocopied, reproduced, translated, or reduced to any electronic medium or machine-readable form, in whole or in part, without the prior written consent of OMEGA ENGINEERING, INC.

Where Do I Find Everything I Need for Process Measurement and Control?

OMEGA...Of Course!

Shop online at omega.comSM

TEMPERATURE

- Thermocouple, RTD & Thermistor Probes, Connectors, Panels & Assemblies
- Wire: Thermocouple, RTD & Thermistor
- Calibrators & Ice Point References
- Recorders, Controllers & Process Monitors
- Infrared Pyrometers

PRESSURE, STRAIN AND FORCE

- Transducers & Strain Gages
- Load Cells & Pressure Gages
- Displacement Transducers
- Instrumentation & Accessories

FLOW/LEVEL

- Rotameters, Gas Mass Flowmeters & Flow Computers
- Air Velocity Indicators
- Turbine/Paddlewheel Systems
- Totalizers & Batch Controllers

pH/CONDUCTIVITY

- pH Electrodes, Testers & Accessories
- Benchtop/Laboratory Meters
- Controllers, Calibrators, Simulators & Pumps
- Industrial pH & Conductivity Equipment

DATA ACQUISITION

- Data Acquisition & Engineering Software
- Communications-Based Acquisition Systems
- Plug-in Cards for Apple, IBM & Compatibles
- Data Logging Systems
- Recorders, Printers & Plotters

HEATERS

- Heating Cable
- Cartridge & Strip Heaters
- Immersion & Band Heaters
- Flexible Heaters
- Laboratory Heaters

ENVIRONMENTAL MONITORING AND CONTROL

- Metering & Control Instrumentation
- Refractometers
- Pumps & Tubing
- Air, Soil & Water Monitors
- Industrial Water & Wastewater Treatment
- pH, Conductivity & Dissolved Oxygen Instruments