

**1 YEAR**  
WARRANTY

**OMEGA CARE**  
Extended Warranty Program

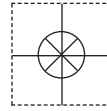

# User's Guide



*Shop online at*

**omega.com<sup>®</sup>**

Ω OMEGA<sup>®</sup>

*omega.com*

*e-mail: info@omega.com*

*For latest product manuals:  
omegamanual.info*

**ISO 9001**  
CERTIFIED  
CORPORATE QUALITY

STAMFORD, CT

**ISO 9001**  
CERTIFIED  
CORPORATE QUALITY

MANCHESTER, UK

# OM-USB-TEMP-AI 8 Channel Temperature/Voltage Measurement USB Data Acquisition Module



<b>OMEGAnet® Online Service</b> <b>omega.com</b>	<b>Internet e-mail</b> <b>info@omega.com</b>
---	---

### **Servicing North America:**

**U.S.A.:** ISO 9001 Certified Omega Engineering, Inc., One Omega Drive, P.O. Box 4047  
Stamford, CT 06907-0047 USA  
Toll Free: 1-800-826-6342 TEL: (203) 359-1660  
FAX: (203) 359-7700 e-mail: info@omega.com

**Canada:** 976 Bergar  
Laval (Quebec), H7L 5A1 Canada  
Toll-Free: 1-800-826-6342 TEL: (514) 856-6928  
FAX: (514) 856-6886 e-mail: info@omega.ca

### **For immediate technical or application assistance:**

**U.S.A. and Canada:** Sales Service: 1-800-826-6342/1-800-TC-OMEGA®  
Customer Service: 1-800-622-2378/1-800-622-BEST®  
Engineering Service: 1-800-872-9436/1-800-USA-WHEN®

**Mexico/  
Latin America:** En Español: 001 (203) 359-7803 FAX: 001 (203) 359-7807  
info@omega.com.mx e-mail: espanol@omega.com

### **Servicing Europe:**

**Benelux:** Managed by the United Kingdom Office  
Toll-Free: 0800 099 3344 TEL: +31 20 347 21 21  
FAX: +31 20 643 46 43 e-mail: sales@omegaeng.nl

**Czech Republic:** Frystatska 184  
733 01 Karviná, Czech Republic  
Toll-Free: 0800-1-66342 TEL: +420-59-6311899  
FAX: +420-59-6311114 e-mail: info@omegashop.cz

**France:** Managed by the United Kingdom Office  
Toll-Free: 0800 466 342 TEL: +33 (0) 161 37 29 00  
FAX: +33 (0) 130 57 54 27 e-mail: sales@omega.fr

**Germany/Austria:** Daimlerstrasse 26  
D-75392 Deckenpfronn, Germany  
Toll-Free: 0800 6397678 TEL: +49 (0) 7056 9398-0  
FAX: +49 (0) 7056 9398-29 e-mail: info@omega.de

**United Kingdom:** ISO 9001 Certified OMEGA Engineering Ltd.  
One Omega Drive, River Bend Technology Centre, Northbank  
Irlam, Manchester M44 5BD United Kingdom  
Toll-Free: 0800-488-488 TEL: +44 (0) 161 777-6611  
FAX: +44 (0) 161 777-6622 e-mail: sales@omega.co.uk

---

It is the policy of OMEGA Engineering, Inc. to comply with all worldwide safety and EMC/EMI regulations that apply. OMEGA is constantly pursuing certification of its products to the European New Approach Directives. OMEGA will add the CE mark to every appropriate device upon certification. The information contained in this document is believed to be correct, but OMEGA accepts no liability for any errors it contains, and reserves the right to alter specifications without notice.  
**WARNING:** These products are not designed for use in, and should not be used for, human applications.

---

# Table of Contents

## Preface

<b>About this User's Guide</b> .....	<b>5</b>
What you will learn from this user's guide .....	5
Conventions in this user's guide .....	5
Where to find more information .....	5

## Chapter 1

<b>Introducing the OM-USB-TEMP-AI</b> .....	<b>6</b>
Overview: OM-USB-TEMP-AI features.....	6
OM-USB-TEMP-AI block diagram .....	7
Software features .....	7
Connecting a OM-USB-TEMP-AI to your computer is easy .....	8

## Chapter 2

<b>Installing the OM-USB-TEMP-AI</b> .....	<b>9</b>
What comes with your OM-USB-TEMP-AI shipment?.....	9
Hardware .....	9
Additional documentation .....	9
Unpacking the OM-USB-TEMP-AI.....	9
Installing the software .....	10
Installing the OM-USB-TEMP-AI .....	10
Configuring the OM-USB-TEMP-AI.....	10
Calibrating the OM-USB-TEMP-AI .....	10

## Chapter 3

<b>Signal I/O Connections</b> .....	<b>11</b>
Screw terminal pin out .....	11
Voltage input terminals ( $\pm V_{0H}/V_{0L}$ to $\pm V_{3H}/V_{3L}$ ) .....	12
Sensor input terminals (T0H/T0L to T3H/T3L).....	12
Current excitation output terminals ( $\pm I_1$ and $\pm I_2$ ) .....	13
Four-wire, two sensor common terminals (4W01 and 4W23) .....	13
Sensor common terminals (IT01 and IT23).....	13
Digital terminals (DIO0 to DIO7).....	13
Counter terminal (CTR) .....	13
CJC sensor.....	13
Ground terminals (GND).....	13
Power terminal (+5V).....	14
Thermocouple connections .....	14
Wiring configuration .....	14
RTD and thermistor connections .....	14
Two-wire configuration.....	15
Three-wire configuration.....	16
Four-wire configuration.....	16
Semiconductor sensor measurements .....	17
Wiring configuration .....	18
Digital I/O connections .....	18

## Chapter 4

<b>Functional Details</b> .....	<b>19</b>
Thermocouple measurements .....	19
Cold junction compensation (CJC).....	19
Data linearization.....	19

Open-thermocouple detection (OTD).....	19
RTD and thermistor measurements .....	19
Data linearization.....	20
USB connector.....	20
LED.....	20
Power .....	20
<b>Chapter 5</b>	
<b>Specifications .....</b>	<b>21</b>
Analog input .....	21
Channel configurations .....	23
Compatible sensors: T0x-T3x .....	24
Accuracy .....	24
Thermocouple measurement accuracy: T0x-T3x.....	24
Semiconductor sensor measurement accuracy: T0x-T3x .....	25
RTD measurement accuracy: T0x-T3x.....	25
Thermistor measurement accuracy: T0x-T3x.....	26
Absolute Accuracy: V0x-V3x.....	27
Settling time: V0x-V3x .....	28
Analog input calibration.....	28
Throughput rate .....	28
Digital input/output .....	29
Counter.....	29
Memory.....	30
Microcontroller.....	30
USB +5V voltage .....	30
Power .....	30
USB specifications .....	30
Current excitation outputs ( $\pm I_x$ , T0x-T3x).....	31
Environmental .....	31
Mechanical.....	31
Screw terminal connector type and pin out .....	32
Screw terminal pin out.....	32

---

## About this User's Guide

### What you will learn from this user's guide

This user's guide explains how to install, configure, and use the OM-USB-TEMP-AI so that you get the most out of its USB-based temperature and voltage measurement features.

This user's guide also refers you to related documents available on our web site, and to technical support resources.

### Conventions in this user's guide

**For more information on ...**

Text presented in a box signifies additional information and helpful hints related to the subject matter you are reading.

**Caution!** Shaded caution statements present information to help you avoid injuring yourself and others, damaging your hardware, or losing your data.

<#:#> Angle brackets that enclose numbers separated by a colon signify a range of numbers, such as those assigned to registers, bit settings, etc.

**bold text** **Bold** text is used for the names of objects on the screen, such as buttons, text boxes, and check boxes. For example:  
**1.** Insert the disk or CD and click the **OK** button.

*italic text* *Italic* text is used for the names of manuals and help topic titles, and to emphasize a word or phrase. For example:  
Never touch the exposed pins or circuit connections on the board.

### Where to find more information

For additional information relevant to the operation of your hardware, refer to the *Documents* subdirectory where you installed the software, or search for your device on our website at [www.omega.com](http://www.omega.com).

---

# Introducing the OM-USB-TEMP-AI

## Overview: OM-USB-TEMP-AI features

This user's guide contains all of the information you need to connect the OM-USB-TEMP-AI to your computer and to the signals you want to measure.

The OM-USB-TEMP-AI is a USB 2.0 full-speed, temperature measurement module that is supported under popular Microsoft® Windows® operating systems. The OM-USB-TEMP-AI is fully compatible with both USB 1.1 and USB 2.0 ports.

The OM-USB-TEMP-AI provides eight analog input channels that are configured as four differential temperature inputs and four differential or single-ended voltage inputs. A 24-bit analog-to-digital (A/D) converter is provided for each pair of analog inputs. Eight independent, TTL-compatible digital I/O channels are provided to monitor TTL-level inputs, communicate with external devices, and to generate alarms. The digital I/O channels are software programmable for input or output.

The temperature input channels are configured as two channel pairs that accept temperature sensor type inputs. You can take measurements from four sensor categories. The sensor category is software programmable for each channel pair:

- Thermocouple – types J, K, R, S, T, N, E, and B
- Resistance temperature detectors (RTDs) – 2, 3, or 4-wire measurements of 100  $\Omega$  platinum RTDs
- Thermistors – 2, 3, or 4-wire measurements
- Semiconductor temperature sensors – LM36 or equivalent

You can connect a different category of sensor to each temperature channel pair, but you cannot mix sensor categories between the channels that constitute a channel pair. You can, however, mix thermocouple types within channel pairs.

Each voltage input channel is software configurable for differential or single-ended mode. The voltage input range is software programmable for  $\pm 10$  V,  $\pm 5$  V,  $\pm 2.5$  V,  $\pm 1.25$  V.

The OM-USB-TEMP-AI provides an integrated cold junction compensation (CJC) sensor for thermocouple measurements, and built-in current excitation sources for resistive sensor measurements.

An open thermocouple detection feature lets you detect a broken thermocouple. An on-board microprocessor automatically linearizes the measurement data according to the sensor category.

The OM-USB-TEMP-AI is a standalone plug-and-play module which draws power from the USB cable. No external power supply is required. All configurable options are software programmable.

The OM-USB-TEMP-AI is fully software calibrated.

## OM-USB-TEMP-AI block diagram

OM-USB-TEMP-AI functions are illustrated in the block diagram shown here.

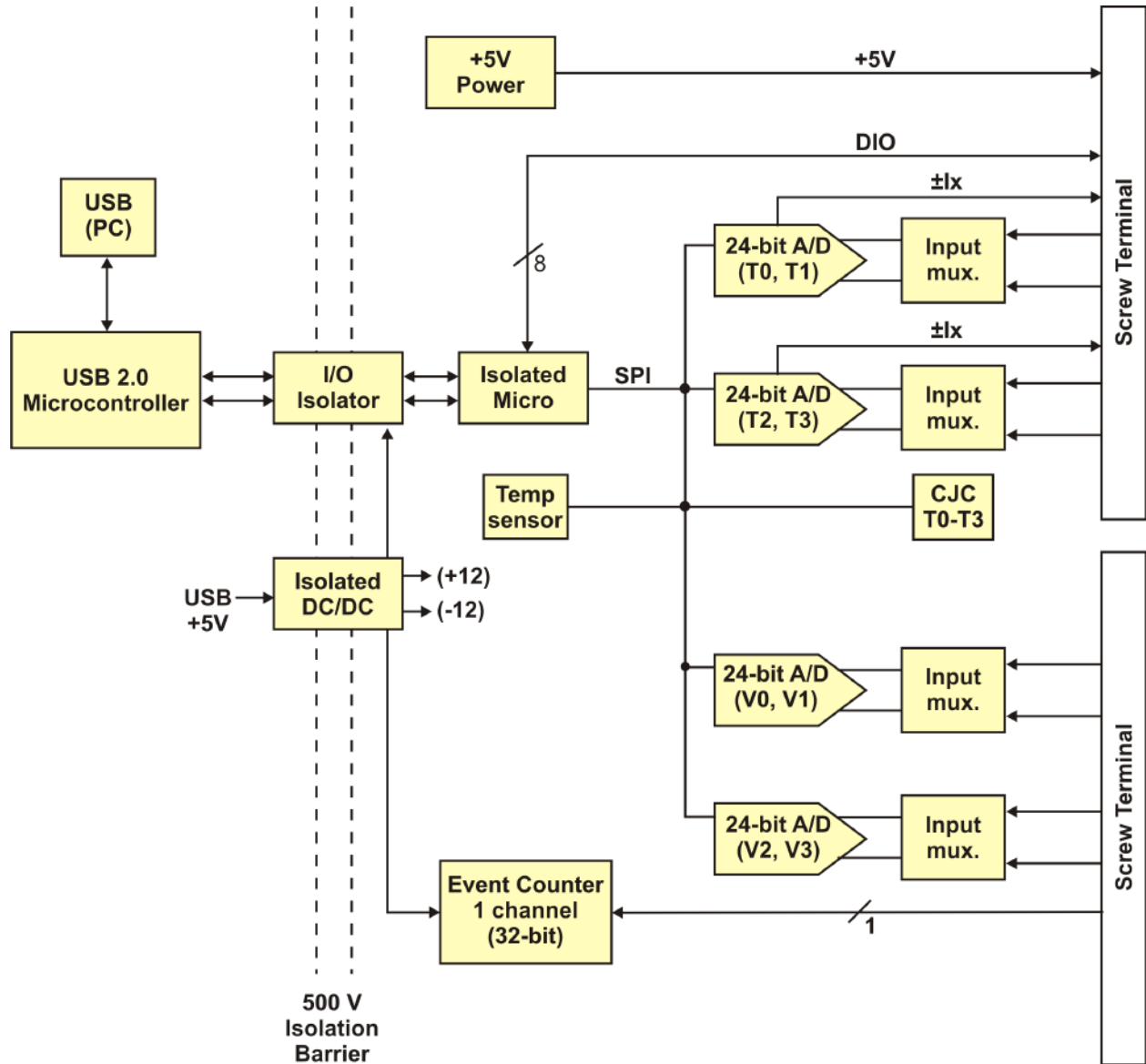

Figure 1. OM-USB-TEMP-AI functional block diagram

## Software features

For information on the features of *InstaCal* and the other software included with your OM-USB-TC, refer to the *OMB-DAQ-2416 Series and OM-USB Series Data Acquisition Software User's Guide* that shipped with your device.

## **Connecting a OM-USB-TEMP-AI to your computer is easy**

Installing a data acquisition device has never been easier:

- The OM-USB-TEMP-AI relies upon the Microsoft Human Interface Device (HID) class drivers. The HID class drivers ship with every copy of Windows that is designed to work with USB ports. We use the Microsoft HID because it is a standard, and its performance delivers full control and maximizes data transfer rates for your OM-USB-TEMP-AI. No third-party device driver is required.
- The OM-USB-TEMP-AI is plug-and-play. There are no jumpers to position, DIP switches to set, or interrupts to configure.
- You can connect the OM-USB-TEMP-AI before or after you install the software, and without powering down your computer first. When you connect an HID to your system, your computer automatically detects it and configures the necessary software. You can connect and power multiple HID peripherals to your system using a USB hub.
- You can connect your system to various devices using a standard USB cable. The USB connector replaces the serial and parallel port connectors with one standardized plug and port combination.
- You do not need a separate power supply module. The USB automatically delivers the electrical power required by each peripheral connected to your system.
- Data can flow two ways between a computer and peripheral over USB connections.



---

## Installing the OM-USB-TEMP-AI

### What comes with your OM-USB-TEMP-AI shipment?

The following items are shipped with the OM-USB-TEMP-AI.

#### Hardware

- OM-USB-TEMP-AI



- USB cable (2 meter length)



#### Additional documentation

In addition to this hardware user's guide, you should also receive the *OMB-DAQ-2416 Series and OM-USB Series Data Acquisition Software User's Guide*. This booklet supplies a brief description of the software you received with your OM-USB-TEMP-AI and information regarding installation of that software. Please read this booklet completely before installing any software or hardware.

### Unpacking the OM-USB-TEMP-AI

As with any electronic device, you should take care while handling to avoid damage from static electricity. Before removing the OM-USB-TEMP-AI from its packaging, ground yourself using a wrist strap or by simply touching the computer chassis or other grounded object to eliminate any stored static charge.

If any components are missing or damaged, notify Omega Engineering immediately by phone, fax, or e-mail.

- Phone: (203) 359-1660
- Fax: (203) 359-7700
- Email: [das@omega.com](mailto:das@omega.com)

## Installing the software

Refer to the *OMB-DAQ-2416 Series and OM-USB Series Data Acquisition Software User's Guide* for instructions on installing the software on the *OMB-DAQ-2416 Series and OM-USB Series Data Acquisition Software* CD. This booklet is available in PDF at <http://omega.com/manuals>.

We recommend that you download the latest Windows Update onto your computer before installing and operating the OM-USB-TEMP-AI.

## Installing the OM-USB-TEMP-AI

To connect the OM-USB-TEMP-AI to your system, turn your computer on, and connect the USB cable to a USB port on your computer or to an external USB hub that is connected to your computer. The USB cable provides power and communication to the OM-USB-TEMP-AI.

When you connect the OM-USB-TEMP-AI for the first time, a notification message opens as the OM-USB-TEMP-AI is detected. When the message closes, the installation is complete. The **USB LED** should flash and then remain lit. This indicates that communication is established between the OM-USB-TEMP-AI and your computer.

### If the LED turns off

If the LED is lit but then turns off, the computer has lost communication with the OM-USB-TEMP-AI. To restore communication, disconnect the USB cable from the computer, and then reconnect it. This should restore communication, and the LED should turn back *on*.

## Configuring the OM-USB-TEMP-AI

All hardware configuration options on the OM-USB-TEMP-AI are programmable with software. Use *InstaCal* to set the sensor type for each temperature channel and the range and input configuration of each voltage channel. Any channel you don't intend to use should be left disabled.

The configurable options dynamically update according to the selected sensor category. Configuration options are stored on the OM-USB-TEMP-AI's isolated microcontroller in EEPROM, which is non-volatile memory on the OM-USB-TEMP-AI module. Configuration options are loaded on power up.

### Default configuration

The factory default configuration is *Disabled*. The Disabled mode disconnects the analog inputs from the terminal blocks and internally grounds all of the A/D inputs. This mode also disables each of the current excitation sources.

### Warm up

Allow the OM-USB-TEMP-AI to warm up for 30 minutes before taking measurements. This warm up time minimizes thermal drift and achieves the specified rated accuracy of measurements.

For analog, RTD or thermistor measurements, this warm-up time is also required to stabilize the internal current reference.

## Calibrating the OM-USB-TEMP-AI

The OM-USB-TEMP-AI is fully calibrated via software. *InstaCal* prompts you to run its calibration utility when you change from one sensor category to another.

Allow the OM-USB-TEMP-AI to operate for at least 30 minutes before calibrating. This warm up time minimizes thermal drift and achieves the specified rated accuracy of measurements.

# Signal I/O Connections

## Screw terminal pin out

The OM-USB-TEMP-AI has four rows of screw terminals — two rows on the top edge of the housing, and two rows on the bottom edge. Each row has 26 connections. Between screw terminals 10 and 11 is the integrated CJC sensor used for thermocouple measurements. Signals are identified in Figure 2.

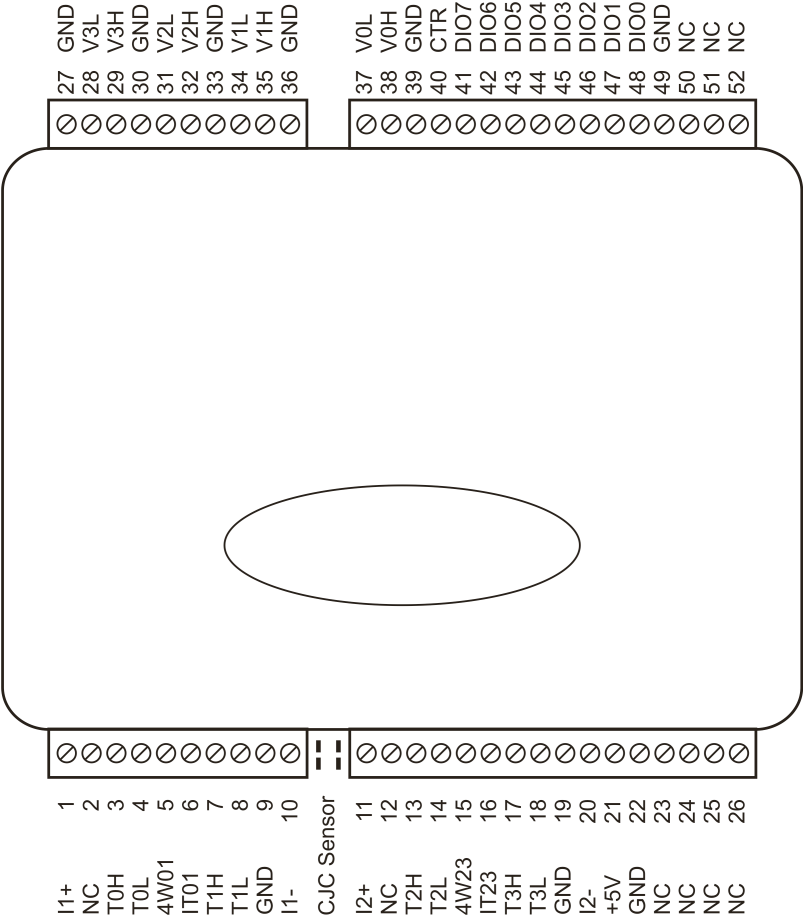

Figure 2. OM-USB-TEMP-AI screw terminal pin numbers

OM-USB-TEMP-AI screw terminal descriptions

Pin	Signal Name	Pin Description	Pin	Signal Name	Pin Description
1	I1+	T0/T1 current excitation source	27	GND	
2	NC		28	V3L	V3 voltage input (-)
3	T0H	T0 sensor input (+)	29	V3H	V3 voltage input (+)
4	T0L	T0 sensor input (-)	30	GND	
5	4W01	T0/T1 4-wire, 2 sensor common	31	V2L	V2 voltage input (-)
6	IT01	T0/T1 2-sensor common	32	V2H	V2 voltage input (+)
7	T1H	T1 sensor input (+)	33	GND	
8	T1L	T1 sensor input (-)	34	V1L	V1 voltage input (-)
9	GND		35	V1H	V1 voltage input (+)
10	I1-	T0/T1 current excitation return	36	GND	
	CJC sensor				
11	I2+	T2/T3 current excitation source	37	V0L	V0 voltage input (-)
12	NC		38	V0H	V0 voltage input (+)
13	T2H	T2 sensor input (+)	39	GND	
14	T2L	T2 sensor input (-)	40	CTR	Counter Input
15	4W23	T2/T3 4-wire, 2 sensor common	41	DIO7	Digital Input/Output
16	IT23	T2/T3 2 sensor common	42	DIO6	Digital Input/Output
17	T3H	T3 sensor input (+)	43	DIO5	Digital Input/Output
18	T3L	T3 sensor input (-)	44	DIO4	Digital Input/Output
19	GND		45	DIO3	Digital Input/Output
20	I2-	T2/T3 current excitation return	46	DIO2	Digital Input/Output
21	+5V	+5V output	47	DIO1	Digital Input/Output
22	GND		48	DIO0	Digital Input/Output
23	NC		49	GND	
24	NC		50	NC	
25	NC		51	NC	
26	NC		52	NC	

Use 16 AWG to 30 AWG wire for your signal connections.

#### Tighten screw terminal connections

When making connections to the screw terminals, be sure to tighten the screw until tight. Simply touching the top of the screw terminal is not sufficient to make a proper connection.

#### Voltage input terminals ( $\pm V0H/V0L$ to $\pm V3H/V3L$ )

You can connect up to four voltage inputs to the voltage channels (V0H/V0L to V3H/V3L). The input range is software programmable for  $\pm 10$  V,  $\pm 5$  V,  $\pm 2.5$  V, or  $\pm 1.25$  V. Each voltage channel is software configurable for differential or single-ended mode.

When connecting differential inputs to floating input sources, you must provide a DC return path from each differential input to ground. One way to do this is to connect a resistor from one side of each of the differential inputs to GND. A value of approximately 100 k $\Omega$  can be used for most applications.

**Caution!** All ground pins on the OM-USB-TEMP-AI (pins 9, 19, 22, 27, 30, 33, 36, 39, 49) are common and are isolated from earth ground. If a connection is made to earth ground when using digital I/O and conductive thermocouples, the thermocouples are no longer isolated. In this case, thermocouples must not be connected to any conductive surfaces that may be referenced to earth ground.

#### Sensor input terminals (T0H/T0L to T3H/T3L)

The OM-USB-TEMP-AI supports the following temperature sensor types:

- Thermocouple – types J, K, R, S, T, N, E, and B
- Resistance temperature detectors (RTDs) – 2, 3, or 4-wire measurement modes of 100  $\Omega$  platinum RTDs.
- Thermistors – 2, 3, or 4-wire measurement modes.
- Semiconductor temperature sensors – LM36 or equivalent

**Sensor selection**

The type of sensor you select will depend on your application needs. Review the temperature ranges and accuracies of each sensor type to determine which is best suited for your application.

You can connect up to four temperature sensors to the differential sensor inputs (T0H/T0L to T3H/T3L). Supported sensor categories include thermocouples, RTDs, thermistors, or semiconductor sensors.

Do not mix sensor categories within channel pairs. You can mix thermocouple types (J, K, R, S, T, N, E, and B) within channel pairs, however.

**Do not connect two different sensor categories to the same channel pair**

The OM-USB-TEMP-AI provides a 24 bit A/D converter for each channel pair. Each channel pair can monitor one sensor category. To monitor a sensor from a different category, connect the sensor to a different pair of sensor input terminals.

**Current excitation output terminals ( $\pm I1$  and  $\pm I2$ )**

The OM-USB-TEMP-AI has two dedicated pairs of current excitation output terminals ( $\pm I1$  and  $\pm I2$ ). These terminals have a built-in precision current source to provide excitation for the resistive sensors used for RTD and thermistor measurements. Each current excitation terminal is dedicated to one pair of sensor input channels:

- I1+ is the current excitation source, and I1- is the current excitation return for channel 0 and channel 1
- I2+ is the current excitation source, and I2- is the current excitation return for channel 2 and channel 3

**Four-wire, two sensor common terminals (4W01 and 4W23)**

The 4W01 and 4W23 terminals are used as the common connection for four-wire configurations with two RTD or thermistor sensors.

**Sensor common terminals (IT01 and IT23)**

The IT01 and IT23 terminals are used as the common connection for two-wire configurations with two RTD or thermistor sensors.

**Digital terminals (DIO0 to DIO7)**

You can connect up to eight digital I/O lines to the screw terminals labeled **DIO0** to **DIO7**. Each terminal is software configurable for input or output.

**Counter terminal (CTR)**

The **CTR** terminal (pin 40) is the input to the 32-bit event counter. The internal counter increments when the TTL level transitions from low to high. The counter can count events at frequencies of up to 1 MHz.

**Caution!** All ground pins on the OM-USB-TEMP-AI (pins 9, 19, 22, 27, 30, 33, 36, 39, 49) are common and are isolated from earth ground. If a connection is made to earth ground when using digital I/O and conductive thermocouples, the thermocouples are no longer isolated. In this case, thermocouples must not be connected to any conductive surfaces that may be referenced to earth ground.

**CJC sensor**

The OM-USB-TEMP-AI has one built-in high-resolution temperature sensor. The CJC sensor measures the ambient temperature at the terminal block so that the cold junction voltage can be calculated.

**Ground terminals (GND)**

The nine ground terminals (**GND**) provide a common ground for the input channels and DIO bits and are isolated (500 VDC) from the USB GND.

## Power terminal (+5V)

The **+5V** output terminal is isolated (500 VDC) from the USB +5V.

## Thermocouple connections

A thermocouple consists of two dissimilar metals that are joined together at one end. When the junction of the metals is heated or cooled, a voltage is produced that correlates to temperature.

The OM-USB-TEMP-AI makes fully differential thermocouple measurements without requiring ground-referencing resistors. A 32-bit floating point value in either a voltage or temperature format is returned by software. An open thermocouple detection (OTD) feature is available for each thermocouple input. This feature automatically detects an open or broken thermocouple.

Use *InstaCal* to select the thermocouple type (J, K, R, S, T, N, E, and B) on one or more sensor input channels to connect the thermocouple.

## Wiring configuration

Connect the thermocouple to the OM-USB-TEMP-AI using a differential configuration, as shown in Figure 3.

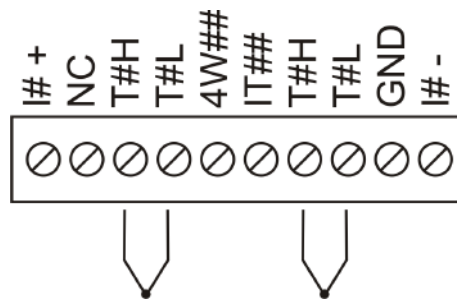

Figure 3. Typical thermocouple connection

The OM-USB-TEMP-AI **GND** pins are isolated from earth ground. You can connect thermocouple sensors to voltages referenced to earth ground as long as the isolation between the GND pins and earth ground is maintained.

When thermocouples are attached to conductive surfaces, the voltage differential between multiple thermocouples must remain within  $\pm 1.4$  V. For best results, we recommend the use of insulated or ungrounded thermocouples when possible.

### Maximum input voltage between analog input and ground

The absolute maximum input voltage between an analog input and the isolated GND pins is  $\pm 25$  VDC when the OM-USB-TEMP-AI is powered on, and  $\pm 40$  VDC when the OM-USB-TEMP-AI is powered off.

If you need to increase the length of your thermocouple, use the same type of thermocouple wires to minimize the error introduced by thermal EMFs.

## RTD and thermistor connections

A resistance temperature detector (RTD) measures temperature by correlating the resistance of the RTD element with temperature. A thermistor is a thermally-sensitive resistor that is similar to an RTD in that its resistance changes with temperature — thermistors show a large change in resistance that is proportional to a small change in temperature. The main difference between RTD and thermistor measurements is the method used to linearize the sensor data.

RTDs and thermistors are resistive devices that require an excitation current to produce a voltage drop that can be measured differentially across the sensor. The OM-USB-TEMP-AI features two built-in current excitation sources ( $\pm I1$  and  $\pm I2$ ) for measuring resistive type sensors. Each current excitation terminal is dedicated to one channel pair.

The OM-USB-TEMP-AI makes two, three, and four-wire measurements of RTDs (100  $\Omega$  platinum type) and thermistors.

Use *InstaCal* to select the sensor type and the wiring configuration. Once the resistance value is calculated, the value is linearized in order to convert it to a temperature value. A 32-bit floating point value in either temperature or resistance is returned by software.

#### RTD maximum resistance

Resistance values greater than 660  $\Omega$  cannot be measured by the OM-USB-TEMP-AI in the RTD mode. The 660  $\Omega$  resistance limit includes the total resistance across the current excitation ( $\pm I_x$ ) pins, which is the sum of the RTD resistance and the lead resistances.

#### Thermistor maximum resistance

Resistance values greater than 180 k $\Omega$  cannot be measured by the OM-USB-TEMP-AI in the thermistor mode. The 180 k $\Omega$  resistance limit includes the total resistance across the current excitation ( $\pm I_x$ ) pins, which is the sum of the thermistor resistance and the lead resistance.

### Two-wire configuration

The easiest way to connect an RTD sensor or thermistor to the OM-USB-TEMP-AI is with a two-wire configuration, since it requires the fewest connections to the sensor. With this method, the two wires that provide the RTD sensor with its excitation current also measure the voltage across the sensor.

Since RTDs exhibit a low nominal resistance, measurement accuracy can be affected due to the lead wire resistance. For example, connecting lead wires that have a resistance of 1  $\Omega$  (0.5  $\Omega$  each lead) to a 100  $\Omega$  platinum RTD will result in a 1% measurement error.

With a two-wire configuration, you can connect either one sensor per channel pair, or two sensors per channel pair.

#### Two-wire, single-sensor

A two-wire single-sensor measurement configuration is shown in Figure 4.

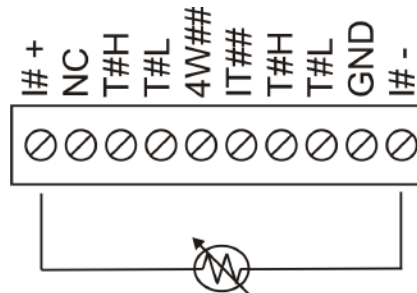

Figure 4. Two-wire, single RTD or thermistor sensor measurement configuration

When you select a two-wire single sensor configuration with *InstaCal*, connections to T#H and T#L are made internally.

#### Two-wire, two sensor

A two-wire, two-sensor measurement configuration is shown in Figure 5.

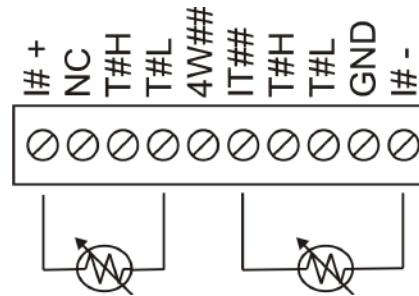

Figure 5. Two-wire, two RTD or thermistor sensors measurement configuration

When you select a two-wire, two sensor configuration with *InstaCal*, connections to T#H (first sensor) and T#H/T#L (second sensor) are made internally.

When configured for two-wire mode, both sensors must be connected to obtain proper measurements.

### Three-wire configuration

A three-wire configuration compensates for lead-wire resistance by using a single voltage sense connection. With a three-wire configuration, you can connect only one sensor per channel pair. A three-wire measurement configuration is shown in Figure 6.

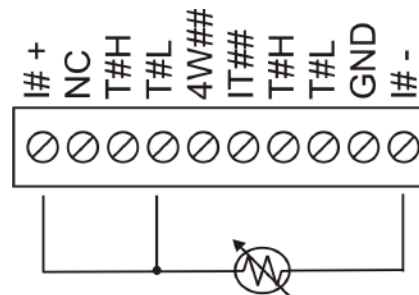

Figure 6. Three-wire RTD or thermistor sensor measurement configuration

When you select a three-wire sensor configuration with *InstaCal*, the OM-USB-TEMP-AI measures the lead resistance on the first channel (T#H/T#L) and measures the sensor itself using the second channel (T#H/T#L). This configuration compensates for any lead-wire resistance and temperature change in lead-wire resistance. Connections to T#H for the first channel and T#H/T#L of the second channel are made internally.

#### Three-wire compensation

For accurate three wire compensation, the individual lead resistances connected to the  $\pm I\#$  pins must be of equal resistance value.

### Four-wire configuration

With a four-wire configuration, connect two sets of sense/excitation wires at each end of the RTD or thermistor sensor. This configuration completely compensates for any lead-wire resistance and temperature change in lead-wire resistance.

Connect your sensor with a four-wire configuration when your application requires very high accuracy measurements. Examples of a four-wire single-sensor measurement configuration are shown in Figure 7 and Figure 8.

You can configure the OM-USB-TEMP-AI with either a single sensor per channel or two sensors per channel pair.

#### Four-wire, single-sensor

A four-wire, single-sensor connected to the first channel of a channel pair is shown in Figure 7.



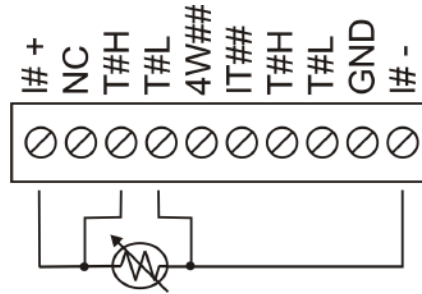

Figure 7. Four-wire, single RTD or thermistor sensor measurement configuration

A four-wire, single-sensor connected to the second channel of a channel pair is shown in Figure 8.

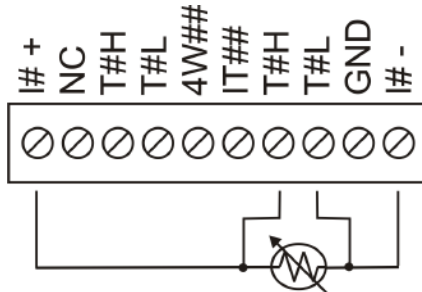

Figure 8. Four-wire, single RTD or thermistor sensor measurement configuration

A four-wire, two-sensor measurement configuration is shown in Figure 9.

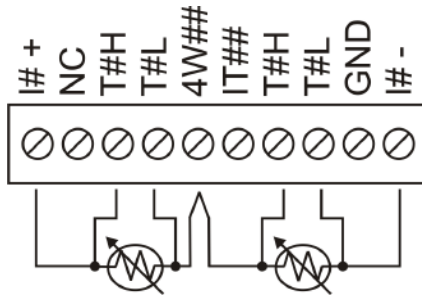

Figure 9. Four-wire, two RTD or thermistor sensors measurement configuration

When configured for four-wire, two sensor mode, both sensors must be connected to obtain proper measurements.

## Semiconductor sensor measurements

Semiconductor sensors are suitable over a range of approximately -40 °C to 125 °C, where an accuracy of  $\pm 2$  °C is adequate. The temperature measurement range of a semiconductor sensor is small when compared to thermocouples and RTDs. However, semiconductor sensors can be accurate, inexpensive and easy to interface with other electronics for display and control.

The OM-USB-TEMP-AI makes high-resolution measurements of semiconductor sensors, such as the LM36 or equivalent, and returns a 32-bit floating point value in either a voltage or temperature format.

Use *InstaCal* to select the sensor type (TMP36 or equivalent) and the sensor input channel to connect the sensor.

### Wiring configuration

You can connect a TMP36 (or equivalent) semiconductor sensor using a single-ended configuration, as shown in Figure 10. The OM-USB-TEMP-AI also provides +5V and GND pins for powering the sensor.

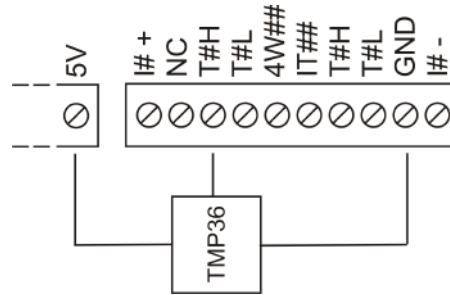

Figure 10. Semiconductor sensor measurement configuration

The software outputs the measurement data as a 32-bit floating point value in either voltage or temperature.

### Digital I/O connections

You can connect up to eight digital I/O lines to the screw terminals labeled **DIO0** to **DIO7**. You can configure each digital bit for either input or output. All digital I/O lines are pulled up to +5V with a 47 k<sub>Ω</sub> resistor (default). You can request the factory to configure the resistor for pull-down to ground if desired.

When you configure the digital bits for input, you can use the OM-USB-TEMP-AI digital I/O terminals to detect the state of a TTL-compatible device. Refer to the schematic shown in Figure 11. If you set the switch to the +5V input, DIO0 reads *TRUE* (1). If you move the switch to GND, DIO0 reads *FALSE* (0).

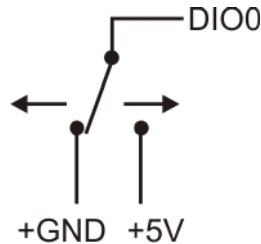

Figure 11. Schematic showing switch detection by digital channel DIO0

**Caution!** All ground pins on the OM-USB-TEMP-AI (pins 9, 19, 22, 27, 30, 33, 36, 39, 49) are common and are isolated from earth ground. If a connection is made to earth ground when using digital I/O and conductive thermocouples, the thermocouples are no longer isolated. In this case, thermocouples must not be connected to any conductive surfaces that may be referenced to earth ground.

For general information regarding digital signal connections and digital I/O techniques, refer to the *General Guide to Signal Connections* (available on our web site at [www.omega.com/manuals/manualpdf/M4830.pdf](http://www.omega.com/manuals/manualpdf/M4830.pdf)).

---

## Functional Details

### Thermocouple measurements

A thermocouple consists of two dissimilar metals that are joined together at one end. When the junction of the metals is heated or cooled, a voltage is produced that correlates to temperature.

The OM-USB-TEMP-AI hardware level-shifts the thermocouple's output voltage into the A/D's common mode input range by applying +2.5 V to the thermocouple's low side at the C#L input. Always connect thermocouple sensors to the OM-USB-TEMP-AI in a floating fashion. Do not attempt to connect the thermocouple low side C#L to GND or to a ground referencing resistor.

#### Cold junction compensation (CJC)

When you connect the thermocouple sensor leads to the sensor input channel, the dissimilar metals at the OM-USB-TEMP-AI terminal blocks produce two additional thermocouple junctions. This junction creates a small voltage error term which must be removed from the overall sensor measurement using a cold junction compensation technique. The measured voltage includes both the thermocouple voltage and the cold junction voltage. To compensate for the additional cold junction voltage, the OM-USB-TEMP-AI subtracts the *cold junction* voltage from the thermocouple voltage.

The OM-USB-TEMP-AI has one high-resolution temperature sensor integrated into the design. The CJC sensor measures the average temperature at the terminal block so that the cold junction voltage can be calculated. A software algorithm automatically corrects for the additional thermocouples created at the terminal blocks by subtracting the calculated cold junction voltage from the analog input's thermocouple voltage measurement.

#### Increasing the thermocouple length

If you need to increase the length of your thermocouple, use the same type of thermocouple wires to minimize the error introduced by thermal EMFs.

#### Data linearization

After the CJC correction is performed on the measurement data, an on-board microcontroller automatically linearizes the thermocouple measurement data using National Institute of Standards and Technology (NIST) linearization coefficients for the selected thermocouple type. The measurement data is then output as a 32-bit floating point value in the configured format (voltage or temperature).

#### Open-thermocouple detection (OTD)

The OM-USB-TEMP-AI is equipped with open-thermocouple detection for each analog input channel. With OTD, any open-circuit or short-circuit condition at the thermocouple sensor is detected by the software. An open channel is detected by driving the input voltage to a negative value outside the range of any thermocouple output. The software recognizes this as an invalid reading and flags the appropriate channel. The software continues to sample all channels when OTD is detected.

### RTD and thermistor measurements

RTDs and thermistors are resistive devices that require an excitation current to produce a voltage drop that can be measured differentially across the sensor. The OM-USB-TEMP-AI measures the sensor resistance by forcing a known excitation current through the sensor and then measuring (differentially) the voltage across the sensor to determine its resistance.

After the voltage measurement is made, the resistance of the RTD is calculated using Ohms law – the sensor resistance is calculated by dividing the measured voltage by the current excitation level ( $\pm I_x$ ) source. The value of the  $\pm I_x$  source is stored in local memory.

Once the resistance value is calculated, the value is linearized in order to convert it to a temperature value. The measurement is returned by software as a 32-bit floating point value in a voltage, resistance or temperature format.

## Data linearization

An on-board microcontroller automatically performs linearization on RTD and thermistor measurements.

- RTD measurements are linearized using a Callendar-Van Dusen coefficients algorithm (you select DIN, SAMA, or ITS-90).
- Thermistor measurements are linearized using a Steinhart-Hart linearization algorithm (you supply the coefficients from the sensor manufacturer's data sheet).

## USB connector

The USB connector provides +5V power and communication. No external power supply is required.

## LED

The LED indicates the communication status of the OM-USB-TEMP-AI. It uses up to 5 mA of current. The table below defines the function of the OM-USB-TEMP-AI LED.

LED Illumination

LED Illumination	Indication
Steady green	The OM-USB-TEMP-AI is connected to a computer or external USB hub.
Pulsing green	Data is being transferred. Upon connection, the LED should flash three times and then remain lit (indicates a successful installation).

## Power

The **+5V** terminal is isolated (500 VDC) from the USB +5V.

**Caution!** The +5V terminal is an output terminal. Do not connect to an external power supply or you may damage the OM-USB-TEMP-AI and possibly the computer.

## Specifications

All specifications are subject to change without notice.

Typical for 25 °C unless otherwise specified.

All specifications apply to all temperature and voltage input channels unless otherwise specified.

Specifications in *italic* text are guaranteed by design.

### Analog input

Table 1. Generic analog input specifications

Parameter	Conditions	Specification
A/D converter type	T0x-T3x, V0x-V3x	AD42_321 Dual 24-bit Sigma-Delta
Number of channels	Voltage input V0x-V3x	4 differential 4 single-ended
	Temperature input T0x-T3x	4 differential
<i>Input isolation</i>		<i>500 VDC minimum between field wiring and USB interface</i>
Channel configuration	T0x-T3x	Temperature input. Software programmable to match sensor type
	V0x-V3x	Voltage input
Analog input modes	Power up and reset state	Factory default configuration is Disabled mode. Once configured, each channel reverts to the mode previously set by the user.
	Single-ended	V <sub>x_H</sub> inputs are connected directly to their screw terminal pins. V <sub>x_L</sub> inputs are disconnected from their screw terminal pins and internally connected to GND.
	Differential	V <sub>x_H</sub> and V <sub>x_L</sub> inputs are connected directly to their screw terminal pins. Tx <sub>H</sub> and Tx <sub>L</sub> inputs are connected directly to their screw terminal pins.
Input ranges	Thermocouple T0x-T3x	±0.080 V
	RTD T0x-T3x	0 to 0.5 V
	Thermistor T0x-T3x	0 to 2 V
	Semiconductor sensor T0x-T3x	0 to 2.5 V
	Voltage V0x-V3x	±10 V, ±5 V, ±2.5 V, ±1.25 V software selectable
<i>Absolute maximum input voltage</i>	<i>T0x-T3x relative to GND (pins 9, 19, 22, 27, 30, 33, 36, 39, 49)</i>	<i>±25 V maximum (power on) ±40 V maximum (power off)</i>
	<i>V0x-V3x relative to GND (pins 9, 19, 22, 27, 30, 33, 36, 39, 49)</i>	<i>±25 V maximum (power on) ±15 V maximum (power off)</i>
<i>Input impedance</i>	<i>T0x-T3x</i>	<i>5 Gigohm (power on) 1 Mohm (power off)</i>

Parameter	Conditions	Specification
	V0x-V3x	10 Gohm (power on) 2.49 kohm (power off)
Input leakage current	T0x-T3x, with open thermocouple detect disabled.	30 nA maximum
	T0x-T3x, with open thermocouple detect enabled.	105 nA maximum
	V0x-V3x	$\pm 1.5$ nA typical., $\pm 25$ nA maximum
Input bandwidth (-3 dB)	T0x-T3x	50 Hz
	V0x-V3x	3 kHz
Maximum working voltage (signal + common mode)	V0x-V3x	$\pm 10.25$ V maximum
Common mode rejection ratio	T0x-T3x, $f_{IN} = 60$ Hz	100 dB
	V0x-V3x, $f_{IN} = 60$ Hz, all input ranges	83 dB
ADC Resolution		24 bits
ADC No missing codes		24 bits
Input coupling		DC
Warm-up time		30 minutes minimum
Open thermocouple detect	T0x-T3x	Automatically enabled when the channel pair is configured for thermocouple sensor. The maximum open detection time is 3 seconds.
CJC sensor accuracy	T0x-T3x, 15 °C to 35 °C	$\pm 0.25$ °C typical, $\pm 0.5$ °C maximum
	T0x-T3x, 0 °C to 70 °C	-1.0 to +0.75 °C maximum

## Channel configurations

Table 2. Channel configuration specifications

Channel	Category	Conditions	Max number of sensors (all channels configured alike)
T0x-T3x	Disabled	All temperature input channels are disconnected from screw terminals and internally connected to GND.	See Note 4
T0x-T3x	Thermocouple (Note 1)		4 differential channels
T0x-T3x	Semiconductor sensor (Note 1)		4 differential channels
T0x-T3x	RTD and Thermistor (Note 1)	2-wire input configuration with a single sensor per channel pair	2 differential channels
		2-wire input configuration with two sensors per channel pair	4 differential channels
		3-wire configuration with a single sensor per channel pair	2 differential channels
		4-wire input configuration with a single sensor per channel pair	2 differential channels
		4-wire input configuration with two sensors per channel pair	4 differential channels
V0x-V3x	Disabled	All voltage input channels are disconnected from screw terminals and internally connected to GND.	See Note 4
V0x-V3x	Differential (Note 2)		4 differential channels
V0x-V3x	Single-ended		4 single-ended channels

- Note 1:** Internally, the OM-USB-TEMP-AI has four, dual-channel, fully differential A/Ds providing a total of eight input channels. The temperature input channels are configured as two channel pairs with T0x/T1x and T2x/T3x accepting temperature sensor type inputs. This "channel-pairing" requires T0x/T1x, and T2x/T3x to be configured to monitor the same category of temperature sensor. Mixing different sensor types of the same category (such as a type J thermocouple on temperature channel 0 and a type T thermocouple on temperature channel 1) is valid.
- Note 2:** The voltage input channels, channels V0x, V1x, V2x, and V3x are *not* configured as channel pairs. Therefore each channel can be configured independently. When connecting differential inputs to floating input sources, you must provide a DC return path from each differential input to ground. To do this, simply connect a resistor from each of the differential inputs to GND. A value of approximately 1Meg ohm can be used for most applications.
- Note 3:** Channel configuration information is stored in the EEPROM of the isolated microcontroller by the firmware whenever any item is modified. Modification is performed by commands issued over USB from an external application, and the configuration is made non-volatile through the use of the EEPROM.
- Note 4:** The factory default configuration is **Disabled**. The Disabled mode disconnects the temperature and voltage inputs from the terminal blocks, and internally connects ground (GND) to all of the A/D inputs. This mode also disables each of the current excitation sources.

## Compatible sensors: T0x-T3x

Table 3. Compatible sensor type specifications

Parameter	Conditions
Thermocouple	J: -210 °C to 1200 °C
	K: -270 °C to 1372 °C
	R: -50 °C to 1768 °C
	S: -50 °C to 1768 °C
	T: -270 °C to 400 °C
	N: -270 °C to 1300 °C
	E: -270 °C to 1000 °C
	B: 0 °C to 1820 °C
RTD	100 ohm PT (DIN 43760: 0.00385 ohms/ohm/°C)
	100 ohm PT (SAMA: 0.003911 ohms/ohm/°C)
	100 ohm PT (ITS-90/IEC751:0.0038505 ohms/ohm/°C)
Thermistor	Standard 2,252 ohm through 30,000 ohm
Semiconductor / IC	TMP36 or equivalent

## Accuracy

### Thermocouple measurement accuracy: T0x-T3x

Table 4. Thermocouple accuracy specifications, including CJC measurement error. All specifications are (±).

Sensor Type	Sensor temperature range	Accuracy error maximum (°C)	Accuracy error typical (°C)	Tempco (°C/°C)
J	-210 °C	2.028	0.707	0.031
	0 °C	0.835	0.278	
	1200 °C	0.783	0.288	
K	-210 °C	2.137	0.762	0.035
	0 °C	0.842	0.280	
	1372 °C	0.931	0.389	
S	-50 °C	1.225	0.435	0.021
	250 °C	0.554	0.195	
	1768 °C	0.480	0.157	
R	-50 °C	1.301	0.458	0.019
	250 °C	0.549	0.190	
	1768 °C	0.400	0.134	
B	250 °C	2.193	2.185	0.001
	700 °C	0.822	0.819	
	1820 °C	0.469	0.468	
E	-200 °C	1.976	0.684	0.030
	0 °C	0.954	0.321	
	1000 °C	0.653	0.240	
T	-200 °C	2.082	0.744	0.035
	0 °C	0.870	0.290	
	400 °C	0.568	0.208	
N	-200 °C	2.197	0.760	0.028
	0 °C	0.848	0.283	
	1300 °C	0.653	0.245	



- Note 5:** Thermocouple measurement accuracy specifications include polynomial linearization, cold-junction compensation and system noise. These specs are for one year, or 3000 operating hours, whichever comes first, and for operation of the OM-USB-TEMP-AI between 15 °C and 35 °C. There is a CJC sensor on each temperature sensor input side of the module. The accuracy listed above assumes the screw terminals are at the same temperature as the CJC sensor. Errors shown do not include inherent thermocouple error. Contact your thermocouple supplier for details on the actual thermocouple accuracy error.
- Note 6:** Thermocouples must be connected to the OM-USB-TEMP-AI such that they are floating with respect to GND (pins 9, 19, 22, 27, 30, 33, 36, 39, 49). The OM-USB-TEMP-AI GND pins are isolated from earth ground. You can connect thermocouple sensors to voltages referenced to earth ground as long as the isolation between the GND pins and earth ground is maintained.
- Note 7:** When thermocouples are attached to conductive surfaces, the voltage differential between multiple thermocouples must remain within  $\pm 1.4$  V. For best results, we recommend using insulated or ungrounded thermocouples when possible.

### Semiconductor sensor measurement accuracy: T0x-T3x

Table 5. Semiconductor sensor accuracy specifications

Sensor type	Temperature Range	Accuracy Error maximum
TMP36 or equivalent	-40 to 150 °C	$\pm 0.50$ °C

- Note 8:** Error shown does not include errors of the sensor itself. These specifications are for one year while operation of the OM-USB-TEMP-AI unit is between 15 °C and 35 °C. Contact your sensor supplier for details on the actual sensor error limitations.

### RTD measurement accuracy: T0x-T3x

Table 6. RTD measurement accuracy specifications,  $I_{x+} = 210$   $\mu$ A. All specifications are ( $\pm$ ).

RTD	Sensor temperature range	Accuracy error (°C) maximum	Accuracy error (°C) typical	Tempco (°C/°C)
PT100, DIN, US or ITS-90	-200 °C	2.913	2.784	0.001
	-150 °C	1.201	1.070	0.001
	-100 °C	0.482	0.349	0.001
	0 °C	0.261	0.124	0.001
	100 °C	0.269	0.127	0.001
	300 °C	0.287	0.136	0.001
	600 °C	0.318	0.150	0.001

- Note 9:** The error shown does not include errors of the sensor itself. The sensor linearization is performed using a Callendar-Van Dusen linearization algorithm. The accuracy and tempco specifications include the accuracy of the Callendar-Van Dusen linearization algorithm. These specifications are for one year while operation of the OM-USB-TEMP-AI unit is between 15 °C and 35 °C. The specification does not include lead resistance errors for 2-wire RTD connections. Please contact your sensor supplier for details on the actual sensor error limitations.
- Note 10:** Resistance values greater than 660 ohms cannot be measured by the OM-USB-TEMP-AI in the RTD mode. The 660 ohm resistance limit includes the total resistance across the current excitation ( $\pm I_x$ ) pins, which is the sum of the RTD resistance and the lead resistances.
- Note 11:** For accurate three wire compensation, the individual lead resistances connected to the  $\pm I_x$  pins must be of equal ohmic value. To ensure this, use connection leads of equal lengths.

## Thermistor measurement accuracy: T0x-T3x

Table 7. Thermistor measurement accuracy specifications,  $I_{x+} = 10 \mu\text{A}$ . All specifications are ( $\pm$ )

Thermistor	Sensor temperature range	Accuracy error maximum ( $^{\circ}\text{C}$ )	Accuracy error typical ( $^{\circ}\text{C}$ )	Tempco ( $^{\circ}\text{C}/^{\circ}\text{C}$ )
2252 _	-40 $^{\circ}\text{C}$	0.001	0.0007	0.001
	0 $^{\circ}\text{C}$	0.021	0.008	0.001
	50 $^{\circ}\text{C}$	0.263	0.130	0.001
	120 $^{\circ}\text{C}$	3.473	1.750	0.001
5000 _	-35 $^{\circ}\text{C}$	0.001	0.0006	0.001
	0 $^{\circ}\text{C}$	0.009	0.004	0.001
	50 $^{\circ}\text{C}$	0.115	0.049	0.001
	120 $^{\circ}\text{C}$	1.535	0.658	0.001
10000 _	-25 $^{\circ}\text{C}$	0.001	0.0005	0.001
	0 $^{\circ}\text{C}$	0.005	0.002	0.001
	50 $^{\circ}\text{C}$	0.060	0.028	0.001
	120 $^{\circ}\text{C}$	0.771	0.328	0.001
30000 _	-10 $^{\circ}\text{C}$	0.001	0.0005	0.001
	0 $^{\circ}\text{C}$	0.002	0.001	0.001
	50 $^{\circ}\text{C}$	0.019	0.009	0.001
	120 $^{\circ}\text{C}$	0.267	0.128	0.001

**Note 12:** Error shown does not include errors of the sensor itself. The sensor linearization is performed using a Steinhart-Hart linearization algorithm. The accuracy and tempco specifications *include* the accuracy of the Callendar-Van Dusen linearization algorithm. These specifications are for one year while operation of the OM-USB-TEMP-AI unit is between 15  $^{\circ}\text{C}$  and 35  $^{\circ}\text{C}$ . The specification does not include lead resistance errors for 2-wire thermistor connections. Contact your sensor supplier for details on the actual sensor error limitations. Total thermistor resistance on any given channel pair must not exceed 180k ohms. Typical resistance values at various temperatures for supported thermistors are shown in Table 8.

Table 8. Typical thermistor resistance measurement range

Temp	2252 _ thermistor	3000 _ thermistor	5 k_ thermistor	10 k_ thermistor	30 k_ thermistor
-40 $^{\circ}\text{C}$	76 k_	101 k_	168 k_	240 k_ (Note 13)	885 k_ (Note 13)
-35 $^{\circ}\text{C}$	55 k_	73 k_	121 k_	179 k_	649 k_ (Note 13)
-30 $^{\circ}\text{C}$	40 k_	53 k_	88 k_	135 k_	481 k_ (Note 13)
-25 $^{\circ}\text{C}$	29 k_	39 k_	65 k_	103 k_	360 k_ (Note 13)
-20 $^{\circ}\text{C}$	22 k_	29 k_	49 k_	79 k_	271 k_ (Note 13)
-15 $^{\circ}\text{C}$	16 k_	22 k_	36 k_	61 k_	206 k_ (Note 13)
-10 $^{\circ}\text{C}$	12 k_	17 k_	28 k_	48 k_	158 k_
-5 $^{\circ}\text{C}$	9.5 k_	13 k_	21 k_	37 k_	122 k_
0 $^{\circ}\text{C}$	7.4 k_	9.8 k_	16 k_	29 k_	95 k_

**Note 13:** Resistance values greater than 180 k ohms cannot be measured by the OM-USB-TEMP-AI in the thermistor mode. The 180 k ohm resistance limit includes the total resistance across the current excitation ( $\pm I_x$ ) pins, which is the sum of the thermistor resistance and the lead resistances.

**Note 14:** For accurate three wire compensation, the individual lead resistances connected to the  $\pm I_x$  pins must be of equal ohmic value. To ensure this, use connection leads of equal lengths.

## Absolute Accuracy: V0x-V3x

Table 9. Calibrated absolute accuracy specifications

Range	Absolute Accuracy (mV)
±10 V	±2.779
±5 V	±1.398
±2.5 V	±0.707
±1.25 V	±0.362

**Note 15:** When connecting differential inputs to floating input sources, the user must provide a ground return path from each differential input to ground. To do this, simply connect a resistor from each of the differential inputs to GND. A value of approximately 1 Meg ohm can be used for most applications.

**Note 16:** All ground pins on the OM-USB-TEMP-AI (pins 9, 19, 22, 27, 30, 33, 36, 39, 49) are common and are isolated from earth ground. If a connection is made to earth ground when using both voltage inputs and conductive thermocouples, the thermocouples are no longer isolated. In this case, thermocouples must not be connected to any conductive surfaces that may be referenced to earth ground

**Note 17:** Unused voltage inputs should not be left floating. These inputs should be placed in the Disabled mode or connected to GND.

Table 10. Accuracy components. All values are (±)

Range	Gain error (% of reading)	Offset error (µV)	INL error (% of range)	Gain Temperature Coefficient (ppm/°C)	Offset Temperature Coefficient (µV/°C)
±10 V	0.0246	16.75	0.0015	3.68	0.42
±5 V	0.0246	16.75	0.0015	3.68	0.42
±2.5 V	0.0246	16.75	0.0015	3.68	0.42
±1.25 V	0.0246	16.75	0.0015	3.68	0.42

Table 11. Noise performance specifications

Range	Peak to peak noise (µV)	RMS noise (µVrms)	Noise-Free resolution (bits)
±10 V	41.13	6.23	19.09
±5 V	30.85	4.67	18.51
±2.5 V	17.14	2.60	18.36
±1.25 V	11.14	1.69	17.98

Table 11 summarizes the noise performance for the OM-USB-TEMP-AI. Noise distribution is determined by gathering 1000 samples with inputs tied to ground at the user connector. Samples are gathered at the maximum specified sample rate of 2 S/s.

## Settling time: V0x-V3x

Table 12. Settling time specifications

Range	Accuracy
	$\pm 0.0004\%$ (seconds)
$\pm 10$ V	15.0
$\pm 5$ V	0.40
$\pm 2.5$ V	0.40
$\pm 1.25$ V	0.40

Settling time is defined as the time required for a channel to settle within a specified accuracy in response to a full-scale (FS) step input.

## Analog input calibration

Table 13. Analog input calibration specifications

Parameter	Specifications
Recommended warm-up time	30 minutes minimum
Calibration	Firmware calibration
Calibration interval	1 year
Calibration reference	+10.000 V, $\pm 5$ mV maximum. Actual measured values stored in EEPROM
	Tempco: 5 ppm/ $^{\circ}$ C maximum
	Long term stability: 30 ppm/1000 h

## Throughput rate

Table 14. Throughput rate specifications

Number of Input Channels	Maximum throughput
1	2 Samples/second
2	2 S/s on each channel, 4 S/s total
3	2 S/s on each channel, 6 S/s total
4	2 S/s on each channel, 8 S/s total
5	2 S/s on each channel, 10 S/s total
6	2 S/s on each channel, 12 S/s total
7	2 S/s on each channel, 14 S/s total
8	2 S/s on each channel, 16 S/s total

**Note 18:** The analog inputs are configured to run continuously. Each channel is sampled twice per second. The maximum latency between when a sample is acquired and the voltage/temperature data is provided by the USB unit is approximately 0.4 seconds.

## Digital input/output

Table 15. Digital input/output specifications

Digital type	5V CMOS
Number of I/O	8 (DIO0 through DIO7)
Configuration	Independently configured for input or output. Power on reset is input mode.
Pull-up/pull-down configuration	All pins pulled up to +5 V via 47 K resistors (default). Contact MCC factory for pull-down to ground (GND) capability.
Digital I/O transfer rate (software paced)	Digital input – 50 port reads or single bit reads per second typical. Digital output – 100 port writes or single bit writes per second typical.
Input high voltage	2.0 V minimum, 5.5 V absolute maximum.
Input low voltage	0.8 V maximum, –0.5 V absolute minimum
Output low voltage (IOL = 2.5 mA max.)	0.7 V maximum
Output high voltage (IOH = –2.5 mA max.)	3.8 V minimum

**Note 19:** All ground pins on the OM-USB-TEMP-AI (pins 9, 19, 22, 27, 30, 33, 36, 39, 49) are common and are isolated from earth ground. If a connection is made to earth ground when using both digital I/O and conductive thermocouples, the thermocouples are no longer isolated. In this case, thermocouples must not be connected to any conductive surfaces that may be referenced to earth ground.

## Counter

Table 16. CTR I/O specifications

Parameter	Conditions	Specification
Pin name		CTR
Number of channels		1
Resolution		32-bits
Counter type		Event counter
Input type		TTL, rising edge triggered
Input source		CTR screw terminal
Counter read/writes rates (software paced)	Counter read	System dependent, 33 to 1000 reads per second.
	Counter write	System dependent, 33 to 1000 reads per second.
Schmidt trigger hysteresis		20 mV to 100 mV
<i>Input leakage current</i>		$\pm 1.0 \mu\text{A typ.}$
Input frequency		1 MHz max.
<i>High pulse width</i>		500 nS min.
<i>Low pulse width</i>		500 ns min.
Input high voltage		4.0 V min, 5.5 V absolute max
Input low voltage		1.0 V max, –0.5 V absolute min

**Note 20:** All ground pins on the OM-USB-TEMP-AI (pins 9, 19, 22, 27, 30, 33, 36, 39, 49) are common and are isolated from earth ground. If a connection is made to earth ground with both the counter (CTR) and conductive thermocouples, the thermocouples are no longer isolated. In this case, thermocouples must not be connected to any conductive surfaces that may be referenced to earth ground.

## Memory

Table 17. Memory specifications

EEPROM	1,024 bytes isolated micro reserved for sensor configuration 256 bytes USB micro for external application use
--------	--

## Microcontroller

Table 18. Microcontroller specifications

Type	Two high-performance 8-bit RISC microcontrollers
------	--

## USB +5V voltage

Table 19. USB +5V voltage specifications

Parameter	Specification
USB +5V (VBUS) input voltage range	4.75 V minimum to 5.25 V maximum

## Power

Table 20. Power specifications

Parameter	Conditions	Specification
Supply current	USB enumeration	<100 mA
Supply current (Note 21)	Quiescent mode with all inputs configured for Disabled mode	270 mA typical
User +5V output voltage range (terminal block pin 21)		4.9 V minimum to 5.1 V maximum
User +5V output current (terminal block pin 21)	Bus-powered and connected to a self-powered hub. (Note 21)	5 mA maximum
Isolation	Measurement system to PC	500 VDC minimum

**Note 21:** This is the total current requirement for the OM-USB-TEMP-AI which includes up to 10 mA for the status LED.

## USB specifications

Table 21. USB specifications

USB device type	USB 2.0 (full-speed)
Device compatibility	USB 1.1, USB 2.0
Device power capability	Self-powered
USB cable type	A-B cable, UL type AWM 2527 or equivalent. (min 24 AWG VBUS/GND, min 28 AWG D+/D-)
USB cable length	3 meters maximum

## Current excitation outputs ( $\pm I_x$ , T0x-T3x)

Table 22. Current excitation output specifications

Parameter	Conditions	Specification
Configuration		2 dedicated pairs: $\pm I1$ : T0x/T1x $\pm I2$ : T2x/T3x
Current excitation output ranges	Thermistor	10 $\mu A$
	RTD	210 $\mu A$
Tolerance		$\pm 5.0\%$
Drift		200 ppm/ $^{\circ}C$
Line regulation		2.1 ppm/V maximum
Load regulation		0.3 ppm/V
Output compliance voltage (relative to GND pins 9, 19, 22, 27, 30, 33, 36, 39)		3.90 V maximum -0.03 V minimum

**Note 22:** The OM-USB-TEMP-AI has two current excitation outputs, with  $\pm I1$  dedicated to the T0x/T1x analog inputs, and  $\pm I2$  dedicated to T2x/T3x. The excitation output currents should always be used in this dedicated configuration.

**Note 23:** The current excitation outputs are automatically configured based on the sensor (thermistor or RTD) selected.

## Environmental

Table 23. Environmental specifications

Operating temperature range	0 to 55 $^{\circ}C$ maximum
Storage temperature range	-40 to 85 $^{\circ}C$ maximum
Humidity	0 to 90% non-condensing maximum

## Mechanical

Table 24. Mechanical specifications

Dimensions	127 mm (L) x 88.9 mm (W) x 35.56 (H)
User connection length	3 meters maximum

## Screw terminal connector type and pin out

Table 25. Screw terminal connector specifications

Connector type	Screw terminal
Wire gauge range	16 AWG to 30 AWG

## Screw terminal pin out

Table 26. Screw terminal pin out

Pin	Signal Name	Pin Description	Pin	Signal Name	Pin Description
1	I1+	T0/T1 current excitation source	27	GND	
2	NC		28	V3L	V3 voltage input (-)
3	T0H	T0 sensor input (+)	29	V3H	V3 voltage input (+)
4	T0L	T0 sensor input (-)	30	GND	
5	4W01	T0/T1 4-wire, 2 sensor common	31	V2L	V2 voltage input (-)
6	IT01	T0/T1 2-sensor common	32	V2H	V2 voltage input (+)
7	T1H	T1 sensor input (+)	33	GND	
8	T1L	T1 sensor input (-)	34	V1L	V1 voltage input (-)
9	GND		35	V1H	V1 voltage input (+)
10	I1-	T0/T1 current excitation return	36	GND	
	CJC sensor				
11	I2+	T2/T3 current excitation source	37	V0L	V0 voltage input (-)
12	NC		38	V0H	V0 voltage input (+)
13	T2H	T2 sensor input (+)	39	GND	
14	T2L	T2 sensor input (-)	40	CTR	Counter Input
15	4W23	T2/T3 4-wire, 2 sensor common	41	DIO7	Digital Input/Output
16	IT23	T2/T3 2 sensor common	42	DIO6	Digital Input/Output
17	T3H	T3 sensor input (+)	43	DIO5	Digital Input/Output
18	T3L	T3 sensor input (-)	44	DIO4	Digital Input/Output
19	GND		45	DIO3	Digital Input/Output
20	I2-	T2/T3 current excitation return	46	DIO2	Digital Input/Output
21	+5V	+5V output	47	DIO1	Digital Input/Output
22	GND		48	DIO0	Digital Input/Output
23	NC		49	GND	
24	NC		50	NC	
25	NC		51	NC	
26	NC		52	NC	



## WARRANTY/DISCLAIMER

OMEGA ENGINEERING, INC. warrants this unit to be free of defects in materials and workmanship for a period of **13 months** from date of purchase. OMEGA's WARRANTY adds an additional one (1) month grace period to the normal **one (1) year product warranty** to cover handling and shipping time. This ensures that OMEGA's customers receive maximum coverage on each product.

If the unit malfunctions, it must be returned to the factory for evaluation. OMEGA's Customer Service Department will issue an Authorized Return (AR) number immediately upon phone or written request. Upon examination by OMEGA, if the unit is found to be defective, it will be repaired or replaced at no charge. OMEGA's WARRANTY does not apply to defects resulting from any action of the purchaser, including but not limited to mishandling, improper interfacing, operation outside of design limits, improper repair, or unauthorized modification. This WARRANTY is VOID if the unit shows evidence of having been tampered with or shows evidence of having been damaged as a result of excessive corrosion; or current, heat, moisture or vibration; improper specification; misapplication; misuse or other operating conditions outside of OMEGA's control. Components in which wear is not warranted, include but are not limited to contact points, fuses, and triacs.

**OMEGA is pleased to offer suggestions on the use of its various products. However, OMEGA neither assumes responsibility for any omissions or errors nor assumes liability for any damages that result from the use of its products in accordance with information provided by OMEGA, either verbal or written. OMEGA warrants only that the parts manufactured by the company will be as specified and free of defects. OMEGA MAKES NO OTHER WARRANTIES OR REPRESENTATIONS OF ANY KIND WHATSOEVER, EXPRESSED OR IMPLIED, EXCEPT THAT OF TITLE, AND ALL IMPLIED WARRANTIES INCLUDING ANY WARRANTY OF MERCHANTABILITY AND FITNESS FOR A PARTICULAR PURPOSE ARE HEREBY DISCLAIMED. LIMITATION OF LIABILITY: The remedies of purchaser set forth herein are exclusive, and the total liability of OMEGA with respect to this order, whether based on contract, warranty, negligence, indemnification, strict liability or otherwise, shall not exceed the purchase price of the component upon which liability is based. In no event shall OMEGA be liable for consequential, incidental or special damages.**

CONDITIONS: Equipment sold by OMEGA is not intended to be used, nor shall it be used: (1) as a "Basic Component" under 10 CFR 21 (NRC), used in or with any nuclear installation or activity; or (2) in medical applications or used on humans. Should any Product(s) be used in or with any nuclear installation or activity, medical application, used on humans, or misused in any way, OMEGA assumes no responsibility as set forth in our basic WARRANTY/DISCLAIMER language, and, additionally, purchaser will indemnify OMEGA and hold OMEGA harmless from any liability or damage whatsoever arising out of the use of the Product(s) in such a manner.

## RETURN REQUESTS/INQUIRIES

Direct all warranty and repair requests/inquiries to the OMEGA Customer Service Department. BEFORE RETURNING ANY PRODUCT(S) TO OMEGA, PURCHASER MUST OBTAIN AN AUTHORIZED RETURN (AR) NUMBER FROM OMEGA'S CUSTOMER SERVICE DEPARTMENT (IN ORDER TO AVOID PROCESSING DELAYS). The assigned AR number should then be marked on the outside of the return package and on any correspondence.

The purchaser is responsible for shipping charges, freight, insurance and proper packaging to prevent breakage in transit.

FOR **WARRANTY** RETURNS, please have the following information available BEFORE contacting OMEGA:

1. Purchase Order number under which the product was PURCHASED,
2. Model and serial number of the product under warranty, and
3. Repair instructions and/or specific problems relative to the product.

FOR **NON-WARRANTY** REPAIRS, consult OMEGA for current repair charges. Have the following information available BEFORE contacting OMEGA:

1. Purchase Order number to cover the COST of the repair,
2. Model and serial number of the product, and
3. Repair instructions and/or specific problems relative to the product.

OMEGA's policy is to make running changes, not model changes, whenever an improvement is possible. This affords our customers the latest in technology and engineering.

OMEGA is a registered trademark of OMEGA ENGINEERING, INC.

© Copyright 2010 OMEGA ENGINEERING, INC. All rights reserved. This document may not be copied, photocopied, reproduced, translated, or reduced to any electronic medium or machine-readable form, in whole or in part, without the prior written consent of OMEGA ENGINEERING, INC.

# Where Do I Find Everything I Need for Process Measurement and Control?

**OMEGA...Of Course!**

***Shop online at [omega.com](http://omega.com)<sup>SM</sup>***

## **TEMPERATURE**

- ☑ Thermocouple, RTD & Thermistor Probes, Connectors, Panels & Assemblies
- ☑ Wire: Thermocouple, RTD & Thermistor
- ☑ Calibrators & Ice Point References
- ☑ Recorders, Controllers & Process Monitors
- ☑ Infrared Pyrometers

## **PRESSURE, STRAIN AND FORCE**

- ☑ Transducers & Strain Gages
- ☑ Load Cells & Pressure Gages
- ☑ Displacement Transducers
- ☑ Instrumentation & Accessories

## **FLOW/LEVEL**

- ☑ Rotameters, Gas Mass Flowmeters & Flow Computers
- ☑ Air Velocity Indicators
- ☑ Turbine/Paddlewheel Systems
- ☑ Totalizers & Batch Controllers

## **pH/CONDUCTIVITY**

- ☑ pH Electrodes, Testers & Accessories
- ☑ Benchtop/Laboratory Meters
- ☑ Controllers, Calibrators, Simulators & Pumps
- ☑ Industrial pH & Conductivity Equipment

## **DATA ACQUISITION**

- ☑ Data Acquisition & Engineering Software
- ☑ Communications-Based Acquisition Systems
- ☑ Plug-in Cards for Apple, IBM & Compatibles
- ☑ Data Logging Systems
- ☑ Recorders, Printers & Plotters

## **HEATERS**

- ☑ Heating Cable
- ☑ Cartridge & Strip Heaters
- ☑ Immersion & Band Heaters
- ☑ Flexible Heaters
- ☑ Laboratory Heaters

## **ENVIRONMENTAL MONITORING AND CONTROL**

- ☑ Metering & Control Instrumentation
- ☑ Refractometers
- ☑ Pumps & Tubing
- ☑ Air, Soil & Water Monitors
- ☑ Industrial Water & Wastewater Treatment
- ☑ pH, Conductivity & Dissolved Oxygen Instruments