

1 YEAR
WARRANTY

MADE IN
USA

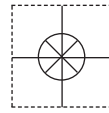

Ω OMEGA® User's Guide



*Shop online at
omega.com®*

*e-mail: info@omega.com
For latest product manuals:
omegamanual.info*

ISO 9001
CERTIFIED
CORPORATE QUALITY
STAMFORD, CT

ISO 9001
CERTIFIED
CORPORATE QUALITY
MANCHESTER, UK

DTG-RTD 100 SERIES Digital Temperature Gauge



OMEGAnet® Online Service
omega.com

Internet e-mail
info@omega.com

Servicing North America:

U.S.A.:
ISO 9001 Certified
Omega Engineering, Inc., One Omega Drive, P.O. Box 4047
Stamford, CT 06907-0047 USA
Toll Free: 1-800-826-6342 TEL: (203) 359-1660
FAX: (203) 359-7700 e-mail: info@omega.com

Canada:
976 Berar
Laval (Quebec), H7L 5A1, Canada
Toll-Free: 1-800-826-6342 TEL: (514) 856-6928
FAX: (514) 856-6886 e-mail: info@omega.ca

For immediate technical or application assistance:

U.S.A. and Canada: Sales Service: 1-800-826-6342 / 1-800-TC-OMEGA®
Customer Service: 1-800-622-2378 / 1-800-622-BEST®
Engineering Service: 1-800-872-9436 / 1-800-USA-WHEN®

**Mexico/
Latin America:** TEL: 001 (203) 359-1660 FAX: 001 (203) 359-7700
e-mail: espanol@omega.com

Servicing Asia:

China:
1698 Yi Shan Road, Unit 102
Min Hang District
Shanghai, China 201103 P.R.C.
Hotline: 800 819 0559 / 400 619 0559
e-mail: info@cn.omega.com

Servicing Europe:

Benelux: Toll-Free: 0800 099 3344 TEL: +31 20 347 21 21
FAX: +31 20 643 46 43 e-mail: sales@omegaeng.nl

Czech Republic: Frystatska 184
733 01 Karviná, Czech Republic
TEL: +420-59-6311899 FAX: +420-59-6311114
e-mail: info@omegashop.cz

France: Toll-Free: 0800 541 038 TEL: 01 57 32 48 17
FAX: 01 57 32 48 18 e-mail: esales@omega.fr

Germany/ Austria: Daimlerstrasse 26
D-75392 Deckenpfronn, Germany
Toll-Free: 0800 8266342 TEL: +49 (0) 7056 9398-0
FAX: +49 (0) 7056 9398-29 e-mail: info@omega.de

United Kingdom: OMEGA Engineering Ltd.
ISO 9001 Certified One Omega Drive, River Bend Technology Centre, Northbank
Irlam, Manchester M44 5BD United Kingdom
Toll-Free: 0800-488-488 TEL: +44 (0) 161 777-6611
FAX: +44 (0) 161 777-6622 e-mail: sales@omega.co.uk

It is the policy of OMEGA Engineering, Inc. to comply with all worldwide safety and EMC/EMI regulations that apply. OMEGA is constantly pursuing certification of its products to the European New Approach Directives. OMEGA will add the CE mark to every appropriate device upon certification.

The information contained in this document is believed to be correct, but OMEGA accepts no liability for any errors it contains, and reserves the right to alter specifications without notice.

WARNING: These products are not designed for use in, and should not be used for, human applications.

	Page
Section 1 - Introduction	1-1
1.1 Precautions	1-1
1.2 Statement on FCC and CE Marking.....	1-2
1.3 General Description	1-2
Section 2 - Hardware	2-1
2.1 Unpacking and Inspection	2-1
2.2 Included Items	2-1
Section 3 - Setup & Configuration	3-1
3.1 Getting Started	3-1
3.2 Software Utility	3-1
3.3 Software Installation	3-1
3.4 Configuration	3-4
Section 4 - Installation, Mounting & Wiring	4-1
4.1 Installation	4-1
4.2 Ambient Temperature	4-1
4.3 General Meter Dimensions	4-1
4.4 Battery Installation/Replacement	4-2
4.5 Mounting	4-3
4.6 Wiring (Sensor, Power, Analog Output)	4-4
Section 5 - Display Features & Meter Operation	5-1
5.1 Display Features	5-1
5.2 Keypad Operation	5-1
Section 6 - Optional Wireless Transmitter Operation	6-1
6.1 Introduction	6-1
6.2 RF Communication Basics	6-1
6.3 Basic System Overview	6-1
6.4 Transmit Rate vs. Battery Life	6-3
6.5 Wireless Transmitter Setup	6-6
Section 7 - DTG-RTD100 Design for CE Conformity	7-1
7.1 DTG-RTD100 Analog Output Grounding	7-1
7.2 Ferrite Cores	7-2
Section 8 - Service and Calibration	8-1
Section 9 - Specifications	9-1
9.1 General	9-1
9.2 Wireless Option	9-1
Section 10 - Approvals, Regulatory Compliance	10-1

List of Figures

Section	Figure	Description	Page
Section 1.1	1-1	Rear Label Standard	1-1
Section 1-1	1-2	Rear Label Wireless	1-1
Section 3.3	3-1	Software - Welcome Screen	3-1
Section 3.3	3-2	Software - Installation Options Screen.....	3-2
Section 3.3	3-3	Software - Select Installation Folder Screen	3-2
Section 3.3	3-4	Software - License Agreement Screen	3-3
Section 3.3	3-5	Software - Installation Complete Screen.....	3-3
Section 3.4	3-6	Lid/Cover Removal	3-4
Section 3.4	3-7	USB Programming Cable	3-5
Section 3.4	3-8	USB Connector Location	3-5
Section 3.4	3-9	Launch Setup Utility Screen	3-5
Section 3.4	3-10	Utility Program - Welcome Screen.....	3-6
Section 3.4	3-11	Utility Program - Connect To Digital Gauge Screen	3-6
Section 3.4	3-12	Utility Program - Verify Connections Screen	3-7
Section 3.4	3-13	Utility Program - Establish Link Screen.....	3-7
Section 3.4	3-14	Utility Program - Choose Options Screen	3-8
Section 3.4	3-15	Analog Output Options	3-11
Section 3.4	3-16	Calibrations Options Screen - Skip Calibration Option	3-12
Section 3.4	3-17	Calibrations Options Screen - Skip To Next Operation.....	3-13
Section 3.4	3-18	Send Settings To Digital Gauge Screen- Finish Option	3-13
Section 4.3	4-1	General Meter Dimensions	4-1
Section 4.4	4-2	Battery Installation/Replacement	4-2
Section 4.5	4-3	Mounting Bracket Accessory, Model DTG-RTD100-MB	4-3
Section 4.6	4-4	Wiring - Terminal Block Location	4-4
Section 4.6	4-5	Wiring - Temperature Sensor	4-4
Section 4.6	4-6	Wiring - M12 Connector	4-4
Section 4.6	4-7	Wiring - Power Supply	4-5
Section 4.6	4-8	Wiring - Analog Output	4-5
Section 4.6	4-9	Wiring - Alarm	4-6
Section 5.1	5-1	Display Features	5-1
Section 5.2	5-2	Keypad Operation	5-1
Section 5.2	5-3	Magnetic Stylus	5-2
Section 5.2	5-4	Menu Button Operation	5-3, 5-4
Section 5.2	5-5	Front Keypad Set Button	5-5
Section 6.3	6-1	Fresnel Zone	6-1

List of Figures continued

Section 6.4	Table 1	DTG-RTD100 Battery Life - Standard Mode	6-3
Section 6.4	Table 2	DTG-RTD100-W Battery Life - Wireless Mode (2 x 4.8Ah Batteries)	6-4
Section 6.4	Table 3	DTG-RTD100-W Battery Life - Wireless Mode (2 x 8.5Ah Batteries)	6-5
Figure			
Section 7.1	7-1	Analog Output Wiring Example	7-1
Section 7.1	7-2	Analog Output Grounding Example	7-1
Section 7.2	7-3	Ferrite Core	7-1
Section 7.2	7-4	Ferrite Core Installation	7-2



NOTES:

Section 1 - Introduction

Please read this manual completely before installing and operating your instrument. It's important to read and follow all notes, cautions, warnings and safety precautions before setting up, installing and operating this unit.

1.1 Precautions

- This device has not been designed, tested or approved for use in any medical or nuclear applications.
- Never operate this device in flammable or explosive environments.
- Never operate with a power source other than the one recommended in this manual.
- Never operate this device outside of the recommended use outlined in this manual.

For models with wireless transmitter option

- No co-location with other radio transmitters is allowed. By definition, co-location is when another radio device or it's antenna is located within 20 cm of your unit and can transmit simultaneously with your unit.
- Never install a wireless unit within 20 cm or less from each other.
- Never install and /or continuously operate your wireless unit closer than 20 cm to nearby persons.
- Never use your wireless unit as a portable device. Your unit has been designed to be operated in a permanent installation only.

NOTE:

There are no user serviceable parts inside your device. Attempting to repair or service your unit may void your warranty:





MODEL NO.	
<input type="checkbox"/> DTG-RTD100	 
<input type="checkbox"/> DTG-RTD100-M12- <input type="checkbox"/>	NEMA 4 / IP65
<input type="checkbox"/> DTG-RTD100- <input type="text"/>	
SERIAL NO: <input type="text"/>	
 CAUTION: MAY CONTAIN LITHIUM BATTERY, REFER TO MANUAL	
OMEGA ENGINEERING, INC. Stamford, CT 06907	
	

Figure 1-1. Rear Label Standard





MODEL NO.	
<input type="checkbox"/> DTG-RTD100-W	 
<input type="checkbox"/> DTG-RTD100-M12- <input type="checkbox"/> -W	NEMA 4 / IP65
<input type="checkbox"/> DTG-RTD100- <input type="text"/> -W	
SERIAL NO: <input type="text"/>	
 CAUTION: MAY CONTAIN LITHIUM BATTERY, REFER TO MANUAL	
FCC ID: OUR-XBEEPRO IC #4214A-XBEEPRO This device complies with Part 15 of the FCC rules. Operation is subject to the following two conditions: 1) This device may not cause harmful interference; 2) This device must accept any interference received, including interference that may cause undesired operation.	
OMEGA ENGINEERING, INC. Stamford, CT 06907	
	

Figure 1-2. Rear Label Wireless

1.2 Statement on FCC and CE Marking

FCC Marking

FCC ID: OUR-XBEEPRO IC #4214A-XBEEPRO

This device complies with Part 15 of the FCC rules. Operation is subject to the following two conditions: 1.) This device may not cause harmful interference. 2.) This device must accept any interference received, including interference that may cause undesired operation.

CE Marking

It is the policy of OMEGA to comply with all worldwide safety and EMI/EMC regulations that apply. OMEGA is constantly pursuing certification of its products to the European New Approach Directives. OMEGA will add the CE mark to every appropriate device upon certification.

1.3 General Description

OMEGA's new DTG-RTD100 Thermometer Series features a rugged 316 stainless steel enclosure that is designed specifically for wash-down, sanitary and marine applications. The large backlit LCD display incorporates both large 25 mm (1") digits and a 25 segment bar graph that makes reading at distances up to 10.7 m (35') easy. Models are available with or without integral industrial or sanitary temperature sensors. Standard features include: internal battery or external DC power supply operation, analog output and user programmable alarms. The optional built-in wireless transmitter allows for remote monitoring, chart recording and data logging. A variety of user configurable options and settings include: update rate, dampening, units, backlight level, alarm setting, analog output scaling and auto-power-off.

Section 2 – Hardware

It is important that you read this manual completely and follow all safety precautions before operating this instrument.

2.1 Unpacking & Inspection

Remove the packing list and verify that you have received all your equipment. If you have any questions about the shipment, please call our Customer Service Department at 1-800-622-2378 or 203-359-1660. We can also be reached on the Internet at www.omega.com, e-mail: cservice@omega.com. When you receive the shipment, inspect the container and equipment for any signs of damage. Note any evidence of rough handling in transit. Immediately report any damage to the shipping agent.

NOTE:

The carrier will not honor any damage claims unless all shipping material is saved for inspection. After examining and removing contents, save packing material and carton in the event reshipment is necessary.

2.2 Included Items

The following items are supplied in the box.

- 1 DTG-RTD100 Thermometer Assembly
- 1 User's Guide
- 1 USB Programming Cable
- 1 Setup Utility Software Disk
- 2 Ferrite Cores
- 1 Analog Output Grounding Cable

Section 3 – Setup & Configuration

3.1 Getting Started

This section outlines how to setup and configure your DTG-RTD100 Thermometer before installation and use. All configuration settings are set and saved into your meter by connecting the included USB programming cable and running the software utility that was included with your unit on your computer.

3.2 Software Utility

Your computer should meet the following minimum requirements:

- Pentium Class processor
- Hard Drive Space: 210 meg
- Ram: 256 meg or higher
- 1 Available USB Port
- 1 CD-ROM Drive
- Windows 2000, XP, Vista (32bit) Operating System or Windows 7.

3.3 Software Installation

Insert the software CD that was included with your unit into the CD-ROM drive on your PC. Your system should begin the installation process automatically.



Figure 3-1. Software - Welcome Screen

This welcome screen will be visible on your computer. To continue installing the program click the "Next >" button.

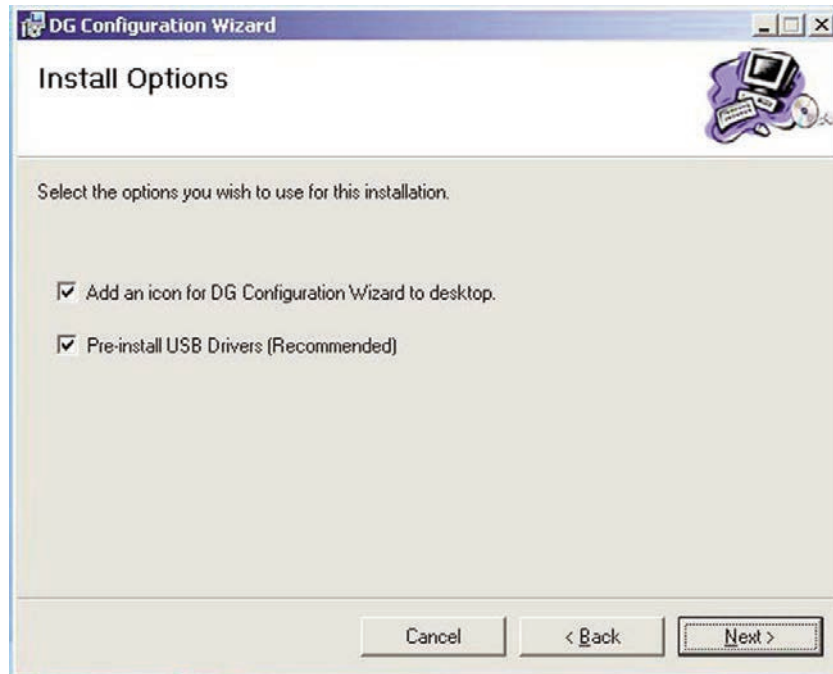

Figure 3-2. Software - Install Options Screen

From this screen you select if you want the program icons to be placed on your desktop and to automatically install the USB drivers. To continue with installing the program click the "Next >" button.

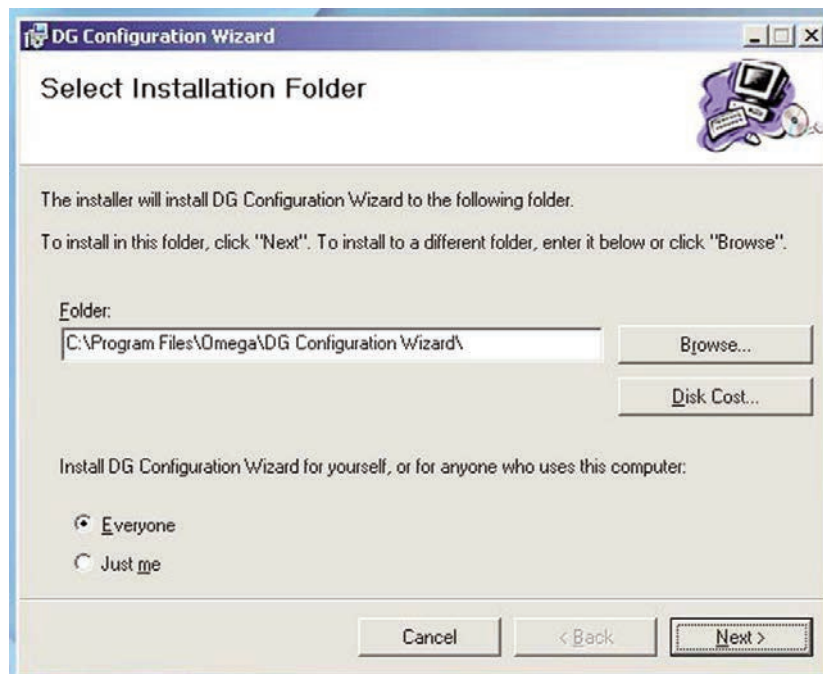

Figure 3-3. Select Installation Folder Screen

From this screen you select the folder where you want the program files installed on your PC. The default setting will install the software under your "Program" folders in a new folder named "Omega". To continue with installing the program click the "Next >" button.



Figure 3-4. Software - License Agreement Screen

From this screen you must select “Agree” to continue installing your program. After making your selection click the “Next >” button. The setup wizard will now complete the process and install the software.

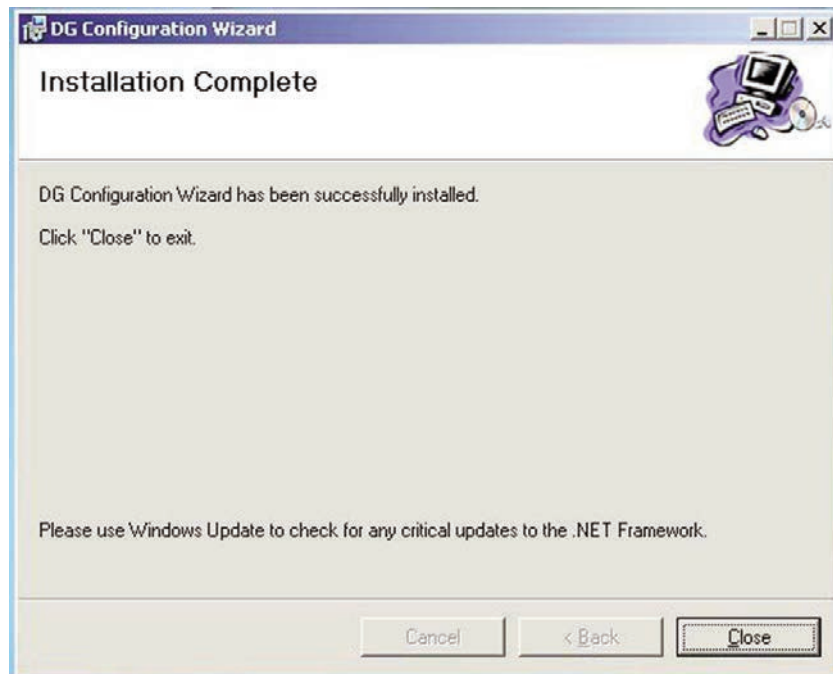

Figure 3-5. Software - Installation Complete Screen

Congratulations! You have just successfully installed the DG Setup Utility Program on your PC. To end installing the program and close the setup wizard click the “Close” Button

3.4 Configuration

Lid/ Cover Removal

To access the USB programming connector on your meter, the enclosure lid/ cover must be removed. Four screws must be removed. Be careful to not lose or discard these screws. These screws play a vital part in providing the water tight seal on your unit.

CAUTION:

The same four screws removed in this procedure must be re-installed into your meter housing or you will not have the proper water tight seal. Failure to install these screws correctly may result in damage to your unit when the meter is exposed to wet conditions.

NOTE:

When reinstalling enclosure screws they must be tightened to 20 oz in.

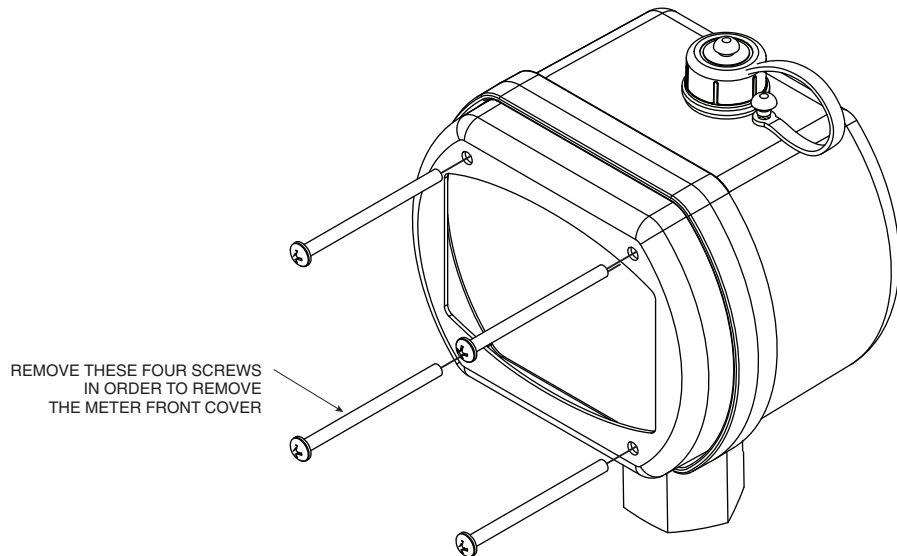

Figure 3-6. Lid/ Cover Removal

Connecting your meter to your computer

A USB Programming cable was included with your unit. This cable is only used during the setup and configuration of your meter. Note, this cable does not remain connected during normal use.

USB connector

USB programming cable location on your meter

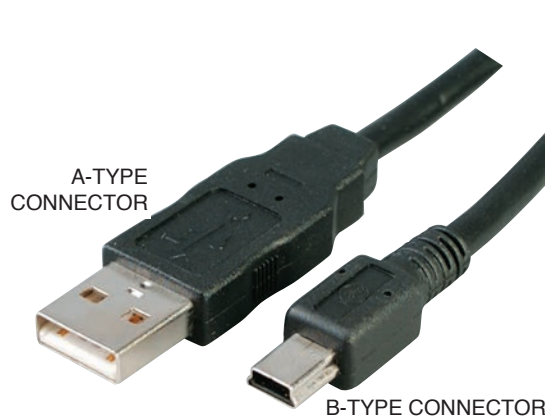

Figure 3-7. USB Programming Cable

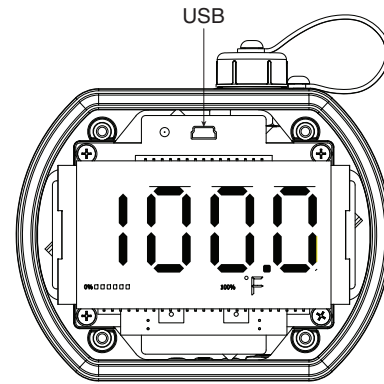

Figure 3-8. USB Connector Location

Connect the A-type connector to your PC and then connect the B-type connector to the USB port on your meter.

Setting Up Your Meter

Now that you have connected your USB cable to your PC and to your meter, you can now complete the following steps to configure your meter before placing the unit into operation. You will be using the configuration software utility that you installed onto your PC. If you have not installed the configuration software utility you should do so now.

STEP 1. Launch Setup Utility Program.

To launch the setup utility program on your PC begin by finding and clicking on the DTG program Icon that was placed on your computer desk top when you installed the software.

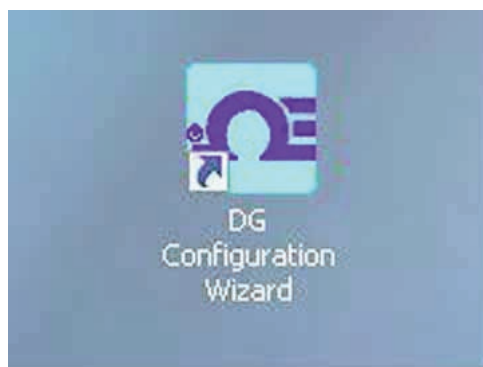

Figure 3-9. Launch Setup Utility Screen

STEP 2. Connecting & Communicating with your meter

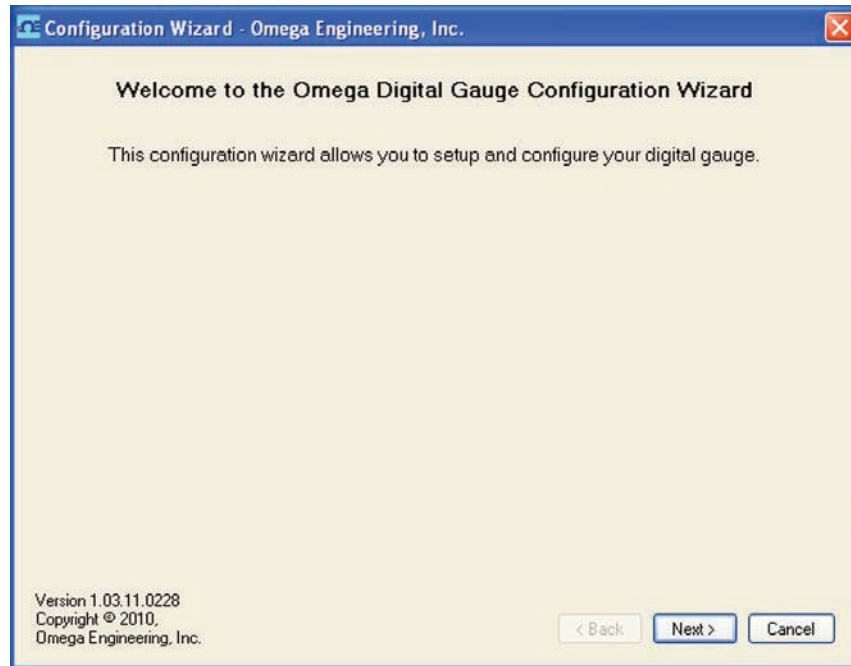

Figure 3-10. Utility Program - Welcome Screen

After starting the setup utility program this will be the first screen you will see. Click the "Next >" button to proceed and continue setting up your meter. Each screen will provide instruction details on how to proceed.



Figure 3-11. Utility Program - Connect To Digital Gauge Screen

If you have not already connected your meter to a USB port on your PC you must do this now before continuing. After your unit has been connected click the "Next >" button to proceed and continue setting up your unit.

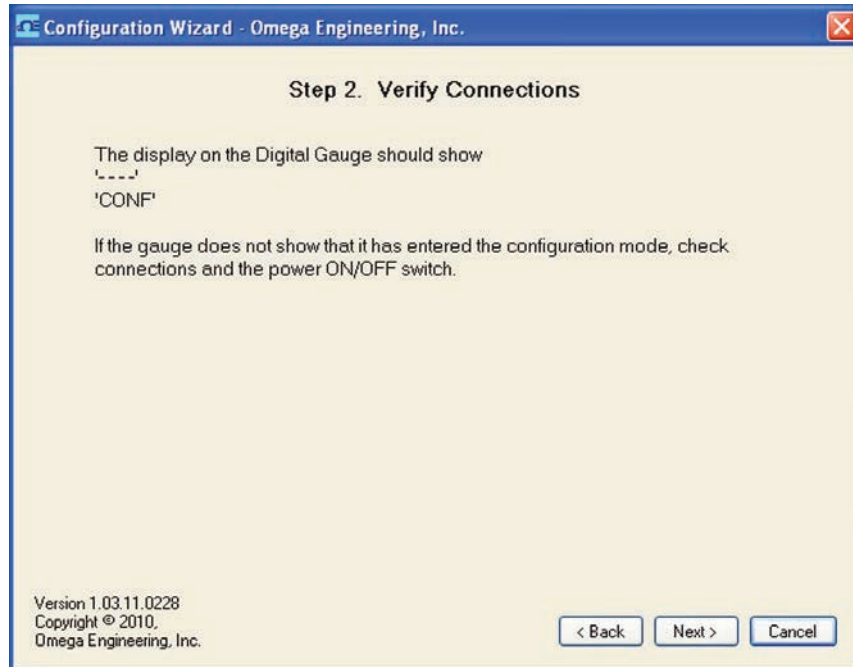

Figure 3-12. Utility Program - Verify Connections Screen

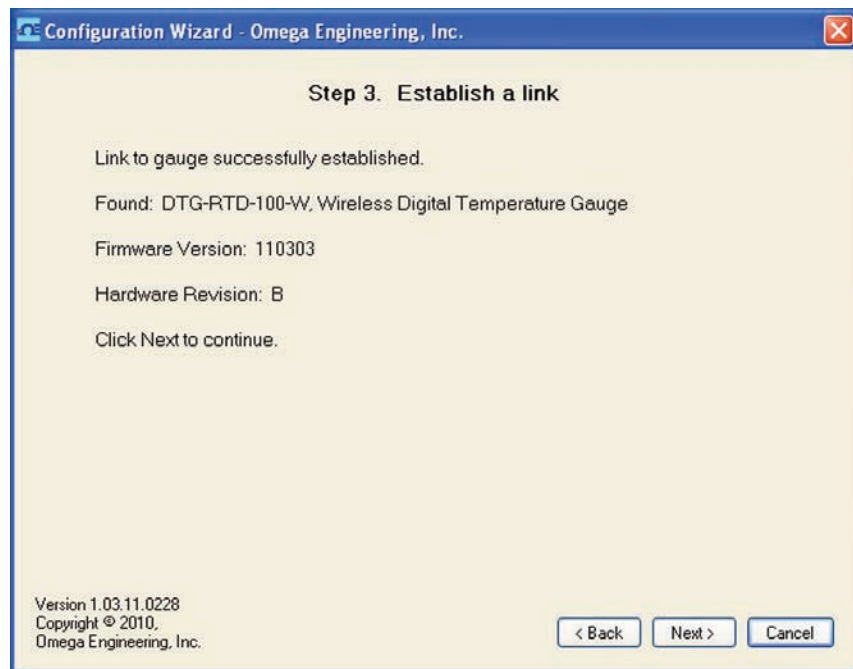

Figure 3-13. Utility Program - Establish Link Screen

After successful communication between your connector/transmitter has been established you can click the "Next >" button to proceed and continue setting up your connector/transmitter. If you did not receive this confirmation of proper communication you should click the "Back" button to try connecting again

Configuration Wizard - Omega Engineering, Inc.

Step 5. Choose Options

Choose backlight, sensor, wireless, analog output, and front panel options for this Wireless Digital Temperature Gauge. NOTE: Each end device must have a unique address or the system will malfunction. Addresses can be any number between 1 and 65533.

Backlight Options

Intensity: 25% 50% 75% 100%

External Power: Always Off 60 Seconds On 300 Seconds On Always On

Battery Power: Always Off 10 Seconds On 30 Seconds On

Sensor Options

Sample Interval (sec):
 With external power, interval is always 0.375
 RTD Alpha: 0.00385 0.00392

RF Network Settings

RF Channel: Network ID: Receiver Address:
 These settings must match corresponding settings of the UWTC-REC Receiver.
 Gauge Address: Transmit Interval (sec):
 Disable RF Transmission

Analog Output Options

Process Units:
 Scaling: 4 mA = °F
 20 mA = °F
 Mode: 4-20 mA 0-5 V 0-10 V
 Decimal Places:

Alarm Output

Alarm on: Setpoint:
 Low: °F
 Deadband: °F High: °F
 Decimal Places:

Front Panel/Display Options

Show Decimal Point Disable Keypad Disable Bargraph
 Display Alarm Mode: Off Normal Latching

Transfer Functions

$^{\circ}\text{F} = 6.3 \times \text{mA} - 25.0$
 $\text{mA} = 0.2 \times ^{\circ}\text{F} + 4.0$
 Format: Standard Scientific
 Decimal Places:

Calculator

mA = °F
 °F = mA

Version 1.03.11.0228
 Copyright © 2010,
 Omega Engineering, Inc.

Figure 3-14. Utility Program - Choose Options Screen

From this screen you will select the main operating settings for your end device. (Note: Each end device must have a different address number for proper operation). After making your selections click the “Next >” button to proceed and program your settings into your unit.

(1) Backlight Options

Intensity

Here you can set how bright you want the backlighting to be when on. Keep in mind that when used under battery power the led brightness has a direct effect on the life of the battery. Keep to the lowest setting possible for your ambient light conditions to conserve of battery power.

External Power

Here you can set the amount of time you want the backlighting to stay on when activated and the unit is running on external power. Note that you can only set the backlighting to be “Always On” when the unit is powered by an external power supply. When set to 60 or 300 seconds the backlight will come on and then turn off after the allotted time has expired.

Battery Power

Here you can set the amount of time you want the backlighting to stay on when activated and the unit is running on battery power only. Note that you can not set the backlighting to be “Always On” when the unit is powered by battery power. When set to 10 or 30 seconds the backlight will come on and then turn off after the allotted time has expired. If backlighting is not required it is recommended that you select “Always Off” to preserve battery life.

(1) Backlight Options

Intensity

Here you can set how bright you want the backlighting to be when on. Keep in mind that when used under battery power the led brightness has a direct effect on the life of the battery. Keep to the lowest setting possible for your ambient light conditions to conserve of battery power.

External Power

Here you can set the amount of time you want the backlighting to stay on when activated and the unit is running on external power. Note that you can only set the backlighting to be “Always On” when the unit is powered by an external power supply. When set to 60 or 300 seconds the backlight will come on and then turn off after the allotted time has expired.

Battery Power

Here you can set the amount of time you want the backlighting to stay on when activated and the unit is running on battery power only. Note that you can not set the backlighting to be “Always On” when the unit is powered by battery power. When set to 10 or 30 seconds the backlight will come on and then turn off after the allotted time has expired. If backlighting is not required it is recommended that you select “Always Off” to preserve battery life.

(2) Sensor Options

Sample Interval

Here you can set how often the device samples the sensor and updates the LCD.

NOTE:

The sample interval is always fixed at 0.382 seconds/sample (2.6 samples/second) when powered externally, regardless of the setting in the Configuration Wizard. The purpose of the sample interval setting is for conserving battery life, not for display damping or averaging, and therefore has no effect unless operating on battery power only.

RTD Alpha

Select the proper curve for the sensor or probe you will be measuring with your unit. Note, if you ordered a unit with an integral probe, this setting will be factory locked to match the probe installed.

(3) Front Panel Options

Show Decimal Point

Select this option to turn on or off the last digit and decimal point

Disable Keypad

Select this option to turn off the front keypad buttons. If selected during setup the buttons will be locked and will not be activated by the magnetic stylus.

Disable Bar Graph

Select this option to remove the bar graph indicator from the display.

(4) Alarm Output

Alarm On

Disabled - The alarm output is disabled and will not operate.

Rising - The alarm output activates ONLY when the temperature meets or exceeds the High Setpoint.

Falling - The alarm output activates ONLY when the temperature meets or falls below the Low Setpoint.

Rising & Falling - The alarm output activates when either the temperature meets or exceeds the High Setpoint OR the temperature falls below the Low Setpoint

HAL (High Alarm Limit) Setpoint

Set here the high value you want the alarm to activate at.

HAL (High Alarm Limit) Deadband

Deadband is an area where no action occurs. The purpose is to prevent oscillation or repeated activation-deactivation cycles. If your process value will always be very close to your alarm setting you should adjust the deadband to be a few degrees different than your alarm value.

LAL (Low Alarm Limit) Setpoint

Set here the low value you want the alarm to activate at

LAL (Low Alarm Limit) Deadband

Deadband is an area where no action occurs. The purpose is to prevent oscillation or repeated activation-deactivation cycles. If your process value will always be very close to your alarm setting you should adjust the deadband to be a few degrees different than your alarm value.

(5) Analog Output Options

Mode

Select the type of analog output your application requires. You can leave the default setting if you will not be using the analog output feature.

NOTE:

YOU MUST SET THE WIRE JUMPERS LOCATED ON THE BACK OF YOUR METER TO MATCH THE ANALOG OUTPUT TYPE YOU SELECTED HERE IN THE SETUP PROCESS.

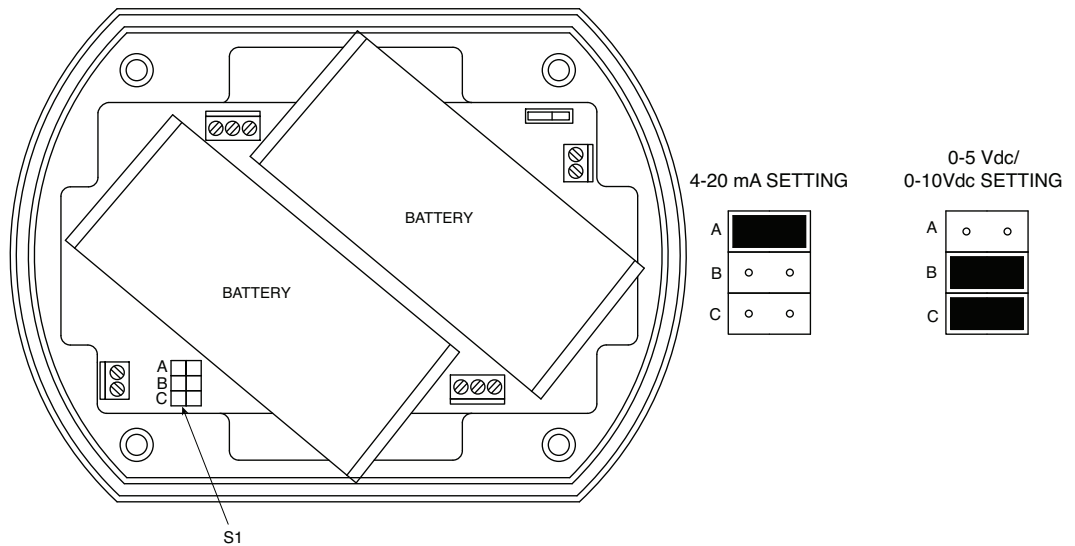

Figure 3-15. Analog Output Options

Scaling

Here you can scale the analog output to correspond to the process reading value.

4-20 mA Example:

This table shows analog output values you should expect if you set $4\text{mA} = 0^\circ\text{F}$ and $20\text{mA} = 1000^\circ\text{F}$

Process Reading	Analog Output Value
0°F	4.00 mA
250°F	8.00 mA
500°F	12.00 mA
750°F	16.00 mA
1000°F	20.00 mA

0-10 Vdc Example:

This table shows analog output values you should expect If you set $0.0\text{Vdc} = 0^\circ\text{F}$ and $10.0\text{Vdc} = 1000^\circ\text{F}$

Process Reading	Analog Output Value
0°F	0.00 Vdc
250°F	2.50 Vdc
500°F	5.00 Vdc
750°F	7.50 Vdc
1000°F	10.00 Vdc

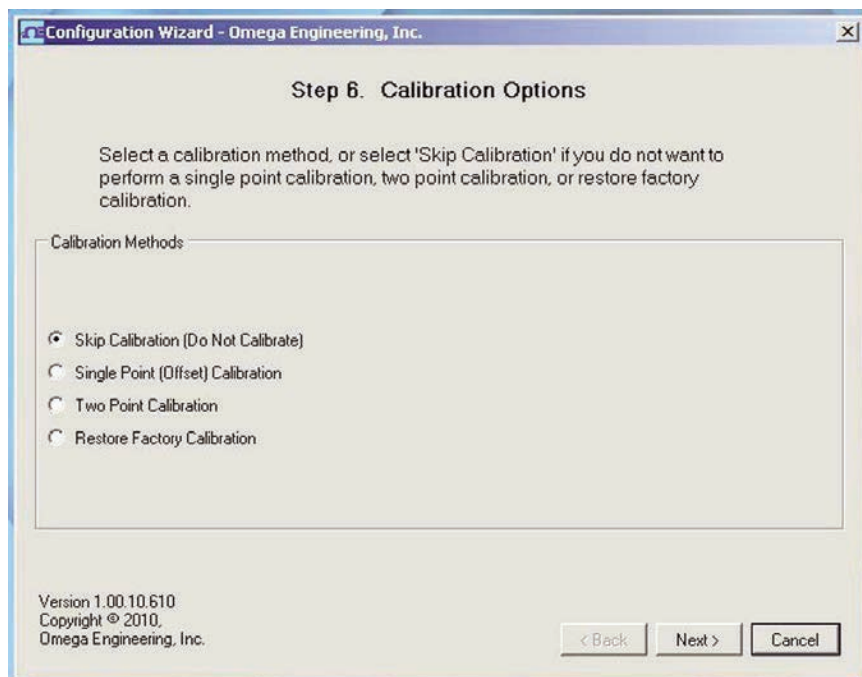

Figure 3-16. Calibration Options Screen - Skip Calibration Option

From this screen you will select a Calibration option. If the unit does not require calibration you should leave the default selected "Skip Calibration" and continue by clicking the "Next >"

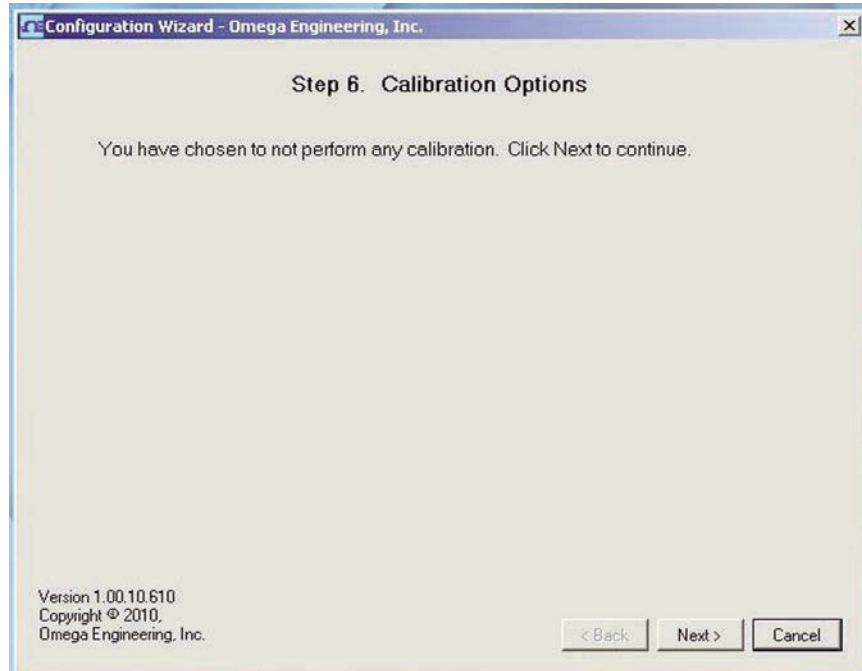

Figure 3-17. Calibration Options Screen - Skip To Next Option

After making your selections click the "Next >"

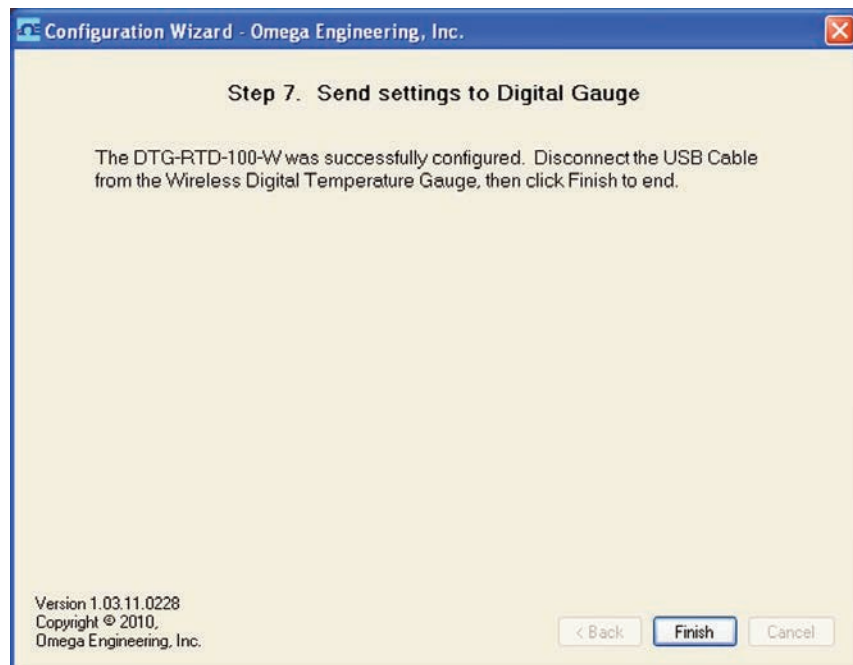

Figure 3-18. Send Settings To Digital Gauge Screen - Finish Option

After your meter has been programmed click the "Finish" button to close the utility program.

NOTES:

Section 4 – Installation, Mounting & Wiring

4.1 Installation

Model DTG-RTD100 is NEMA 4X rated (Water tight, dust tight, corrosion-resistance - indoor & outdoor use). The meter can be installed in locations where it will be intermittently exposed to spraying water, rain or high humidity. The meter should never be used under water.

WARNING

This meter is not designed for, tested, approved or certified for use in intrinsically safe applications or for applications where exposition proof instruments are required. Never operate in areas where flammable gases or material are present.

4.2 Ambient Temperature

Your meter should only be installed in locations that maintain an ambient temperature between -40 to 70°C (-40 to 158°F)

4.3 General Meter Dimensions

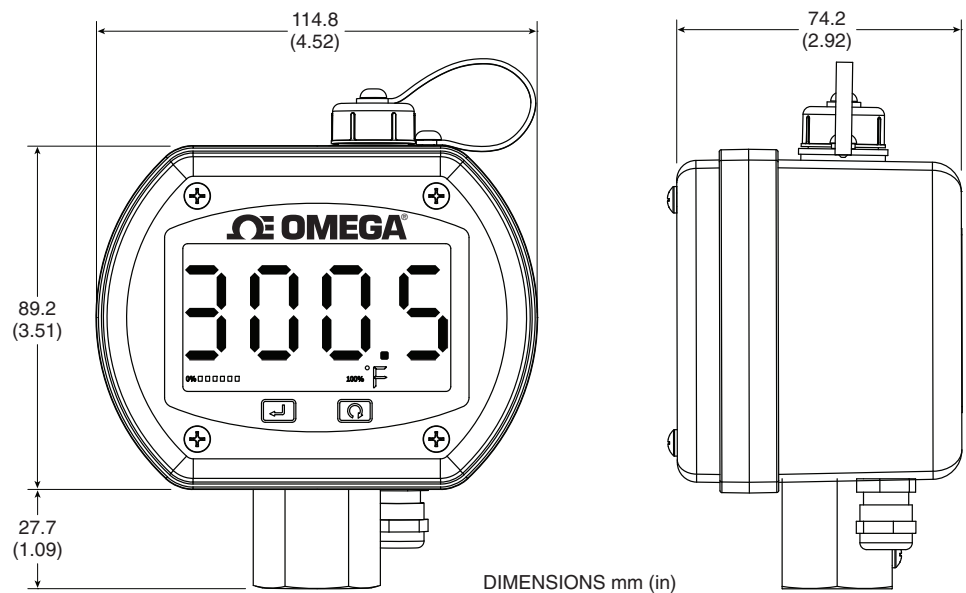

Figure 4-1. General Meter Dimensions

4.4 Battery Installation/Replacement

To install or replace the battery in your End Device you must first remove the four screws located on the Lid of the enclosure. This will allow you to remove the meter assembly and access the battery Holders.

NOTE:

Model DTG-RTD100 requires only one battery for normal operation (Battery1). A second battery (Battery 2) can be added to extend operation when on battery power. It is also recommended that thee additional battery (Battery 2) be installed for models that include the optional wireless transmitter.

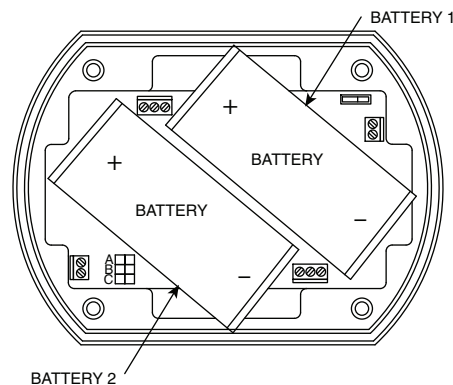

Figure 4-2. Battery Installation/ Replacement

Lithium batteries may get hot, explode or ignite and cause serious injury if exposed to abusive conditions. Be sure to follow the safety warnings listed below:

- Do not use a different battery other than what is specified in this manual or product data sheet.
- Do not discharge the battery using any device except your meter.
- Do not place the battery in fire or heat the battery.
- Do not store batteries with other hazardous or combustible materials.
- Do not install the battery backwards so the polarity is reversed.
- Do not connect the positive terminal and negative terminal of the battery to each other with any metal object (such as wire).
- Do not carry or store the battery together with metal objects.
- Do not pierce the battery with nails, strike the battery with a hammer, step on the battery or otherwise subject it to strong impacts or shocks.
- Do not solder directly onto the battery.
- Do not expose battery to water or salt water, or allow the battery to get wet.
- Do not disassemble or modify the battery.

- Immediately discontinue use of the battery if the battery emits an unusual smell, feels hot, changes color or shape, leaks or appears abnormal in any other way.
- Do not place the battery in microwave ovens or high-pressure containers.

4.5 Mounting

The DTG-RTD100 can be mounted in one of two different ways depending upon if you are using an external RTD sensor or if you ordered a model with the integral probe assembly.

Models Without Integral Probe

A mounting bracket accessory is available, model number: DTG-RTD100-MB. The mounting bracket attaches to the DTG-RTD100 meter and allows for wall mounting.

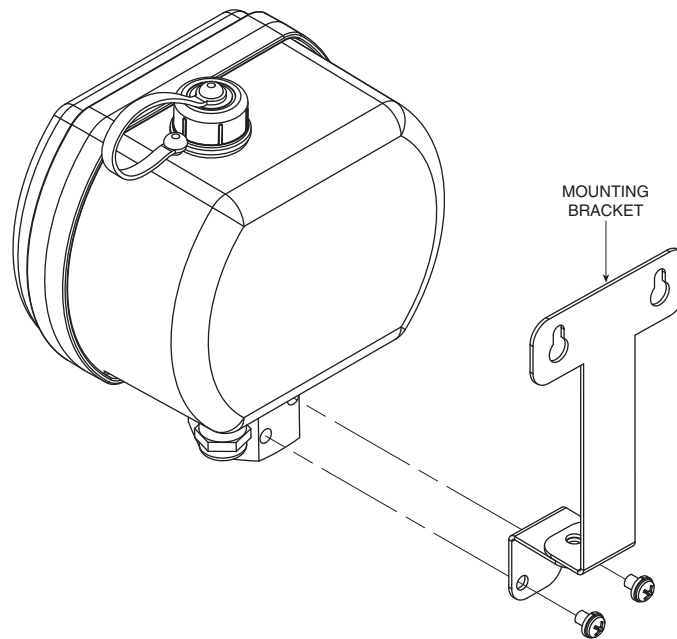

Figure 4-3. Mounting Bracket Accessory
Model: DTG-RTD100-MB

Models With Integral Probe

Models with an integral probe are designed to be installed into a threaded thermowell housing. This allows the meter to be self supported and does not require a mounting bracket.

4.6 Wiring (Sensor, Power, Analog Output)

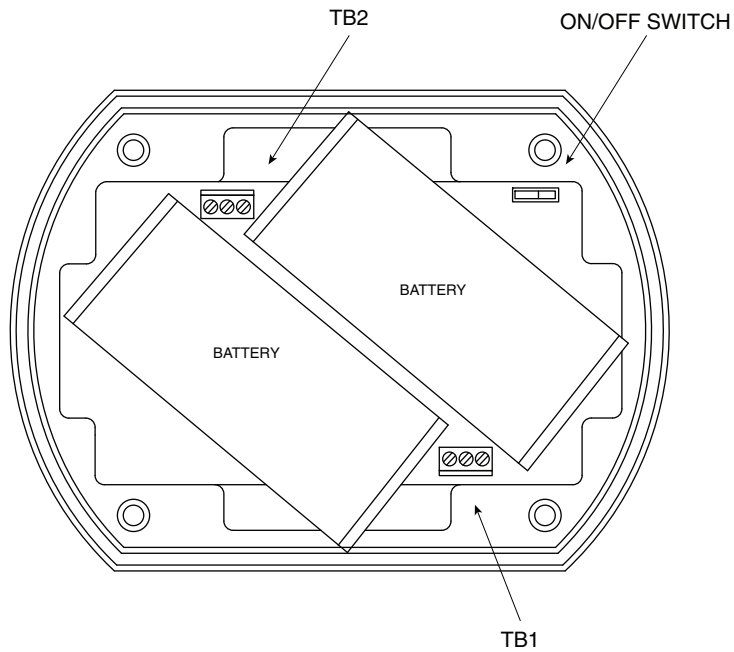

Figure 4-4. Wiring - Terminal Block Location

Temperature Sensor Wiring

Model DTG-RTD100 is designed to operate with a 3-wire, PT100 external sensor or integral probe assembly. Wires are connected to TB1 located on the rear circuit board between the battery holder.

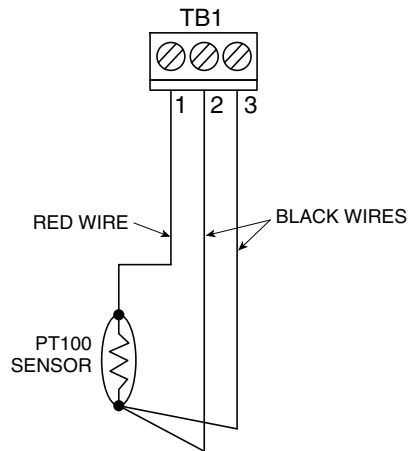

Figure 4-5. Wiring - Temperature Sensor

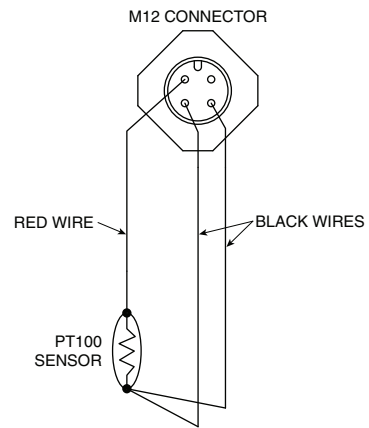

Figure 4-6. Wiring - M12 Connector

Power Supply Wiring Example

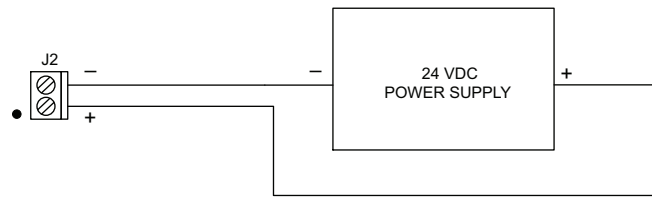

Figure 4-7. Wiring - Power Supply

Analog Output Wiring Example

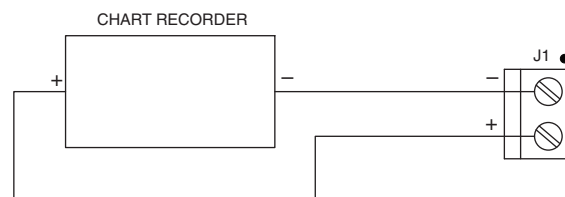

Figure 4-8. Wiring - Analog Output

Alarm Wiring Example

Driving a relay or low impedance input (Open Drain)

NOTE:

Diode required for magnetic relays. Not required for solid state relays or magnetic relays with internal diode.

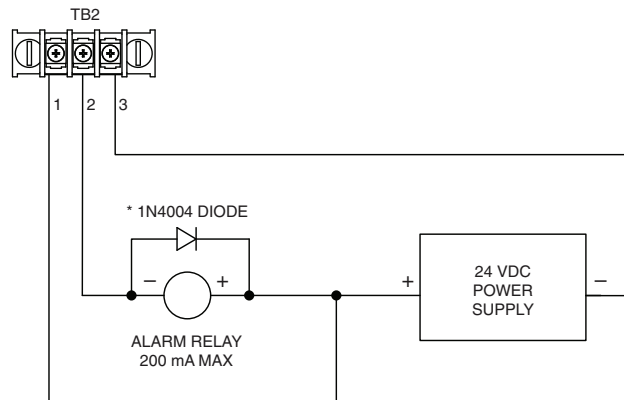

Figure 4-9. Wiring - Alarm

Section 5 – Display Features & Meter Operation

5.1 Display Features

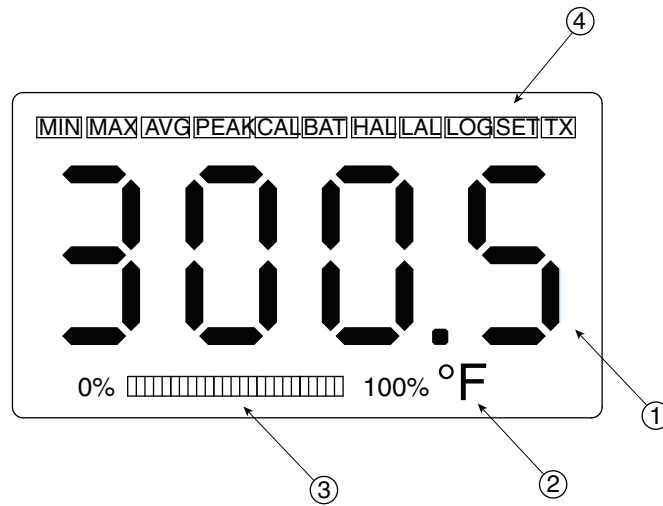

Figure 5-1. Display Features

(1) Process Reading, (2) Units, (3) Bargraph, (4) Status Icons

5.2 Keypad Operation

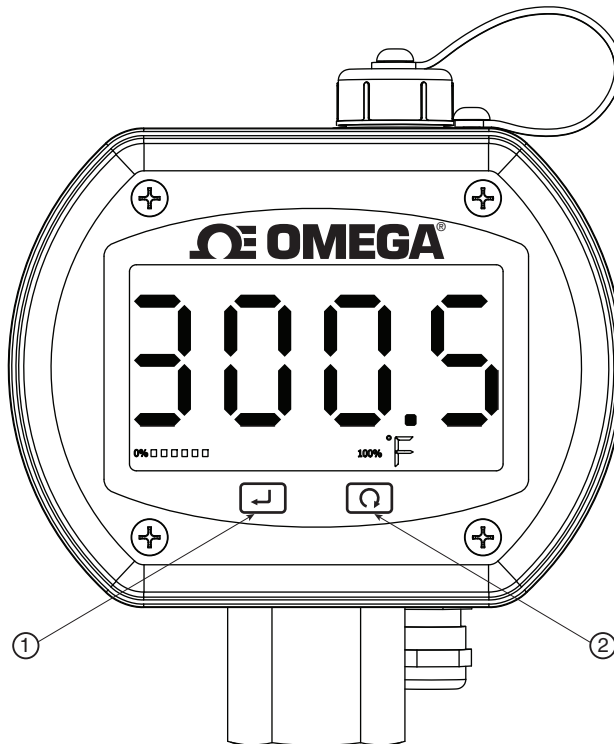

Figure 5-2. Keypad Operations

(1) Mode Button, (2) Set Button

Magnetic Stylus

A magnetic stylus is attached to your meter. This stylus is used to activate the front buttons on the display. If you do not need to view the “MIN”, “MAX” or “AVERAGE” readings during normal operation, or have a need to turn the backlight on during normal operation you can remove and store this stylus. You will need to select “Disable Keypad” during the setup and configuration process.



Figure 5-3. Magnetic Stylus

Button Operation

The “MODE” and “SET” buttons located on the front display of your meter are activated by waving or taping the magnetic stylus included with your unit above or onto the keypad button symbol on the front meter label.

Mode Button Operation – To activate the “MODE” button, place the tip of the magnetic stylus over the “MODE” button and hold for three seconds until the unit enters the “MODE” menu. Then move away the magnetic stylus. Each time the magnetic stylus is again placed near the “MODE” button the meter will step through each parameter.

“SET” Button Operation - The “SET” button has two primary functions. Independently the button is used to turn the backlighting on. To activate the backlight, place the tip of the magnetic stylus over the “SET” button and hold for three seconds until the backlighting turns on. The backlighting will remain on for the amount of time you selected during the setup and configuration process.

NOTE:

If you selected “Always Off” when setting the meter up, then the “SET” button will not turn the backlighting on from the front keypad.

When in the “MODE” menu, the “SET” button is used for the following:

1. To reset the MIN, MAX, or AVG values to the current temperature reading. All three are reset simultaneously, from any one of the three screens, MIN, MAX, or AVG.
2. To silence the High or Low alarm, when in the “HAL” or “LAL” screen and the alarm is configured for “Latching”. This will cause the display to stop blinking, however, the alarm output will remain activated until the alarm condition clears.
3. To turn the wireless transmitter “On” or “Off” while in the “WRLS” screen.
4. To select units of measure while in the “UNIT” screen.

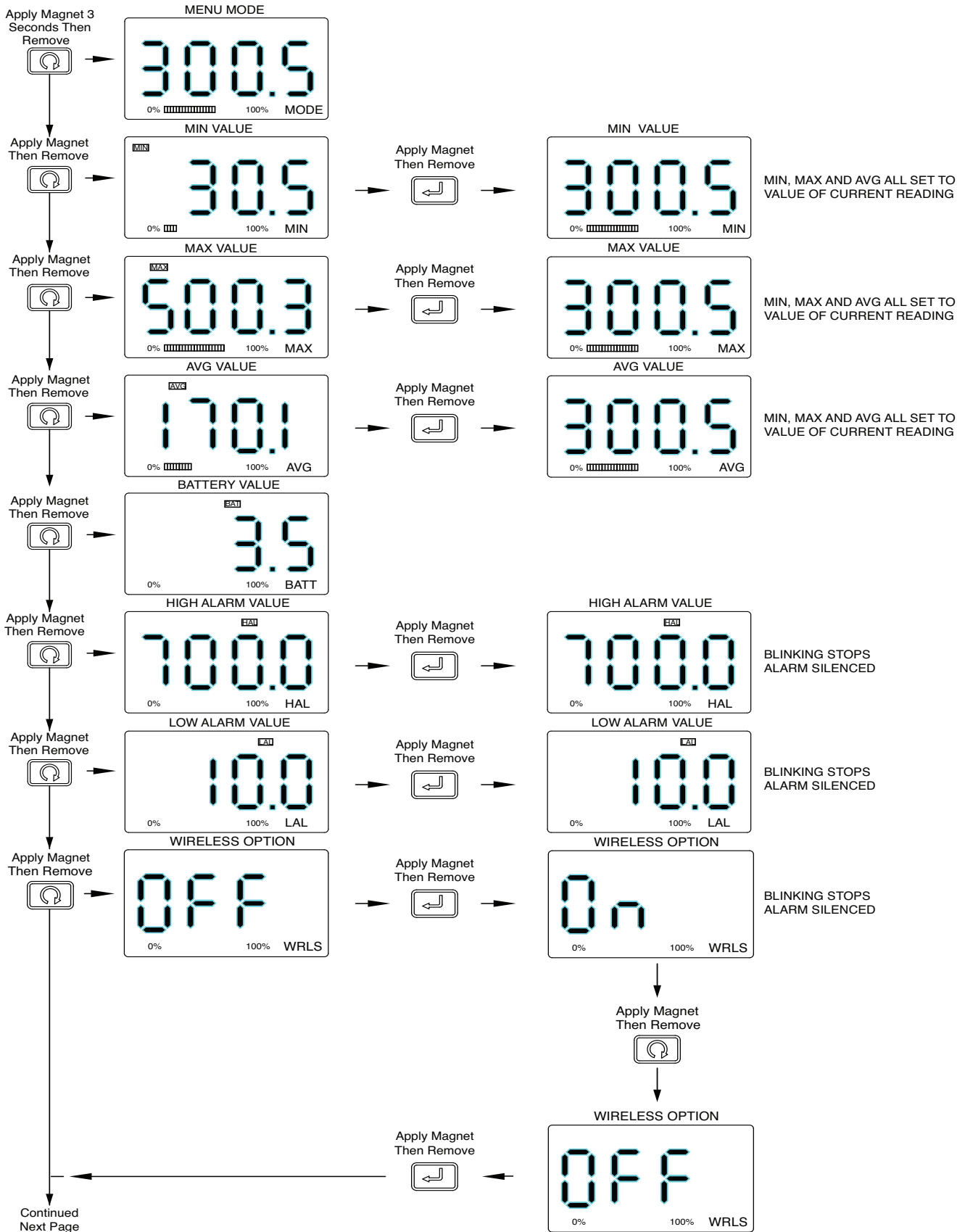

Figure 5-4. Menu Button Operation

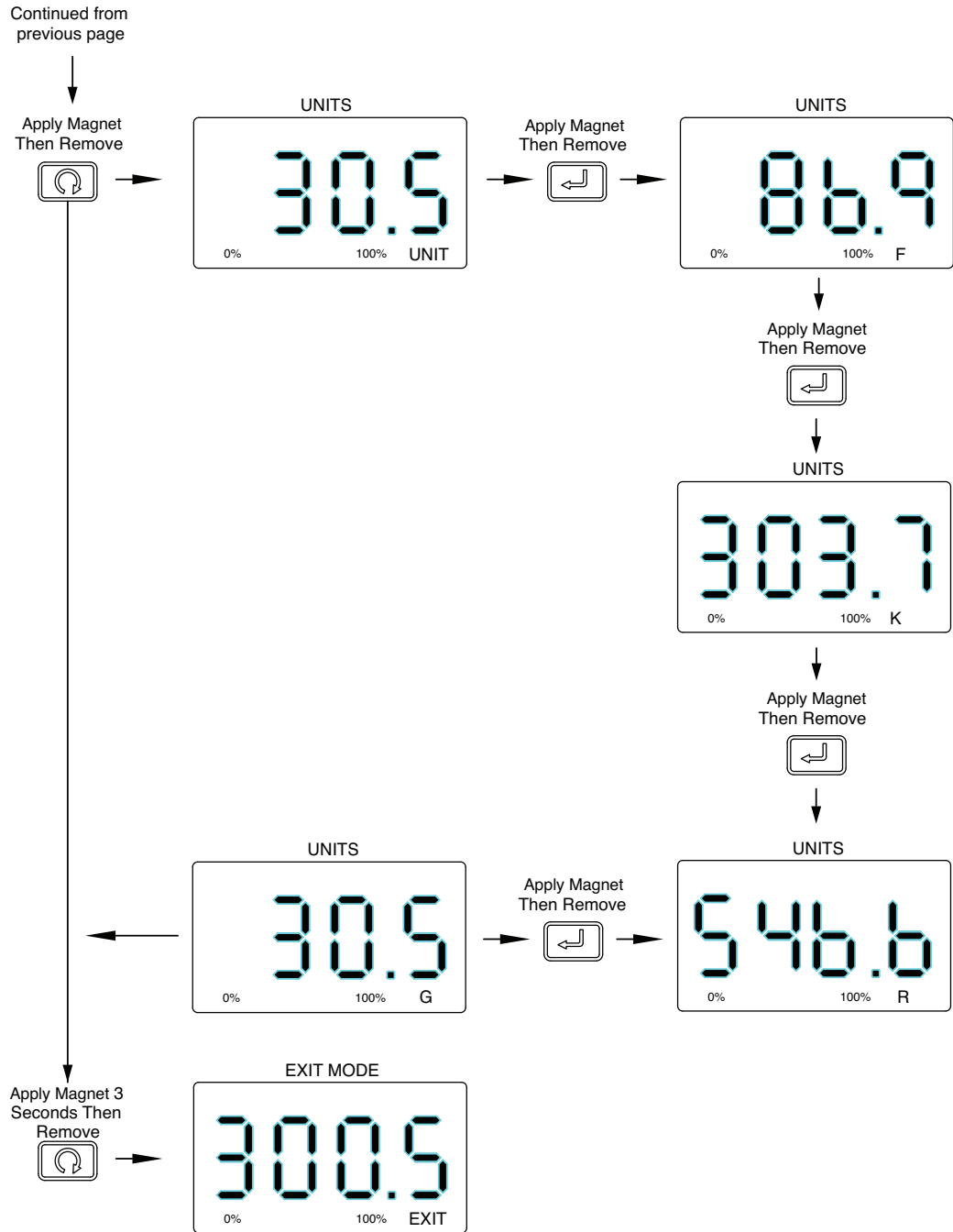

Figure 5-4. Menu Button Operation Continued

Backlighting Operation

The front keypad “Set” Button can be used to activate the backlighting feature. When activated, the backlighting will remain on for the period of time you selected during the setup and configuration in Section 3.

Apply Magnet 3
Seconds To Activate
Backlight

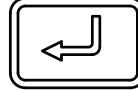

Figure 5-5. Front Keypad Set Button

Section 6 – Optional Wireless Transmitter Operation

6.1 Introduction

Compared to a wired connection, a wireless meter provides much simpler installation. Based on the physical principle of the propagation of radio waves, certain basic conditions should be observed. The following simple recommendations are provided to insure proper installation and correct operation of your wireless meter.

6.2 RF Communication Basics

Your wireless transmitter sends wireless transmissions to a receiver. The receiver checks the incoming data for accuracy and processes this data for use by the measurement software on your PC. Radio signals are electromagnetic waves, hence the signal becomes weaker the further it travels. While radio waves can penetrate some solid materials like a wall, they are dampened more than when a direct line-of-sight between the transmitting and receiving antenna exist.

6.3 Basic System Overview

A basic wireless temperature system is comprised of only two main components; a signal conditioner with a built-in battery powered 2.4GHz radio transmitter, and a USB powered 2.4GHz radio receiver.

Installation

When installing your meter it is important to position the unit in such a way as to optimize the antenna location within what's known as the "Fresnel Zone".

The Fresnel Zone can be thought of as a football-shaped invisible tunnel between two locations that provides a path for RF signals between your meter and your receiver.

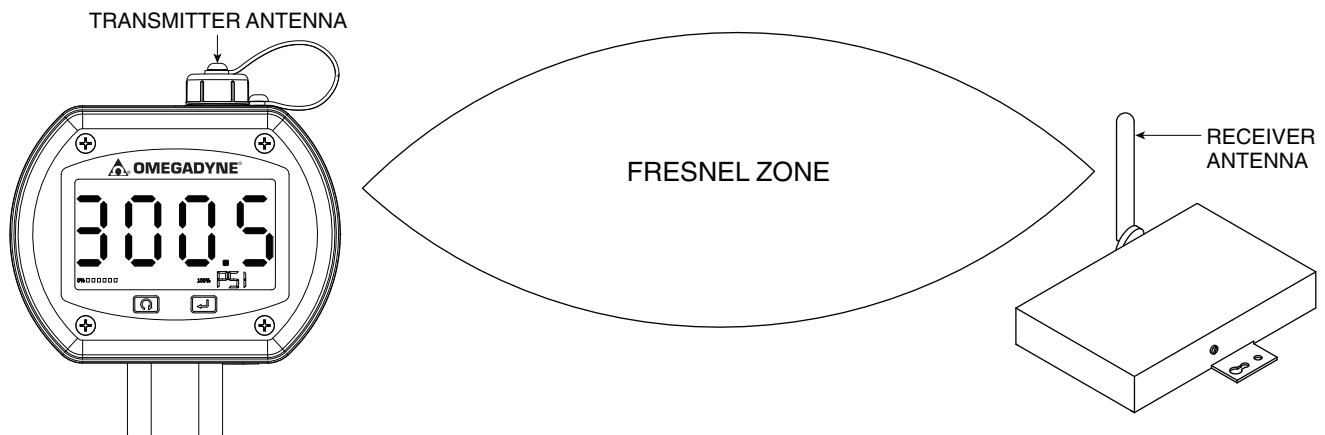

Figure 6-1. Fresnel Zone

In order to achieve maximum range, the football-shaped path in which radio waves travel must be free of all obstructions. Obstacles in the path (especially metal) will decrease the communication range between your meter and receiver. Also, If the antennas are mounted just barely off the ground, over half of the Fresnel zone ends up being obstructed by the earth resulting in significant reduction in range. To avoid this problem, the antennas should be mounted high enough off of the ground so that the earth does not interfere with the central diameter of the Fresnel zone.

NOTE:

It is important to understand that the environment may change over time due to new equipment or machinery being installed, building construction, etc. If new obstacles exist between your meter and receiver, the devices can be raised on one end or on both ends to clear the Fresnel Zone of obstructions.

CAUTION:

Installing your meter in an application where the unit will be exposed to ambient temperatures above or below the operating limits specified in this manual will damage your unit and cause the unit to malfunction and produce incorrect operation.

NOTE:

Your meter has been shipped to you with a standard approved antenna. Use of any other antenna than what's supplied with your meter will void all FCC, IC and CE regulatory compliance.

Environment

Omega's wireless end devices and receiver units have been designed to be fixed mounted and operated in a clean and dry indoor environment. Care should be taken to prevent the components of your wireless system from being exposed to moisture, toxic chemicals and extreme cold or hot temperature that are outside the specifications listed in this manual.

The following is a list of basic good practice you should apply when operating your wireless system.

- Never operate your wireless device or receiver outside the recommended environmental limits specified in this manual.
- Never operate your wireless end device or receiver in flammable or explosive environments.

- Never use your wireless end device or receiver in medical, nuclear or other dangerous applications where an interruption of readings can cause damage or harm.
- Never operate your end device or receiver with any other battery or power source than what's specified in this manual or on the battery compartment label.
- No co-location with other radio transmitters is allowed. By definition, co-location is when another radio device or it's antenna is located within 20 cm of your end device and can transmit simultaneously with your end device.
- Never install end devices within 20 cm or less from each other.
- Never use your end device as a portable device. Your unit has been designed to be operated in a permanent installation.
- Never install and/or operate your end device closer than 20 cm to nearby persons.
- Never operate your end device with any other antenna than what is supplied or listed here in this manual for approved use.

6.4 Transmit Rate vs. Battery Life

Many factors such as ambient temperature conditions and transmitting rate can have a big effect on the life of the battery used in your meter. Transmitting data places a big demand of the battery in your unit. The transmit rate is the single most contributing factor in the life of the battery. The slower the transmit rate you set, the longer the battery in your device will last. The tables and graphs below give some estimates on how long the battery should last vs. the transmit rate you selected when you setup your meter under normal operating conditions.

6.4.1 DTG-RTD100 Battery Life – Standard Model

Table 1: DTG-RTD100 - Standard Model - Battery Life

DTG-RTD100 Estimated Battery Life				
Batteries:	4.8Ah x 1	4.8Ah x 2	8.5Ah x 1	8.5Ah x 2
Seconds per Sample:	Weeks	Weeks	Weeks	Weeks
0.38	21.6	43.1	38.2	76.3
0.5	26.2	52.4	46.4	92.7
1	38.6	77.1	68.3	136.6
2	50.5	101.1	89.5	179.0
3	56.4	112.7	99.8	199.6
4	59.8	119.6	105.9	211.8
5	62.1	124.2	110.0	219.9
10	67.2	134.4	119.0	238.1
15	69.1	138.2	122.4	244.8
30	71.1	142.3	126.0	251.9

6.4.2 DTG-RTD100-W Battery Life – Wireless Model

For the DTG-RTD100-W digital RTD meter, the battery life of the device is controlled by three variables – the battery capacity, the analog output rate, and the wireless transmission rate. The battery capacity can either be 9600 mA hours (using 2 of the 4.8Ah capacity batteries), or 17,000 mA hours (using 2 of the 8.5Ah capacity batteries). Below are two tables showing the battery life estimates in both scenarios, at various analog output rates.

**Table 2: DTG-RTD100-W - Wireless Model – Battery Life
(2 x 4.8Ah Batteries)**

DTG-RTD100-W Estimated Battery Life				
(2 x 4.8Ah Batteries: 9600 mA Hours)				
Analog Seconds/ Sample:	.5	5	15	30
Seconds per Wireless Transmission:	Weeks	Weeks	Weeks	Weeks
2	31.8	48.8	50.9	51.4
3	36.6	61.2	64.4	65.3
5	41.6	76.8	81.9	83.3
10	46.5	94.9	102.9	105.1
15	48.3	103.1	112.5	115.1
30	50.3	112.7	124.1	127.3
45	51.0	116.3	128.5	131.9
60	51.4	118.2	130.8	134.4
120	52	121.2	134.4	138.2
RF OFF	52.5	124.3	138.3	142.3

**Table 3: DTG-RTD100-W - Wireless Model – Battery Life
(2 x 8.5Ah Batteries)**

DTG-RTD100-W Estimated Battery Life

(2 x 8.5Ah Batteries: 17,000 mA Hours)

Analog Seconds/ Sample:	.5	5	15	30
Seconds per Wireless Transmission:	Weeks	Weeks	Weeks	Weeks
2	56.3	86.5	90.1	91.0
3	64.8	108.4	114.1	115.6
5	73.7	136.0	145.1	147.6
10	82.3	168.1	182.2	186.1
15	85.6	182.5	199.2	203.9
30	89.1	199.5	219.7	225.4
45	90.4	205.9	227.5	233.6
60	91.0	209.3	231.6	237.9
120	92.0	214.5	238.0	244.7
RF OFF	93.0	220.1	244.9	251.9

6.5 Wireless Transmitter Setup

After connecting the USB cable and running the configuration software as outlined in Section 3, you will complete the following steps to configure your wireless transmitter before placing the unit into operation. You will be using the configuration software utility that you installed onto your PC in Section 3. If you have not installed the configuration software utility you should do so now.

During this procedure you will be setting the following parameters in your transmitter.

RF Channel

This setting determines the operating channel on which RF connections are made between the transmitter and receiver. The transmitter must be set to the same channel as the receiver in order for them to communicate.

Network ID

This sets the ID of the Network that the transmitter will be joining. It must match the setting of the receiver in order for them to communicate.

Receiver Address

This sets a unique address number for your receiver. Later, when you set up your receiver you will again set the same number to receive readings from the corresponding transmitter unit(s). Each receiver must be set for a different number for your system to operate correctly.

**NOTE:**

If you will be using more than one receiver unit in your area it is important to set the transmitter address numbers to be a corresponding number in your TC-Central software. See Examples below.

For the first receiver:

Set the address on your transmitters to 101, 102, 103, 104, etc. Then set the address in your TC-Central software to match.

For the second receiver:

Set the channels on your transmitters to 201, 202, 203, 204, etc. Then set the address in your TC-Central software to match.

This numbering scheme can be expanded to match the number of receivers you are using.

Gauge Address

This sets a unique address number into your transmitter. Later, when you set up your measurement software you will use this address setting to receive readings from the corresponding unit(s). Each transmitter must be set for a different address for your system to operate correctly.

Wireless Transmission Rate

This will program your device to transmit 1 data reading to your receiver at a specified time interval. Available settings are 2, 3, 4, 5, 10, 15, 20, 25, 30, 45, 60, 75, 90, 105 or 120 seconds.

Section 7 - DTG-RTD100 Design for CE Conformity

All models of the DTG-RTD100 Digital RTD Meter have been designed to meet requirements as outlined in European Community EMC Directive EN50081-1/EN50082-1. Two ferrite cores and an output grounding cable are included in your DTG-RTD100 package; you must install the cable and both ferrite cores in order to meet radiated immunity specifications.

7.1 DTG-RTD100 Analog Output Grounding

The analog output cable is supplied with accompanying grounding hardware. The figures below specify the wiring and procedure required to properly ground your DTG-RTD100 unit.

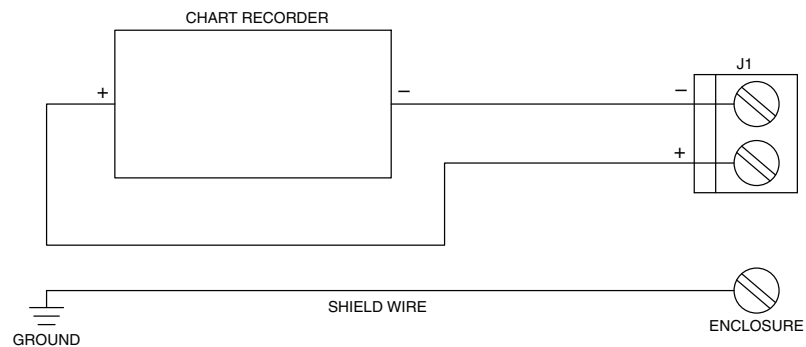

Figure 7-1. Analog Output Wiring Example

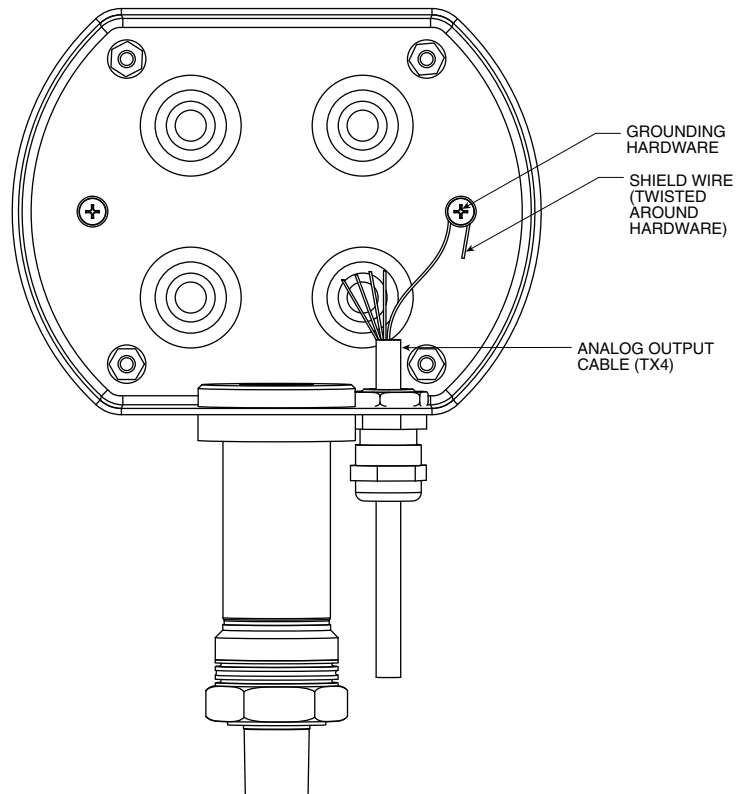

Figure 7-2. Analog Output Grounding Example

7.2 Ferrite Core

All models of the DTG-RTD100 Digital RTD Meter have been designed to meet requirements as outlined in European Community EMC Directive EN50081-1/EN50082-1. Two ferrite cores and an output grounding cable are included in your DTG-RTD100 package; you must install the cable and both ferrite cores in order to meet radiated immunity specifications.

To install the grounding output cable for your meter, refer to Section 4, Figure 4-8.

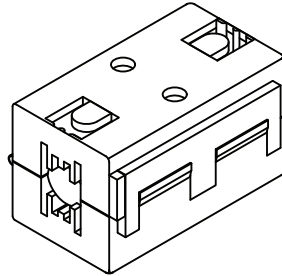

Figure 7-3. Ferrite Core

In order to conform to CE standards, the ferrite cores must be attached to the grounding output cable of the DTG-RTD100 as shown in Figure 7-4.

NOTE:

The ferrite cores **MUST** be secured on opposite ends of the output cable.

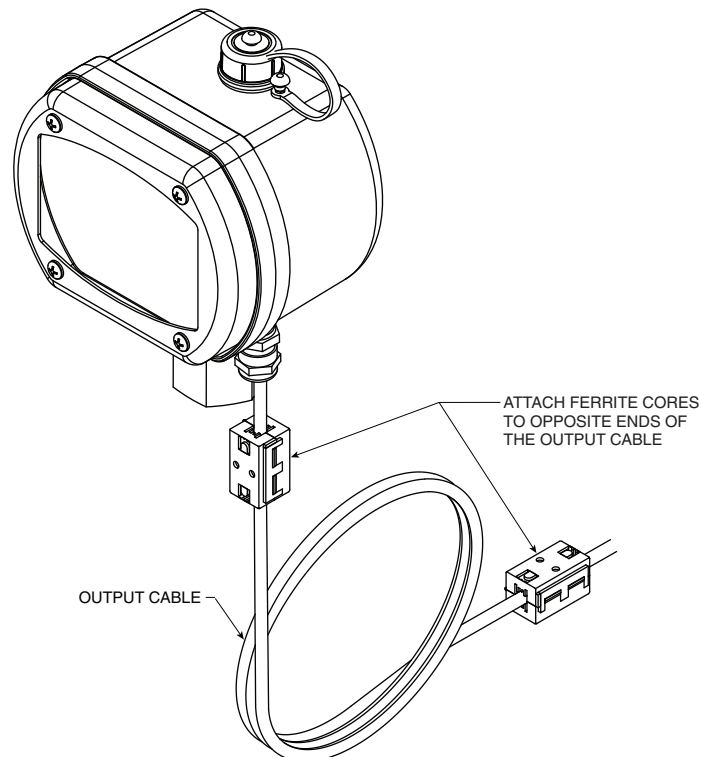

Figure 7-4. Ferrite Core Installation

Section 8 – Service & Calibration

Your DTG-RTD100 Thermometer has been built, tested and factory calibrated to meet or exceed the specifications listed here in this manual. Information is provided below on how to have your unit returned for service.

If your meter requires service or factory re-calibration, please call our Customer Service Department at 1-800-622-2378 or 203-359-1660. They will assist you in arranging the return of your meter. We can also be reached on the Internet at www.omega.com, e-mail: cservice@omega.com

Section 9 – Specifications

9.1 General

Range:	-51 to 538°C (-60 to 1000°F)
Accuracy:	±0.2°C (±0.3°F) or ±0.1% of reading, Whatever greater
Resolution:	0.1°C (0.1°F)
Operating Environment:	-40 to 70°C (-40 to 158°F); 5 to 100% RH non-condensing
RTD Probe/ Sensor Input:	Pt100, 3-wire
Display Type:	LCD with selectable backlight
Display Digits:	4 digits, 9999 counts
Character Height:	25.4 mm (1.0 in)
Computer Interface:	USB (one programming cable included)
Sample/ Display Rate:	1/second default, user adjustable from 1/0.375 sec. to 1/30 sec.
Battery Power:	One or Two 3.6V lithium, 8.4 Ah capacity (C-cell) one included
External Power:	12 to 24 Vdc (required for analog output operation)
Battery Life (Typical):	See section 6.4
Analog Output:	User selectable 0 to 5 Vdc, 0 to 10 Vdc, or 4 to 20 mA; Requires external 12 to 24 Vdc power supply for operation
Enclosure:	316 Stainless Steel housing, ABS center gasket
Enclosure Finish:	Electropolished
Enclosure Rating:	Weatherproof, NEMA 4 (IP65)
Enclosure Screw Torque:	20 oz in.
Dimensions:	4.53" H*, 4.52" W, 2.92" D (*height not including sensor)
Weight:	1.59 lbs.
Settings (USB/ Software)	
Units:	°C, °F, °K, °R
Lock:	Allows for front button lock-out
Alarms:	User selectable high and low alarm limits
Backlight:	On/off, or 10 sec, 30 sec, 1 min, 5 min
Backlight Color:	Normal Operation – Green, Low Alarm – Blue, High Alarm - Red

9.2 Wireless Option

Transmit Sample Rate:	User programmable from 1 sample/2 min to 1 sample/every 2 sec
Radio Frequency (RF) Transceiver Carrier:	ISM 2.4 GHz
RF Output Power:	10 dBm (10 mW)
Range of RF Link:	
Outdoor Line of Sight:	Up to 120 m (400 ft)
Indoor/ Urban:	Up to 40 m (130 ft)
Software (Included Free):	Requires Windows® 2000, XP or Vista (32 bit)
Data Transmitted to Host:	Temperature reading, ambient temperature reading, RF transmit strength and battery level

Section 10 – Approvals, Regulatory Compliance

NOTE:

All approvals outlined in this manual are based on testing that was done with antennas that are supplied with your meter. Removing and or installing a different antenna will void the product compliance demonstrated in these documents.

10.1 FCC (Domestic Use)

For United States: FCC ID: OUR-XBEEPRO

For Canada: IC #4214A-XBEEPRO

This device complies with Part 15 of the FCC rules. Operation is subject to the following two conditions: 1.) This device may not cause harmful interference. 2.) This device must accept any interference received, including interference that may cause undesired operation.

WARNING:

To satisfy FCC RF exposure requirements for mobile transmitting devices, a separation distance of 20 cm or more should be maintained between the antenna of this device and persons during device operation. To ensure compliance, operations at closer than this distance is not recommended. The antenna used for this transmitter must not be co-located in conjunction with any other antenna or transmitter.

10.2 International Usage & CE Marking

NOTE:

It is your (the user's) responsibility to insure that these products are operated within the guidelines here in this manual and in conformance with all local, state, federal or national regulations and laws of the country they are being operated in.

NOTE:

Transmitting Power - Your Wireless Series System Components have been designed, manufactured and tested so that the transmitting power of your wireless meter will not exceed 10 dBm.



WARRANTY/DISCLAIMER

OMEGA ENGINEERING, INC. warrants this unit to be free of defects in materials and workmanship for a period of **13 months** from date of purchase. OMEGA's WARRANTY adds an additional one (1) month grace period to the normal **one (1) year product warranty** to cover handling and shipping time. This ensures that OMEGA's customers receive maximum coverage on each product.

If the unit malfunctions, it must be returned to the factory for evaluation. OMEGA's Customer Service Department will issue an Authorized Return (AR) number immediately upon phone or written request. Upon examination by OMEGA, if the unit is found to be defective, it will be repaired or replaced at no charge. OMEGA's WARRANTY does not apply to defects resulting from any action of the purchaser, including but not limited to mishandling, improper interfacing, operation outside of design limits, improper repair, or unauthorized modification. This WARRANTY is VOID if the unit shows evidence of having been tampered with or shows evidence of having been damaged as a result of excessive corrosion; or current, heat, moisture or vibration; improper specification; misapplication; misuse or other operating conditions outside of OMEGA's control. Components in which wear is not warranted, include but are not limited to contact points, fuses, and triacs.

OMEGA is pleased to offer suggestions on the use of its various products. However, OMEGA neither assumes responsibility for any omissions or errors nor assumes liability for any damages that result from the use of its products in accordance with information provided by OMEGA, either verbal or written. OMEGA warrants only that the parts manufactured by the company will be as specified and free of defects. OMEGA MAKES NO OTHER WARRANTIES OR REPRESENTATIONS OF ANY KIND WHATSOEVER, EXPRESSED OR IMPLIED, EXCEPT THAT OF TITLE, AND ALL IMPLIED WARRANTIES INCLUDING ANY WARRANTY OF MERCHANTABILITY AND FITNESS FOR A PARTICULAR PURPOSE ARE HEREBY DISCLAIMED. LIMITATION OF LIABILITY: The remedies of purchaser set forth herein are exclusive, and the total liability of OMEGA with respect to this order, whether based on contract, warranty, negligence, indemnification, strict liability or otherwise, shall not exceed the purchase price of the component upon which liability is based. In no event shall OMEGA be liable for consequential, incidental or special damages.

CONDITIONS: Equipment sold by OMEGA is not intended to be used, nor shall it be used: (1) as a "Basic Component" under 10 CFR 21 (NRC), used in or with any nuclear installation or activity; or (2) in medical applications or used on humans. Should any Product(s) be used in or with any nuclear installation or activity, medical application, used on humans, or misused in any way, OMEGA assumes no responsibility as set forth in our basic WARRANTY/DISCLAIMER language, and, additionally, purchaser will indemnify OMEGA and hold OMEGA harmless from any liability or damage whatsoever arising out of the use of the Product(s) in such a manner.

RETURN REQUESTS/INQUIRIES

Direct all warranty and repair requests/inquiries to the OMEGA Customer Service Department. BEFORE RETURNING ANY PRODUCT(S) TO OMEGA, PURCHASER MUST OBTAIN AN AUTHORIZED RETURN (AR) NUMBER FROM OMEGA'S CUSTOMER SERVICE DEPARTMENT (IN ORDER TO AVOID PROCESSING DELAYS). The assigned AR number should then be marked on the outside of the return package and on any correspondence.

The purchaser is responsible for shipping charges, freight, insurance and proper packaging to prevent breakage in transit.

FOR **WARRANTY** RETURNS, please have the following information available BEFORE contacting OMEGA:

1. Purchase Order number under which the product was PURCHASED,
2. Model and serial number of the product under warranty, and
3. Repair instructions and/or specific problems relative to the product.

FOR **NON-WARRANTY** REPAIRS, consult OMEGA for current repair charges. Have the following information available BEFORE contacting OMEGA:

1. Purchase Order number to cover the COST of the repair,
2. Model and serial number of the product, and
3. Repair instructions and/or specific problems relative to the product.

OMEGA's policy is to make running changes, not model changes, whenever an improvement is possible. This affords our customers the latest in technology and engineering.

OMEGA is a registered trademark of OMEGA ENGINEERING, INC.

© Copyright 2012 OMEGA ENGINEERING, INC. All rights reserved. This document may not be copied, photocopied, reproduced, translated, or reduced to any electronic medium or machine-readable form, in whole or in part, without the prior written consent of OMEGA ENGINEERING, INC.

Where Do I Find Everything I Need for Process Measurement and Control? **OMEGA...Of Course!** *Shop online at omega.comSM*

TEMPERATURE

- ☑ Thermocouple, RTD & Thermistor Probes, Connectors, Panels & Assemblies
- ☑ Wire: Thermocouple, RTD & Thermistor
- ☑ Calibrators & Ice Point References
- ☑ Recorders, Controllers & Process Monitors
- ☑ Infrared Pyrometers

PRESSURE, STRAIN AND FORCE

- ☑ Transducers & Strain Gages
- ☑ Load Cells & Pressure Gages
- ☑ Displacement Transducers
- ☑ Instrumentation & Accessories

FLOW/LEVEL

- ☑ Rotameters, Gas Mass Flowmeters & Flow Computers
- ☑ Air Velocity Indicators
- ☑ Turbine/Paddlewheel Systems
- ☑ Totalizers & Batch Controllers

pH/CONDUCTIVITY

- ☑ pH Electrodes, Testers & Accessories
- ☑ Benchtop/Laboratory Meters
- ☑ Controllers, Calibrators, Simulators & Pumps
- ☑ Industrial pH & Conductivity Equipment

DATA ACQUISITION

- ☑ Data Acquisition & Engineering Software
- ☑ Communications-Based Acquisition Systems
- ☑ Plug-in Cards for Apple, IBM & Compatibles
- ☑ Data Logging Systems
- ☑ Recorders, Printers & Plotters

HEATERS

- ☑ Heating Cable
- ☑ Cartridge & Strip Heaters
- ☑ Immersion & Band Heaters
- ☑ Flexible Heaters
- ☑ Laboratory Heaters

ENVIRONMENTAL MONITORING AND CONTROL

- ☑ Metering & Control Instrumentation
- ☑ Refractometers
- ☑ Pumps & Tubing
- ☑ Air, Soil & Water Monitors
- ☑ Industrial Water & Wastewater Treatment
- ☑ pH, Conductivity & Dissolved Oxygen Instruments