



# User's Guide

*Shop online at*

**omega.com<sup>®</sup>**

Ω OMEGA<sup>®</sup>

*omega.com*

*e-mail: info@omega.com*

*For latest product manuals:*

*omegamanual.info*

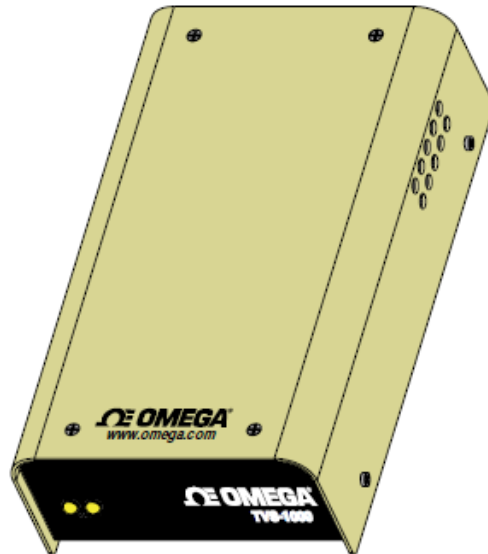

**ISO 9001**  
CERTIFIED  
CORPORATE QUALITY

STAMFORD, CT

**ISO 9002**  
CERTIFIED  
CORPORATE QUALITY

MANCHESTER, UK

## **TVS-1000 Series** **Temperature & Velocity Measurement System**

**omega.com®**

Ω OMEGA®

OMEGAnet® Online Service  
omega.com

Internet e-mail  
info@omega.com

### Servicing North America:

**U.S.A.:**  
ISO 9001 Certified

One Omega Drive, P.O. Box 4047  
Stamford, CT 06907-0047  
TEL: (203) 359-1660  
FAX: (203) 359-7700  
e-mail: info@omega.com

**Canada:**

976 Bergar  
Laval (Quebec) H7L 5A1, Canada  
TEL: (514) 856-6928  
FAX: (514) 856-6886  
e-mail: info@omega.ca

### For immediate technical or application assistance:

**U.S.A. and Canada:** Sales Service: 1-800-826-6342/1-800-TC-OMEGA®  
Customer Service: 1-800-622-2378/1-800-622-BEST®  
Engineering Service: 1-800-872-9436/1-800-USA-WHEN®

**Mexico:**

En Español: (001) 203-359-7803  
e-mail: espanol@omega.com  
FAX: (001) 203-359-7807  
info@omega.com.mx

### Servicing Europe:

**Czech Republic:** Frystatska 184, 733 01 Karviná, Czech Republic  
TEL: +420 (0)59 6311899  
FAX: +420 (0)59 6311114  
Toll Free: 0800-1-66342  
e-mail: info@omegashop.cz

**Germany/Austria:** Daimlerstrasse 26, D-75392 Deckenpfronn, Germany  
TEL: +49 (0)7056 9398-0  
FAX: +49 (0)7056 9398-29  
Toll Free in Germany: 0800 639 7678  
e-mail: info@omega.de

**United Kingdom:** One Omega Drive, River Bend Technology Centre  
ISO 9002 Certified  
Northbank, Irlam, Manchester  
M44 5BD United Kingdom  
TEL: +44 (0)161 777 6611  
FAX: +44 (0)161 777 6622  
Toll Free in United Kingdom: 0800-488-488  
e-mail: sales@omega.co.uk

---

It is the policy of OMEGA Engineering, Inc. to comply with all worldwide safety and EMC/EMI regulations that apply. OMEGA is constantly pursuing certification of its products to the European New Approach Directives. OMEGA will add the CE mark to every appropriate device upon certification.

The information contained in this document is believed to be correct, but OMEGA accepts no liability for any errors it contains, and reserves the right to alter specifications without notice.

**WARNING:** These products are not designed for use in, and should not be used for, human applications.

# CONTENTS

- 1- INTRODUCTION
  - 1.1 Introduction
  - 1.2 General Applications and Benefits
  - 1.3 Identification
  
- 2- HARDWARE
  
- 3- SOFTWARE DESCRIPTION
  - 3.1 Introduction
  - 3.2 *TVS-1000* software
  - 3.3 Software Installation
  
- 3. ELECTRICAL AND SYSTEM REQUIREMENTS
  - 4.1 Electrical and Safety Specifications
  - 4.2 System Requirements

## **SECTION 1: INTRODUCTION**

### **1.1 Introduction**

TVS-1000 is a hot wire anemometer system for measuring air temperature and velocity using single sensor technology. The device is connected to a PC or laptop through a USB port for communication between the software and the device. The system is capable of measuring temperatures from  $-10\text{ }^{\circ}\text{C}$  to  $120\text{ }^{\circ}\text{C}$  and flows from 0 to 10000 ft/min. The standard calibration is from 0 to 1200 lfm, the high speed calibration is from 0 to 10,000 lfm. The air temperature at which velocity is calibrated is from ambient to  $85\text{ }^{\circ}\text{C}$ . An attempt to measure flows in temperatures higher than  $85\text{ }^{\circ}\text{C}$ , would give erroneous data, even though it can read temperatures up to  $120\text{ }^{\circ}\text{C}$ .

### **1.2 General Applications and Benefits**

Heat sink manufacturers, IC houses, board designers and other electronic manufacturers are increasingly becoming interested in evaluating the thermal performance of their product under different airflow conditions. The reduction of electronic component sizes and increase in their power dissipation has forced the electronic community to be more aware of the thermal performance of their products. The hotter the devices, the shorter their life span and the greater the likelihood of a malfunction. The challenge in these units is the reduction in the spacing between boards, and thereby requiring small size sensors to measure air flow measurement. Of utmost importance is the measurement of air flow and temperature at the same point to minimize errors introduced as a result of temperature gradients. The conventional hot wire systems measure these two quantities using two independent sensors and, in most situations this can

introduce errors in excess of 40% due to temperature gradients and radiation coupling between the two sensors.

### **1.3 Identification**

The TVS-1000 is identified by OE followed by a 5 digit number (i.e. OE12345) located on the bottom of the unit.

## SECTION 2: HARDWARE DESCRIPTION

The TVS-1000 is housed in an electronic box, which accepts commands from the software through the USB communication port, and reports the data back to the system. It includes the circuitry for temperature and velocity sensors. Figure 1, shows the rear view of the TVS-1000 box.

**Note:** Please read the Manual before operating the system.

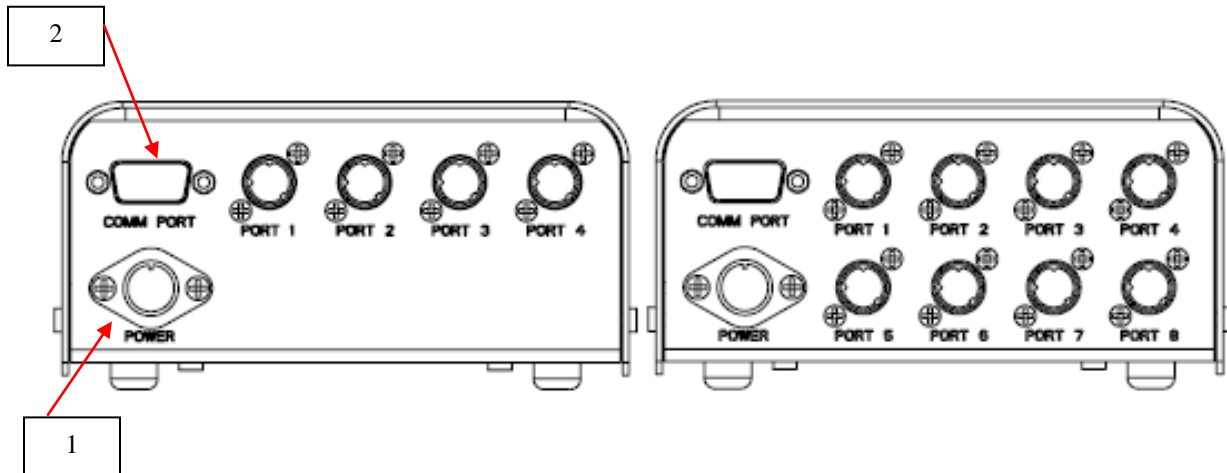

**Figure 1 – Rear Panels of the TVS-1000 and TVS-1008**

The function and description of ports and connectors on the rear panel are as follows:

- 1.- Power- This is the location for a connection to power supply. The external power supply provided with the system plugs in here.
- 2.- USB Port (Com Port)- The TVS-1000 is attached to the serial port of the PC with a straight cable through this port. **TVS-1000 comes with a 6 feet long standard USB cable.**

3.- Port#- Sensors are attached to the TVS-1000 through these ports. The order of attachment is immaterial, since each individual sensor has a sensor ID card which enables the system to find its calibration constants from a text file located in the PC C directory using its serial identification number.

## **SECTION 3: SOFTWARE DESCRIPTION**

### **3.1 Introduction**

**TVS-1000** software is a graphical user interface that communicates with the TVS box through the PC USB port. This software enables the user to set the different parameters and run the software to acquire the data.

#### THEORY OF OPERATION:

Data acquisition is comprised of cycles dictated by the duration set by the user in minutes. Each cycle consists of a selected number of temperature measurements followed by a selected number of velocity measurements. The selected number is set by the user. The cycles will continue until the time elapsed is greater than the duration. The user has the option to check the availability of the sensors and select which of those sensors he wants to collect data. Software also allows the user to save temperature and velocity raw data in text files that can be opened in Excel using tab delimited. The software has different controls and is described below:

### **3.2 TVS-1000 Software**

Figure 2 and 3 show the **TVS-1000** software main user interface when it is running.



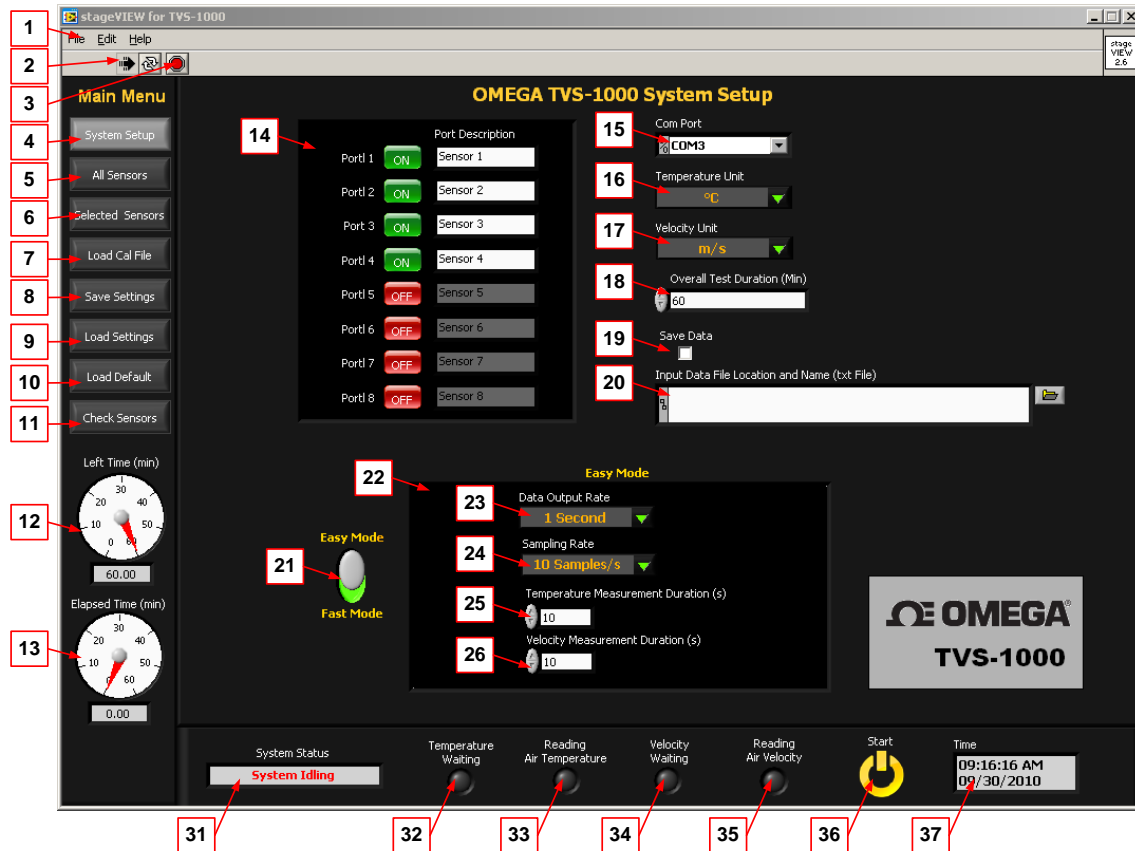

**Figure 2 - TVS-1000 User Interface**

The **TVS-1000** software interface has three functional areas: Main Menu selection on the left, display windows in the middle and status panel on the bottom. The user interface elements are explained as follows:

[1] **Windows Menu.** The windows menu includes File, Edit, and Help. The submenu of **File** includes,

**File—Start:** Select to start test.

**File—Stop:** Select to stop test.

**File—Exit:** Select to exit the software.

The submenu of **Edit** includes,

**Edit—Cut:** Cut content to clipboard.

**Edit—Copy:** Copy content to clipboard.

**Edit—Paste:** Paste content from clipboard.

The submenu of **Help** includes,

**Help—Show Context Help:** Select to open context help window.

- [2] **Run Button:** Push this button to start program.
- [3] **Stop Button:** Push this button to stop program.
- [4] **System Setup:** Push this button to display **System Setup** window.
- [5] **All Sensors:** Push this button to display **View All Sensors** window (See Figure 3).
- [6] **Selected Sensors:** Push this button to display **View Selected Sensors** window (See Figure 4).
- [7] **Load Cal File:** Push this button to reload the sensor calibration file.
- [8] **Save Settings:** Push this button to save the system configuration to a text file.
- [9] **Load Settings:** Load system configuration from a previously saved text file.
- [10] **Load Default:** Push this button to load the default system configuration.
- [11] **Check TVS Sensors:** Push this button to display **Check TVS Sensors** window (See Figure 5).
- [12] **Left Time (min):** Display of test time remaining in minutes.
- [13] **Elapsed Time (min):** Display of elapsed test time in minutes.
- [14] **Port Selection Window:** Select or unselect ports for air temperature and velocity measurement, enter port description.
- [15] **Com Port:** Select the communication port that connects to the **TVS-1000** instrument.
- [16] **Temperature Unit:** Choose the unit for temperature.
- [17] **Velocity Unit:** Choose the unit for velocity.
- [18] **Overall Test Duration (Min):** Enter the total test duration time in minutes.
- [19] **Save Data:** Select to save measurement data.

- [20] **Input Data File Location and Name (txt File):** When you specify a file name such as **Test.txt** the software will automatically generate two files to record data.
- a) **Test.txt** for temperature data and velocity data
  - b) **Test-Temperature.txt** for temperature data
- [21] **Sampling Mode:** Choose if you want easy mode or fast mode
- [22] **Easy Mode:** In this mode, users can specify data output rate and sampling rates.
- [23] **Data Output Rate:** Choose the time interval to average measurement and update data. Displaying plots and tables will update data at this time rate. Measurement data will be saved at this time rate too.
- [24] **Sampling Rate:** Choose the sampling rate from the pull-down menu. The menu will update its selections according to the total number of sensors chosen. The more sensors that are chosen, the smaller is the sampling rate.
- [25] **Temperature Measurement Duration (s):** Set the duration in seconds for temperature measurement per scan.
- [26] **Velocity Measurement Duration (s):** Set the duration in seconds to velocity measurement per scan.

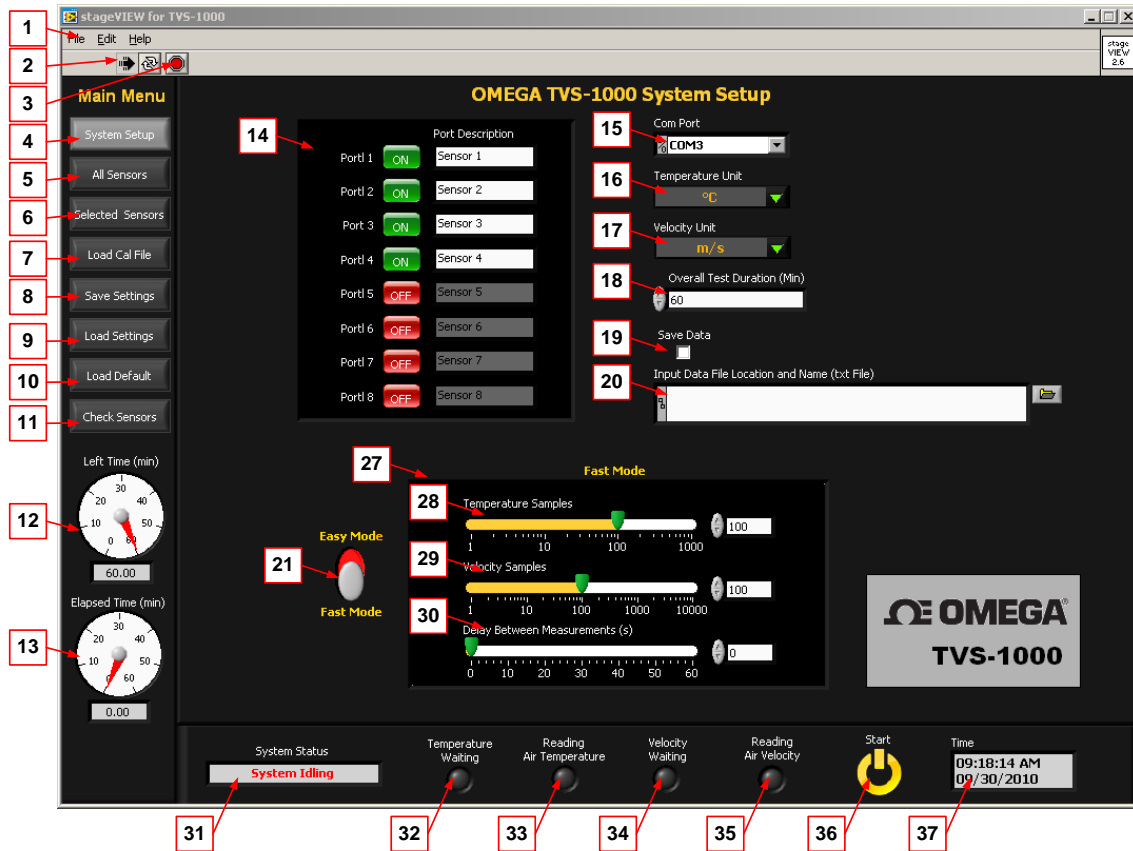

**Figure 3 - TVS-1000 User Interface**

- [27] **Fast Mode:** In this mode, users can take the fast measurement of temperature and velocity.
- [28] **Temperature Samples:** The number of temperature measurements will be taken per scan.
- [29] **Velocity Samples:** The number of velocity measurements will be taken per scan.
- [30] **Delay Between Measurements (seconds):** Specify the delay between two adjacent scans.
- [31] **System Status:** The display of system status information.
- [32] **Temperature Waiting:** The LED for temperature setting indication.
- [33] **Reading Air Temperature:** The LED for air temperature measuring indication.

- [34] **Velocity Waiting:** The LED for velocity setting indication.
- [35] **Reading Air Velocity:** The LED for air velocity measuring indication.
- [36] **Start/Stop:** Click **Start** to initialize test. In the test, click **Stop** to end the test.
- [37] **Time:** The current date and time.

**CAUTION: When the sensor is in velocity mode its temperature will be in excess of 160 °C. Please take precaution not to touch the sensors when they are running. Touching them can cause skin burning.**



**Figure 4 - TV5-1000 User Interface**

Figure 4 shows the **View All Sensors** window and the user interface elements are explained as follows,

- [1] **Air Temperature Plot:** Displays air temperature measured by TVS sensors.
- [2] **Air Temperature Plot Digital Display**
- [3] **Export Plot:** Push to export the **Air Temperature Plot** to a BMP file.
- [4] **Air Temperature Plot Control:** Plot control to change X Scale/Y Scale mode.
- [5] **Save T Summary:** Push to save the content of the **Air Temperature Summary** table to a file.
- [6] **Air Temperature Summary:** This table displays the summary of each sensor temperature reading and updates its results according to **Measurement Duration** setting.
- [7] **Air Velocity Plot:** Displays air velocity measured by TVS-1000 sensors.
- [8] **Air Velocity Plot Digital Display**
- [9] **Air Temperature/Velocity Plot Legend**
- [10] **Export Plot:** Push to export the **Air Velocity Plot** to a BMP file.
- [11] **Air Velocity Plot Control:** Plot control to change X Scale/Y Scale mode.
- [12] **Save V Summary:** Push to save the content of the **Air Velocity Summary** table to a file.
- [13] **Air Velocity Summary:** This table displays the summary of each TVS-1000 sensor velocity reading and updates its results according to **Measurement Duration** setting.

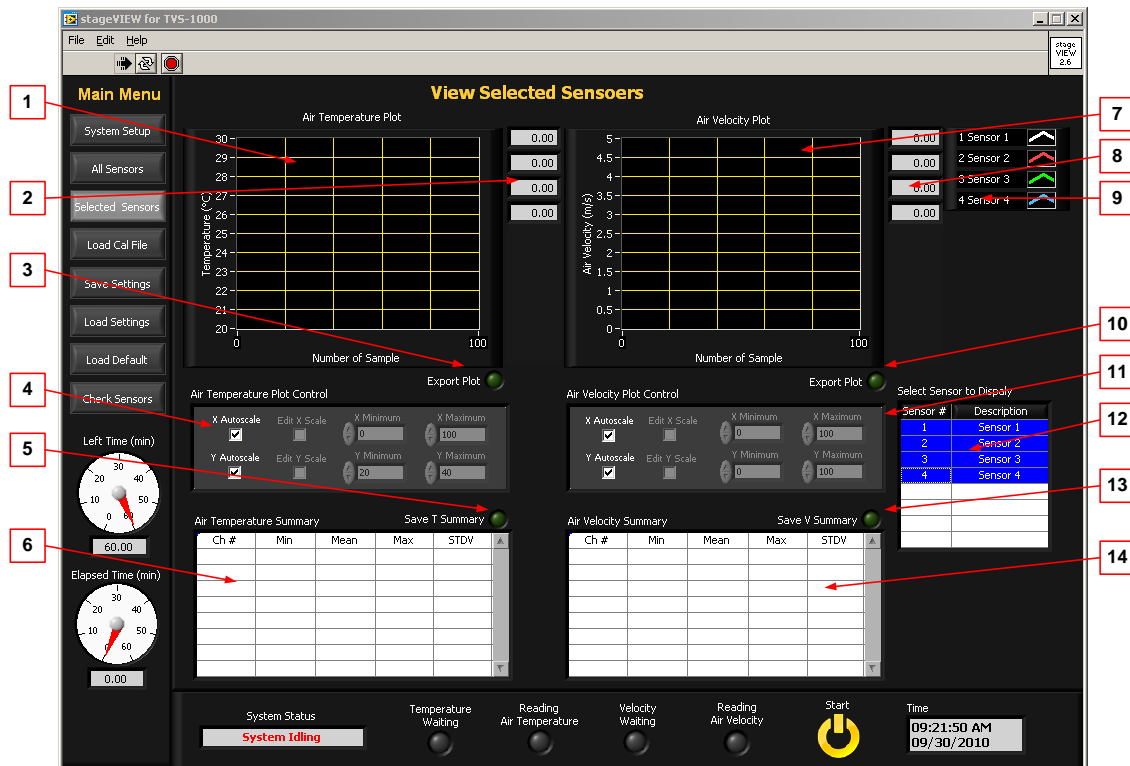

**Figure 5 - TVS-1000 User interface**

Figure 5 shows the **TVS-1000** software user interface when selecting **View Selected Sensors** in the main menu is selected. The user interface elements are explained as follows:

- [1] **Air Temperature Plot:** Display air temperature measured by the TVS-1000 sensors.
- [2] **Air Temperature Plot Digital Display**
- [3] **Export Plot:** Push to export the **Air Temperature Plot** to a BMP file.
- [4] **Air Temperature Plot Control:** Plot control to change X Scale/Y Scale mode.
- [5] **Save T Summary:** Push to save the content of the **Air Temperature Summary** table to a file.

- [6] **Air Temperature Summary:** This table displays the summary of each TVS-1000 sensor temperature reading and updates its results according to **Measurement Duration** setting.
- [7] **Air Velocity Plot:** Display air velocity measured by TVS-1000 sensors.
- [8] **Air Velocity Plot Digital Display**
- [9] **Air Temperature/Velocity Plot Legend**
- [10] **Export Plot:** Push to export the **Air Velocity Plot** to a BMP file.
- [11] **Air Velocity Plot Control:** Plot control to change X Scale/Y Scale mode.
- [12] **Select Sensor to Display:** Click to select the sensor to display in the plots, you can select multiple sensors by push **Ctrl** Button.
- [13] **Save V Summary:** Push to save the content of the **Air Velocity Summary** table to a file.
- [14] **Air Velocity Summary:** This table displays the summary of each TVS-1000 sensor velocity reading and updates its results according to the **Measurement Duration** setting.



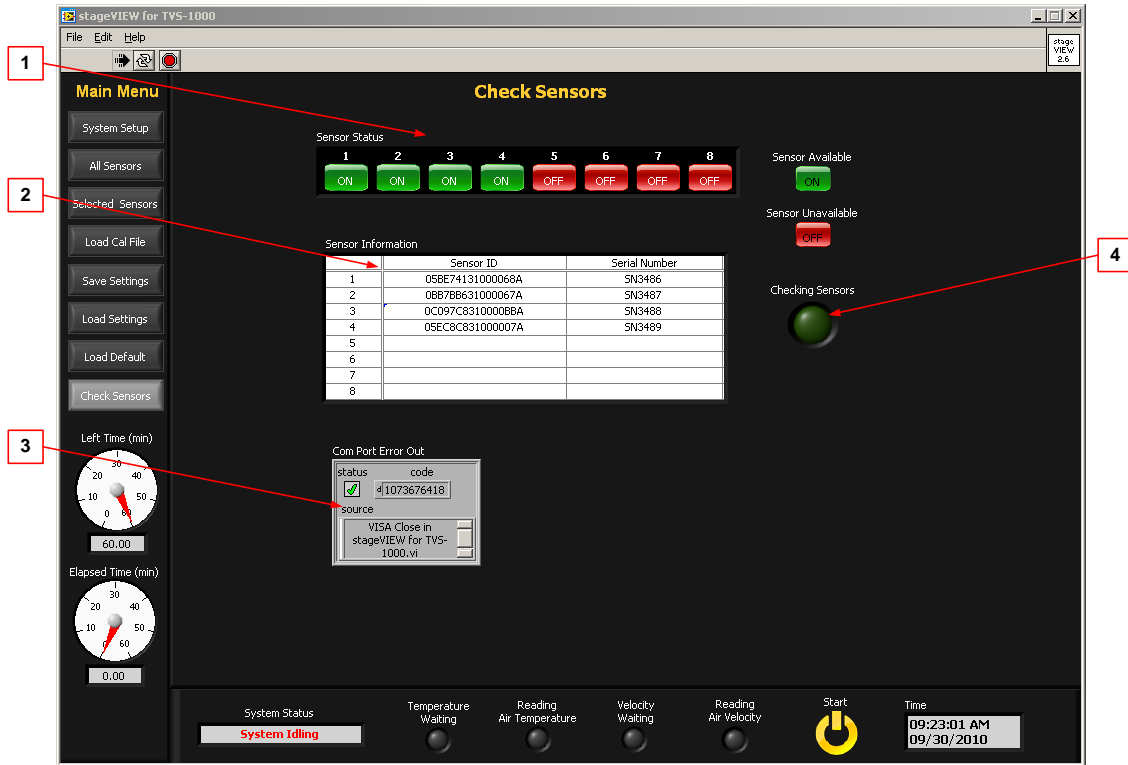

**Figure 6 - TVS-1000 User Interface**

Figure 6 shows the **TVS-1000** software user interface when **Check Sensor** in main menu is selected. The user interface elements are explained as follows:

- [1] **Sensor Status:** Display the TVS sensor availability.
- [2] **Sensor Information:** Display the TVS sensor ID and serial number.
- [3] **Com Port Error Out:** Display Com port information.
- [4] **Checking Sensors:** Sensor checking progress indicator.

### 3.3 Software Installation

In order to install the **TVS-1000** software, please follow the following steps:

1. Install the software by double clicking on **TVS-1000\Volume\setup.exe**. It installs the **TVS-1000** and supporting files to your computer.

2. Install **National Instruments** serial communication driver by double clicking on **Drivers\NI-Serial 3.5\Setup.exe**

**Note: NI-Serial 3.5 supports the following operating system:  
Windows 2000; Windows XP; Windows Vista; Windows Vista x64.**

**NI-Serial 3.6 Supports the following operating system: Windows 7  
64 bit; Windows 7 x86; Windows XP x86; Windows Server 2008 R2  
(64-bit); Windows Vista x64; Windows Vista x86; Windows Server  
2003 R2 (32-bit).**

3. Install the USB driver by double clicking on **Download folder  
\Drivers\FTDI USB-RS232 driver \USB-RS232 driver.exe.**
4. **When you run TVS-1000 for the first time**, a window (see Figure 7 will pop out asking for **ATVS-2020 calibration data.txt** file. You have to load this file before using the **TVS-1000**.

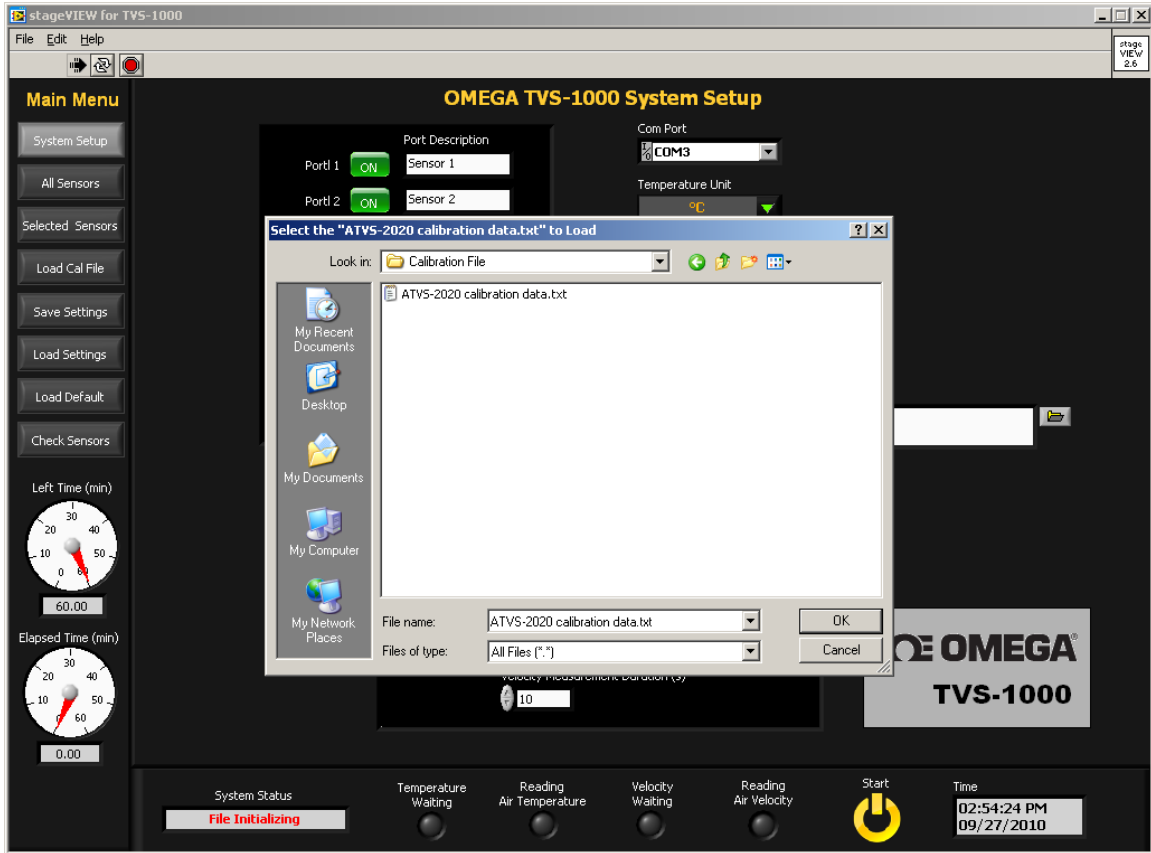

**Figure 7 - Load Calibration File for TVS-1000**

## **SECTION 4: ELECTRICAL AND SYSTEM REQUIREMENTS**

### **4.1 Electrical and Safety Specifications**

- Products destined for the North American market are furnished with a cord set. Outside of North America, a detachable cord set compliant with the local electrical safety and code requirements is necessary. The cord set shall have a female fitting MAINS connector according to IEC 60320 and shall either meet the requirements of IEC 60799 or shall be rated for maximum current ratings of the equipment (1.5 A). The length of the cord set must be less than 3 meters long.
- The system is powered by a DC power supply with the following specifications:

Separable power supply:

Input: 100-240 V, 1.5A, 60-50 HZ

Output: +5Vdc, 5A, +15Vdc, 2A, -15Vdc, 0.8A

The power supply provided should be used to maintain acceptable safety of the unit. Contact Omega for repairs and replacement.

#### **4.1.1 Description of Connectors**

- The DIN mount receptacle accepts DC voltages from the specified power supply.
- The sensor connectors receive voltages from sensors. The system will not function properly with any other sensor other than the one supplied by Omega.

- The DB9 connector is used with a straight cable to communicate with a PC or laptop through the COM port.

#### **4.1.2 Description of the Symbol**



The above symbol indicates caution, risk of danger. Documentation must be consulted where this symbol is marked. There are no user serviceable parts inside. It is not recommended that the user open the electronic box or the power supply unit.

## **4.2 System and Environmental Requirements**

Environmental conditions:

This equipment is designed to be safe at least under the following conditions:

- Indoor use
- Altitude up to 2000 m.
- Temperatures from 5 C to 40 °C.
- Maximum relative humidity, 80% for temperatures up to 31 °C decreasing linearly to 50% relative humidity at 40 °C.

Installation/overvoltage category: II

Pollution degree: 2

Degree of protection to IEC 60529: IPK0

Equipment mobility: Portable

Connection to mains supply: Detachable cord set

Operating conditions : Continuous (duration of operation set by operator through software)

- Unit can be mounted in any orientation as long as it is securely mounted.
- Connect the power supply to a grounding type receptacle.
- The cord set is the disconnect device. Position the equipment to facilitate disconnect from Mains as necessary.
- The system does not require any cleaning or decontamination .

System requirements:

- Use a PC or laptop with a minimum of 512 MB of memory and an operating systems windows 2000, XP, Vista, and 7. To maintain an acceptable level of safety, the host computer should comply with the requirements of UL/CSA/IEC 60950.

It is recommended that the sensors be calibrated on an annual basis.





## WARRANTY/DISCLAIMER

OMEGA ENGINEERING, INC. warrants this unit to be free of defects in materials and workmanship for a period of **13 months** from date of purchase. OMEGA's WARRANTY adds an additional one (1) month grace period to the normal **one (1) year product warranty** to cover handling and shipping time. This ensures that OMEGA's customers receive maximum coverage on each product.

If the unit malfunctions, it must be returned to the factory for evaluation. OMEGA's Customer Service Department will issue an Authorized Return (AR) number immediately upon phone or written request. Upon examination by OMEGA, if the unit is found to be defective, it will be repaired or replaced at no charge. OMEGA's WARRANTY does not apply to defects resulting from any action of the purchaser, including but not limited to mishandling, improper interfacing, operation outside of design limits, improper repair, or unauthorized modification. This WARRANTY is VOID if the unit shows evidence of having been tampered with or shows evidence of having been damaged as a result of excessive corrosion; or current, heat, moisture or vibration; improper specification; misapplication; misuse or other operating conditions outside of OMEGA's control. Components in which wear is not warranted, include but are not limited to contact points, fuses, and triacs.

**OMEGA is pleased to offer suggestions on the use of its various products. However, OMEGA neither assumes responsibility for any omissions or errors nor assumes liability for any damages that result from the use of its products in accordance with information provided by OMEGA, either verbal or written. OMEGA warrants only that the parts manufactured by the company will be as specified and free of defects. OMEGA MAKES NO OTHER WARRANTIES OR REPRESENTATIONS OF ANY KIND WHATSOEVER, EXPRESSED OR IMPLIED, EXCEPT THAT OF TITLE, AND ALL IMPLIED WARRANTIES INCLUDING ANY WARRANTY OF MERCHANTABILITY AND FITNESS FOR A PARTICULAR PURPOSE ARE HEREBY DISCLAIMED. LIMITATION OF LIABILITY: The remedies of purchaser set forth herein are exclusive, and the total liability of OMEGA with respect to this order, whether based on contract, warranty, negligence, indemnification, strict liability or otherwise, shall not exceed the purchase price of the component upon which liability is based. In no event shall OMEGA be liable for consequential, incidental or special damages.**

CONDITIONS: Equipment sold by OMEGA is not intended to be used, nor shall it be used: (1) as a "Basic Component" under 10 CFR 21 (NRC), used in or with any nuclear installation or activity; or (2) in medical applications or used on humans. Should any Product(s) be used in or with any nuclear installation or activity, medical application, used on humans, or misused in any way, OMEGA assumes no responsibility as set forth in our basic WARRANTY/DISCLAIMER language, and, additionally, purchaser will indemnify OMEGA and hold OMEGA harmless from any liability or damage whatsoever arising out of the use of the Product(s) in such a manner.

## RETURN REQUESTS/INQUIRIES

Direct all warranty and repair requests/inquiries to the OMEGA Customer Service Department. BEFORE RETURNING ANY PRODUCT(S) TO OMEGA, PURCHASER MUST OBTAIN AN AUTHORIZED RETURN (AR) NUMBER FROM OMEGA'S CUSTOMER SERVICE DEPARTMENT (IN ORDER TO AVOID PROCESSING DELAYS). The assigned AR number should then be marked on the outside of the return package and on any correspondence.

The purchaser is responsible for shipping charges, freight, insurance and proper packaging to prevent breakage in transit.

FOR **WARRANTY** RETURNS, please have the following information available BEFORE contacting OMEGA:

1. Purchase Order number under which the product was PURCHASED,
2. Model and serial number of the product under warranty, and
3. Repair instructions and/or specific problems relative to the product.

FOR **NON-WARRANTY** REPAIRS, consult OMEGA for current repair charges. Have the following information available BEFORE contacting OMEGA:

1. Purchase Order number to cover the COST of the repair,
2. Model and serial number of the product, and
3. Repair instructions and/or specific problems relative to the product.

OMEGA's policy is to make running changes, not model changes, whenever an improvement is possible. This affords our customers the latest in technology and engineering.

OMEGA is a registered trademark of OMEGA ENGINEERING, INC.

© Copyright 2008 OMEGA ENGINEERING, INC. All rights reserved. This document may not be copied, photocopied, reproduced, translated, or reduced to any electronic medium or machine-readable form, in whole or in part, without the prior written consent of OMEGA ENGINEERING, INC.



**Where Do I Find Everything I Need for  
Process Measurement and Control?  
OMEGA...Of Course!  
Shop online at [omega.com](http://omega.com)<sup>SM</sup>**

**TEMPERATURE**

- ☑ Thermocouple, RTD & Thermistor Probes, Connectors, Panels & Assemblies
- ☑ Wire: Thermocouple, RTD & Thermistor
- ☑ Calibrators & Ice Point References
- ☑ Recorders, Controllers & Process Monitors
- ☑ Infrared Pyrometers

**PRESSURE, STRAIN AND FORCE**

- ☑ Transducers & Strain Gages
- ☑ Load Cells & Pressure Gages
- ☑ Displacement Transducers
- ☑ Instrumentation & Accessories

**FLOW/LEVEL**

- ☑ Rotameters, Gas Mass Flowmeters & Flow Computers
- ☑ Air Velocity Indicators
- ☑ Turbine/Paddlewheel Systems
- ☑ Totalizers & Batch Controllers

**pH/CONDUCTIVITY**

- ☑ pH Electrodes, Testers & Accessories
- ☑ Benchtop/Laboratory Meters
- ☑ Controllers, Calibrators, Simulators & Pumps
- ☑ Industrial pH & Conductivity Equipment

**DATA ACQUISITION**

- ☑ Data Acquisition & Engineering Software
- ☑ Communications-Based Acquisition Systems
- ☑ Plug-in Cards for Apple, IBM & Compatibles
- ☑ Datalogging Systems
- ☑ Recorders, Printers & Plotters

**HEATERS**

- ☑ Heating Cable
- ☑ Cartridge & Strip Heaters
- ☑ Immersion & Band Heaters
- ☑ Flexible Heaters
- ☑ Laboratory Heaters

**ENVIRONMENTAL  
MONITORING AND CONTROL**

- ☑ Metering & Control Instrumentation
- ☑ Refractometers
- ☑ Pumps & Tubing
- ☑ Air, Soil & Water Monitors
- ☑ Industrial Water & Wastewater Treatment
- ☑ pH, Conductivity & Dissolved Oxygen Instruments

M-4557/0911