

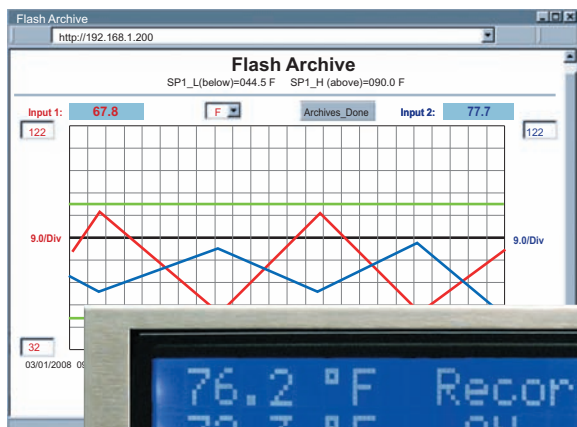

User's Guide



Shop on line at

omega.com[®]

Ω OMEGA

omega.com

e-mail: info@omega.com

For Latest Product Manuals

omegamanual.info

iSE-TC[®]

Dual Thermocouple over the Internet



OMEGAnet® On-Line Service www.omega.com	Internet e-mail info@omega.com
--	--

Servicing North America:

USA: One Omega Drive, P.O. Box 4047
ISO 9001 Certified Stamford CT 06907-0047
TEL: (203) 359-1660 FAX: (203) 359-7700
e-mail: info@omega.com

Canada: 976 Bergar
Laval (Quebec) H7L 5A1
TEL: (514) 856-6928 FAX: (514) 856-6886
e-mail: info@omega.ca

For immediate technical or application assistance:

USA and Canada: Sales Service: 1-800-826-6342 / 1-800-TC-OMEGA®
Customer Service: 1-800-622-2378 / 1-800-622-BEST®
Engineering Service: 1-800-872-9436 / 1-800-USA-WHEN®

Mexico and Latin American: TEL: (001) 203-359-7803 FAX: (001) 203-359-7807
e-mail: espanol@omega.com

Servicing Europe:

Benelux: TEL: +31 20 3472121 FAX: +31 20 6434643
Toll Free in Benelux: 0800 0993344
e-mail: sales@omegaeng.nl

Czech Republic: Frystatska 184, 733 01 Karviná
TEL: +420 59 6311899 FAX: +420 59 6311114
e-mail: info@omegashop.cz

France: TEL: +33 1 61 37 29 00 FAX: +33 1 30 57 54 27
Toll Free in France: 0800 466 342
e-mail: sales@omega.fr

Germany/Austria: Daimlerstrasse 26, D-75392 Deckenpfronn, Germany
TEL: +49 7056 9398-0 FAX: +49 7056 9398-29
Toll Free in Germany: 0800 639 7678
e-mail: info@omega.de

United Kingdom: One Omega Drive
ISO 9001 Certified River Bend Technology Centre
Northbank, Irlam Manchester M44 5BD United Kingdom
TEL: +44 161 777 6611 FAX: +44 161 777 6622
Toll Free in England: 0800 488 488
e-mail: sales@omega.co.uk

It is the policy of OMEGA to comply with all worldwide safety and EMC/EMI regulations that apply. OMEGA is constantly pursuing certification of its products to the European New Approach Directives. OMEGA will add the CE mark to every appropriate device upon certification.

The information contained in this document is believed to be correct, but OMEGA Engineering, Inc. accepts no liability for any errors it contains, and reserves the right to alter specifications without notice.

WARNING: These products are not designed for use in, and should not be used for, patient-connected applications.



This device is marked with the international caution symbol. It is important to read the Setup Guide before installing or commissioning this device as the guide contains important information relating to safety and EMC.

TABLE OF CONTENTS

Part 1: Introduction		
1.1	Safety and EMC Considerations	2
1.2	Before You Begin	2
1.3	Description	2
Part 2: Hardware		
2.1	Wall Mounting	5
2.2	DIP Switches	6
2.3	Parts of the ISE Unit	7
2.4	Disassembly Instruction	8
2.5	Network Communication Interfaces	9
	2.5.1 10Base-T RJ-45 Pinout	9
	2.5.2 10Base-T Crossover Wiring	9
2.6	Relay and I/O Contact Wiring Connections	9
2.7	DC Power Input Wiring Connections	9
2.8	Running on Battery Power	10
2.9	Flash Memory Format	11
Part 3: Network Configuration		
3.1	Network Protocols	12
3.2	Ethernet (MAC) Address	12
3.3	DHCP	13
3.4	DNS	13
3.5	IP Address	13
	3.5.1 Default IP Address	14
3.6	Port Number	14
Part 4: Operations		
4.0	Testing the Connection	15
4.1	iConnect Software	16
4.2	Setting a new IP Address over the Network	18
4.3	Setup and Operation using the iSE Web Page	19
	4.3.1 Read Sensor	20
	4.3.1.1 Java Runtime Environment 1.4 Setup Instructions	20
	4.3.1.2 Java Runtime Environment 1.5 (5.0) Setup Instructions	21
	4.3.1.3 Browser Proxy Selection	21
	4.3.2 Adjustable Chart	22
	4.3.3 Retrieving Data from Flash	23
	4.3.4 Access Control	24
	4.3.5 Configuration	25
	4.3.6 Sensor Parameter	31
4.4	Telnet Setup	34
4.5	HTTPget Program	34
	4.5.1 HTTPget using Port 1000	35
	4.5.2 HTTPget and ARP to setup Device IP Address	37
4.6	ARP Protocol	38
4.7	iLog Software	39
4.8	Mail Notifier Software	40
	4.8.1 Installation	40
	4.8.2 Program Options Setup and Configuration	41
	4.8.3 Device Setting Setup and Configuration	42
Part 5: Specifications		43
Part 6: Factory Preset Values		45
Part 7: Approval Information		46
Appendix A	Glossary	47
Appendix B	IP Address	48
Appendix C	IP Netmask	49
Appendix D	ASCII Chart	50
	ASCII Chart Control Codes	51
Appendix E	iLog Error Messages	52

LIST OF FIGURES:

Figure 1.1	iSE and iLD Big Display on the Ethernet Network	4
Figure 2.1	Mounting	5
Figure 2.2	Dimensions	5
Figure 2.3	DIP Switch Location.....	6
Figure 2.4	Parts of the iSE Unit.....	7
Figure 2.5	Opening the Unit	8
Figure 2.6	RJ45 Pinout	9
Figure 2.7	10Base-T Crossover Cable Wiring	9
Figure 2.8	Relay and I/O Contact Connections	9
Figure 2.9	Battery and S5 Jumper Location	10
Figure 2.10	Chart of Simulated Data.....	11
Figure 3.1	Labeling	12
Figure 3.2	DIP Switch on the Bottom Side of iSE.....	13
Figure 3.3	Telnet Login into the iSE	14
Figure 4.1	Pinging the iSE from MS-DOS Prompt	15
Figure 4.2	Assigning an IP Address using iConnect	16
Figure 4.3	Accessing the iSE's Home Page Menu	17
Figure 4.4	Access Control	18
Figure 4.5	iSE Home Page	19
Figure 4.6	LOGIN and ADMINISTRATOR Passwords	19
Figure 4.7	Read Sensor	20
Figure 4.8	Adjustable Chart.....	22
Figure 4.9	iFlash Download Utility.....	23
Figure 4.10	Access Control	24
Figure 4.11	Configuration	26
Figure 4.12	Sensor Parameters - Temperature	31
Figure 4.13	Sensor Parameters - Input Contact	32
Figure 4.14	Remote End Char	33
Figure 4.15	ARP Commands and Responses	38
Figure 4.16	iLog Software Logging Data.....	39
Figure 4.17	iSE Mail Notifier Main Window	40
Figure 4.18	iSE Mail Notifier Profile Setup.....	41
Figure 4.19	iSE Mail Notifier Device Setting	42

LIST OF TABLES:

Table 2.1	Parts of iSE Unit.....	7
-----------	------------------------	---

NOTES, WARNINGS and CAUTIONS

Information that is especially important to note is identified by the following labels:

- **NOTE**
- **WARNING or CAUTION**
- **IMPORTANT**
- **TIP**



NOTE: Provides you with information that is important to successfully setup and use the iSE.



CAUTION: Tells you about the risk of electrical shock.



CAUTION: Risk of danger. Tells you of circumstances or practices that can effect the instrument's functionality and must refer to accompanying documents.



TIP: Provides you helpful hints.

FEATURES

- **Two Temperature Channels**
- **Web Server**
- **Virtual Chart Recorder**
- **Two Relay Alarms**
- **Two Contact Closures**
- **Accurate Readings**
- **Password Protection**
- **Email Alarms**
- **Data Logging**
- **2, 4 or 8M bytes Flash Memory Card**
- **Real-Time Clock**
- **LCD Display**
- **UPS / Stand-alone 9Vdc Battery**

PART 1

INTRODUCTION

1.1 Safety and EMC Considerations

Refer to the CE Approvals Section.

EMC Considerations

- Whenever EMC is an issue, always use shielded cables.
- Never run signal and power wires in the same conduit.
- Use twisted-pair wires for signal connections.
- Install Ferrite Bead(s) on signal wires close to the instrument if EMC problems persist.

Failure to follow all instructions and warnings may result in injury!

1.2 Before You Begin

Inspecting Your Shipment: Remove the packing slip and verify that you have received everything listed. Inspect the container and equipment for signs of damage as soon as you receive the shipment. Note any evidence of rough handling in transit. Immediately report any damage to the shipping agent. The carrier will not honor damage claims unless all shipping material is saved for inspection. After examining and removing the contents, save the packing material and carton in the event reshipment is necessary.

Customer Service: If you need assistance, please contact the Customer Service Department nearest you.

Manuals, Software: The latest Operation Manual as well as free configuration software (iConnect), datalogging software (iLog), download utility (iFlash), and Mail Notifier are available at **the website listed on the cover page of this manual or on the CD-ROM enclosed with your shipment.**

1.3 Description

Web-based Remote Surveillance of Temperature and Security

The iSE environmental monitor provides Web-based remote surveillance of environmental conditions in critical HVAC applications such as computer server rooms, clean rooms, laboratories, museums, warehouses, or any remote facility. View and record Temperature on two independent thermocouple channels, over an Ethernet network or the Internet with no special software—just a Web browser.

EMAIL ALARMS -- The device can trigger an alarm if temperature goes above or below a set point that you determine. Your alarm can be sent by email to a single user or to a group distribution list, including text messages to cell phones and PDA's.

PHYSICAL THREATS -- The iSE includes screw terminals for two contact closures that work with common alarm sensors. You can instruct the iSE monitor to send an alarm if a door is opened, a window is broken, or a fire sprinkler goes off.

POWER FAILURE -- The iSE monitor can trigger an alarm if the AC power fails. The iSE monitor will continue to collect data for ten days powered by a standard 9 Volt alkaline battery (included). The data is stored in nonvolatile flash memory and can later be downloaded over the Ethernet.

LOCAL ALARMS -- The iSE includes two 1.5 Amp output relays that are controlled by the alarm conditions you select. The relays can trigger flashing lights and a siren for example to alert personnel near the scene.

With the easy Web-based setup page, the two relays can be programmed for two temperature inputs, and high or low set points, as well as alarm conditions triggered by contact closures. The relays can also be programmed to turn off when conditions return to normal, or programmed to remain latched and require a manual reset.

VIEW CHARTS AND GRAPHS ON THE WEB -- The iSE serves Active Web Pages to display real time readings, display charts of temperature, or log data in standard data formats for use in a spreadsheet or data acquisition program such as Excel or Visual Basic.

The virtual chart viewed on the web page is a JAVA™ Applet that records a chart over the LAN or Internet in real time. With the iSE, there is no need to invest time and money learning a proprietary software program to log or chart the data.

Chart scales are fully adjustable on the fly. For example, the chart can display one minute, one hour, one day, one week, one month or one year. Temperature can be charted across the full span or within any narrow range.

You can chart temperature from one thermocouple, two thermocouples, and/or the differential between the two. The iSE can take thermocouple types J, K, T, E, R, S, B, C, N and L measuring temperatures up to 1,820°C (3,308°F). The iSE can display and chart absolute measurements in two locations and a differential measurement between the two locations. The iSE comes with a pair of type K thermocouples.

LINK TO WEB CAM OR IP CAMERA -- The Web page includes a link to a "Web Cam" or "IP camera" (not included). If you get a message about an alarm condition, you can quickly click on the link to view the actual scene over the Internet.

FLASH MEMORY -- The iSE records data on a removable 2-MByte Flash Memory card (included) that can store one full year of readings taken at one-minute intervals (or two months of readings taken at ten second intervals).

Up to four years of temperature readings can be stored on the optional 8 MByte card. Even if the Ethernet network fails, data will continuously record on the built-in nonvolatile flash memory.

Installation and operation of the iSE monitor requires no special training, tools, or software. The device connects to any Ethernet network with standard cable and is powered by a universal AC adapter which is supplied with the product.

AWARD-WINNING TECHNOLOGY -- The iSE is simple to install and use, and features award-winning iServer technology that requires no special software except a Web Browser.

The iSE connects to an Ethernet Network with a standard RJ45 connector and sends data in standard TCP/IP packets. It is easily configured with a simple menu using a Web Browser and can be password protected. From within an Ethernet LAN or over the Internet, the user simply types its IP address or an easy to remember name such as "Cleanroom 5" or "Server Room" in any Web Browser, and the iSE serves a Web Page with the current readings.

TYPICAL APPLICATIONS -- The iSE is great for monitoring and recording temperature in applications such as: clean rooms, computer rooms, HVAC systems, pharmaceutical and food processing and storage, hospitals, laboratories, semiconductor fabs, electronic assembly, warehousing, museums, manufacturing, greenhouses, farm animal shelters, and many more.

The following example illustrates how you can hookup an iSE, a network display (iLD), and a network camera to your network:

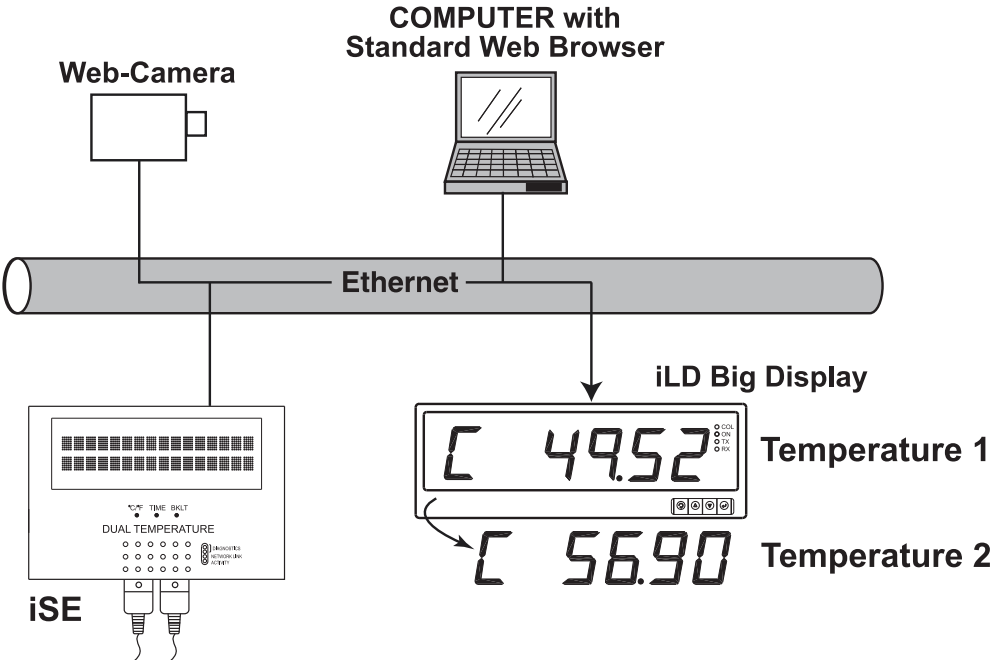

Figure 1.1 iSE and iLD Big Display on the Ethernet Network

PART 2 HARDWARE

2.1 Wall Mounting

Position unit where required. Mark and drill the two #4 screw holes.

After bracket is mounted on the wall, align back of unit over the three bracket clips, once engaged, slide downward, the unit will snap in place.

For extra security, you may screw the unit onto the bracket. Remove cover (see **Section 2.4**) and screw a #4 x 1/4" long self-tapping screw through the case and bracket.

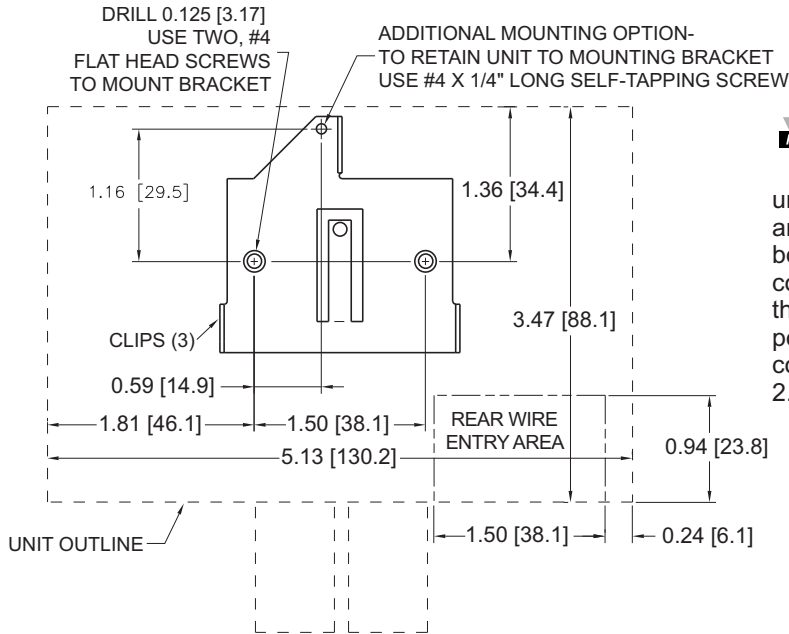

Note It is recommended that you ground your unit by wrapping a wire around the case's bottom screw or by connecting a wire to the Return/Ground position of the relay connector (see Figure 2.8 and 3.1).

Figure 2.1 Mounting

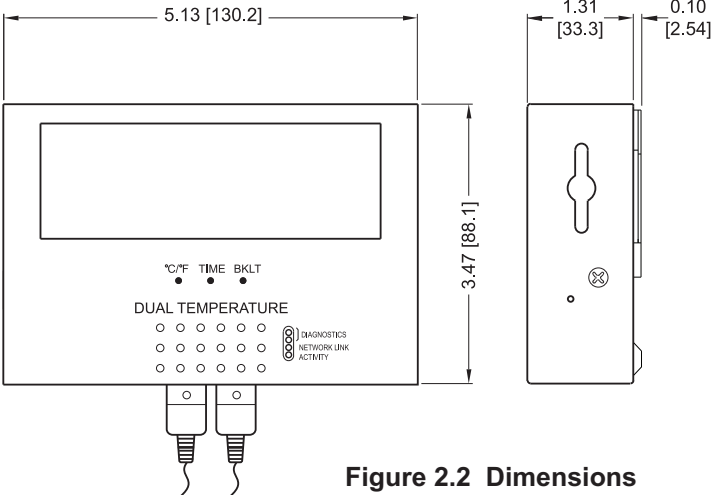
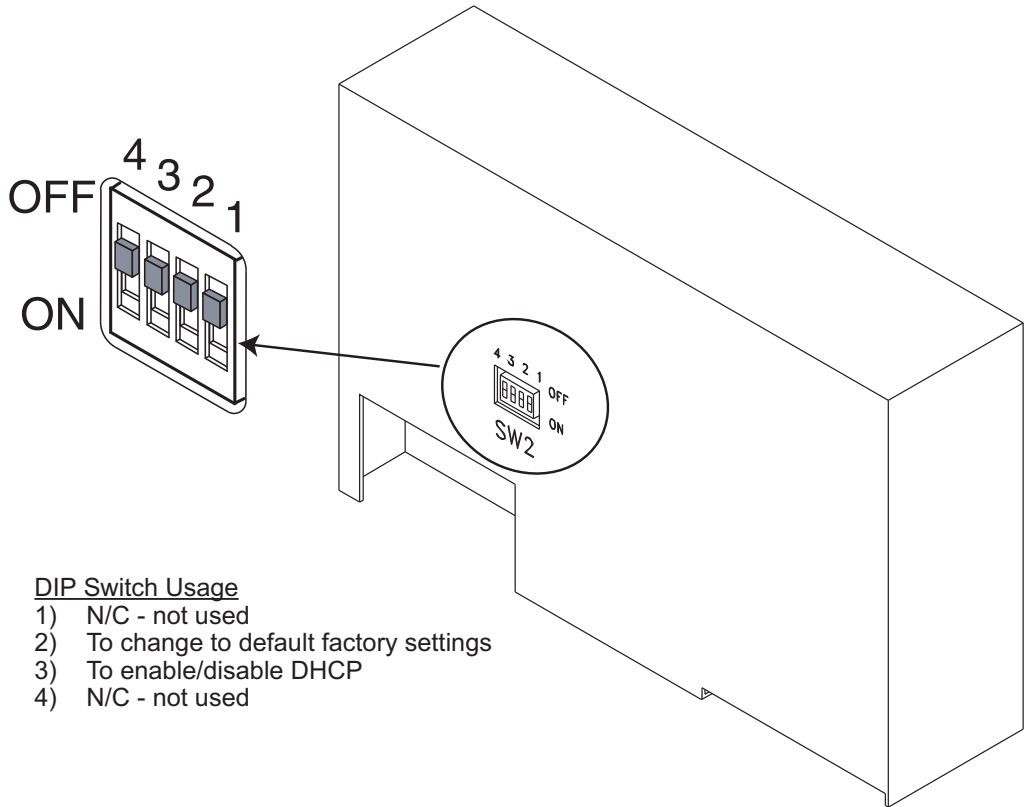

Figure 2.2 Dimensions

2.2 DIP Switches

The iSE is shipped with all DIP switches in "OFF" position.



DIP Switch Usage

- 1) N/C - not used
- 2) To change to default factory settings
- 3) To enable/disable DHCP
- 4) N/C - not used

Figure 2.3 DIP Switch Location

Note

To set the iSE to factory default settings, slide DIP switch #2 to ON position. Power the iSE on and wait about 10 seconds until the iSE fully boots up. Set the DIP switch #2 back to OFF position (it does not matter if the iSE is powered ON or OFF, just make sure that the DIP switch is set to OFF, otherwise, every time the unit is power-cycled the factory settings will take over.

Note

To enable the DHCP, besides using DIP switch #3, set the iSE's IP address to 0.0.0.0. An iSE with IP address of 0.0.0.0 will request an IP address, gateway address, and subnet mask from the DHCP server over the Ethernet

2.3 Parts of the iSE Unit

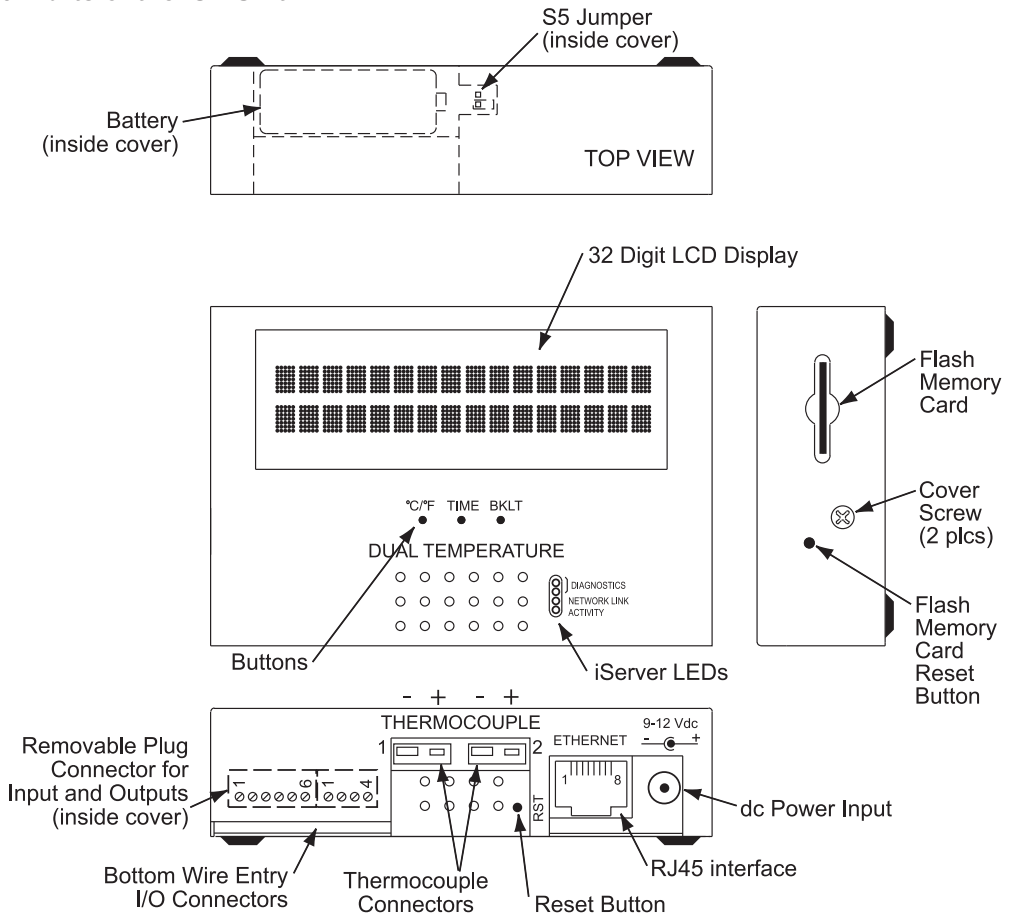

Figure 2.4 Parts of the iSE Unit

Table 2.1 Parts of iSE Unit

ETHERNET	RJ45 interface for 10BASE-T connection.
RESET	Button: Used for power resetting the iSE.
ACTIVITY	LED (Red) Blinking: Indicates network activities (receiving or sending packets).
NET LINK	LED (Green) Solid: Indicates good network link.
DIAGNOSTICS	LED (Yellow) Blinking: Indicates transmitting data from iSE to flash memory card. When DHCP enabled, it remains solid until DHCP IP address is received. LED (Green) Blinking: Indicates receiving data by the iSE from flash memory.
°C/°F	Button: Change display units of measurement from °C to °F
TIME	Button: Change display from DATE and TIME to TEMP
BKLT	Button: Display Back Light

When using the small push buttons, hold the button until “WAIT” is displayed on the LCD and then release.

2.4 Disassembly Instruction

You will need to open the unit for one of the following reasons:

- To wire relay and I/O contact connectors. (Refer to **Section 2.6**).
- To connect or replace the battery. (Refer to **Section 2.7**).
- To change S5 jumper. In the absence of AC power, and if S5 is installed, the LCD Backlight and iSE board will be on and running on the battery power. (Refer to **Section 2.7**).

 Disconnect the power supply before proceeding.

Remove cover by removing 2 screws on each side.

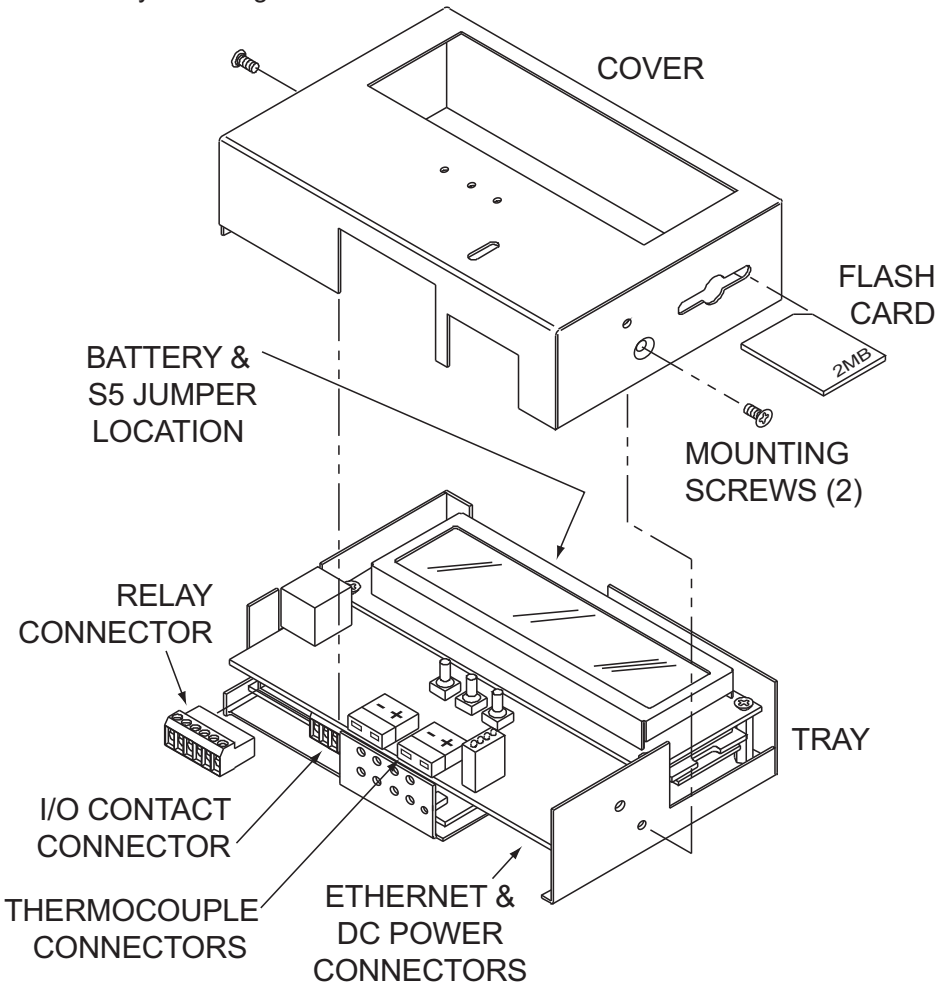

Figure 2.5 Opening the Unit

2.5 Network Communication Interfaces

2.5.1 10Base-T RJ-45 Pinout

The 10BASE-T Ethernet network (RJ45) system is used in the iSE for network connectivity. The 10 Mbps twisted-pair Ethernet system operates over two pairs of wires. One pair is used for receiving data signals and the other pair is used for transmitting data signals. This means that four pins of the eight-pin connector are used.

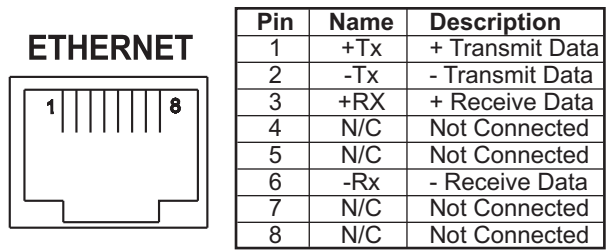

Figure 2.6 RJ45 Pinout

2.5.2 10Base-T Crossover Wiring

When connecting the iSE directly to the computer's network port, the transmit data pins of the computer should be wired to the receive data pins of the iSE, and vice versa. The 10Base-T crossover cable with pin connection assignments are shown below.

Note Use straight through cable for connecting the iSE to an Ethernet hub. The ports on the hub are already crossed.

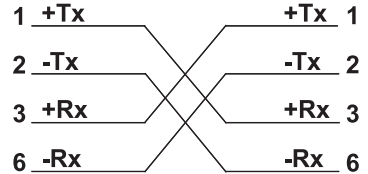

Figure 2.7 10Base-T Crossover Cable Wiring

2.6 Relay and I/O Contact Wiring Connections

To access the Relay and I/O Contact Connectors you must remove the cover, refer to **Section 2.4**.

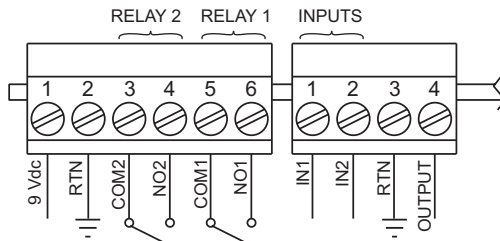

Figure 2.8 Relay and I/O Contact Connections

Note It is recommended that you ground your unit by connecting a wire to the Ground/Return position of the connector or by wrapping a wire around the case's bottom screw. Refer to **Figure 3.1** for location.

2.7 DC Power Input Wiring Connections

A universal ac power adapter with 9 Vdc output is included with your unit. It can be plugged in at the bottom of unit (See **Figure 2.3**).

The unit can also be powered on the Relay Connector Pin 1 and Pin 2 (See **Figure 2.8**). When using these pins to power the iSE, make sure the power adapter is not used.

2.8 Running on Battery Power

To access the Battery and S5 jumper you must remove the cover, refer to **Section 2.4**.

When you first connect the battery, without the AC power adaptor, the unit will be in “Sleep Mode”, in order to save power, and the LCD will display “Flash Standby” (provided that S5 jumper is not installed). When battery is installed, plug the AC adaptor into unit and push the Flash Reset Button (refer to **Figure 2.4**). Unit is now ready to be configured for recording the data. Also, if the AC adaptor is unplugged while the unit is recording, the battery will take over and recording will continue.

Battery and S5 jumper installed: if there is a power outage the iSE board will be fully functional including Ethernet and the LCD backlight “ON”, for approximately 1 hour.

You need to make sure that the *LCD/PWR* field on the Configuration page of the iSE is set to *UPS* (see **Section 4.3.5.F**)

Battery installed and S5 jumper in storage position (Factory Default of S5): if there is a power outage the LCD Backlight and Ethernet will not run, but the unit will be collecting and storing data for approximately 10 days.

Note

If you want to move the unit to a different location, remove the AC adaptor; the installed battery will keep the recording alive until the AC adaptor is plugged back in.

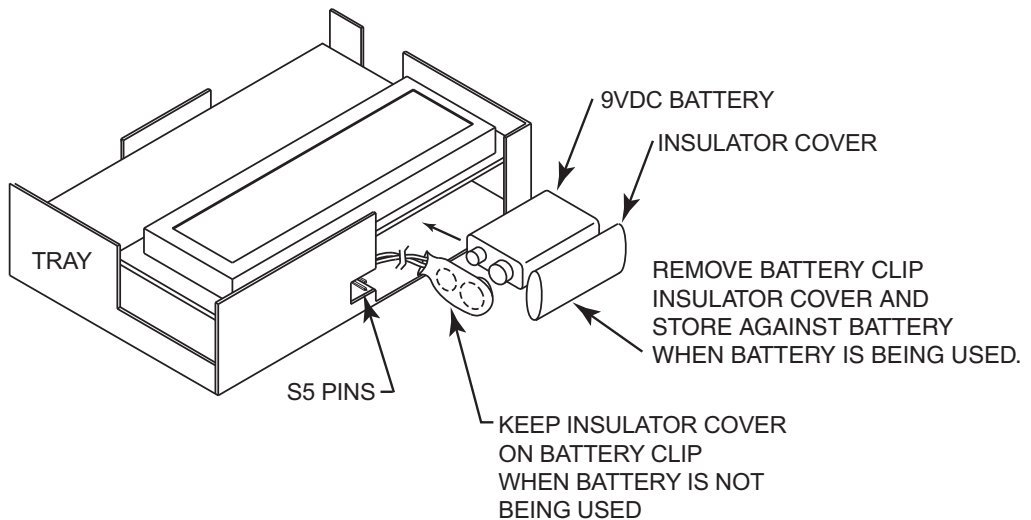

Figure 2.9 Battery and S5 Jumper Location

2.9 Flash Memory Format

A 2 Meg flash memory card is included with your product. This memory card is already formatted; however, the following procedure describes how to format your memory card.

Note

Once the memory card is formatted, all the data that had previously been recorded will be replaced by simulated test data (see **Figure 2.10**).

- 1) Unplug the AC adaptor from the unit.
- 2) Hold down the °C/°F button and connect the AC adaptor back into the unit. Release the °C/°F button.
- 3) You will see the following message appear on the LCD: ***°WAIT* *FLASH***.
- 4) Wait for about 60 seconds and a new message should appear: ***°WAIT* *OKAY***.
- 5) Press the °C/°F button once and this message will appear: **DATA-RECORD-TEST**.
- 6) Press the TIME button and this message will appear: **DATA RECORD TEST - DATA RECORD TEST**.
- 8) Again, press the °C/°F button, the firmware version will appear, followed by ***OKAY***.
- 9) Unplug the AC adaptor and plug it back in. The flash memory card is now formatted. To verify whether the formatting was completed correctly, you should be able to see the following graph on the WEB server's "Chart" page.

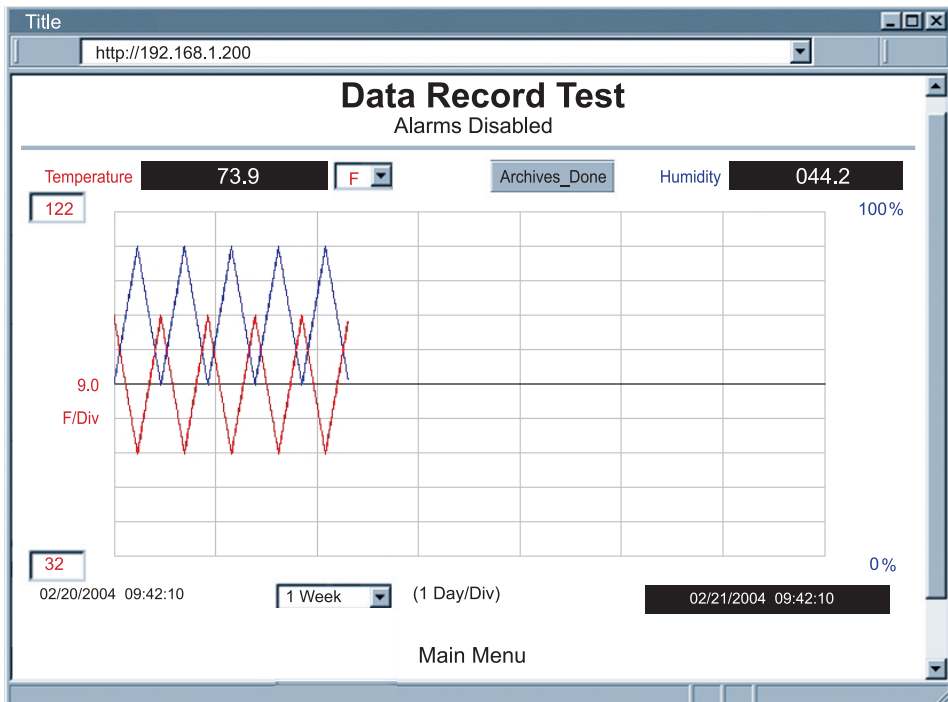

Figure 2.10 Chart of Simulated Data

PART 3 NETWORK CONFIGURATION

3.1 Network Protocols

The iSE can be connected to the network using standard TCP/IP protocols. It also supports ARP, HTTP (WEB server), DHCP, DNS and Telnet protocols.

3.2 Ethernet (MAC) Address

MAC (Media Access Control) address is your computer's unique hardware number. When you're connected to the LAN from your computer, a correspondence table relates your IP address to your computer's physical (MAC) address. The MAC address can be found on a label attached to your device and contains 6 bytes (12 characters) of hexadecimal numbers XX:XX:XX:XX:XX:XX hex

For example: 0A:0C:3D:0B:0A:0B

Note Remove the small label with the default IP address and there will be room to put your IP address. See **Figure 3.1**

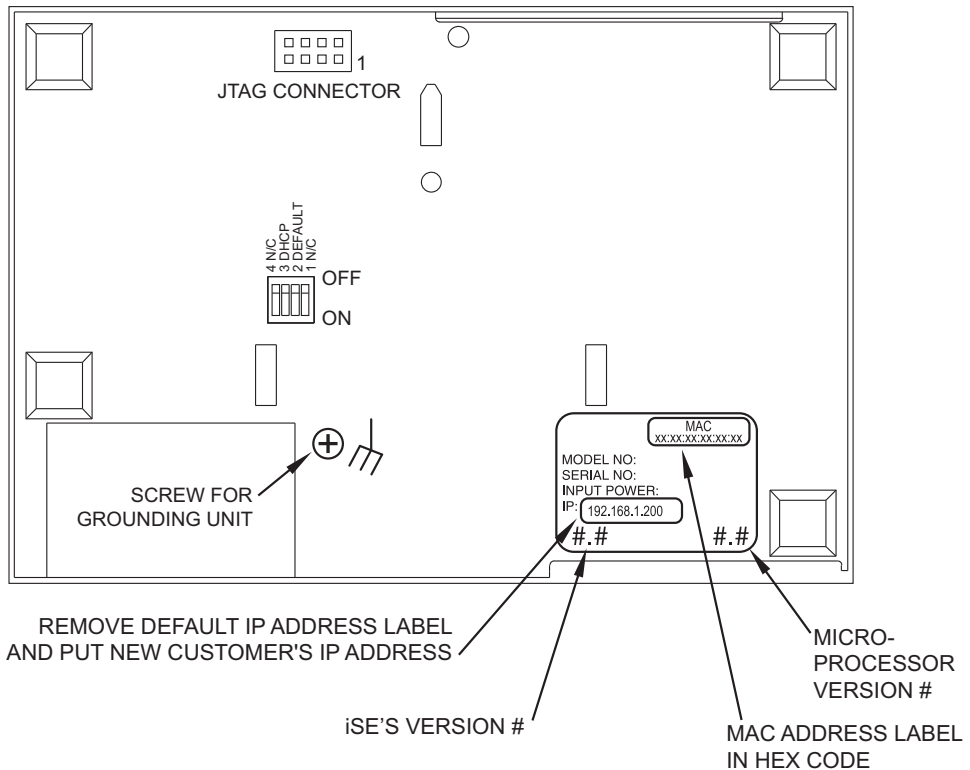

Figure 3.1 Labeling

3.3 DHCP

DHCP, Dynamic Host Configuration Protocol enables individual computers or devices to extract their IP configurations from a server (DHCP server). If the DHCP is enabled on your iSE, as soon as the iSE is connected to the network, there is an exchange of information between DHCP server and the iSE. During this process the IP address, the Gateway address, and the Subnet Mask will be assigned to the iSE by the DHCP server. Note that the DHCP server must be configured correctly to do such assignment.

If fixed or static IP address is desired, the DHCP must be disabled. The iSE is shipped with DHCP disabled (factory default). The DHCP can be enabled by setting the DIP switch # 3 to the “ON” position (refer to **Figure 3.2**).

Note  DIP switch # 3 shown in “ON” position

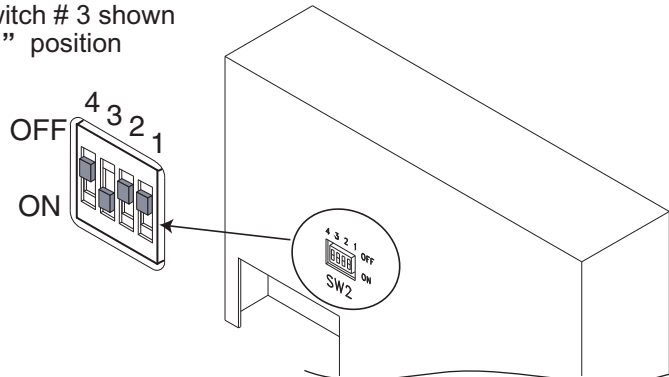



Figure 3.2 DIP Switch on the Bottom Side of iSE

3.4 DNS

DNS, Domain Name System enables individual computers and devices to be recognized over a network based on a specific name instead of an IP address. For example, instead of having to use **http://192.168.1.200** (IP address), you would use only **http://eis03ec** or any eight character name stored as Host Name under the Access Control page in the iSE Home Page. The default DNS name for an iSE is “eis” followed by the last four digits of the MAC address of that particular iSE.

- Note** 
1. It is very important to communicate with the network administrator in order to understand the DHCP and its existing configurations on the host server, before enabling the DHCP on the iSE.
 2. The iSE is shipped with a default static IP address of **192.168.1.200** and Subnet Mask of **255.255.255.0**.
 3. On Novell networks or Windows 2000 Server where the DHCP is an updated function of DNS, this feature may be beneficial since a particular name can be assigned eliminating the need for the IP address, as described in **Section 3.4**.

3.5 IP Address

Every active device connected to the TCP/IP network must have a unique IP address. This IP address is used to build a connection to the iSE. Every computer using TCP/IP should have a unique 32-bit address. It is divided into two portions, the network ID and the host ID. For instance, every computer on the same network uses the same network ID. At the same time, all of them have a different host ID. For more details about the IP address see **Appendix B**.

3.5.1 Default IP Address

The iSE is shipped with a default IP address set to **192.168.1.200** and Subnet Mask of **255.255.255.0**. If you are going to use a Web browser or Telnet program to access the iSE using its default IP address, make sure that the PC from which you're establishing the connection has an IP address that is in the same range as the iSE's IP address (**192.168.1.x**, where **x** can be any number from 1 to 254).

Note Your PC's IP address cannot be the same as the iSE's IP address).

You also need to make sure that your PC's Subnet Mask is **255.255.255.0**. This is a good way to access the iSE over the network and make any configuration changes needed. If **192.168.1.200** is already in use on your network, use an Ethernet crossover cable between your computer and the iSE to change the IP address or any other settings within the iSE.

3.6 Port Number

All TCP connections are defined by the IP address and a port number. A port number is an internal address that provides an interface between an application running on your computer and the network through the TCP/IP protocol.

There are three default TCP socket port numbers assigned to the iSE:

1. Port (socket) number 1000 when using HTTPget program.
2. Port (socket) number 2000 when trying to access the sensor (probe) connected to the port of the iSE to receive data.
3. Port (socket) number 2002 when trying to access the iSE itself for Power Recycling the iSE remotely. This can be done using Windows standard Telnet application.

Power recycling the iSE can also be done through the iSE's Web Server (see **Section 4.2**).

Telnet stands for Telecommunications Network, is a protocol that provides a way for users (or clients) to connect to computers (or servers) on a network, whether in the next building or across the world.

Example: C:\>Telnet 192.168.1.200 2002

You will then get the following screen.

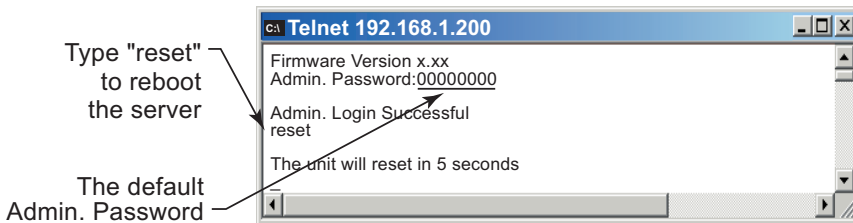

Figure 3.3 Telnet Login into the iSE

You can open a Telnet session using other terminal emulation programs like Tera Term Pro (downloadable from the internet), which is a free software for MS-Windows. It supports VT100 emulation, Telnet connection and serial com port connections.

PART 4 OPERATIONS

This iSE can be used and configured in several ways, depending on user's preference and network setup. It can be configured using a Web browser, like Netscape or Internet Explorer. It can also be configured using the iConnect Configuration Software.

If DHCP and DNS servers are used, the connection is very simple, no need to find the right IP address or watch for network conflicts, these are all done for you by your network DHCP and DNS server. All that is left for you to do, is to enable DHCP on the iSE (see **Section 2.2**) and use a straight network cable to connect the iSE to a hub and power it up.

If DHCP is not the preferred method, you can configure your PC's network connection with an IP address of **192.168.1.x** that is in the same range as the iSE's default IP address (**192.168.1.200**) and connect to the iSE using a cross-over network cable between your PC's network port and the iSE. After you're done with configuring the iSE, you can always set your PC back to its original settings.

On your computer, from the MS-DOS Prompt window type "**ping 192.168.1.200**" and press Enter. If DHCP and DNS servers are used type "**ping eisxxxx**", where **xxxx** are the last four digits of the iSE's MAC address, located on the back of the device. You should get a reply as shown in **Figure 4.1**.

Note You can use the iSE host name (eisxxxx) instead of its IP address only if your DHCP server is configured to communicate with your DNS. Please consult with your IT department for details.

4.0 Testing the Connection

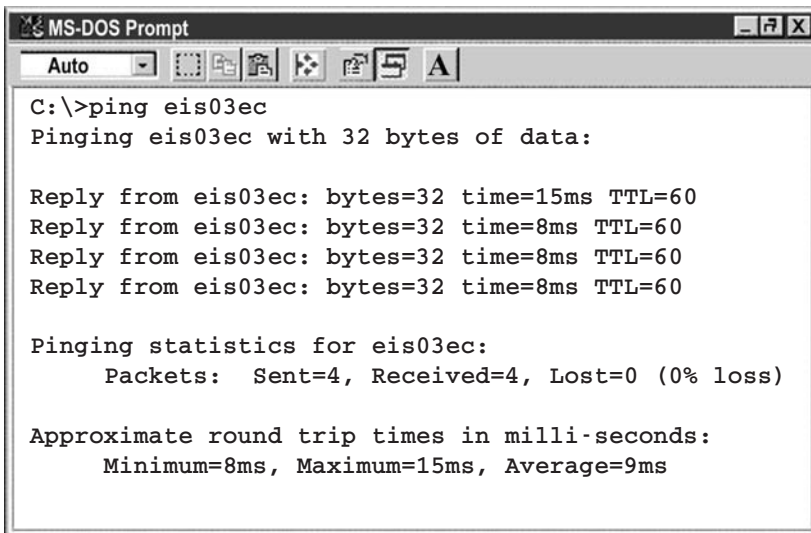

```
MS-DOS Prompt
Auto
C:\>ping eis03ec
Pinging eis03ec with 32 bytes of data:

Reply from eis03ec: bytes=32 time=15ms TTL=60
Reply from eis03ec: bytes=32 time=8ms TTL=60
Reply from eis03ec: bytes=32 time=8ms TTL=60
Reply from eis03ec: bytes=32 time=8ms TTL=60

Pinging statistics for eis03ec:
    Packets: Sent=4, Received=4, Lost=0 (0% loss)

Approximate round trip times in milli-seconds:
    Minimum=8ms, Maximum=15ms, Average=9ms
```

Figure 4.1 Pinging the iSE from MS-DOS Prompt

This proves that the connection is proper and you can get into configuration or run mode using the Telnet or Web browser.

4.1 iConnect Software

The iSE may also be assigned an IP Address by using the iConnect software.

- a) Download the iConnect software from the website listed in this manual.
- b) Install iConnect software on a networked PC. This software is compatible with Windows 95, 98, NT, 2000, and XP.
- c) Use iConnect to assign an IP address to the iSE and access its web pages for configuration. You can also use any standard web browser to access the iSE's web pages. Consult with your IT department for obtaining an IP address.

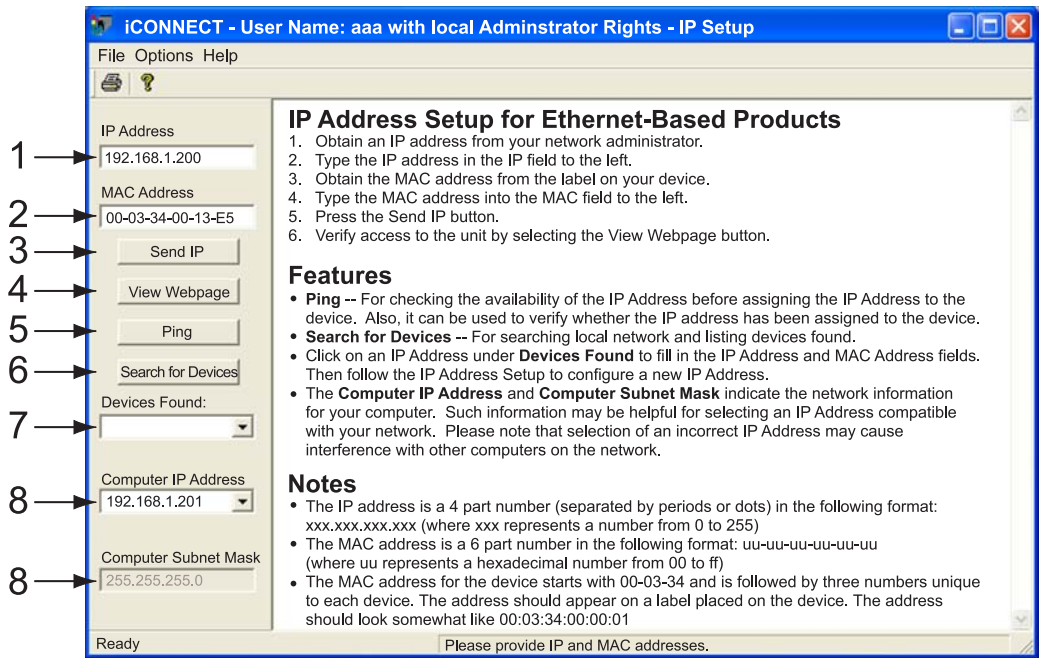

Figure 4.2 Assigning an IP Address using iConnect

- 1) Place the IP address in this box.
- 2) Take the MAC address from the label attached to the bottom of the iSE and place it in this box.
- 3) Click here to send the above IP address to the iSE.
- 4) After the IP address is assigned to the iSE, click here to access it's web pages.
- 5) Click here to Ping the iSE whose IP address is shown in the IP address box.
- 6) Click here to find all the iSE's on your network .
- 7) The IP addresses for the iSE's found by the iConnect will be listed here.
- 8) These fields indicate the IP address and the subnet mask of the PC on which the iConnect is running.

4.1 iConnect Software (continued)

d) To access the iSE for Configuration:

Click on the “View Webpage” button, you will access the iSE’s home page, refer to **Section 4.3** for details.

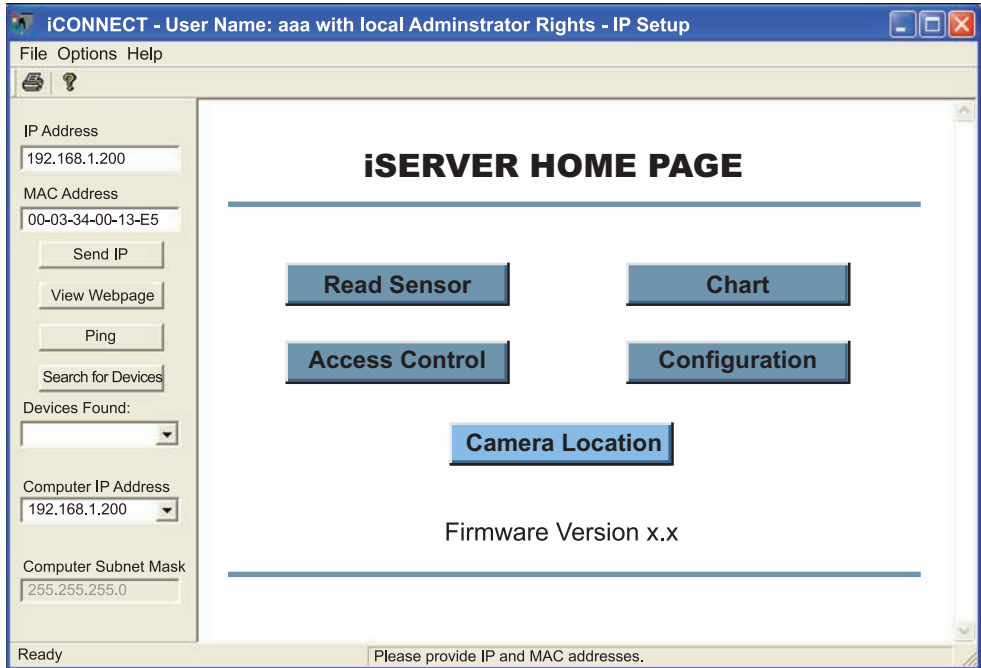

Figure 4.3 Accessing the iSE’s Home Page Menu

4.2 Setting a New IP Address over the Network

Besides using the iConnect software, you may use the iSE's default IP address to access it and assign a new IP address to it.

The iSE is shipped with a default IP address of **192.168.1.200** and Subnet Mask of **255.255.255.0**. You can configure your PC's Network connection with an IP address that is in the same range as the iSE's IP address (**192.168.1.x**) and connect to the iSE using a crossover network cable between your PC and the iSE.

With this completed, you can go to the DOS-Prompt and ping **192.168.1.200**. If you receive responses back (**Figure 4.1**), you can go to a Web browser and type in **<http://192.168.1.200>** and it will take you to the iSE's main web page.

Select **Access Control**, button, you'll be asked for the password. The default LOGIN password is "**12345678**" and the ADMINISTRATOR password is "**00000000**", then you should be on the Access Control page were you can simply type in the desired Static IP address, and click Save.

ACCESS CONTROL

Address <http://192.168.1.200>

ACCESS CONTROL

Login Password:

Admin Password:

Host Name:

MAC Address: 00:03:03:00:21:D9

IP Address:

Gateway Address:

Subnet Mask:

Camera IP:

Camera Label:

Click the following button to activate the new settings.

[Main Menu](#)

Figure 4.4 Access Control

For the IP address to take effect, the iSE needs to be turned OFF/ON. Clicking the "Power Recycle" button will turn the iSE OFF and ON. Pressing the physical button marked "RESET" on the iSE does the same thing.

You can now connect the iSE to an Ethernet hub using a straight through cable, power it up, and follow the ping routine mentioned in the previous section.

4.3 Setup and Operation Using the iSE Web Page

- Start your web browser.
- From the browser you type <http://eisxxxx> using the last four-digits from the MAC address label located on the device if DHCP and DNS are used. If a static IP address is used, then simply type <http://x.x.x.x>, where **x.x.x.x** is the iSE's IP address.
- The Home Page, shown in **Figure 4.5**, will be displayed.

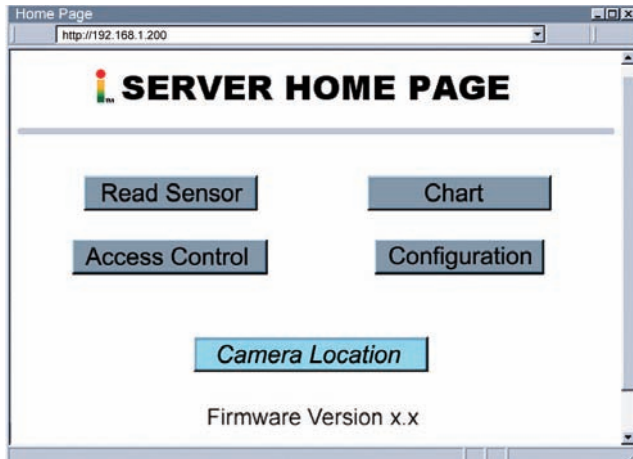

Figure 4.5 iSE Home Page

Note

In order to access certain menu items of the Home Page, users may be prompted for a password, as shown in **Figure 4.6**.



Figure 4.6 LOGIN and ADMINISTRATOR Passwords

There are 2 different access levels:

1. ADMINISTRATOR Password (administrator) allows certain groups and individual users to access and modify "entire" iSE parameters without any restrictions.
The default password is **00000000**. This password can be up to 16 alphanumeric case-sensitive characters.
2. LOGIN Password (operator) allows users to access and modify all of the iSE's parameters, except "Access Control" which requires an Administrator password. The "Read Sensor" does not require a password.
The default password is **12345678**. This password can be up to 16 alphanumeric case-sensitive characters.

4.3.1 Read Sensor

- Click on [Read Sensor](#). In a few seconds the following page (**Figure 4.7**) will appear with all default values of 100.00. Then the actual readings of Temperature will display.
- This page automatically updates the Temperature readings as well as the Differential values.
- Click on Main Menu to return to Home Page.

Note

While accessing the Read Sensor page, If a blank screen appears without any “java application running” or image of a “Java logo”, please verify you have the latest Java Runtime Environment installed and configured according to the following instructions. If you do not have Java Runtime Environment, you may download it from our website or contact the Customer Service Department nearest you.

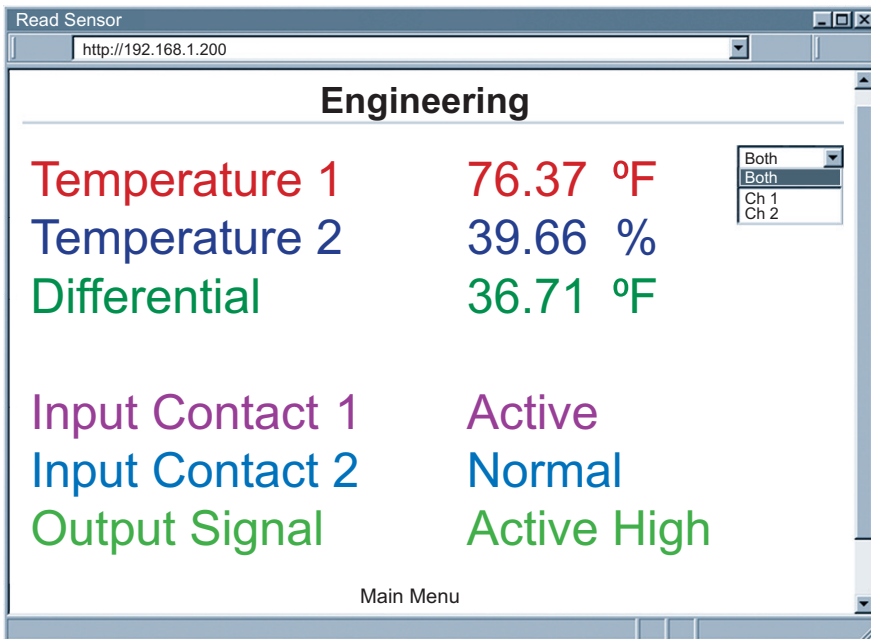

Figure 4.7 Read Sensor

4.3.1.1 Java Runtime Environment 1.4 Setup instructions

1. Go to your computer's Control Panel. Open the Java Plug-in
2. Select the "Cache" Tab
Un-check the "Enable Caching" box
3. Select the "Proxy" Tab. Follow these **Browser Proxy Selection** instructions below. (Generally, un-check the box if accessing an iSE on your local network and check the box for access from your internal network to the internet.)
4. Refresh or restart the webpage.

4.3.1.2 Java Runtime Environment 1.5 (5.0) Setup instructions

1. Go to your computer's Control Panel. Open the Java Plug-in
2. Click on "Settings" & "View Applets" in the "General" tab.
3. Select the "Settings" button on the General Tab
Un-check the "Enable Caching" box. Then close dialog box to show the General Tab again
4. Select the "Network Settings" button on the General Tab.
Proceed to the Browser tab. Follow the **Browser Proxy Selection** instructions below. You should either select the "Use Browser Settings" option or the "Direct Connection" option depending on the network connections between your computer and the iSE product. (Generally, select "Direct Connection" if accessing an iSE on your local network and select "Use Browser Settings" option for access from your internal network to the internet.)
5. Refresh or restart the webpage.

4.3.1.3 Browser Proxy Selection

Accessing iSE units within your internal network

- Usually when the computer and iSE are on an internal network, you will not use Proxy server access.
- You should un-check the "Use Browser Settings" option on the "Proxy" tab.

Accessing iSE units using the internet

- Often the web browser will use Proxy server access to the internet. In such cases, the default Java runtime settings on the "Proxy" tab should suffice. The default setting is the "Use Browser Settings" option.
- If the default proxy setting doesn't work, then you may have a situation where the proxy settings of the web browser are incorrect.

Diagnostics:

If the web page of the iSE appears, then the HTTP Proxy is working fine.

If the data isn't updated on the iSE upon selecting the Read Sensor web page, there may be a problem with access through a winsock proxy server. In such cases your network administrator will need to provide the winsock proxy server and port #s. (If the administrator requires knowledge of the port # required on the iSE, the value is 2003).

These values should be entered into the Socks line on the "Proxy" tab (of the Java Plugin control panel) or into the "connections" tab on the View, Internet Options dialog and make sure that the Proxy tab shows that the "Use Browser Settings" option is not selected (i.e. when you specify proxy connections in the Java Plugin control panel).

Accessing iSE units over Peer-to-Peer network

A simple peer-to-peer network is setup by disconnecting from the main network (as users will often do when trying to do initial setup of the iSE) and then connecting the iSE to another computer using an ethernet hub, an ethernet switch, or a Cross-over cable connection.

Often when using a peer-to-peer network, the Java plugin and the web browser (such as Internet Explorer) have internet connections configured to connect through proxy servers. In such case, you will need to simply assign the final IP address on this peer to peer network and then view the iSE charts after connecting the iSE into the regular network. Otherwise you can disable the Java plug-in's "Use Browser Settings" temporarily and then reconfigure the Java plug-in settings for regular network access after testing the iSE chart access on your peer-to-peer network.

The "Use Browser Settings" should not be selected. And the HTTP and Socks proxy entries should be blank. Also, setup the internet browser so that proxy servers are disabled.

4.3.2 Adjustable Chart

- Click on **Chart**, the following page (**Figure 4.8**) should appear. The Java™ Applet graph displays Temperature values which can be charted across the full span or within any narrow range (such as 20 to 30°C). The time-base can display one minute, one hour, one day, one week, one month or one year.

Note

If a blank screen appears without any “java application running” or image of a “Java logo”, please verify you have the latest Java Runtime Environment installed and configured according to the instructions (refer to **Section 4.3.1.1**). If you do not have Java Runtime Environment, you may download it from our website or contact the Customer Service Department nearest you.

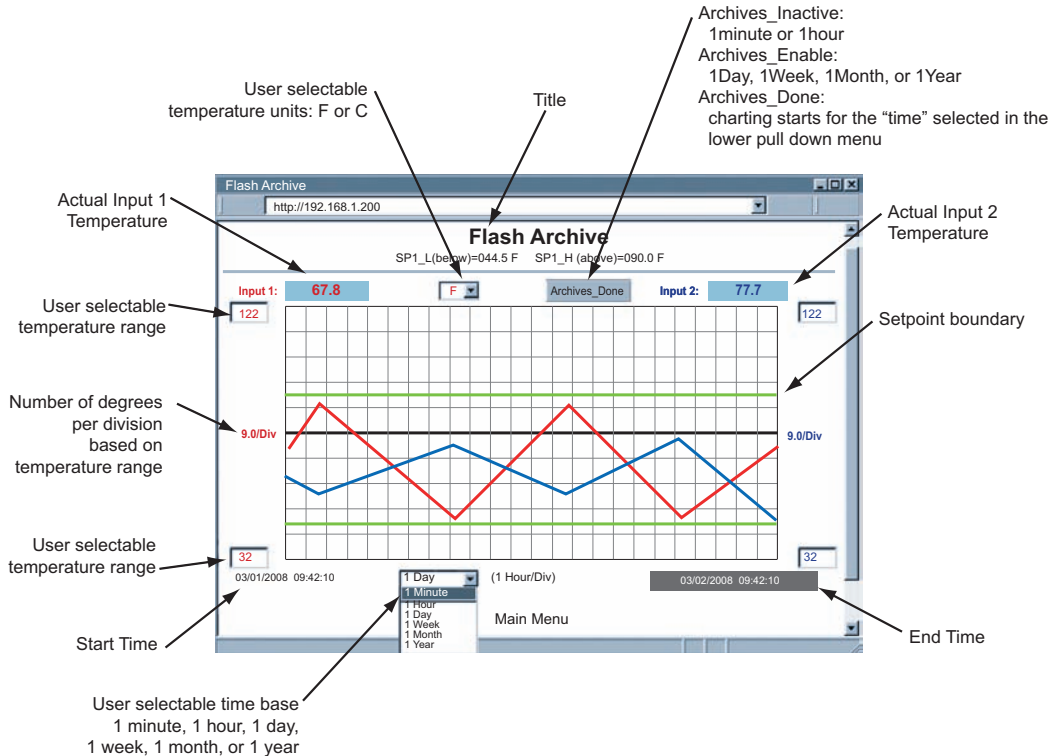

Figure 4.8 Adjustable Chart

Note

To avoid any miscommunications when downloading the stored data from the “Chart” page, it is strongly recommended to let the recording run for a minimum of 3 minutes if the time interval is 10 seconds (from “Configuration” page), and 15 minutes if the time interval is 1 minute.

4.3.3 Retrieving Data from Flash

To retrieve and graph the data that is stored in the Flash Memory, you have two options:

OPTION 1:

You can use the iSE's WEB interface to chart the data stored in the flash memory.

1. Click on the "Chart" button located on the Server Home Page, see **Figure 4.5**.
2. Select a time interval of Day, Week, Month or Year (Minute and Hour are not selectable for data retrieval).
3. As soon as the time interval is selected the "Archives_Inactive" button will change to "Archives_Enable".
4. Click on "Archives_Enable" button to graph the stored data.

OPTION 2:

Download the iSE Download Utility **iFlash** software from the website listed in this manual and install it on your networked PC. This software is compatible with Windows 95, 98, NT, 2000, and XP operating systems. After the installation is completed, you can run the program to obtain the screen shown in **Figure 4.9**.

Note

To avoid any miscommunications when downloading the stored data using the iFlash program, it is strongly recommended to let the recording run for a minimum of 3 minutes if the time interval is 10 seconds (from "Configuration" page), and 15 minutes if the time interval is 1 minute.

IP Address: Place the IP address of the iSE from which you want to download data, in this window.

Output Filename: Assign the path and the file name in which the downloaded data will be placed, in this window.

Model: Select the iSE-TH option.

Latest Data for: This option allows you to download data for the last day, week, or month. By selecting "Full" you can download the whole data.

Output Format: This option gives the data in either Excel format (check the box) or Text format (uncheck the box).

Header Data: You can choose what to appear for the header of the data file either in Excel or Text format.

Scale: This will give you the temperature in either Fahrenheit or Celsius.

Access Log: The completion of data download will be reported in this window. You can start downloading by clicking on the "Start Download" button.

The screenshot shows the iFlash Download Utility window. The IP Address is 192 . 168 . 1 . 200. The Output Filename is C:\Data.xls. The MODEL is ISE-TC. The Latest Data for is Full. The Output Format is Excel Format. The Header Data includes IP Address, Date and Time, and Column Names. The Scale is Fahrenheit. The Pres. units are mBar/hPa. The Start Download, Cancel, and Exit buttons are visible at the bottom.

Figure 4.9 iFlash Download Utility

4.3.4 Access Control

This section describes the "Access Control" page of the iSE's Web interface. This page allows the users to set up the network and security parameters of the iSE.

At the initial entrance to the "Access Control" page you will be prompted for the LOGIN Password (see **Figure 4.6**) prior to an ADMINISTRATOR Password.

Note The DHCP can be enabled by setting the dip switch number 3 to ON position.

Note Changes made in the iSE's Access Control page can be saved permanently by pressing the Save button and power recycling the iSE.

← If you change a field and press Save, this message will appear

Figure 4.10 Access Control

Login Password: This allows users to access and modify all of the iSE Home Page menu items, except "Access Control", which requires an Administrator password. The default Login password is **12345678**. This password can be up to 16 alpha-numeric case-sensitive characters. If there is no Login Password assigned (blank box) the iSE will not require a password to access and modify iSE Home page menu items.

Admin (administrator) Password: This allows users to access and modify the "Access Control" page. The default password is **00000000**. This password can be up to 16 alpha-numeric case-sensitive characters. If there is no Administrator Password assigned (blank box) the iSE will not require password to access and modify "Access Control" page.

Host Name: Refer to **Section 3.4, DNS**.

MAC Address: This is also called Hardware address or Ethernet address, which is assigned to the iSE at production. The MAC (Media Access Control) address is the iSE's unique hardware number and is not changeable.

IP Address: The IP (Internet Protocol) address is a 32-bit number that identifies each sender or receiver of information that is sent in packets across the Ethernet or the Internet. The iSE's default IP address is **192.168.1.200**. The iSE's IP address should be changed to fit user's networking environment. Consult with your IT department for obtaining an IP address.

Gateway Address: A gateway is a network point that acts as an entrance to another network. A gateway is often associated with a router, which knows where to direct a given packet of data that arrives at the gateway. If the iSE is sending packets to another network node that is not on the same network on which the iSE is connected, a gateway address needs to be given to the iSE. The gateway address should be the IP address of the router connected to the same LAN to which the iSE is connected. The iSE's default gateway address is **0.0.0.0**. Consult with your IT department for obtaining a gateway address.

Subnet Mask: It is a 32-bit number that is used to determine which part of the IP address is the network portion and which part is the host portion. The iSE's default subnet mask is **255.255.255.0**. Consult with your IT department for obtaining a subnet mask.

Camera IP: If there is a networked camera on the LAN, it can be accessed from the iSE's Home Page by adding the Camera's IP address in this field.

4.3.4 Access Control (continued)

Camera Label: This is the text field to name the camera button on the iSE Home Page, the default is "Camera Location".

Power Recycle: Clicking this button will reset the power on the iSE.

4.3.5 Configuration

Setting up the Flash Memory Card can be done in the Configuration page. From the Home Page Menu click on Configuration to get to the page (see **Figure 4.11**).

General Description of the Configuration page: There are two general sections "Flash Card Memory" and "Server". Flash Card Memory consists of the following titles: Real Time Clock (RTC), Title, Alarm Setup, and Flash Recording. Server consists of Terminal Server and Remote Access.

Title and Flash Recording selections can be edited *once* by selecting "*Activation - Start Recording*" and after that, no modification will take place unless recording is stopped (the reason for this is to be compliant with the data logging rules). The remaining parameters can be changed during recording as explained below.

There are several scenarios depending on the state of the Flash Card and the Real Time Clock (RTC):

#1) RTC is not set and Flash Card is empty.

All the fields must be updated exactly according to the indicated format, "*Adjust RTC Only*" check box must be left unchecked, "*Activation*" selection must set to "*Start Recording*" and click the "*Update*" button. Having done this, it is recommended to select "*Configuration*" from "*Activation*" drop down window, click the "*Update*" button, set the "*Activation*" to "*Status/RTC/Alarm*" and click the "*Update*" button one more time to review/verify that the setup took place as it was intended.

#2) RTC is set, and recording is in progress.

The only possible setups are to update "*Date*" and "*Time*" of the Real Time Clock along with checking "*Adjust RTC Only*" box. Also, alarms can be updated provided that "*Activation*" is set to "*Status/RTC/Alarm*". Otherwise, the recording has to be stopped by selecting "*Stop Recording*" of the "*Activation*" drop down window prior to modifying the Flash Card setup. An alternative way to stop recording is to push Standby Button (refer to **Figure 2.3**) of the unit.

#3) RTC is set, recording is stopped, and Flash Card is not empty.

This means that a pre-recorded Flash Card is installed, and by activating the chart the archived data can be viewed (Refer to **Figure 4.8**). The chart has the following selections: 1 Minute, 1 Day, 1 Week, 1 Month, 1 Year

In other words, they are the last specified selection e.g. 1 Day means the last day of the recorded data. Having done the selection, the "*Archives_Enable*" button must be clicked, which will then change to "*Archives_Done*" and the data will be retrieved accordingly. Also, the corresponding Start and End dates will reflect the respective time duration e.g. refer to **Figure 4.8** which is the last 1 Day, the dates are:

02/20/2004 09:42:10 to 02/21/2004 09:42:10.

#4) RTC is not set and the Flash Card is not empty.

This is similar to item 3) above except that at the power-up the installed Flash Card was not empty. Or, the Flash Card Reset Button (refer to **Figure 2.3**) was pushed.

CONFIGURATION

http://192.168.1.50

CONFIGURATION

No.	Sensor Name	Reading Command	Remote End Char	Display Units	Remote Format	Offset
1	Temperature 1	SRTF	0D	F	T0000.0	0.0
2	Temperature 2	SRHF	0D	F	T0000.0	0.0
3	Differential	SRDF	0D	F	D0000.0	0.0
4	Input Contact 1	SRT2	0D			
5	Input Contact 2	SRH2	0D			

Click on Sensor No. on left to modify Sensor Parameters.

Real Time Clock

Date: mm/dd/yyyy Time: hh:mm:ss

Adjust RTC Only: Time Stamp:
Secured Applet:

2-MegaBytes Flash Card 22 Kbytes Used Space

Flash Card Pre-Recorded AC Power On and Low Battery

Alarm Setup

Input 1 Alarm: Input 2 Alarm:

Input 1 Status: Input 2 Status:

SP1_L: nnn.n SP2_L: nnn.n

SP1_H: nnn.n SP2_H: nnn.n

Flash Recording Settings

Title: Degree Unit: LCD/PWR:

Type: Interval: Activation:

Start Date: mm/dd/yyyy Time: hh:mm:ss

End Date: mm/dd/yyyy Time: hh:mm:ss

Input Contact Closure

Contact Input 1: Contact Input 2: Active Contact Output:

Output Type:

Terminal Server

TCP/UDP: Server Type: Forward CR Number of Connections Port:

Remote Access (Tunneling)

Remote IP Address: Remote Port: Remote Access:

Main Menu

Figure 4.11 Configuration

4.3.5 Configuration (continued)

Below are the definitions of terms used in the Configuration page.

A) Configuration/Device Setup

Clicking on the No. **1**, **2**, **3**, **4** or **5** allows you to modify the Sensor Parameters (see **Section 4.3.6** for more details).

B) Real Time Clock

RTC Date and Time: The formats are *mm/dd/yyyy* and *hh:mm:ss*. The exact formats are required otherwise an error message will appear in the Title box. Note: time is military time/24 hour based.

Adjust RTC Only: If checked, the clock will be updated and nothing else, provided that “*Activation*” is set to “*Status/RTC/Alarm*”. To verify the clock, set the “*Activation*” to “*Configuration*”, click *Update* button, then set “*Activation*” to “*Status/RTC/Alarm*” and click *Update* button one more time.

Time Stamp: If checked, the Temperature values will be stamped with time and date using Port 1000 (HTTPget program must be used, see **Section 4.5.1**).

Secured Applet: If checked, the LOGIN password is required to open “*Read Sensor*” and “*Chart*” pages.

C) Flash Card Size: Reports the Flash Card density and if it is already recorded, how many locations are filled.

0-Megabytes: Flash Card is not installed or a bad Flash Card

2-Megabytes, 4-Megabytes, 8-Megabytes: available sizes of Flash Cards.

D) Flash Card Message: Describes RTC setup, listed in the previous 4 scenarios.

Flash Card Module Malfunctional

Open Sensor

Flash Card Standby

Flash Card Recording Stopped

Flash Card Pre-Recorded

Flash Card Recording Complete

Flash Card Recording On

Wait Reading Flash

Flash Card Module Not Initialized

Recording Initialized

Flash Card Corrupt Initialization

If the battery is not connected or the voltage is low, the statement “*Low Battery*” will be added to the above statements. You may also see a statement “*Archive Busy*” if another client is busy receiving archive data. In this case, refrain from activating the applet, instead keep clicking the *Update* button and make sure “*Activation*” is set to “*Status/RTC/Alarm*” until the “*Archive Busy*” statement is no longer displayed.

E) Alarm Setup: There are two alarms which can be assigned to Temperature 1 Temperature 2 (one alarm to each variable). Selection of Input 1 or Input 2 and Setpoint High (SP_H) or Setpoint Low (SP_L).

Temperature 1 and **Temperature 2:** *Disable, Low, High, High/Low*

Disable: Alarm is disabled (no alarm function)

Low: Alarm is enabled only with Low setpoint

High: Alarm is enabled only with High setpoint

High/Low: Alarm is enabled only with High and Low setpoints

Example: If High/Low is selected, the temperature will be monitored against these two High and Low values. If temperature goes above High value (082.5), Relay 1 will be energized, and if temperature goes below Low value (032.5) Relay 1 will be energized.

Input 1 Status: *Unlatch, Latch, Clear Latch, Chart SP*

Input 2 Status: *Unlatch, Latch, Clear Latch, Chart SP*

Unlatch: The relay in the iSE will be turned on (closed) when the Temperature 1 and/or Temperature 2 values fall outside of Setpoint range. When the Temperature 1 and/or Temperature 2 values are back within the range, the relay will be turned off (opened).

Latch: The relay in the iSE will be turned on (closed) when the Temperature 1 and/or Temperature 2 values fall outside of Setpoint range and will remain on until the user turns it off.

Clear Latch: This option will clear the latch, meaning the activated alarm will be disabled.

Chart SP: Selecting this option will add the setpoints to the "Chart".

SP1_L, SP1_H and SP2_L, SP2_H: Editable box for Setpoint values. The format is *nnn.n*, it must be followed exactly otherwise the modification will not take place for any modified item in the Alarm Setup.

F) Flash Recording

Title: Editable field with up to 16 characters long. The given name will display as a title on the "Chart" and "Read Sensor" pages either for the real-time data or the stored data.

Degree Unit: The unit of temperature either in degree *Fahrenheit* or degree *Centigrade*.

LCD/PWR: The selections are "ON", "OFF", and "UPS". Selecting "OFF" will cause the LCD to turn off during a power outage, provided the battery is connected. The current consumption is about 1.5 mA or 3 mA depending on "OFF" or "ON" selection respectively. If recording is "ON", depending on the recording interval, the LCD will be updated every 10 seconds or 1 minute. Therefore, when the LCD is set to "ON", it could take some time before the LCD is turned on. If recording is not "ON", the LCD will be updated every 10 seconds.

Selecting "UPS" puts the iSE into full operational mode when it's running on the battery (S5 jumper needs to be installed, see **Section 2.4** and **2.7**). This means that in case of power outage, sensing, recording, LCD display, and network communication capabilities of the iSE will all operate on the battery. Due to heavy power consumption the battery will not last more than an hour.

Type: The selections are: "*Limited*", "*Wrap*", or "*Nonwrap*".

Limited: You must define the *Start Date* and *Time*, and *End Date* and *Time* in which you need the recording to be done.

Wrap: You only need to define the *Start Date* and *Time*. The iSE will record data until the Flash is full, then the iSE will continue to record and overwrite the existing data.

Nonwrap: You only need to define the *Start Date* and *Time*. The iSE will record data until the Flash is full, then the iSE will stop recording.

Interval: The recording interval at which the temperature is being stored into the Flash Card. The selections are "*10 seconds*" and "*1 minute*".

Note

To avoid any miscommunications when downloading the stored data using the iFlash program or from the "Chart" page, it is strongly recommended to let the recording run for a minimum of 3 minutes if the time interval is 10 seconds (from the "Configuration" page), and 15 minutes if the time interval is 1 minute.

Activation: The selections are "*Status/RTC/Alarm*", "*Start Recording*", "*Configuration*", "*Stop Recording*" and "*Reset*". Refer to previous scenarios #1 and #2 at the beginning of this **Section 4.3.5** for more details.

4.3.5 Configuration (continued)

Status/RTC/Alarm: Select “*Configuration*” and “*Status/RTC/Alarm*”, each followed by clicking the Update button to retrieve the latest recording settings. By selecting “*Status/RTC/Alarm*” only, followed by clicking the “Update” button the iSE will report back all the settings, but the “Recording” settings.

Start Recording: Select to initiate a recording.

Configuration: Select to retrieve the latest recording settings, followed by “*Status/RTC/Alarm*” option.

Stop Recording: Select to stop an ongoing recording.

Reset: Selecting this option will reset the flash memory, LCD, and recording sections to a fresh start. It is suggested to select “*Reset*” followed by clicking the “Update” button if you experience recording problems.

Start Date, Time: Starting date and time for recording. The format is *mm/dd/yyyy* and *hh:mm:ss*, it must be followed exactly. Entry is required for all Types of Flash Recording.

End Date, Time: Ending date and time for recording. The format is *mm/dd/yyyy* and *hh:mm:ss*, it must be followed exactly. Entry is required for Limited Type of Flash Recording only.

NOTE 1: While the recording is in progress, the “Recording ON” will be displayed on the LCD.

NOTE 2: Downloading data and recording can not be done at the same time. While downloading data, the writing process to the flash memory will be internally disabled while the data is being read from the memory flash. For small amounts of data to be retrieved (1 Day or 1 Week), this is not a significant interruption in the recording data. However, for large amounts of data (1 Month or 1 Year) it may take 4 to 8 minutes to download the data. In “*Archives_Enabled*” mode, charting remains static, while data download is taking place.

NOTE 3: The number of temperature values that can be recorded depends on the memory flash capacity (2 Mbytes, 4 Mbytes or 8 Mbytes) and recording interval time, e.g: 1 minute interval for 4 Mbytes is 1,081,212 minutes or 750 days. If the flash is busy sending data to the applet to chart the archive, the iSE will refuse to initiate a call to provide archived data to the second applet until it has finished with the first one.

NOTE 4: In case of a power outage and no battery backup, if the unit is recording, the recording will stop but the data that was stored will be saved. Please note, the last recorded data (30 minutes to an hour, depending on time interval) could be lost, due to the fact that the data is initially stored to the buffer before it is transferred to the Flash Memory and loss of power will erase the data in the buffer.

NOTE 5: After you “*Start Recording*” the flash recording followed by clicking the “*Update*” button, if you then need to make any changes in the Flash Recording section you must either select “*Stop Recording*” followed by clicking the “*Update*” button or push the reset button on the side of the iSE and reconfigure the Flash Recording section.

NOTE 6: If you stop the recording prematurely, when you download the data, you will lose the last 256 bytes of the data that was left in the buffer and was not transferred into the flash card. Therefore, we strongly suggest downloading the data while the recording is still on and then stop the recording if desired.

4.3.5 Configuration (continued)

G) Input Contact Closure

Contact 1: *Disable, Normally Open, Normally Close*

Contact 2: *Disable, Normally Open, Normally Close*

Disabled: Contact is dysfunctional.

Normally Open: Contact is open. If the contact is closed, there will be an Output High or Low, depending on which output is selected. Read Sensor page will display: *Normal*.

Normally Close: Contact is closed. If the contact is open, there will be an Output High or Low, depending on which output is selected. Read Sensor page will display: *Active*.

Active Contact Output: *Active High, Active Low*. The Output can be High or Low when the status on the input contact is changed.

Output Type: *Unlatch, Latch, Clear Latch*

H) Terminal Server

TCP/UDP*: The iSE supports *TCP* and *UDP* protocols (default is *TCP*). If *UDP* is selected, it can be configured either for Broadcast *UDP* or Directed *UDP*. In case of Broadcast *UDP*, the iSE will transmit the data to every node on the network. This can be accomplished if the Remote IP Address is set to *255.255.255.255*.

The Broadcast *UDP* is a practical solution when one iSE needs to communicate with multiple nodes over the network. In the case of directed *UDP*, the iSE will transmit the data to a specific node on the network. This can be accomplished if the Remote IP Address is set to the IP address of that specific node.

Server Type: *Continuous* mode sends the temperature to the Ethernet, every two seconds. It is mainly used to send readings to a remote display.

Command mode (default) needs a command to query the iSE to send the response back to querying device.

Forward CR: Forward *CR* can be *enabled* and *disabled*. If *enabled* the iSE will forward a *<CR>* along with the data to a network host.

Number of Connections: The range is from *0* to *5*. If *0* is selected, the Terminal Server feature is disabled. This means that no network connection can be made to the sensor connected to the iSE. If *1* is selected, only one network connection can be made to the iSE's. Any number more than *1* would allow that number of network hosts to read from the iSE simultaneously (default is *5*).

Port: Port *2000* is the default *TCP* port for the iSE's port to which the sensors are connected. Ports *1000* (used for *HTTPget*, refer to **Section 4.5**), *2002*, *2003*, and *2004* are reserved for internal use.

Note

Terminal Server usually describes a device that exchanges data between Ethernet/TCP/IP networks and RS-232/RS-485 systems. With this iSE, the data is obtained digitally from the sensor (irrelevant to RS-232 or RS-485 interface) and can be accessed from anywhere on the network.

A computer program, such as Mail Notifier, OPC Server, iLog, iFlash or *HTTPget* can send *TCP* requests and obtain readings using the Terminal Server feature.

4.3.5 Configuration (continued)

l) Remote Access

Remote IP Address: iSE can establish a connection to a remote device (e.g. an iLD Remote Display with an Ethernet iSE embedded board) with this IP.

Remote Port: (default 2000) the remote port number for the connection. Ports 1000 (used for HTTPget, refer to **Section 4.5**), 2002, 2003, and 2004 are reserved for internal use.

Remote Access:** Remote Access can be enabled and disabled. If enabled, the iSE can send its data to a remote node on the same network (the “Remote IP address” and “Remote Port” must be entered).



*TCP/UDP: when UDP mode is selected, Remote Access should be disabled and Remote IP and Port are the UDP remote listening IP and Port. If the Remote IP is set to 255.255.255.255, the UDP packet becomes a broadcasting packet which will allow any device listening to the Remote port to receive the packet.

**If Remote Access is enabled, Terminal Server is automatically disabled.

4.3.6 Sensor Parameters

- In the first column of Configuration page (**Figure 4.11**), click on No. **1** to view and modify the Sensor Parameters page for **Temperature 1**.

The screenshot shows a web browser window titled "Sensor Parameters" with the URL "http://192.168.1.200". The main heading is "SENSOR PARAMETERS No. 1". The configuration fields are: Sensor Name: "Temperature 1"; TC Type: "K"; Sampling Rate: "4"; Remote End Char 0x: "0D"; Remote Display Format: "T0000.0 Cnnnn.n"; Offset: "0.0" °C; Cold Junction: "Disable". Below the fields are "Update", "Reset", and "Cancel" buttons. A note at the bottom says "Click on Update button of the Configuration page to finalize updates." and a link for "Main Menu" is provided.

Figure 4.12 Sensor Parameters - Temperature

Note

You may type any ASCII characters in the first two boxes, but you must delete the leading spaces.

- In the first column of Configuration page (**Figure 4.11**), click on No. **4** to view and modify the Sensor Parameters page for **Input Contact 1**.

The screenshot shows a web browser window titled "Sensor Parameters" with the URL "http://192.168.1.200". The main heading is "SENSOR PARAMETERS No. 4". The configuration fields are: Sensor Name: "Input Contact 1"; Remote End Char 0x: "0D". Below the fields are "Update", "Reset", and "Cancel" buttons. A note at the bottom says "Click on Update button of the Configuration page to finalize updates." and a link for "Main Menu" is provided.

Figure 4.13 Sensor Parameters - Input Contact

4.3.6 Sensor Parameters (continued)

Below are some definitions of terms used in the Sensor Parameter pages.

Sensor Name: a text field shown on the “Read Sensor” page.

TC Type: a list of thermocouple types to select from *J, K, T, E, R, S, B, C, N, and L (J Din)*. (See **Figure 12**).

Sampling Rate: the number of readings per second. The options are: 2, 4, 8, and 12; if the higher sampling rate is selected, you’ll have a lower accuracy. (See **Figure 12**).

Remote End Char: The default value is 0D (Hex representation of <CR>). This means that the iServer sends <CR> after each temperature value. This will be done in Continuous mode.

This is how the data will appear on the host with 0D assigned:

**TA71.34F
TA72.48F
TD-1.19F**

If the end character, for instance, is 20 (Hex representation of space), the data will then appear as:

TA71.34FTA72.48FTD-1.19F

If nothing is set for the “Remote End Char” field, the iServer will then forward the data to the LAN with no characters followed.

Remote Display Format: This determines the data format sent by the iServer to a remote network node (e.g. iLD Display)

Example: If Channel 1 shows temperature of **71.34°F**, the **TA71.34F** will be seen on the remote display. If no format is specified (blank), there is no reading sent out. If temperature is **75.7** and **T00.0F** is used in temperature setting, the remote site will show **T75.7F**.

This format setup was originally made for the iLD Display, which has four or six LEDs. For six LEDs, **T00.00F** format, and for four LEDs, **00.0F** format are appropriate.

Offset: Since the sensing probe is solid state electronics, there is no need for calibration. If it’s determined that the readings are slightly off, the user can manually assign numerical values to adjust the readings for temperature values. The unit must be in degree C. The Offset value can either be a positive or negative number

Cold Junction: The options are *Disable* and *Comp_1* for sensor 1 and *Comp_2* for sensor 2. Selecting *Comp_1* or *Comp_2* will allow you to adjust (calibrate) that sensor in reference to 0°C environment. Cold Junction Compensation is done for type K thermocouple for both sensors before the product is shipped. If a different type of thermocouple is used, we strongly recommend to perform Cold Junction Compensation on that sensor.

Input 2: The options are *Enable* and *Disable* for the second thermocouple sensor only. If it is disabled the thermocouple #2 and the “Differential” value will be shown as “N/A” on the “Read Sensor” and “Chart” pages.

Note

If the second thermocouple channel is not used, it is strongly recommended to disable “Input 2”, for faster operation.

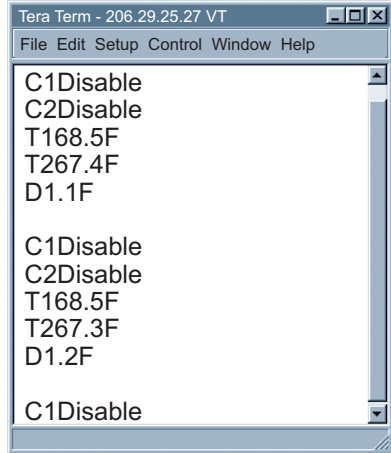

Figure 4.14 Remote End Char

4.4 Telnet Setup

Set the *Number of Connections* to 1-5 other than 0, using telnet simulation program connect to iSE. In continuous mode, the telnet terminal will receive continuous messages from the iSE. In command mode, the command can be sent to query the iSE and get a response back. Refer to **Figure 3.3**

Send remote reset: Telnet port 2002 will bring a terminal for admin password. After typing the password and following with the end character, the message Admin. Login Successful will be showed on the terminal. Now type "reset" following with return character to reset the iSE. If no character is received within 20 seconds, the terminal will be closed automatically.



Note

Initiating the archive chart while Telnet is active will halt Telnet until the archive chart is done.

4.5 HTTPget Program

The HTTPget software is used to send a single HTTP or TCP request to an iSE product. In contrast, the telnet or Hyperterminal programs allow a continuous connection with multiple requests to be sent to the iSE product.

Generally HTTPget is used for simply programming an IP address to the iSE or for quickly obtaining a reading of from a device.

The iSE product must be configured from the configuration web page so that the "Server Type" value is set to "Command" (This is positioned under the heading of Terminal Server). Also the *Number of Connections* may need to be set to "0" to enable Port 1000 (Port 1000 is for access in a non-standard terminal mode).

To use Port 2000 access (where "2000" is the value stored in "Port"), the *Number of Connections* should be set to "2" for general usage. The value of 2 can later be changed to a value from 1 to 5 depending on needs for secure access or fault tolerance.

Whenever Terminal Server service (using Port 2000 by default) is required, the *Number of Connections* must be set to a value from 1 to 5. The Terminal Server mode is the recommended mode for the most reliable connection when operating with NEWPORT software or with other programs supporting TCPIP communications.

The Port 1000 access can be used with NEWPORT software and may be needed with some iSE products when you need to view readings from the web page while simultaneously collecting data through TCPIP communications.

4.5.1 HTTPget using Port 1000

You can setup and read the information from the iSE by using the HTTPget program. The following program can be used to read data from the embedded server firmware by using TCP port **1000**. The command string is sent to this TCP port, then the response can be read back from the same socket.

The HTTPget.exe file is used to setup and read information from the iSE. This file will be automatically installed when you install the MailNotifier software available on our website and CD.

Notes on using **HTTPget** :

The HTTPget.exe program is installed to the windows directory (usually c:\winnt or c:\windows) when installing the Mail Notifier software.

1. Open up a command window (or have a DOS window)
 - a) Click on start menu
 - b) Click on "Run"
 - c) In the dialog box that appears, type "cmd" or "command" and click on "OK" button.
 - d) A command window should now appear.
2. If you now type "HTTPget" and press the "enter" key, the program options should be displayed.
3. Next run HTTPget with the options displayed as shown in the following text

4.5.1 HTTPget using Port 1000 (continued)

httpget -r -S “*SRTC\r” 192.168.1.200:2000

where:

-r -S are parameters needed for the command string

***SRTC** is the command as the following:

*SRTC	Read the temperature in C (Channel 1)
*SRTF	Read the temperature in F (Channel 1)
*SRHC	Read temperature in C (Channel 2)
*SRHF	Read temperature in F (Channel 2)
*SRDC	Read the differential in C
*SRDF	Read the differential in F
*SRA1	Read temperature setpoints (Channel 1)
*SRA2	Read temperature setpoints (Channel 2)
*SRB	Read the temperature in C, (both Channel 1 and Channel 2)
*SRYS	Indicate AC or DC power and battery status
*SRYRST	Reset Power on iSE
*SR_XD1	Exclude alarm 1 (disable alarm 1 function)
*SR_XD2	Exclude alarm 2 (disable alarm 2 function)
*SR_XC1	Reset relay 1 latch condition
*SR_XC2	Reset relay 2 latch condition
*SR_XE1	Include alarm 1 (enable alarm 1 function)
*SR_XE2	Include alarm 2 (enable alarm 2 function)
*SR_XP1	Close relay 1 for < 200 mSec
*SR_XP2	Close relay 2 for < 200 mSec
*SR_XH1	Close relay 1
*SR_XH2	Close relay 2
*SR_XL1	Open relay 1
*SR_XL2	Open relay 2
*SRT2	Status of Contact 1 (Disable, Normal, Active)
*SRH2	Status of Contact 2 (Disable, Normal, Active)
*SRD2	Status of the Output associated with the Contacts (Active High, Active Low)

\r is the carriage return termination character

192.168.1.200 is an IP address

2000 is a socket port number

Response:

076.6 (in Deg.F 35)

4.5.2 HTTPget and ARP to setup Device IP Address



Use the iConnect software, which may be downloaded from our website, to do these IP changes whenever possible.

Use ARP first to assign the mac address to a static IP address in computer arp table by this command:

```
arp -s 192.168.1.200 00-03-34-00-06-b6
```

Then use the following command to assign new IP to the device:

```
httpget -r -S "00000000" 192.168.1.200:1
```

where:

"00000000" is admin. password. If the password is wrong, the unit will ignore the new IP. If the new IP is taken, you will get the message " New IP is Assigned" after the HTTPget command. The device will reset automatically. (TX and RX led is on for 2 seconds).

"192.168.1.200" is an example of an IP adress. It is replaced with an IP address suitable for your network

"00-03-34-00-06-b6" is replaced with your iSE product MAC address.

4.6 ARP Protocol

ARP is the Internet layer protocol responsible for matching or obtaining the MAC (hardware) address that corresponds to a particular IP address. The ARP command allows the user to view the current contents of the ARP cache of the local computer (residing on the same network). Microsoft includes the ARP.EXE utility for viewing and modifying the ARP cache with its Windows products. The following ARP commands can be used to view cache entries:

- **arp -a** Use this command to view all ARP cache entries.
- **arp -a** plus **IP address** Use this command to view ARP cache entries associated with one particular interface on a network with multiple adapters.
- **arp -g** Same as arp -a.
- **arp -N** Use this command to display ARP entries for specific network interface.
- **arp -s** plus **IP address** plus **Physical address** Use this command to manually add a permanent static entry to the ARP cache.
- **arp -d** Use this command to manually delete a static entry.

Note

Ping the destination computer using IP address first before using the arp -a command.

The following window shows [examples](#) of arp commands and responses.

- Your computer has an IP address of **192.168.1.118**
- The destination computer has an IP address of **192.168.1.96**

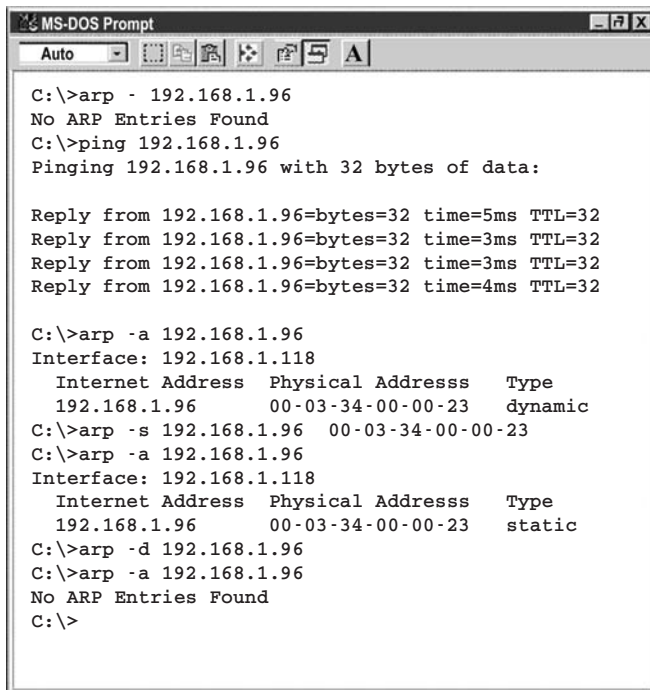

```
MS-DOS Prompt
Auto
C:\>arp - 192.168.1.96
No ARP Entries Found
C:\>ping 192.168.1.96
Pinging 192.168.1.96 with 32 bytes of data:

Reply from 192.168.1.96=bytes=32 time=5ms TTL=32
Reply from 192.168.1.96=bytes=32 time=3ms TTL=32
Reply from 192.168.1.96=bytes=32 time=3ms TTL=32
Reply from 192.168.1.96=bytes=32 time=4ms TTL=32

C:\>arp -a 192.168.1.96
Interface: 192.168.1.118
   Internet Address   Physical Addresss   Type
   192.168.1.96      00-03-34-00-00-23   dynamic
C:\>arp -s 192.168.1.96 00-03-34-00-00-23
C:\>arp -a 192.168.1.96
Interface: 192.168.1.118
   Internet Address   Physical Addresss   Type
   192.168.1.96      00-03-34-00-00-23   static
C:\>arp -d 192.168.1.96
C:\>arp -a 192.168.1.96
No ARP Entries Found
C:\>
```

Figure 4.15 ARP Commands and Responses

4.7 iLog Software

This is an Excel application software that can log temperature 1, temperature 2 and the differential temperature from the iSE over the local network (Ethernet) or the internet.

- Download the iLog software from the website listed in this manual.
- Install iLog software on a networked PC. This software is compatible with Windows 95, 98, NT, 2000, and XP.
- For complete information of how to use the iLog software, click on the HELP button.
- There is a list of Error Messages in **Appendix E**.

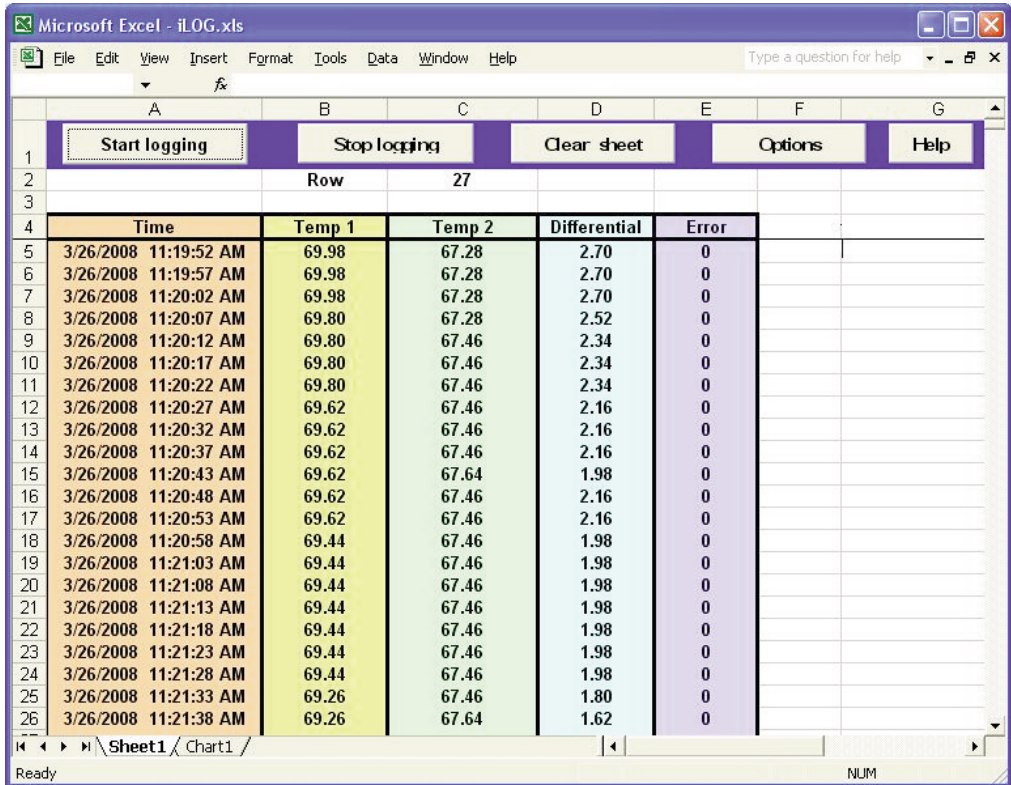

The screenshot shows a Microsoft Excel spreadsheet titled "iLOG.xls". The interface includes a menu bar (File, Edit, View, Insert, Format, Tools, Data, Window, Help) and a toolbar. The spreadsheet has a header row (row 2) with buttons for "Start logging", "Stop logging", "Clear sheet", "Options", and "Help". Row 3 shows "Row 27". The data table starts at row 4 with the following columns: Time, Temp 1, Temp 2, Differential, and Error. The data is recorded from 11:19:52 AM to 11:21:38 AM on 3/26/2008.

Time	Temp 1	Temp 2	Differential	Error
3/26/2008 11:19:52 AM	69.98	67.28	2.70	0
3/26/2008 11:19:57 AM	69.98	67.28	2.70	0
3/26/2008 11:20:02 AM	69.98	67.28	2.70	0
3/26/2008 11:20:07 AM	69.80	67.28	2.52	0
3/26/2008 11:20:12 AM	69.80	67.46	2.34	0
3/26/2008 11:20:17 AM	69.80	67.46	2.34	0
3/26/2008 11:20:22 AM	69.80	67.46	2.34	0
3/26/2008 11:20:27 AM	69.62	67.46	2.16	0
3/26/2008 11:20:32 AM	69.62	67.46	2.16	0
3/26/2008 11:20:37 AM	69.62	67.46	2.16	0
3/26/2008 11:20:43 AM	69.62	67.64	1.98	0
3/26/2008 11:20:48 AM	69.62	67.46	2.16	0
3/26/2008 11:20:53 AM	69.62	67.46	2.16	0
3/26/2008 11:20:58 AM	69.44	67.46	1.98	0
3/26/2008 11:21:03 AM	69.44	67.46	1.98	0
3/26/2008 11:21:08 AM	69.44	67.46	1.98	0
3/26/2008 11:21:13 AM	69.44	67.46	1.98	0
3/26/2008 11:21:18 AM	69.44	67.46	1.98	0
3/26/2008 11:21:23 AM	69.44	67.46	1.98	0
3/26/2008 11:21:28 AM	69.44	67.46	1.98	0
3/26/2008 11:21:33 AM	69.26	67.46	1.80	0
3/26/2008 11:21:38 AM	69.26	67.64	1.62	0

Figure 4.16 iLog Software Logging Data

4.8 Mail Notifier Software

For complete information of how to use the Mail Notifier software, click on the Help menu of the main window.

The Mail Notifier software generates email notifications for alarm conditions. Users can be notified automatically of alarm conditions monitored via internet connections throughout the world. By use of the email forwarding of alarm conditions, alarm conditions can be monitored on a network isolated from the internet and forwarded to connections on the Internet.

The Mail Notifier utility operates under Windows 98, NT 4.0, 2000, and XP in conjunction with existing email that supports the MAPI messaging interface. If MS Outlook has been loaded, the MAPI support should be available.

4.8.1 Installation

The Mail Notifier must be loaded on a computer running Microsoft Windows (versions specified earlier) using an email program that provides MAPI access. Network access must be available between this computer and the iSE. Network access must also be available from this computer to the appropriate email server and from the email server to the recipient's email server.

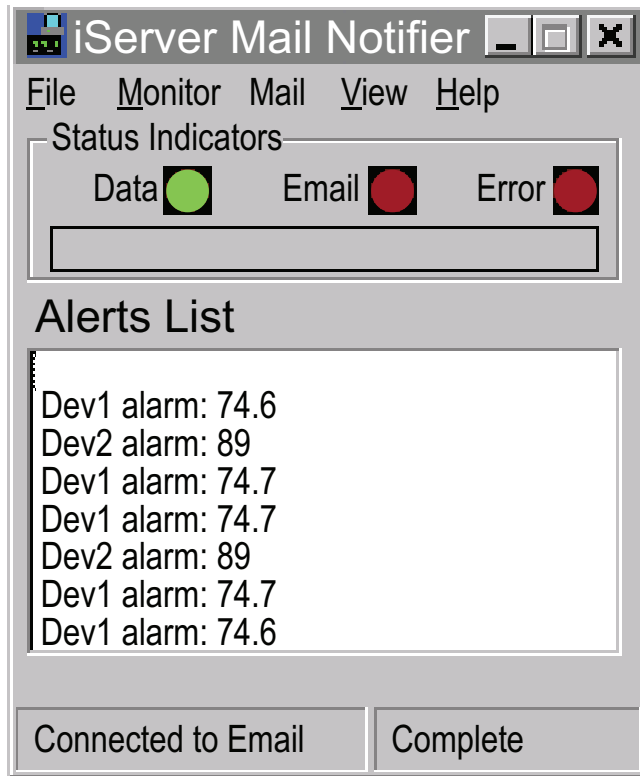

Figure 4.17 iSE Mail Notifier Main Window

4.8.2 Program Options Setup and Configuration

Complete program setup requires:

- Entering a recipient for the email
- Specifying connection details to MAPI services.
- Defining alarms for devices, and selecting how and when the email will be active.

The screenshot shows a Windows-style dialog box titled "Options" with a close button (X) in the top right corner. The dialog has five tabs: "Send To", "Email Setup", "Content", "Startup", and "General". The "Email Setup" tab is selected. Inside the dialog, there is a "Mail Server" section. Within this section, there is a "MAPI" sub-section. The "MAPI" section contains the following elements: a "Name/Profile" text box, a "Password" text box, a "Use Login Box" checkbox which is checked, and "Email Address" radio buttons for "MS Outlook" and "Outlook 2002". At the bottom of the dialog are four buttons: "Help", "OK", "Cancel", and "Apply".

Figure 4.18 iSE Mail Notifier Profile Setup

Email Address Setup

The email addresses must be entered using individual addresses or alias. Select "Options" from the "View" menu and enter the email addresses on the "Send To" screen. This will be the list of email addresses to which alarm notifications will be sent.

Email Setup

The Mail Notifier is compatible with original MS Outlook™ and Outlook™ 2002 to 2005.

The Mail Notifier will attempt to automatically identify whether the Outlook is a newer version. A red bar appears under the Mail Notifier splash window to confirm that the detection of the 2002 or newer version is acceptable. With the newer versions, no additional steps should be taken to enable the connection between the Mail Notifier and the Email server.



MS Outlook tends to require that the users respond to a "login box" in order for email access to be activated for Mail Notifier. Some other email clients may allow for Mail Notifier to gain access without user login, as may be desired for a system recovering from a power outage. See the Help files for more information.

4.8.3 Device Setting and Configuration

Device setup requires:

- Server IP Address: for iSE device (for example **192.168.1.200**).
- Socket Number: (1000 or 2000 depending on iSE settings).
- Bus Address/Device ID: interface address (1 to 199). Enter "0" for RS232 interface or for iSE.
- Reading Cmd: normally set to SRFT to obtain reading from the devices. If you want to change this setting, refer to list of commands in **Section 4.5**.
- Alarm Type: (High/Low, High value, or Low value).
- Info Message: text can be entered to describe the alarm condition.
- Email Interval: the time interval in which the email is sent.
- Monitor Interval: the interval or time resolution in which readings will be obtained from the device.
- Alarm Hold Time: the time delay of each subsequential alarm notification to be sent.

The screenshot shows the 'Alarm Editor' dialog box with the following fields and values:

Device Info (1 of 2)	
Server IP Address	192.168.1.200
Socket Number	1000
Bus Address/Device ID	1
Description	
Src ID	Dev 2
Reading Cmd	SRTF

Buttons: OK, Cancel, Help, Add, Del

Only Monitor Access to iServer device

Alarm Configuration			
Alarm Type	Alarm High	Info Message	
Alarm High	73	Email Interval	0.05 hrs.
Alarm Low	0	Monitor Interval	0.5 min.
		Alarm Hold Time	0.0 min.

Figure 4.19 iSE Mail Notifier Device Setting

PART 5 SPECIFICATIONS

SENSOR SPECIFICATIONS

Thermocouple Input

Temperature Range: refer to Thermocouple Chart

Temperature Accuracy: refer to Thermocouple Chart

Resolution: 1°/0.1°

Temperature Stability: 0.08°C/°C

Thermocouple Cold End Tracking: 0.05°C/°C

Thermocouple Lead Resistance: 100 ohm max.

Thermocouple Type (ITS 90): J, K, T, E, R, S, B, C, N, L

	Input Type	Range	Accuracy
J	Iron - Constantan	-210 to 760°C / -346 to 1400°F	0.4°C / 0.7°F
K	CHROMEGA®-ALOMEGA®	-270 to -160°C / -160 to 1372°C -454 to -256°F / -256 to 2502°F	1.0°C / 0.4°C 1.8°F / 0.7°F
T	Copper - Constantan	-270 to -190°C / -190 to 400°C -454 to -310°F / -310 to 752°F	1.0°C / 0.4°C 1.8°F / 0.7°F
E	CHROMEGA®-Constantan	-270 to -220°C / -220 to 1000°C -454 to -364°F / -364 to 1832°F	1.0°C / 0.4°C 1.8°F / 0.7°F
R	Pt / 13%Rh-Pt	-50 to 40°C / 40 to 1768°C -58 to 104°F / 104 to 3214°F	1.0°C / 0.5°C 1.8°F / 0.9°F
S	Pt / 10%Rh-Pt	-50 to 100°C / 100 to 1768°C -58 to 212°F / 212 to 3214°F	1.0°C / 0.5°C 1.8°F / 0.9°F
B	30%Rh-Pt / 6%Rh-Pt	100 to 640°C / 640 to 1820°C 212 to 1184°F / 1184 to 3308°F	1.0°C / 0.5°C 1.8°F / 0.9°F
C	5%Re-W / 26%Re-W	0 to 2320°C / 32 to 4208°F	0.4°C / 0.7°F
N	Nicrosil - Nisil	-250 to -100°C / -100 to 1300°C -418 to -148°F / -148 to 2372°F	1.0°C / 0.4°C 1.8°F / 0.7°F
L	J DIN	-200 to 900°C / -328 to 1652°F	0.4°C / 0.7°F

iSE SPECIFICATIONS

INTERFACES

Ethernet:	10Base-T (RJ45)
Sensor:	Digital 4-wire (Mini-DIN 6)
Supported Protocols:	TCP/IP, UDP/IP, ARP, ICMP, DHCP, DNS, HTTP, and Telnet
LED Indicators:	Network Activity, Network Link, and Diagnostics
LCD Display:	32 digits, 4.8 x 9.7mm (0.19 x 0.38")
Processor:	Enhanced 8051, 22 MHz
Memory:	512 Kbytes Flash, 16 Kbytes SRAM
Memory Data Flash Card:	2 Mbytes or 2 months of data storage at 10 second logging intervals, or 1 year at 1 minute logging intervals. Atmel# AT45DCB002
Optional Flash Cards:	4 Mbyte (2 years at 1 minute intervals), 8 Mbyte (4 years at 1 minute intervals)
Relay Outputs:	Two relays 1.5A @ 30Vdc
Alarm I/O's:	2 Contact Inputs, 1 Open Collector Output 150mA @ 30 Vdc
Management:	Device configuration and monitoring through embedded WEB server
Embedded WEB Server:	Serves WEB pages containing real-time data and live updated charts within definable time intervals.

POWER

Power Input:	9 to 12 Vdc
Consumption:	2.5 W max.
Safety Qualified ac Power Adapter (included):	
Nominal Output:	9 Vdc @ 0.5 A
Input:	100 to 240 Vac, 50/60Hz
Battery:	9 Vdc, alkaline approximately 650 mA hours

ENVIRONMENTAL

Operating Temperature: 0 to 60°C (32 to 140°F)

PACKAGING

Material:	SS 304 case with wall mount bracket
Dimensions:	88.1H x 130.2W x 35.8D mm (3.47 x 5.13 x 1.41") including wall mount bracket
Weight:	444.5g (0.98 lbs.)

GENERAL

Agency Approvals: FCC-B, CE

Software: Packages available are--iConnect, iLog, iFlash, and Mail Notifier; compatible with all Windows operating systems.

**PART 6
FACTORY PRESET VALUES**

PRESET PARAMETERS	FACTORY DEFAULTS
Network Interface:	
IP Address	192.168.1.200
Gateway Address	0.0.0.0
Subnet Mask	255.255.255.0
Device Host Name	eis and the last 4 digits from the MAC address
Login Password	12345678
Admin Password	00000000
DHCP	Disabled
Terminal Server:	
Server Type	Command
Number of Connections	5
Port #	2000
Forward CR	Enable
Remote Access (Tunneling):	
Remote Access	Disable
Remote Port	2000
Remote IP Address	0.0.0.0
LCD Backlight	On

PART 7

APPROVALS INFORMATION

7.1 CE APPROVAL

 This product conforms to the EMC directive 89/336/EEC amended by 93/68/EEC, and with the European Low Voltage Directive 72/23/EEC.

Electrical Safety EN61010-1:2001

Safety requirements for electrical equipment for measurement, control and laboratory.

Basic Insulation

Pollution Degree 2

Dielectric withstand Test per 1 min

- Input Power to Ethernet Output: 1500Vac
- Input Power to Relays: 1500Vac
- Ethernet Output to Relays: 1500Vac

Measurement Category I

Category I are measurements performed on circuits not directly connected to the Mains Supply (power). Unit measures Temperature.

Transients Overvoltage Surge (1.2/50uS Pulse)

- Input Power: 500V Transients Overvoltage
- Ethernet: 1500V Transients Overvoltage

Note: *The ac/dc power adaptor must have Safety Qualified Agency Approvals for CE with Double Insulation rating.*

The ac/dc power adaptor is 9Vdc.

The minimum output current rating is 500mA.

EMC EN61000-6-1:2001 (Immunity) and EN61000-6-3:2001 (Emmissions)

Immunity requirements for residential, commercial and light-industrial environments

- EMC Emissions Table 1, Class B
- EMC Immunity Table 1: Enclosure
Table 2: Signal Lines Ports
Table 3: Dc input/Dc output Ports

EMC EN61326:1997 + and A1:1998 + A2:2001

Immunity and Emissions requirements for electrical equipment for measurement, control and laboratory.

- EMC Emissions Table 4, Class B of EN61326
- EMC Immunity Table 1 of EN61326

Note: *I/O lines / sensor cables require shielded cables and these cables must be located on conductive cable trays or in conduits.*



Refer to the EMC and Safety installation considerations (Guidelines) of this manual for additional information.

7.2 FCC

This device complies with Part 15, Subpart B, Class B of the FCC rules.

User of this manual should be familiar with following definitions:

ARP (Address Resolution Protocol) is a protocol for mapping an Internet Protocol address (IP address) to a physical machine address that is recognized in the local network. For example, the IP address in use today is an address that is 32-bits long. In an Ethernet local area network, however, addresses for attached devices are 48-bits long. (The physical machine address is also known as a Media Access Control or MAC address.) A table, usually called the ARP cache, is used to maintain a correlation between each MAC address and its corresponding IP address. ARP provides the protocol rules for making this correlation and providing address conversion in both directions.

Ethernet is a network protocol defined by the IEEE 802.3 standard. Ethernet-based networks use MAC Address rather than IP Address to exchange data between computers. By using ARP and adding TCP/IP support, Ethernet devices may be connected as part of the Internet. An Ethernet LAN typically uses coaxial cable or special grades of twisted pair wires. The most commonly installed Ethernet systems are called 10BASE-T and provide transmission speeds up to 10 Mbps. Devices are connected to the cable and compete for access using a Carrier Sense Multiple Access with Collision Detection (CSMA/CD) protocol.

IP (Internet Protocol) is the method or protocol by which data is sent from one computer to another on the Internet.

IP address (Internet Protocol address) is a 32-bit number that identifies each sender or receiver of information that is sent in packets across the Internet.

IP Netmask is a 32-bit pattern of bits used to determine which part of the IP address is the network portion and which part is the host portion.

MAC (Media Access Control) Address is your computer's unique hardware number. When you're connected to the Internet from your computer, a correspondence table relates your IP address to your computer's physical (MAC) address on the LAN.

Ping is a utility that tests the network connectivity. It is used to determine if the host is capable of exchanging information with another host.

Port number/Socket number is a way to identify a specific process to which an Internet or other network message is to be forwarded when it arrives at a server. It is a predefined address that serves as a route from the application to the Transport layer or from the Transport layer to the application of the TCP/IP system.

Sockets are a method for communication between a client program and a server program in a network and defined as "the endpoint in a connection." Information transferred across the Internet primarily occurs between sockets.

TCP/IP (Transmission Control Protocol/Internet Protocol) is the basic communication language or protocol of the Internet. When you are set up with direct access to the Internet, your computer is provided with a copy of the TCP/IP program just as every other computer that you may send messages to or get information from also has a copy of TCP/IP. TCP/IP often is used as a general term to indicate generic access to the Internet.

UDP/IP (User Datagram Protocol/Internet Protocol) is the TCP/IP standard protocol that allows an application program on one machine to send a datagram to an application program on another. The UDP can be either in Broadcast or Directed form. The Broadcast UDP transmits data to every node on the same network. The Directed UDP transmits data to one node only.

Appendix B

IP Address

An IP address is a unique 32-bit address assigned to a computer and includes:

- A network ID number identifying a network.
- A host ID number identifying a computer on the network.

All IP addresses have been divided into three smaller groups (classes) A, B and C

- **Class A** addresses have 8-bits of network ID and 24-bits of host ID. They can support a large number of hosts, approximately $2^{24} = 16,777,216$ computers per network.

The IP addresses range in binary from 00000001.xxxxxxxx.xxxxxxxx.xxxxxxxx
to 01111111.xxxxxxxx.xxxxxxxx.xxxxxxxx

The IP addresses range in decimal from 1.x.x.x to 127.x.x.x

Class A network ID's support a very large number of hosts.

- **Class B** addresses have 16-bits of network ID and 16-bits of host ID. They can support approximately $2^{16} = 65,536$ computers per network.

The IP addresses range in binary from 10000000 00000000.xxxxxxxx.xxxxxxxx
to 10111111 11111111.xxxxxxxx.xxxxxxxx

The IP addresses range in decimal from 128.0.x.x TO 191.255.xxx.xxx

Class B network ID's support a medium number of hosts.

- **Class C** addresses have 24-bits of network ID and 8-bits of host ID. They can support approximately $2^8 = 256$ computers per network.

The IP addresses range in binary from 11000000.00000000.00000000.xxxxxxxx
to 11011111.11111111.11111111.xxxxxxxx

The IP addresses range in decimal from 192.0.0.xxx to 223.255.255.xxx

Class C network ID's support a small number of hosts.



The rest of the addresses are divided into two classes, D and E.

Class D networks are not assigned to the host. They are used for multicasting. The address range from 224.x.x.x to 239.x.x.x

Class E networks are experimental or reserved addresses.

The address range from 240.x.x.x to 247.x.x.x

Appendix C

IP Netmask

IP Netmask or Subnet Mask is a 32-bit pattern of ones and zeros used to determine network portion of an IP address from the host portion of the IP address. Subnet mask is a network ID that is created by borrowing bits from host portion of IP address and using them as part of a network ID. The table below shows a default subnet mask for address Classes A, B, and C. Each bit that is set to "1" in the subnet mask corresponds to the bit in the IP address that is to be used as the network ID. Each bit that is set to "0" in the subnet mask corresponds to a bit in the IP address that is to be used as the host ID.

Address Class	Mask Binary Value	Mask Decimal Value or Dotted Notation
Class A	11111111 00000000 00000000 00000000	255.0.0.0
Class B	11111111 11111111 00000000 00000000	255.255.0.0
Class C	11111111 11111111 11111111 00000000	255.255.255.0

If your network requires more network ID's, you can extend the default subnet mask to include additional bits from the host ID. This allows for additional network ID's within the network. The table below shows some examples of subnet masks and bits moved from the hosts ID to create a new subnet.

Mask Dotted Notation	Mask Binary	Mask Bits
Class A		
255.0.0.0 (Default)	11111111 00000000 00000000 00000000	0
255.192.0.0	11111111 11000000 00000000 00000000	2
255.224.0.0	11111111 11100000 00000000 00000000	3
255.240.0.0	11111111 11110000 00000000 00000000	4
255.248.0.0	11111111 11111000 00000000 00000000	5
255.252.0.0	11111111 11111100 00000000 00000000	6
255.254.0.0	11111111 11111110 00000000 00000000	7
255.255.0.0	11111111 11111111 00000000 00000000	8
255.255.128.0	11111111 11111111 10000000 00000000	9
255.255.192.0.0	11111111 11111111 11000000 00000000	10
.....
255.255.255.252	11111111 11111111 11111111 11111100	22
Class B		
255.255.0.0 (Default)	11111111 11111111 00000000 00000000	0
255.255.192.0	11111111 11111111 11000000 00000000	2
.....
255.255.255.252	11111111 11111111 11111111 11111100	14
Class C		
255.255.255.0 (Default)	11111111 11111111 11111111 00000000	0
255.255.255.192	11111111 11111111 11111111 11000000	2
.....
255.255.255.254	11111111 11111111 11111111 11111100	6

To determine the number of valid hosts ID's remaining after subnetting, use the following equation: $2^n - 2$, where n is the number of octet digits left after the subnet mask.

Appendix D

ASCII Chart

ASCII Char	Dec	Hex	Binary No Parity	ASCII Char	Dec	Hex	Binary No parity
NUL	00	00	00000000	@	64	40	01000000
SOH	01	01	00000001	A	65	41	01000000
STX	02	02	00000010	B	66	42	01000010
ETX	03	03	00000011	C	67	43	01000011
EOT	04	04	00000100	D	68	44	01000100
ENQ	05	05	00000101	E	69	45	01000101
ACK	06	06	00000110	F	70	46	01000110
BEL	07	07	00000111	G	71	47	01000111
BS	08	08	00001000	H	72	48	01001000
HT	09	09	00001001	I	73	49	01001001
LF	10	0A	00001010	J	74	4A	01001010
VT	11	0B	00001011	K	75	4B	01001011
FF	12	0C	00001100	L	76	4C	01001100
CR	13	0D	00001101	M	77	4D	01001101
SO	14	0E	00001110	N	78	4E	01001110
SI	15	0F	00001111	O	79	4F	01001111
DLE	16	10	00010000	P	80	50	01010000
DC1	17	11	00010001	Q	81	51	01010001
DC2	18	12	00010010	R	82	52	01010010
DC3	19	13	00010011	S	83	53	01010011
DC4	20	14	00010100	T	84	54	01010100
NAK	21	15	00010101	U	85	55	01010101
SYN	22	16	00010110	V	86	56	01010110
ETB	23	17	00010111	W	87	57	01010111
CAN	24	18	00011000	X	88	58	01011000
EM	25	19	00011001	Y	89	59	01011001
SUB	26	1A	00011010	Z	90	5A	01011010
ESC	27	1B	00011011	[91	5B	01011011
FS	28	1C	00011100	\	92	5C	01011100
GS	29	1D	00011101]	93	5D	01011101
RS	30	1E	00011110	^	94	5E	01011110
US	31	1F	00011111	_	95	5F	01011111
SP	32	20	00100000	`	96	60	01100000
!	33	21	00100001	a	97	61	01100001
"	34	22	00100010	b	98	62	01100010
#	35	23	00100011	c	99	63	01100011
\$	36	24	00100100	d	100	64	01100100
%	37	25	00100101	e	101	65	01100101
&	38	26	00100110	f	102	66	01100110
'	39	27	00100111	g	103	67	01100111
(40	28	00101000	h	104	68	01101000
)	41	29	00101001	i	105	69	01101001
*	42	2A	00101010	j	106	6A	01101010
+	43	2B	00101011	k	107	6B	01101011
,	44	2C	00101100	l	108	6C	01101100
-	45	2D	00101101	m	109	6D	01101101
.	46	2E	00101110	n	110	6E	01101110

Appendix D**ASCII Chart Continuation**

/	47	2F	00101111	o	111	6F	01101111
0	48	30	00110000	p	112	70	01110000
1	49	31	00110001	q	113	71	01110001
2	50	32	00110010	r	114	72	01110010
3	51	33	00110011	s	115	73	01110011
4	52	34	00110100	t	116	74	01110100
5	53	35	00110101	u	117	75	01110101
6	54	36	00110110	v	118	76	01110110
7	55	37	00110111	w	119	77	01110111
8	56	38	00111000	x	120	78	01111000
9	57	39	00111001	y	121	79	01111001
:	58	3A	00111010	z	122	7A	01111010
;	59	3B	00111011	{	123	7B	01111011
<	60	3C	00111100		124	7C	01111100
=	61	3D	00111101	}	125	7D	01111101
>	62	3E	00111110	~	126	7E	01111110
?	63	3F	00111111	DEL	127	7F	01111111

ASCII Control Codes

ASCII Char	Dec	Hex	Ctrl Key Equiv.	Definition	ASCII Char	Dec	Hex	Ctrl Key Equiv.	Definition
NUL	00	00	Ctrl @	Null Character	DC1	17	11	Ctrl Q	Data Control 1 - XON
SOH	01	01	Ctrl A	Start of Header	DC2	18	12	Ctrl R	Data Control 2
STX	02	02	Ctrl B	Start of Text	DC3	19	13	Ctrl S	Data Control 3 - XOFF
ETX	03	03	Ctrl C	End of Text	DC4	20	14	Ctrl T	Data Control 4
EOT	04	04	Ctrl D	End of Transmission	NAK	21	15	Ctrl U	Negative Acknowledge
ENQ	05	05	Ctrl E	Inquiry	SYN	22	16	Ctrl V	Synchronous Idle
ACK	06	06	Ctrl F	Acknowledge	ETB	23	17	Ctrl W	End of Trans Block
BEL	07	07	Ctrl G	Bell	CAN	24	18	Ctrl X	Cancel
BS	08	08	Ctrl H	Back Space	EM	25	19	Ctrl Y	End of Medium
HT	09	09	Ctrl I	Horizontal Tabulation	SUB	26	1A	Ctrl Z	Substitute
LF	10	0A	Ctrl J	Line Feed	ESC	27	1B	Ctrl [Escape
VT	11	0B	Ctrl K	Vertical Tabulation	FS	28	1C	Ctrl \	File Separator
FF	12	0C	Ctrl L	Form Feed	GS	29	1D	Ctrl]	Group Separator
CR	13	0D	Ctrl M	Carriage Return	RS	30	1E	Ctrl	Record Separator
SO	14	0E	Ctrl N	Shift Out	US	31	1F	Ctrl _	Unit Separator
SI	15	0F	Ctrl O	Shift In	SP	32	20		Space
DLE	16	10	Ctrl P	Data Link Escape					

Appendix E**iLog Error Messages**

Error #	Description	Note
-8003	User stopped logging readings.	
-10005	Failed to find the iSE.	Ethernet cable is disconnected, iSE is powered off, connections across the firewall require longer "connection to socket time out" setting.
-10006	Windows socket was closed.	
-10007	Windows socket error.	Wrong IP or wrong Port number was used.
-10008	The iSE failed to respond to a request.	Wrong IP or wrong Port number was used.
-10011	Response came empty.	No data was sent.
-10012	Device responded with "Serial Time Out" string.	Possibly the iLog is configured for wrong product model.
-10014	Terminal Server Mode when the Port is 1000.	Try Port 2000 in iLog configuration.
-15100	Error on obtaining the temperature reading.	Possibly the iLog is configured for wrong product model.



WARRANTY/DISCLAIMER

OMEGA ENGINEERING, INC. warrants this unit to be free of defects in materials and workmanship for a period of **one (1) year** from the date of purchase. In addition to OMEGA's standard warranty period, OMEGA Engineering will extend the warranty period for **one (1) additional year** if the warranty card enclosed with each instrument is returned to OMEGA.

If the unit malfunctions, it must be returned to the factory for evaluation. OMEGA's Customer Service Department will issue an Authorized Return (AR) number immediately upon phone or written request. Upon examination by OMEGA, if the unit is found to be defective, it will be repaired or replaced at no charge. OMEGA's WARRANTY does not apply to defects resulting from any action of the purchaser, including but not limited to mishandling, improper interfacing, operation outside of design limits, improper repair, or unauthorized modification. This WARRANTY is VOID if the unit shows evidence of having been tampered with or shows evidence of having been damaged as a result of excessive corrosion; or current, heat, moisture or vibration; improper specification; misapplication; misuse or other operating conditions outside of OMEGA's control. Components which wear are not warranted, including but not limited to contact points, fuses, and triacs.

OMEGA is pleased to offer suggestions on the use of its various products. However, OMEGA neither assumes responsibility for any omissions or errors nor assumes liability for any damages that result from the use of its products in accordance with information provided by OMEGA, either verbal or written. OMEGA warrants only that the parts manufactured by it will be as specified and free of defects. OMEGA MAKES NO OTHER WARRANTIES OR REPRESENTATIONS OF ANY KIND WHATSOEVER, EXPRESS OR IMPLIED, EXCEPT THAT OF TITLE, AND ALL IMPLIED WARRANTIES INCLUDING ANY WARRANTY OF MERCHANTABILITY AND FITNESS FOR A PARTICULAR PURPOSE ARE HEREBY DISCLAIMED. LIMITATION OF LIABILITY: The remedies of purchaser set forth herein are exclusive, and the total liability of OMEGA with respect to this order, whether based on contract, warranty, negligence, indemnification, strict liability or otherwise, shall not exceed the purchase price of the component upon which liability is based. In no event shall OMEGA be liable for consequential, incidental or special damages.

CONDITIONS: Equipment sold by OMEGA is not intended to be used, nor shall it be used: (1) as a "Basic Component" under 10 CFR 21 (NRC), used in or with any nuclear installation or activity; or (2) in medical applications or used on humans. Should any Product(s) be used in or with any nuclear installation or activity, medical application, used on humans, or misused in any way, OMEGA assumes no responsibility as set forth in our basic WARRANTY/DISCLAIMER language, and, additionally, purchaser will indemnify OMEGA and hold OMEGA harmless from any liability or damage whatsoever arising out of the use of the Product(s) in such a manner.

RETURN REQUESTS/INQUIRIES

Direct all warranty and repair requests/inquiries to the OMEGA Customer Service Department. **BEFORE RETURNING ANY PRODUCT(S) TO OMEGA, PURCHASER MUST OBTAIN AN AUTHORIZED RETURN (AR) NUMBER FROM OMEGA'S CUSTOMER SERVICE DEPARTMENT (IN ORDER TO AVOID PROCESSING DELAYS).** The assigned AR number should then be marked on the outside of the return package and on any correspondence.

The purchaser is responsible for shipping charges, freight, insurance and proper packaging to prevent breakage in transit.

FOR WARRANTY RETURNS, please have the following information available BEFORE contacting OMEGA:

1. Purchase Order number under which the product was PURCHASED,
2. Model and serial number of the product under warranty, and
3. Repair instructions and/or specific problems relative to the product.

FOR NON-WARRANTY REPAIRS, consult OMEGA for current repair charges. Have the following information available BEFORE contacting OMEGA:

1. Purchase Order number to cover the COST of the repair,
2. Model and serial number of product, and
3. Repair instructions and/or specific problems relative to the product.

OMEGA's policy is to make running changes, not model changes, whenever an improvement is possible. This affords our customers the latest in technology and engineering.

© Copyright 2008 OMEGA ENGINEERING, INC. All rights reserved. This document may not be copied, photocopied, reproduced, translated, or reduced to any electronic medium or machine-readable form, in whole or in part, without the prior written consent of OMEGA ENGINEERING, INC.

TRADEMARK NOTICE:  [®], *omega.com*[®],  **OMEGA**[®], and  are Trademarks of OMEGA ENGINEERING, INC.

PATENT NOTICE: This product is covered by one or more of the following patents: U.S. Pat. No. Des. 336,895; 5,274,577/ CANADA 2052599; 2052600 / ITALY 1249456; 1250938 / FRANCE BREVET No. 91 12756 / SPAIN 2039150; 2048066 / UK PATENT No. GB2 249 837; GB2 248 954 / GERMANY DE 41 34398 C2. Other US and International Patents pending or applied for.

Where Do I Find Everything I Need for Process Measurement and Control? **OMEGA...Of Course!** *Shop on line at omega.com*

TEMPERATURE

- Thermocouple, RTD & Thermistor Probes, Connectors, Panels & Assemblies
- Wire: Thermocouple, RTD & Thermistor
- Calibrators & Ice Point References
- Recorders, Controllers & Process Monitors
- Infrared Pyrometers

PRESSURE, STRAIN AND FORCE

- Transducers & Strain Gauges
- Load Cells & Pressure Gauges
- Displacement Transducers
- Instrumentation & Accessories

FLOW/LEVEL

- Rotameters, Gas Mass Flowmeters & Flow Computers
- Air Velocity Indicators
- Turbine/Paddlewheel Systems
- Totalizers & Batch Controllers

pH/CONDUCTIVITY

- pH Electrodes, Testers & Accessories
- Benchtop/Laboratory Meters
- Controllers, Calibrators, Simulators & Pumps
- Industrial pH & Conductivity Equipment

DATA ACQUISITION

- Data Acquisition & Engineering Software
- Communications-Based Acquisition Systems
- Plug-in Cards for Apple, IBM & Compatibles
- Datalogging Systems
- Recorders, Printers & Plotters

HEATERS

- Heating Cable
- Cartridge & Strip Heaters
- Immersion & Band Heaters
- Flexible Heaters
- Laboratory Heaters

ENVIRONMENTAL MONITORING AND CONTROL

- Metering & Control Instrumentation
- Refractometers
- Pumps & Tubing
- Air, Soil & Water Monitors
- Industrial Water & Wastewater Treatment
- pH, Conductivity & Dissolved Oxygen Instruments