

1 YEAR
WARRANTY

CE



User's Guide

Shop online at

omega.com[®]

Ω OMEGA[®]

omega.com

e-mail: info@omega.com

For latest product manuals:

omegamanual.info

ISO 9001
CERTIFIED
CORPORATE QUALITY

STAMFORD, CT

ISO 9002
CERTIFIED
CORPORATE QUALITY

MANCHESTER, UK

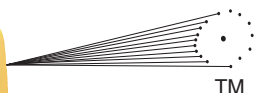

WITH BUILT-IN
PATENTED
LASER CIRCLE
SIGHTING

OSXL685
and OSXL689
High Performance
Infrared Thermometer

omega.com®

Ω OMEGA®

OMEGAnet® On-Line Service
omega.com

Internet e-mail
info@omega.com

Servicing North America:

U.S.A.: One Omega Drive, Box 4047
ISO 9001 Certified Stamford, CT 06907-0047
Tel: (203) 359-1660
FAX: (203) 359-7700
e-mail: info@omega.com

Canada: 976 Bergar
Laval (Quebec) H7L 5A1, Canada
Tel: (514) 856-6928
FAX: (514) 856-6886
e-mail: info@omega.ca

For immediate technical or application assistance:

U.S.A. and Sales Service: 1-800-826-6342/1-800-TC-OMEGA®

Canada: Customer Service: 1-800-622-2378/1-800-622-BEST®
Engineering Service: 1-800-872-9436/1-800-USA-WHEN®

Mexico: En Espa ñol: (001) 203-359-7803
FAX: (001) 203-359-7807
e-mail: espanol@omega.com
info@omega.com.mx

Servicing Europe:

Czech Republic: Frystatska 184, 733 01 Karviná, Czech Republic
Tel: +420 (0)59 6311899
FAX: +420 (0)59 6311114
Toll Free: 0800-1-66342
e-mail: info@omegashop.cz

Germany Austria Daimlerstrasse 26, D-75392 Deckenpfronn, Germany
Tel: +49 (0)7056 9398-0
FAX: +49 (0)7056 9398-29
Toll Free in Germany: 0800 639 7678
e-mail: info@omega.de

United Kingdom: One Omega Drive, River Bend Technology Centre
Northbank, Irlam, Manchester
ISO 9002 Certified M44 5BD United Kingdom
Tel: +44 (0)161 777 6611
FAX: +44 (0)161 777 6622
Toll Free in United Kingdom: 0800-488-488
e-mail: sales@omega.co.uk

It is the policy of OMEGA Engineering, Inc. to comply with all worldwide safety and EMC/EMI regulations that apply. OMEGA is constantly pursuing certification of its products to the European New Approach Directives. OMEGA will add the CE mark to every appropriate device upon certification.

The information contained in this document is believed to be correct, but OMEGA accepts no liability for any errors it contains, and reserves the right to alter specifications without notice.

WARNING: These products are not designed for use in, and should not be used for, human applications.

Table Content

1.Product Introduction	1
1-1 Features	1
1-2 Applications	1
1-3 Warnings and Cautions	2
2.Safety Information	2
2-1 Cautions	2
2-2 Safety symbols	2
3.Specifications	4
4.Operation Instructions	6
4-1 Quick Start	6
4-2 Unit Diagram	6
4-3 °C/ °F and Battery Change	7
4-4 Advanced Functions	8
5.PC Interface (OSXL689)	11
6.Techniques of Infrared Thermometer	13
5-1 Field of view (FOV) ratio	13
5-2 Emissivity	14
7.Maintenance	14
8.Emissivity Table	15

1. Product Introduction

Thank you for purchasing this infrared thermometer. The Infrared Thermometer is a non-contact infrared temperature measuring instrument. To measure a temperature, point the unit at the object, pull and hold the measuring trigger until the temperature is read. Make sure the target area is larger than the unit's Field of View. For large target objects make sure you are within target distance.

1-1 Features

- Patented Laser Circle Sighting
- 30:1 Field of View - OSXL685
- 50:1 Field of View - OSXL689
- Adjustable emissivity from 0.1 to 1.00 in 0.01 steps.
- Ultra low power consumption in shutdown mode.
- Extended long time measuring reliability.
- Backlit LCD display.
- °C or °F selectable.
- Electronic trigger lock.
- Temperature Data Storage
- High & Low Audible Alarms
- K Type Thermocouple Input - OSXL689
- USB PC Interface - OSXL689

1-2 Applications

- Electrical troubleshooting.
- Automotive repair and maintenance.
- Air conditioner.
- Science experiment.
- Manufacturing processes of semiconductor technology.
- Test terminals on circuits.
- Food safety and processing.
- Perform HVAC energy audits.

1-3 Warnings and Cautions

CAUTION

You may receive harmful laser radiation exposure if you do not adhere to the warnings listed below:

- **Use of controls or adjustments or performance of procedures other than those specified here may result in hazardous radiation exposure.**
 - **Do not look at the laser beam coming out of the lens or view directly with optical instruments - eye damage can result.**
 - **Use extreme caution when operating the laser sighting.**
 - **Never point the laser beam at a person.**
 - **Do not attempt to open the thermometer. There are no user serviceable parts.**
 - **Keep out of the reach of all children.**
-

Refer to the inside back cover for product warning label.

2.Safety Information

Read the following instruction manual carefully before attempting to operate the thermometer. Only qualified personnel should perform repairs which are not covered in this manual.

2-1 Cautions!

- DO NOT submerge the unit in water.
- This product is not designed for use in medical evaluations. The product can only be used to measure body temperature simply for reference. They are meant for industrial and scientific purposes.

2-2 Safety symbols



Dangerous, refer to this manual before using the meter.



CE Certification.

This instrument conforms to the following standards:

EN61326 : Electrical equipment for measurement , control and laboratory use.

IEC61000-4-2 : Electrostatic discharge immunity test.

IEC61000-4-3 : Radiated , radio-frequency, electromagnetic field immunity test.

IEC61000-4-8 : Power frequency magnetic field immunity test.

Tests were conducted using a frequency range of 80-1000MHz with the instrument in three orientations. The average error for the three orientations is $\pm 0.5^{\circ}\text{C}$ ($\pm 1.0^{\circ}\text{F}$) at 3V/m throughout the spectrum. However, between 781-1000MHz at 3V/m, the instrument may not meet its stated accuracy.

3. Specifications

	OSXL685	OSXL689
Temperature Range	-50 to 1000°C (-58 to 1832°F)	
Accuracy	$\pm 3.0^{\circ}\text{C}$ ($\pm 5^{\circ}\text{F}$) From -50 to -20°C (-58 to -4°F) $\pm 2.0^{\circ}\text{C}$ ($\pm 3^{\circ}\text{F}$) From -20 to 100°C (-4 to 212°F) $\pm 2\%$ From 100 to -1000°C (212 to 1832°F)	
Thermopile	8 to 14 μm	
Repeatability	$\pm 1^{\circ}\text{C}$ or $\pm 2^{\circ}\text{F}$	
Resolution	0.1°C (0.1°F)	
Response Time	500 ms.	
Emissivity	Adjustable 0.1 to 1.0	
Distance/Spot Ratio	30:1	50:1
Supply Voltage	9V	
Operating Temp.	0 to 50°C, 10 to 90% RH	
°C/°F Switchable	YES	
Auto Power Off	Automatically after approx 6 sec.	
Backlight	YES	
Laser Sight Switchable	YES - Laser Circle	
Max/Min/Avg.	YES	
Data Storage	10 Points	
Alarms	High and Low	
K Type TC	—	-200/1300°C
TC Input Accuracy	—	0.5% Rdg+1°C
USB Port	—	YES
Auto Measuring	YES	
Dual Display	YES	
Tripod mount	YES	
Size	127 × 47 × 200mm	
Weight	330g Approx.	

3. Specifications con't.

Laser Sighting

Wavelength (Color):	630 to 670 nanometers (red)
Operating Distance:	Up to 10 ft.
Max. Output Optical Power:	<1mW at 75°F ambient temperature, Class II Laser Product
European Classification:	Class 2, EN60825-1
FDA Classification:	Complies with 21 CFR Chapter 1, Subchapter J
Beam Diameter:	5 mm
Beam Divergence:	<2mrad
Laser Configuration:	Dot and Circle
Power Switch:	Slide switch, ON-OFF
Power Indicator:	Laser icon on display
Power:	Supplied by the thermometer
Identification Label:	Located on the right side of the thermometer
Warning and Certification Label:	Located on the left side of the thermometer

4. Operations Of Instrument

4-1 Quick Start

To measure a temperature, point the unit at the target, pull the trigger and hold. Make sure the target area is within the field of view of the instrument. The laser circle sighting is used to indicate the perimeter of the instrument's field of view.

4-2 Unit Diagram

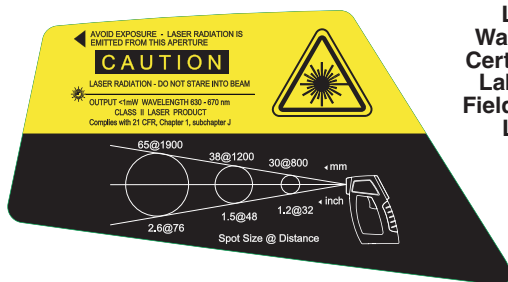
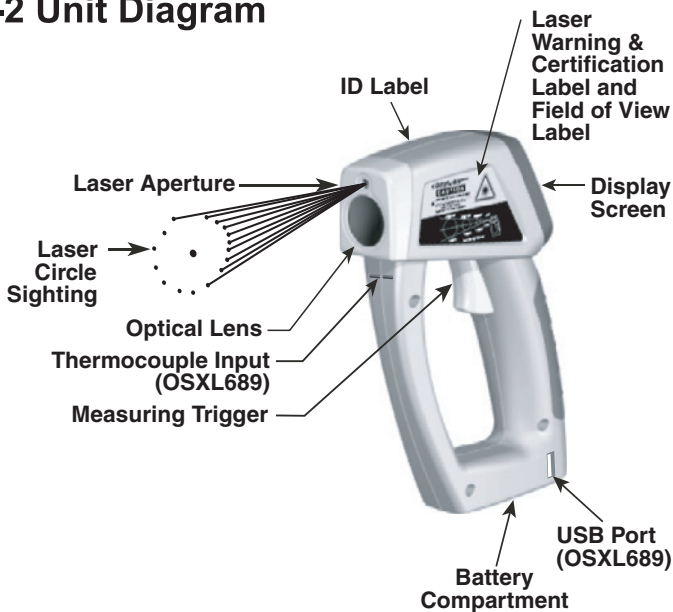

LCD & Control Panel

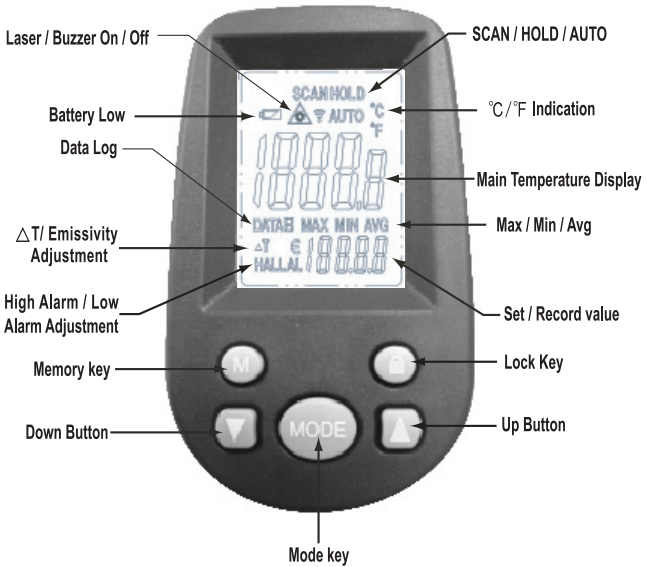

4-3 °C/°F, Laser Switch and Battery Replacement

The unit is powered by a 9V battery and displays temperatures in either °C or °F. Pull the cover at the bottom of the unit and open the cover by following the step 1 and 2.

There are two slide switches in front of the battery compartment. One is for °F/°C display and the other is for laser sighting. To change the battery, directly place the battery in the battery compartment.

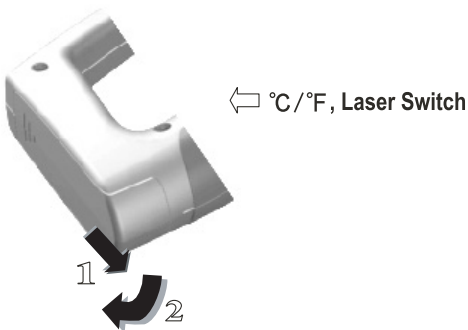

4-4 Advanced Functions

4-4-1 AUTO Mode-Continuous Operation

From the SCAN mode (Trigger is pulled), you can lock the trigger electronically and measure temperature continuously (AUTO mode) by pressing the **LOCK** key. The AUTO icon will appear on the display. Pressing the **LOCK** key again will disable the AUTO mode. AUTO icon will disappear from the display. If the trigger is pulled, the unit stays in the SCAN mode. If the trigger is released, the unit will go to HOLD mode and will shut itself off after about 6 seconds.

The following table shows an overall functional flow chart of the thermometer:

Mode	Press Mode Key	Press Up Key	Press Down Key
SCAN	SCAN → AUTO	----	----
AUTO	AUTO → DATA Record	----	----
DATA RECORD	DATA RECORD → DATA RECALL (Press M key to record)	+ Memory Location (Flashing)	- Memory Location (Flashing)
DATA RECALL	DATA RECALL → Max Temp	+ Memory Location Display Data Memory	- Memory Location Display Data Memory
Max Temp	Max Temp → Min Temp	+ Memory Location (Flashing)	- Memory Location (Flashing)
Min Temp	Min Temp → Avg Temp	+ Memory Location (Flashing)	- Memory Location (Flashing)
Avg Temp	Avg Temp → ΔT	+ Memory Location (Flashing)	- Memory Location (Flashing)
ΔT	ΔT → TC	+ Memory Location (Flashing)	- Memory Location (Flashing)
TC	TC → Emissivity (OSXL689)	+ Memory Location (Flashing)	- Memory Location (Flashing)
Emissivity	Emissivity → High Alarm	+ Emissivity	- Emissivity
HAL	High Alarm → Low Alarm	+ Alarm Set Point	- Alarm Set Point
LAL	Low Alarm → SCAN/HOLD	+ Alarm Set Point	- Alarm Set Point

4-4-2 Max, Min, Avg, ΔT Temperature

You can review the Maximum, Minimum, Average, and differential (Max - Min) temperatures on the display by pressing the **Mode** key. If the trigger is pulled at the same time, the display will show SCAN icon and all the values are in real time. If the trigger is released, the display will show the HOLD icon and all the values are the last readings before the trigger is released.

4-4-3 Temperature Data Storage & Recall - DATA Mode

You can store up to 10 temperature data points (Memory Location 1 thru A). When you are in DATA RECORD mode, set the memory location using the Up or Down arrow keys, then press the **M** key. The unit will store the temperature data in the current memory location.

You can review (recall) the stored data by going to the DATA RECALL mode using the **Mode** key and pressing the Up/Down keys. You can then review memory locations 1 thru A.

NOTE

The unit stores all temperature data, emissivity value, high and low alarm set points in the non-volatile memory. Changing the battery will not affect these values.

Remarks

- * **LOCK**: Push the  button to continuously measure and display the temperature without pull the measuring trigger.
- * The above functions can be activated always in any step of operations mode in flow-chart.
- * In Data Record Mode, pressing the **M** key will record the data in the corresponding memory location.
- * In Data Recall Mode, you can delete all recorded data by going to DATA \emptyset memory location and pressing the **M** key.
- * Pulling the Trigger or pressing any of the keys will turn on LCD backlight.

NOTE

A 6" Surface Probe (Model SPHT-K-6) is included with Model OSXL689.

5. PC Interface (OSXL689)

This infrared thermometer has a USB PC interface. It comes with a USB cable and CD software. Install the PC software before connecting the thermometer to the PC USB port. The minimum PC system requirements are:

- Windows XP
- 64 MB of RAM
- 5 MB of Disk space

After completing the software installation, run the program and connect the thermometer to the PC using the USB port. Turn on the thermometer by pulling the trigger. After a few seconds the PC recognizes the thermometer connection and a USB icon appears on the thermometer's display. The PC now shows the same target temperature as what is displayed on the thermometer. The thermometer's trigger is locked by the USB connections so there is no need to continue pulling the trigger. The following picture is what you see on the PC.

The target temperature is displayed in either °F or °C. Then the Date (yy-mm-dd) and Time (Hour:Minute:Second) are displayed. You can switch between °F and °C temperature display by clicking on the unit of measurement (°F or °C).

5-1 Recording Temperature Data to a File

Set your recording interval in terms of Hours, Minutes, Seconds. This is the time interval between every temperature data point. Then check on **Record** key. A selection file text box opens. Enter a text file name, and click on **Save** key to start the recording process. Now temperature data are being saved in the text file at the specified recording interval. You can determine the recording process by clicking the **Stop** key. Now you can go back and review the data text file.

You can exit the program by clicking the **Exit** key.

Infrared Thermometer

Target Temperature

125.6 °F

°C
 °F

2006-5-02 9:50:26

Record Interval Hour Minute Second

Record

Stop

Exit

5. Techniques Of Infrared Thermometer

5-1 Field of View (FOV) ratio =Distance to Diameter (DS) ratio

The field of view is the angle of vision at which the instrument operates, and is determined by the optics of the unit. The FOV is the ratio of the distance from the target to the target diameter. The smaller the target, the closer you should be to it. When the target diameter is small, it is important to bring the thermometer closer to the target to ensure that the target area is larger than the optical field of view.

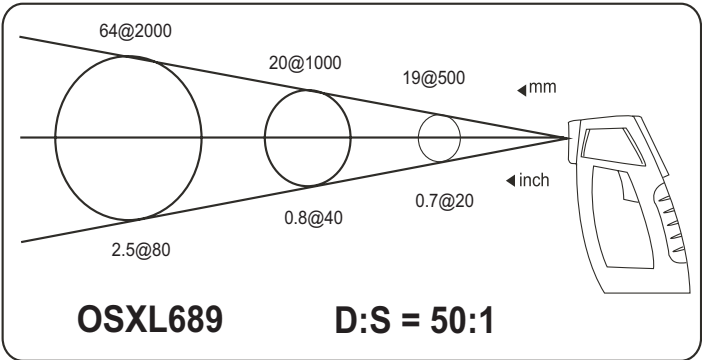
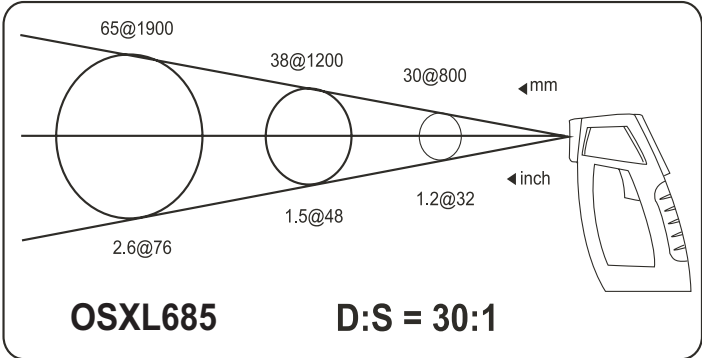

6-2 Emissivity

Emissivity is the ability of an object to emit or absorb energy. Perfect emitters have an emissivity of 1, emitting 100% of incident energy. An object with an emissivity of 0.8 will absorb 80% and reflect 20% of the incident energy. Emissivity is defined as ratio of the energy radiated by an object at given temperature to the energy emitted by a perfect radiator at the same temperature. All values of emissivity fall between 0.0 and 1.0.

7. Maintenance

Cleaning the lens: Blow off loose particles using clean compressed air. Gently brush remaining debris away with a camel's hair brush. Carefully wipe the surface with a moist cotton swab. The swab may be moistened with water.

NOTE:

DO NOT use solvents to clean the lens.

Cleaning the housing:

Use soap and water on a damp sponge or soft cloth.

PATENT NOTICE:

U.S. PAT. B1 5,368,392; 5,524,984; 5,727,880; 5,823,678; 5,823,679; 6,123,453; 6,267,500 B1; 6,341,891 B1; 6,377,400 B1; 6,540,398 B2; 6,614,830 B1; 6,633,434 B2; 6,659,639; 6,901,089 B1 / Canada 2,114,806; 2,317,734 / France 2 756 920; 2 767 921; 2 773 213; 2 773 214 / Germany G 94 22 197.9; G 94 22 203.7 / Holland 1007752; / U.K. Registered 2,237,493; 2,320,324; 9726133.3 / EPO 0 644,408 B2; EPO 1085 307 A1.
Other U.S. and Foreign Patents Pending.

8. Emissivity Table

Material	Temp °C / °F	Emissivity
Gold(pure highly polished)	227/440	0.02
Aluminum foil	27/81	0.04
Aluminum disc	27/81	0.18
Aluminum household(flat)	23/73	0.01
Aluminum (polished plate 98.3%)	227/400	0.04
	577/1070	0.06
Aluminum (rough plate)	26/78	0.06
Aluminum (oxidized @599C) ^o	199/390	0.11
	599/1110	0.19
Aluminum surfaced roofing	38/100	0.22
Tin(bright tinned iron sheet)	25/77	0.04
Nickel wire	187/368	0.1
Lead(pure 99.95-unoxidized)	127/260	0.06
Copper	199/390	0.18
	599/1110	0.19
Steel	199/390	0.52
	599/1110	0.57
Zinc galvanized sheet iron(bright)	28/82	0.23
Brass(highly polished):	247/476	0.03
Brass(hard rolled-polished w/lines):	21/70	0.04
Iron galvanized(bright)	-	0.13
Iron plate(completely)	20/68	0.69
Rolled sheet steel	21/71	0.66
Oxidized iron	100/212	0.74
Wrought iron	21/70	0.94
Molten iron	1299-1399/3270-2550	0.29
Copper(polished)	21-117/70-242	0.02
Copper(scraped shiny not mirrored)	22/72	0.07
Copper(Plate heavily oxidized)	25/77	0.78
Enamel(white fused on iron)	19/66	0.9
Formica	27/81	0.94
Frozen soil	-	0.93
Brick(red-rough)	21/70	0.93
Brick(silica-unglazed rough)	1000/1832	0.8
Carbon(T-carbon 0.9% ash)	127/260	0.81
Concrete	-	0.94
Glass(smooth)	22/72	0.94
Granite(polished)	21/70	0.85
Ice	0/32	0.97
Marble(light gray polished)	22/72	0.93
Asbestos board	23/74	0.96
Asbestos paper	38/100	0.93
	371/700	0.95
Asphalt(paving)	4/39	0.97

State-of-the-art infrared technology

WARRANTY/DISCLAIMER

OMEGA ENGINEERING, INC. warrants this unit to be free of defects in materials and workmanship for a period of **13 months** from date of purchase. OMEGA's WARRANTY adds an additional one (1) month grace period to the normal **one (1) year product warranty** to cover handling and shipping time. This ensures that OMEGA's customers receive maximum coverage on each product.

If the unit malfunctions, it must be returned to the factory for evaluation. OMEGA's Customer Service Department will issue an Authorized Return (AR) number immediately upon phone or written request. Upon examination by OMEGA, if the unit is found to be defective, it will be repaired or replaced at no charge. OMEGA's WARRANTY does not apply to defects resulting from any action of the purchaser, including but not limited to mishandling, improper interfacing, operation outside of design limits, improper repair, or unauthorized modification. This WARRANTY is VOID if the unit shows evidence of having been tampered with or shows evidence of having been damaged as a result of excessive corrosion; or current, heat, moisture or vibration; improper specification; misapplication; misuse or other operating conditions outside of OMEGA's control. Components in which wear is not warranted, include but are not limited to contact points, fuses, and triacs.

OMEGA is pleased to offer suggestions on the use of its various products. However, OMEGA neither assumes responsibility for any omissions or errors nor assumes liability for any damages that result from the use of its products in accordance with information provided by OMEGA, either verbal or written. OMEGA warrants only that the parts manufactured by the company will be as specified and free of defects. OMEGA MAKES NO OTHER WARRANTIES OR REPRESENTATIONS OF ANY KIND WHATSOEVER, EXPRESSED OR IMPLIED, EXCEPT THAT OF TITLE, AND ALL IMPLIED WARRANTIES INCLUDING ANY WARRANTY OF MERCHANTABILITY AND FITNESS FOR A PARTICULAR PURPOSE ARE HEREBY DISCLAIMED. LIMITATION OF LIABILITY: The remedies of purchaser set forth herein are exclusive, and the total liability of OMEGA with respect to this order, whether based on contract, warranty, negligence, indemnification, strict liability or otherwise, shall not exceed the purchase price of the component upon which liability is based. In no event shall OMEGA be liable for consequential, incidental or special damages.

CONDITIONS: Equipment sold by OMEGA is not intended to be used, nor shall it be used: (1) as a "Basic Component" under 10 CFR 21 (NRC), used in or with any nuclear installation or activity; or (2) in medical applications or used on humans. Should any Product(s) be used in or with any nuclear installation or activity, medical application, used on humans, or misused in any way, OMEGA assumes no responsibility as set forth in our basic WARRANTY/DISCLAIMER language, and, additionally, purchaser will indemnify OMEGA and hold OMEGA harmless from any liability or damage whatsoever arising out of the use of the Product(s) in

RETURN REQUESTS / INQUIRIES

Direct all warranty and repair requests/inquiries to the OMEGA Customer Service Department. BEFORE RETURNING ANY PRODUCT(S) TO OMEGA, PURCHASER MUST OBTAIN AN AUTHORIZED RETURN (AR) NUMBER FROM OMEGA'S CUSTOMER SERVICE DEPARTMENT (IN ORDER TO AVOID PROCESSING DELAYS). The assigned AR number should then be marked on the outside of the return package and on any correspondence.

The purchaser is responsible for shipping charges, freight, insurance and proper packaging to prevent breakage in transit.

FOR **WARRANTY** RETURNS, please have the following information available BEFORE contacting OMEGA:

1. Purchase Order number under which the product was PURCHASED,
2. Model and serial number of the product under warranty, and
3. Repair instructions and/or specific problems relative to the product.

FOR **NON-WARRANTY** REPAIRS, consult OMEGA for current repair charges. Have the following information available BEFORE contacting OMEGA:

1. Purchase Order number to cover the COST of the repair,
2. Model and serial number of the product, and
3. Repair instructions and/or specific problems relative to the product.

OMEGA's policy is to make running changes, not model changes, whenever an improvement is possible. This affords our customers the latest in technology and engineering.

OMEGA is a registered trademark of OMEGA ENGINEERING, INC.

© Copyright 2006 OMEGA ENGINEERING, INC. All rights reserved. This document may not be copied, photocopied, reproduced, translated, or reduced to any electronic medium or machine-readable form, in whole or in part, without the prior written consent of OMEGA ENGINEERING, INC.

Where Do I Find Everything I Need for Process Measurement and Control? **OMEGA...Of Course!** *Shop online at omega.com*

TEMPERATURE

- ☑ Thermocouple, RTD & Thermistor Probes, Connectors, Panels & Assemblies
- ☑ Wire: Thermocouple, RTD & Thermistor
- ☑ Calibrators & Ice Point References
- ☑ Recorders, Controllers & Process Monitors
- ☑ Infrared Pyrometers

PRESSURE, STRAIN AND FORCE

- ☑ Transducers & Strain Gages
- ☑ Load Cells & Pressure Gages
- ☑ Displacement Transducers
- ☑ Instrumentation & Accessories

FLOW/LEVEL

- ☑ Rotameters, Gas Mass Flowmeters & Flow Computers
- ☑ Air Velocity Indicators
- ☑ Turbine/Paddlewheel Systems
- ☑ Totalizers & Batch Controllers

pH/CONDUCTIVITY

- ☑ pH Electrodes, Testers & Accessories
- ☑ Benchtop/Laboratory Meters
- ☑ Controllers, Calibrators, Simulators & Pumps
- ☑ Industrial pH & Conductivity Equipment

DATA ACQUISITION

- ☑ Data Acquisition & Engineering Software
- ☑ Communications-Based Acquisition Systems
- ☑ Plug-in Cards for Apple, IBM & Compatibles
- ☑ Datalogging Systems
- ☑ Recorders, Printers & Plotters

HEATERS

- ☑ Heating Cable
- ☑ Cartridge & Strip Heaters
- ☑ Immersion & Band Heaters
- ☑ Flexible Heaters
- ☑ Laboratory Heaters

ENVIRONMENTAL MONITORING AND CONTROL

- ☑ Metering & Control Instrumentation
- ☑ Refractometers
- ☑ Pumps & Tubing
- ☑ Air, Soil & Water Monitors
- ☑ Industrial Water & Wastewater Treatment
- ☑ pH, Conductivity & Dissolved Oxygen Instruments