

1 YEAR
WARRANTY

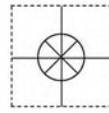

User's Guide



Shop online at

omega.com[®]

Ω OMEGA[®]

omega.com

e-mail: info@omega.com

For latest product manuals:

omegamanual.info

ISO 9001
CERTIFIED
CORPORATE QUALITY

STAMFORD, CT

ISO 9001
CERTIFIED
CORPORATE QUALITY

MANCHESTER, UK

LVU-201A Series Ultrasonic Level Transmitter



OMEGAnet® Online Service omega.com	Internet e-mail info@omega.com
--	--

Servicing North America:

U.S.A.: ISO 9001 Certified Omega Engineering, Inc., One Omega Drive, P.O. Box 4047
Stamford, CT 06907-0047 USA
Toll Free: 1-800-826-6342 TEL: (203) 359-1660
FAX: (203) 359-7700 e-mail: info@omega.com

Canada: 976 Bergar
Laval (Quebec), Canada H7L 5A1
Toll-Free: 1-800-826-6342 TEL: (514) 856-6928
FAX: (514) 856-6886 e-mail: info@omega.ca

For immediate technical or application assistance:

U.S.A. and Canada: Sales Service: 1-800-826-6342/1-800-TC-OMEGA®
Customer Service: 1-800-622-2378/1-800-622-BEST®
Engineering Service: 1-800-872-9436/1-800-USA-WHEN®

Mexico: En Español: 001 (203) 359-7803 FAX: (001) 203-359-7807
info@omega.com.mx e-mail: espanol@omega.com

Servicing Europe:

Benelux: Managed by the United Kingdom Office
Toll-Free: 0800 099 3344 TEL: +31 20 347 21 21
FAX: +31 20 643 46 43 e-mail: sales@omega.nl

Czech Republic: Frystatska 184
733 01 Karviná, Czech Republic
Toll-Free: 0800-1-66342 TEL: +420-59-6311899
FAX: +420-59-6311114 e-mail: info@omegashop.cz

France: Managed by the United Kingdom Office
Toll-Free: 0800 466 342 TEL: +33 (0) 161 37 29 00
FAX: +33 (0) 130 57 54 27 e-mail: sales@omega.fr

Germany/Austria: Daimlerstrasse 26
D-75392 Deckenpfronn, Germany
Toll-Free: 0 800 6397678 TEL: +49 (0) 7059 9398-0
FAX: +49 (0) 7056 9398-29 e-mail: info@omega.de

United Kingdom: ISO 9001 Certified OMEGA Engineering Ltd.
One Omega Drive, River Bend Technology Centre, Northbank
Irlam, Manchester M44 5BD England
Toll-Free: 0800-488-488 TEL: +44 (0)161 777-6611
FAX: +44 (0)161 777-6622 e-mail: sales@omega.co.uk

It is the policy of OMEGA Engineering, Inc. to comply with all worldwide safety and EMC/EMI regulations that apply. OMEGA is constantly pursuing certification of its products to the European New Approach Directives. OMEGA will add the CE mark to every appropriate device upon certification. The information contained in this document is believed to be correct, but OMEGA accepts no liability for any errors it contains, and reserves the right to alter specifications without notice.
WARNING: These products are not designed for use in, and should not be used for, human applications.

An ultrasonic sound wave is pulsed two times per second from the base of the transducer. The sound wave reflects against the process medium below and returns to the transducer. The microprocessor based electronics measure the time of flight between the sound generation and receipt, and translates this figure into the distance between the transmitter and process medium below.

Table of Contents

Specifications/Dimensions: 4
 Components: 4
 Safety Precautions 5
 Make a Fail-Safe System: 5
 Menu / Definitions 6
 Programming: 8
 Steps for Basic Configuration: 8
 Selecting Units of Operation: 8
 Configure Sensor’s Current Range: 9
 Set Operational Range Using MAXR & MINR: 10
 Wiring 11
 Installation 12
 Mounting Guide 12
 Fitting Selection 13
 Tank Adapter 13
 Riser 13
 Flange 13
 Side Mount Fitting 14
 Stand Pipe 14
 Appendix: 15
 Return to Factory Settings: 15
 Change Display Units: 15
 Troubleshooting: 16
 Other Hints: 17
 Testing the transmitter: 18
 User Settings: 18

SPECIFICATIONS/DIMENSIONS

Step Two

- Range: 0.5 to 18 feet (15cm to 5.4m)
- Accuracy: ± 0.25% of span in air
- Resolution: 0.125" (3mm)
- Frequency: 50kHz
- Pulse rate: 2 pulses per second
- Beam width: 8° conical
- Dead band: 0.5' (15cm) minimum
- Blocking distance: 0.5 to 18 feet (15cm to 5.4m)
- Display type: 4 segment LCD
- Display units: Inch or cm
- Memory: Non-volatile
- Supply voltage: 12-32 VDC
- Max loop resistance: 900 Ohms @ 32 VDC
- Signal output: 4-20mA, 12-32 VDC
- Signal invert: 4-20 mA / 20-4 mA
- Configuration: Push button
- Fail-Safe diagnostics: Revert to 4mA, 22mA or remains constant
- Temperature rating: F: -40° to 140°
C: -40° to 60°
- Temp. compensation: Automatic over entire range
- Pressure rating: 30 psi (2 bar) @ 25 °C.,
derated @ 1.667 psi (.113 bar) per °C. above 25 °C.
- Enclosure rating: NEMA 4X (IP65)
- Enclosure material: Polypropylene (PP), U.L. 94VO
- Transducer material: Polyvinylidene Fluoride (PVDF)
- Process mount: 2" NPT (2" G)
- Conduit entrance: Single, 1/2" NPT
- CE compliance: EN 50082-2 immunity
EN 55011 emission

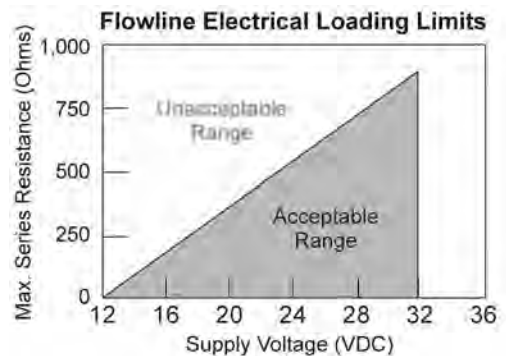
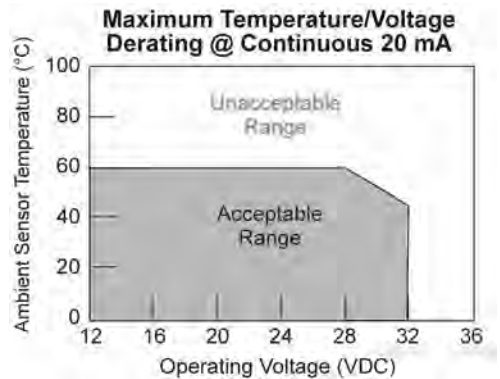
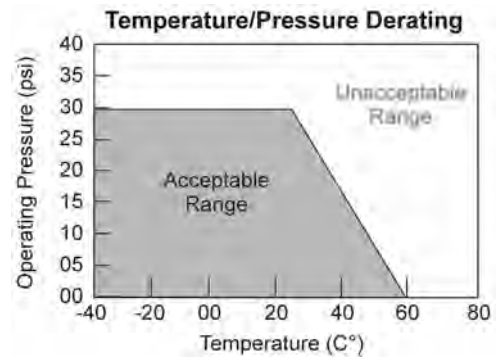
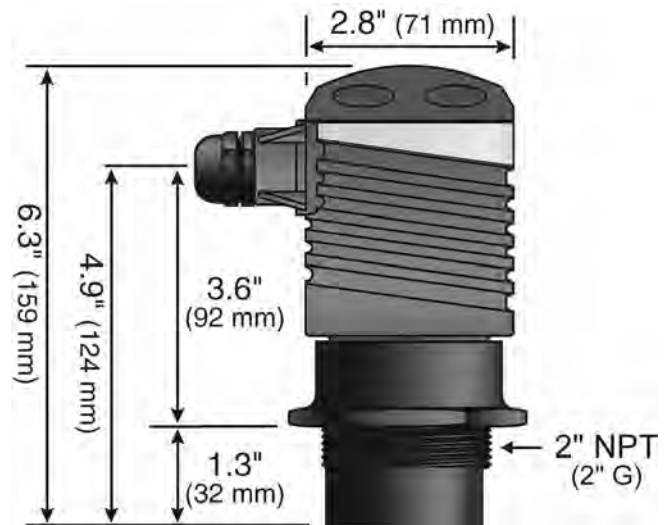

Components:

P/N	Max. Range	Dead Band
LVU-201A	18.0' (5.4 m)	6" (15.2cm)

! About this Manual: PLEASE READ THE ENTIRE MANUAL PRIOR TO INSTALLING OR USING THE PRODUCT. This manual includes information on all four versions of the continuous ultrasonic level transmitter from Omega Engineering, model LVU-201A. Please refer to the part number located on the sensor label to verify the exact model which you have purchased.

! User's Responsibility for Safety: Omega Engineering manufactures a wide range of liquid level sensors and technologies. While each of these technologies are designed to operate in a wide variety of applications, it is the user's responsibility to select a technology that is appropriate for the application, install it properly, perform tests of the installed system, and maintain all components. The failure to do so could result in property damage or serious injury.

! Proper Installation and Handling: Because this is an electrically operated device, only properly trained staff should install and/or repair this product. Use a proper sealant with all installations. Never over tighten the transmitter within the fitting. Always check for leaks prior to system start-up.

! Wiring and Electrical: A supply voltage of 12-32 VDC is used to power the LUV-201A. The sensor system should never exceed a maximum of 32 VDC. Electrical wiring of the sensor should be performed in accordance with all applicable national, state, and local codes.

! Temperature and Pressure: The LVU-201A is designed for use in application temperatures from -40 °C (-40 °F) to 60 °C (140 °F), and for use at pressures up to 30 psi @ 25 °C, derated @ 1.667 psi per °C above 25 °C.

! Material compatibility: The continuous ultrasonic level transmitter, LVU-201A, is made of two materials. The enclosure is of Polypropylene (PP) and the transducer is made of Polyvinylidene fluoride (PVDF). Make sure that the model which you have selected is chemically compatible with the application liquids. While the transmitter housing is liquid resistant when installed properly, it is not designed to be immersed. It should be mounted in such a way that it does not normally come into contact with fluid.

! Flammable, Explosive and Hazardous Applications: DO NOT USE THE LVU201A GENERAL PURPOSE TRANSMITTER IN HAZADROUS LOCATIONS.

! Make a Fail – Safe System: Design a fail–safe system that accommodates the possibility of transmitter or power failure. In critical applications, Omega Engineering recommends the use of redundant backup systems and alarms in addition to the primary system.

Getting around: The LVU-201A is configured by the use of four push buttons (UP, DOWN, MENU and SET) and a LCD display. The display will always read the distance from the bottom of the sensor to the surface of the liquid (air gap).

Main Menu: Holding down the MENU button will scroll down the main menu of the LVU-201A.

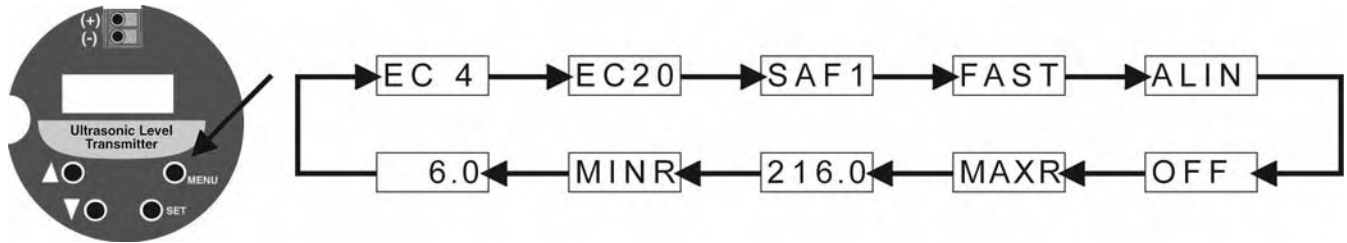

Definitions:

EC4: This is the 4 mA setting for the LVU-201A. The EC4 is the distance from the bottom of the LVU-201A to the 4 mA set point. Typically, the EC4 or 4mA setting is at the bottom of the tank. The further away from the sensor, the larger the number will be. This setting is measured in either inches or centimeters on the display.

EC20: This is the 20 mA setting for the LVU-201A. The EC20 is the distance from the bottom of the LVU-201A to the 20 mA set point. Typically, the EC20 or 20 mA setting is at the top of the tank. The closer to the sensor, the smaller the number will be. This setting is measured in either inches or centimeters on the display.

Reversing the 4-20 mA signal: Setting the EC4 at the bottom of the tank and EC20 at the top of the tank will create a 4-20 mA output that has 4 mA at empty and 20 mA at full. To reverse the 4-20 mA signal, simply set EC4 at the top of the tank and EC20 at the bottom of the tank.

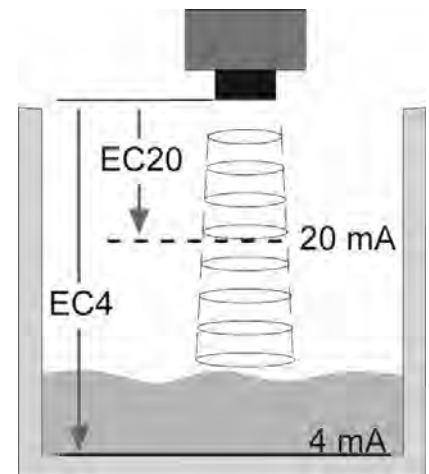

SAF1/SAF2/SAF3: This is the fail-safe setting for the LVU-201A. Use the SAF_ setting to determine a fail-safe mode for the current signal. When [SAF1] is set, the current will increase to 22 mA if the signal becomes LOST. When [SAF2] is set, the current will decrease to 4 mA if the signal becomes LOST. When [SAF3] is set, the current will remain constant if the signal becomes LOST.

LOST: A LOST state will occur when the sensor does not receive a return sound pulse signal. When this occurs, the display will show LOST and the current output will default to the SAF_ setting. The sensor will remain in this condition until a valid signal is acquired. No values in the MENU can be changed until the LOST condition has been resolved.

FAST/SLOW: Setting for echo averaging as well as the reaction time for SAF_ setting in the LVU-201A:

FAST: Is the typical and default setting for the LVU-201A to operate. The LVU-201A will average 2 signal responses per second and update every second. In FAST mode, the sensor will continue to search for a valid reading for 30 seconds before going into the LOST state.

SLOW: Is designed to help dampen out effects caused by severe turbulence. The LVU-201A will average signal returns over the preceding 10 seconds. In SLOW mode, the sensor will continue to search for a valid reading for 2.5 minutes before going into the LOST state.

To change the FAST/SLOW setting, follow the steps below:

1. Hold [MENU] key until FAST or SLOW appears in the display.
2. Release [MENU] key and hold [SET] key to toggle between FAST and SLOW.
3. When desired setting is reached, release [SET] key. The last display setting will be locked into memory.

ALIN: Use this mode as an aid to leveling the sensor installed in a self-aligning or rotational bulk head fitting. Display will show the return signal strength in dB's. For optimum alignment, first energize the unit and receive a valid return signal. Then select the ALIN mode and adjust the LVU-201A until the display is maximized. Typical readings range between 2 and 60 dB's.

ON/OFF: This is the actual activation setting for ALIN mode. Default is [OFF]. Set to [ON] to view the ALIN readings. The ALIN mode must be turned [OFF] when alignment is completed.

To ALIN a sensor, follow the steps below:

1. Hold [MENU] key until OFF appears in the display.
 - a. OFF will appear right after ALIN
2. Release [MENU] key and immediately hold [SET] key to toggle from OFF to ON.
3. Release [SET] key. The LVU-201A is now in ALIN mode.
4. Adjust the sensor so the display shows the largest value.
 - a. When the highest value is shown, lock the sensor in place.
5. To exit ALIN mode, repeat steps 1-4 changing from ON to OFF.

MAXR: The MAXR sets the maximum tank height and will filter out all returns greater than this value. Regardless of how the EC4 and EC20 are set, set MAXR to the Empty tank distance or greater.

(VALUE): The number after MAXR shows the setting for MAXR. This value is the actual MAXR setting that can be changed for the application. The maximum distance is 216.0 inches.

MINR: The MINR value is the dead band closest to the transducer face where no signal will be generated. The MINR sets the minimum distance between the liquid and the transducer. Regardless of how the EC4 and EC20 are set, set MINR to the FULL tank distance.

(Value): The number after MINR shows the setting for MINR. This value is the actual MINR setting that can be changed for the application. The minimum distance is 6.0 inches.

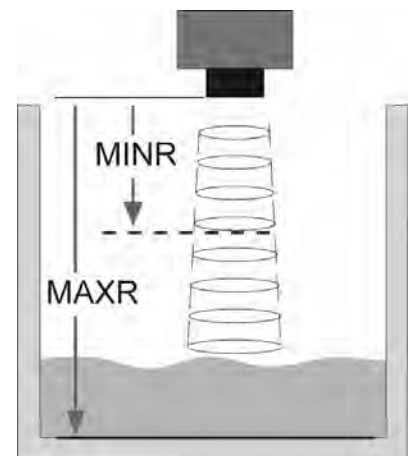

Steps for Basic Configuration:

1. Select and Set the units of operation.
2. Configure the Sensor's Current Range using the EC4 and EC20 settings in the main menu.
 - a. The tank level does not need to be empty or full for this operation.
3. Set the Operational Range using the MAXR and MINR settings in the main menu.
 - a. The tank level does not need to be empty or full for this operation.
4. Select the Fail-Safe setting using the SAF_ setting in the main menu.

Selecting Units of Operation (Inches or CM):

The default for the LVU-201A is to display in inches. If power is removed, the sensor will remain in the selected mode. This operation selects the units of operation for the configuration of the transmitter. This selection has no effect on the output of the sensor. The 4-20 mA output can be scaled to read in any engineering units.

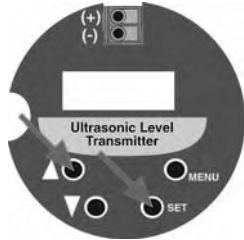
To change to centimeters

1. Remove power to the LVU-201A and wait 10 seconds.
2. Simultaneously press [Δ] and [SET] while adding power to the transmitter.
3. The LVU-201A will now read in centimeters.

To change to inches

1. Remove power to the LVU-201A and wait 10 seconds.
2. Simultaneously press [∇] and [SET] while adding power to the transmitter.
3. The LVU-201A will now read in inches.

Configure the Sensor's Current Range using EC4 and EC20**EC4:**

1. Measure the distance from the bottom of the sensor to the desired EC4 set point.
2. Hold [MENU] key until EC4 appears in display.
3. Release [MENU] key and wait until a value appears.
 - a. The value that appears is the current distance from the sensor to the surface of the liquid.
4. Immediately press the [Δ] or [∇] keys to view the memory value for EC4.
5. Use the [Δ] or [∇] keys to raise or lower the display to the desired value.
 - a. If the keys remain untouched for more than 3 seconds, the sensor will exit the menu.
6. Press the [SET] key to enter this value as the new EC4 set point.

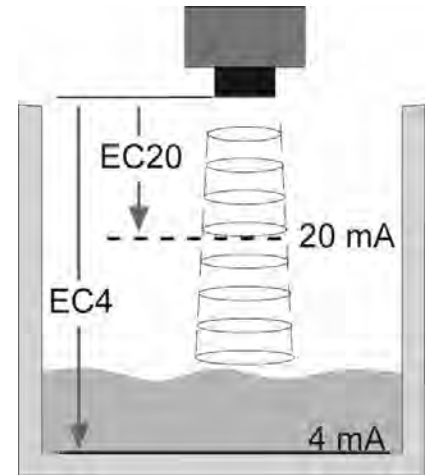
**EC20:**

1. Measure the distance from the bottom of the sensor to the desired EC20 set point.
2. Hold [MENU] key until EC20 appears in display.
3. Release [MENU] key and wait until a value appears.
 - a. The value that appears is the current distance from the sensor to the surface of the liquid.
4. Immediately press the [Δ] or [∇] keys to view the memory value for EC20.
5. Use the [Δ] or [∇] keys to raise or lower the display to the desired value.
 - a. If the keys remain untouched for more than 3 seconds, the sensor will exit the menu.
6. Press the [SET] key to enter this value as the new EC20 set point.

Set Operational Range using MAXR and MINR**MAXR:**

1. Measure the distance from the bottom of the sensor to the desired MAXR set point.
2. Hold [MENU] key until the value after MAXR appears in the display.
 - a. This value is the current MAXR setting.
3. If this is acceptable, press [SET] to lock the value as the MAXR setting. If not, use the [Δ] or [▽] keys to raise or lower the value to the desired setting.
4. Press the [SET] key to enter this value as the new MAXR setting.

MINR:

1. Measure the distance from the bottom of the sensor to the desired MINR set point.
2. Hold [MENU] key until the value after MINR appears in the display.
 - a. This value is the current MINR setting.
3. If this is acceptable, press [SET] to lock the value as the MINR setting. If not, use the [Δ] or [▽] keys to raise or lower the value to the desired setting.
4. Press the [SET] key to enter this value as the new MINR setting.

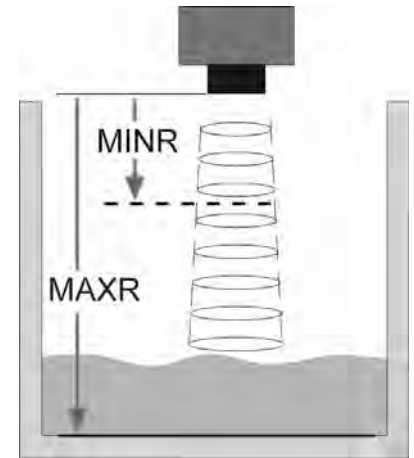
**Select the Fail-Safe Setting****SAF_:**

1. Hold [MENU] key until SAF1, SAF2, or SAF3 appears in the display.
2. Release [MENU] key and hold [SET] key to toggle between SAF1, SAF2 and SAF3.
3. When desired setting is reached, release [SET] key. The last display setting will be locked into memory.

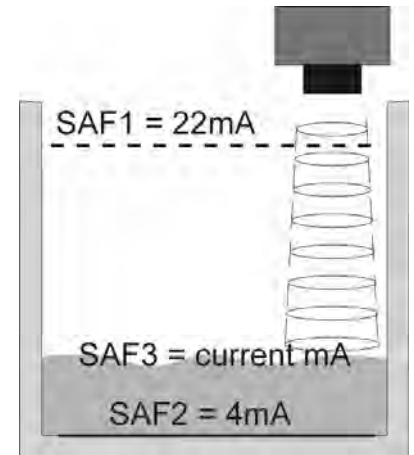

The LVU-201A requires 12-32 VDC power with at least with 25mA supply in order to operate.

Wiring to the LVCN-51 Level Controller:

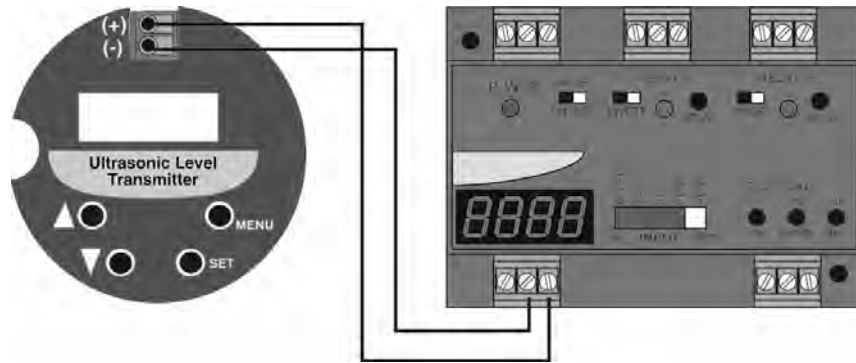

Wiring to a Generic Loop Powered Display:

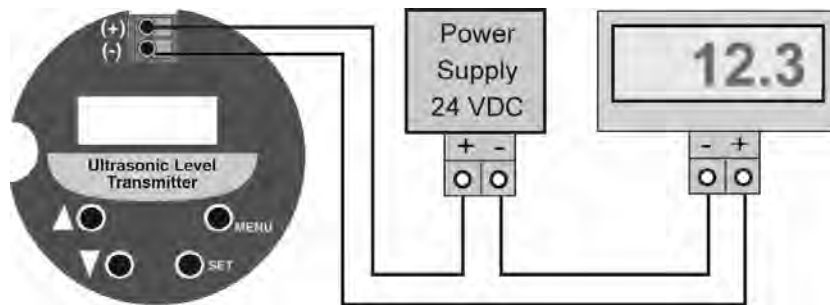

Wiring to a Generic PLC

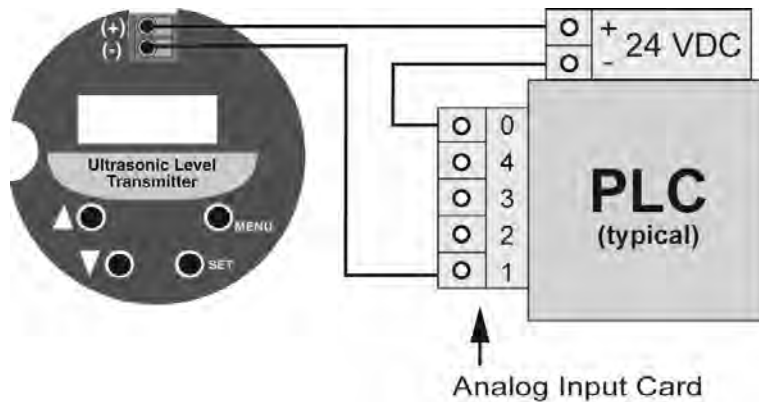

The LVU-201A should always be mounted perpendicular to the liquid. Make sure that the fitting and transmitter threads are not damaged or worn. Always *hand-tighten* the transmitter within the fitting. Perform an installed leak test under normal process conditions prior to system start up.

Mounting Guide

1. Do not mount at an angle
2. Liquid should never enter the dead band
3. Side Wall - Use the Beam Width data to find the closest the sensor can be to the side wall
4. Do not mount where obstacles will intrude on sensor's beam width
5. Do not mount in a vacuum
6. Avoid mounting in the center of a dome top tank.
7. In cone bottom tank, position the sensor over the deepest part of the tank.

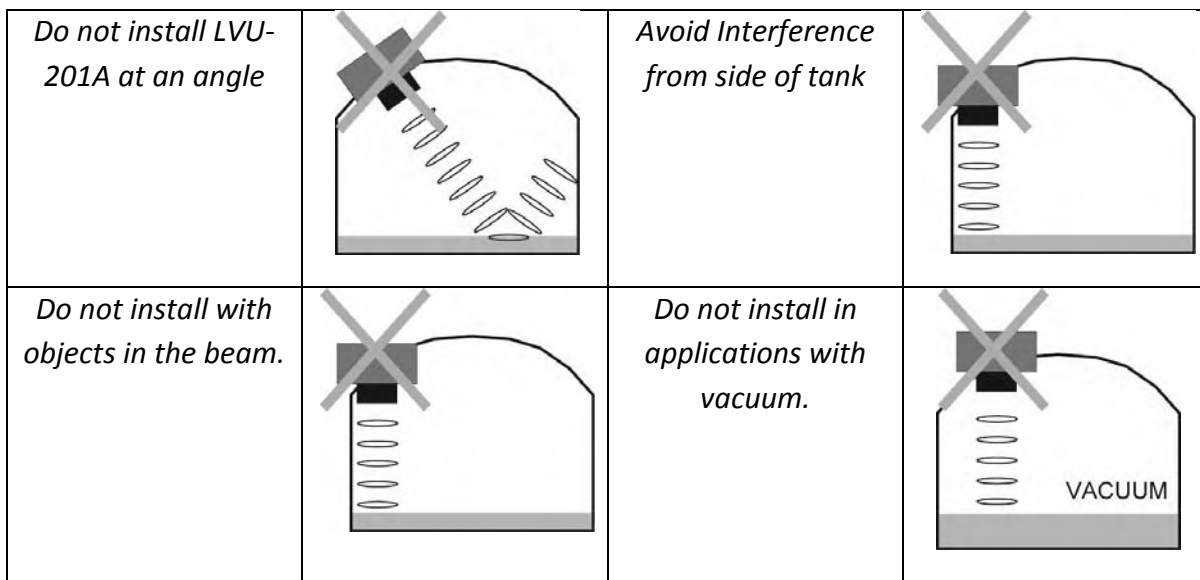

Installation in existing fittings: If the existing fitting is larger than the threads of the LVU-201A, select a reducer bushing such as LVU800-2N80 (3"thread x 2"thread) or LVU800-3N80 (4"thread x 2"thread).

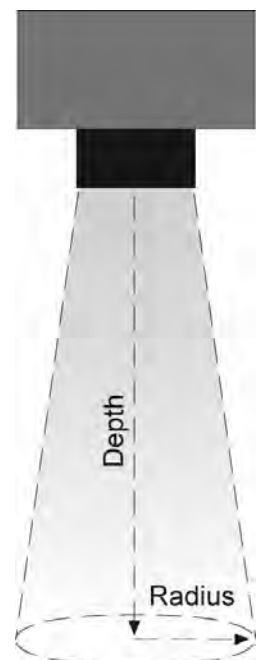

Beam Angle: LVU-201A features an 8° beam angle. As the distance to the liquid increases, the beam will increase in size. Keep any object that can interfere with the sound pulses outside of this beam angle. Use the data provided to size the footprint of the sound pulse.

Depth	Radius	Depth	Radius	Depth	Radius
1'	1.2"	7'	6.2"	13'	11.3"
2'	2.1"	8'	7.1"	14'	12.1"
3'	2.9"	9'	7.9"	15'	13.0"
4'	3.7"	10'	8.8"	16'	13.8"
5'	4.6"	11'	9.6"	17'	14.6"
6'	5.4"	12'	10.4"	18'	15.5"



Fitting Selection: LVU-201A is commonly installed in tank adapters, flanges, brackets or standpipes.

1. **Tank Adapter:** Select a tank adapter fitting, such as the LVU800-2B for the LVU-201A series.
 - a. Avoid tank adapter (thread x thread) styles and/or pipe stops forward of the installed transducer.
 - a. For larger tank adapters, it is OK to use a reducer bushing such as the LVU800-2N80 (3" thread x 2" thread).

2" Tank Adapter Socket x Thread	Tank Adapter Thread x Thread
	 <p data-bbox="1162 674 1511 705">Do not use thread x thread</p>

2. **Riser:** Installations with tall, narrow risers can impede the acoustic signal.
 - a. 2" (5 cm) diameter risers should be no taller than 3" (7.6 cm). Larger diameter risers should be no taller than 12" (30.5 cm).

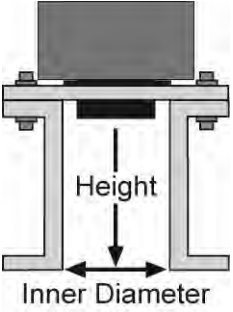
	Riser Specifications	
	Inner Diameter	Maximum Height
3" ~ (75mm)	3" ~ (75mm)	
4" ~ (100mm)	7" ~ (175mm)	
5" ~ (125mm)	10" ~ (250mm)	
6" ~ (150mm)	12" ~ (300mm)	
7" ~ (175mm)	14" ~ (350mm)	
8" ~ (200mm)	16" ~ (400mm)	

Note: Do not exceed the dimensions listed above

3. **Flange:** If installing on a flange, select a flange with a thread that is equal to the thread of the LVU-201A.
 - a. When using a flange with a riser, please observe the riser dimensional information above.
 - b. If the size of the flange is larger than the thread of the sensor, use a reducer bushing to help mount the sensor.

4. **Side Mount Bracket:** For installations in open tanks and sumps, use the LVM-30 series side mount bracket.
 - a. Be aware of the 8° beam angle with the LVU-201A transmitter.
 - b. Use the Beam Width data to avoid having the sensor's beam away from the side wall.

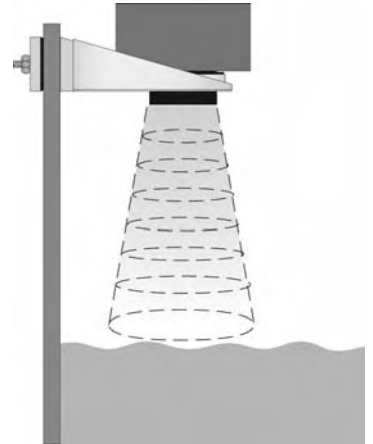

5. **Stand Pipe:** A standpipe may be used to dampen turbulence or when foam is present in the application.

- a. Pipe can be made of any material.
- b. Select a minimum 2" ID pipe for the stand pipe.
 - i. A larger diameter pipe can be used.
- c. Use a coupling and reducer bushing to attach the LVU-201A to the pipe.
- d. The pipe length should run the measurement span and the bottom of the pipe should remain submerged at all times to prevent foam from entering the pipe.
- e. The pipe must be a continuous length with no joints, couplings or extensions.
- f. Cut a 45° notch at the bottom of the pipe and drill a 1/4" pressure equalization hole in the dead band.
 - i. The vent hole must be within the dead band of the LVU-201A.
- g. The pumps should not drive liquid past the open end of the stand pipe which causes the liquid in the pipe to oscillate.

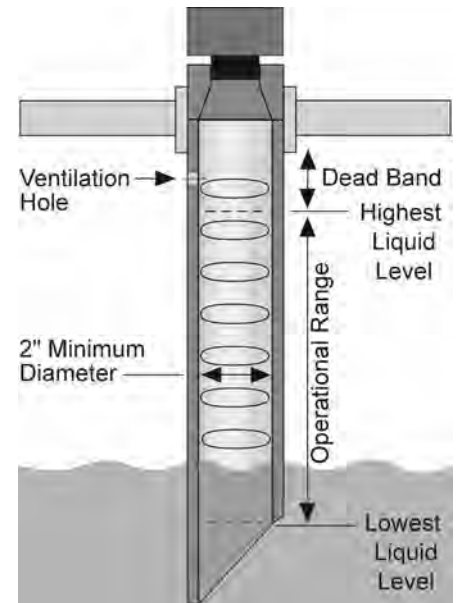

Return to Factory Setting: The LVU-201A is preset at time of shipment with the Factory Settings listed below. If at any time you need to return to the Factory Settings, remove power from the LVU-201A and wait 10 seconds. Press the [MENU] and [SET] buttons simultaneously while powering up the transmitter. **Note:** If power is cycled on and off or removed for a long duration of time, the configuration will not change. The only way to return to Factory Settings is to hold both the [MENU] and [SET] buttons while applying power.

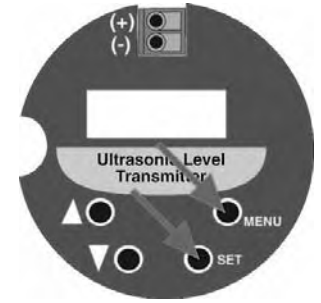

Factory Settings:

EC4	216" (548.4cm)	ON/OFF	OFF
EC20	8" (20.3cm)	MAXR	N/A
SAF1/2/3	SAF1	value	216" (548.6cm)
FAST/SLOW	FAST	MINR	N/A
ALIN	N/A	value	8" (20.3cm)

Changing Display Units: The LVU-201A comes preset to measure in inches (default setting). To change the display to show centimeters or to return to inches, flow the steps below. **Note:** If power is removed, the sensor will remain in the selected mode.

To change to centimeters

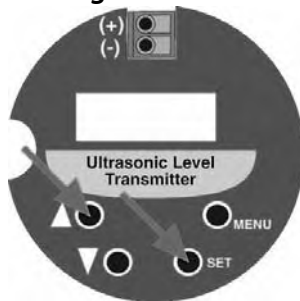

1. Remove power to the LVU-201A and wait 10 seconds.
2. Simultaneously press [Δ] and [SET] while adding power to the transmitter.
3. The LVU-201A will now read in centimeters.

To change to inches

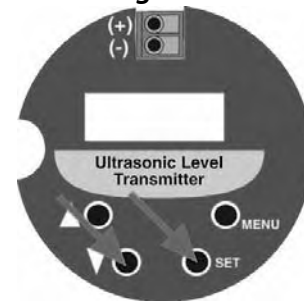

1. Remove power to the LVU-201A and wait 10 seconds.
2. Simultaneously press [∇] and [SET] while adding power to the transmitter.
3. The LVU-201A will now read in inches.

PROBLEM	SOLUTION
Transmitter outputs current of 0 mA	Check the wiring for an open circuit. An open circuit is the most common issue with a 0 mA signal
Transmitter jumps to a current output between 19 and 20 mA	Check the installation of the transmitter. Bad installation fittings will cause false signals near the top of the tank, which typically translates to a signal between 19 and 20 mA. Also look for interference just below the transmitter.
Transmitter outputs a current over 22 mA	Immediately check the wiring for a short circuit. The LVU-201A is current limited to 22 mA. Anything above 22 mA indicates a short circuit.
Transmitter always jumps to LOST condition	<p>A reading of LOST in the display of the LVU-201A indicates the transmitter is not receiving a valid return signal. If LOST appears, please check the following troubleshooting items:</p> <ol style="list-style-type: none"> 1. Beam cone interference such as the side wall, ladder, seams, rungs or pipes within the LVU-201A's beam cone. 2. Proper installation such that the LVU-201A is installed level and free from interference from the installation fitting or flange. 3. Sufficient power being supplied to the LVU-201A. The LVU-201A requires 12-32 VDC with a minimum supply of 25mA. 4. Proper Programming of the MAXR or MINR function. For best results, set the MAXR function as the distance from the bottom of the tank to the bottom of the transmitter. Also set the MINR distance above the highest level in the tank. Do not set the MINR to less than 6 inches. 5. Make sure that the transmitter is not installed at an angle. Even a 5 degree offset can reduce the signal return strength greatly.
Output of transmitter is opposite of the level of liquid	Check the EC4 & EC20 Setting. For 4mA at empty tank and 20 mA at full tank, the EC4 must be the larger value and the EC20 to smaller value. For 20mA at empty tank and 4 mA at full tank, the EC20 must be the larger value and the EC4 to smaller value.

PROBLEM	SOLUTION
The display on the transmitter does not match the display on the side of the tank	The display for the LVU-201A will always show the distance from the liquid surface to the bottom of the sensor (in inches or cm). The 4-20 mA output can be scaled to read in any engineering units, thus the displays will never match unless the local display is configured to read the air gap in the tank.
Sensor appears to have reset itself	<p>Check the settings for EC4 & EC20. <i>Remember that the first value seen in EC4 & EC20 is the current distance from the sensor to the liquid.</i></p> <ol style="list-style-type: none"> 1. To check EC4 setting: <ol style="list-style-type: none"> a. Press MENU until EC4 appears. b. Wait until a number appears. c. Immediately press the Δ button & the EC4 setting will appear. 2. To check EC20 setting: <ol style="list-style-type: none"> a. Press MENU until EC20 appears. b. Wait until a number appears. c. Immediately press the Δ button & the EC20 setting will appear.
Display reads CM8Q or CM8O	These are actually firmware codes for the sensor. The appearance of either code indicates that the sensor is stuck in a reboot stage due to the power flickering on and off. Check that the power being supplied is consistent and does not flicker off. Also check the wire connections at the terminals.

Other Hints: Current must change with all level movement. Example: For the illustration below, as level increases, the current output will increase. If the output of the LVU-201A is always reading 4mA or 20mA, check the input values for the LVU-201A.

The display on the LVU-201A will always indicate the distance from the bottom of the sensor to the surface of the liquid. As the liquid level increases, the value on the display will decrease. As the liquid level decreases, the value on the display will increase.

Testing the Transmitter

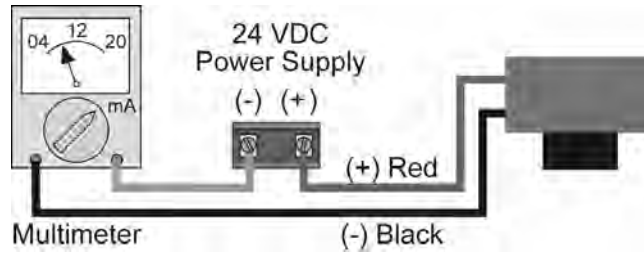

1. If installed in a classified area, remove the sensor from the hazardous location before testing.
2. Connect a multimeter in series with the black wire to read the current output.
3. Verify that the current increases (tank filling) and decreases (tank emptying) appropriately in the calibrated span.

If not, carefully observe and attempt to correlate any installation, level or application event for more specific troubleshooting direction.

User Settings:

Fill out the chart below and keep as a record of your configuration.

Current Range

EC 4 =	EC20 =
--------	--------

Loop Fail-Safe (select one)

SAF1 (22 mA)	SAF2 (4mA)	SAF3 (Hold Last Value)
--------------	------------	------------------------

Operation Range

MINR =	MAXR =
--------	--------



WARRANTY/DISCLAIMER

OMEGA ENGINEERING, INC. warrants this unit to be free of defects in materials and workmanship for a period of **13 months** from date of purchase. OMEGA's WARRANTY adds an additional one (1) month grace period to the normal **one (1) year product warranty** to cover handling and shipping time. This ensures that OMEGA's customers receive maximum coverage on each product.

If the unit malfunctions, it must be returned to the factory for evaluation. OMEGA's Customer Service Department will issue an Authorized Return (AR) number immediately upon phone or written request. Upon examination by OMEGA, if the unit is found to be defective, it will be repaired or replaced at no charge. OMEGA's WARRANTY does not apply to defects resulting from any action of the purchaser, including but not limited to mishandling, improper interfacing, operation outside of design limits, improper repair, or unauthorized modification. This WARRANTY is VOID if the unit shows evidence of having been tampered with or shows evidence of having been damaged as a result of excessive corrosion; or current, heat, moisture or vibration; improper specification; misapplication; misuse or other operating conditions outside of OMEGA's control. Components in which wear is not warranted, include but are not limited to contact points, fuses, and triacs.

OMEGA is pleased to offer suggestions on the use of its various products. However, OMEGA neither assumes responsibility for any omissions or errors nor assumes liability for any damages that result from the use of its products in accordance with information provided by OMEGA, either verbal or written. OMEGA warrants only that the parts manufactured by the company will be as specified and free of defects. OMEGA MAKES NO OTHER WARRANTIES OR REPRESENTATIONS OF ANY KIND WHATSOEVER, EXPRESSED OR IMPLIED, EXCEPT THAT OF TITLE, AND ALL IMPLIED WARRANTIES INCLUDING ANY WARRANTY OF MERCHANTABILITY AND FITNESS FOR A PARTICULAR PURPOSE ARE HEREBY DISCLAIMED. LIMITATION OF LIABILITY: The remedies of purchaser set forth herein are exclusive, and the total liability of OMEGA with respect to this order, whether based on contract, warranty, negligence, indemnification, strict liability or otherwise, shall not exceed the purchase price of the component upon which liability is based. In no event shall OMEGA be liable for consequential, incidental or special damages.

CONDITIONS: Equipment sold by OMEGA is not intended to be used, nor shall it be used: (1) as a "Basic Component" under 10 CFR 21 (NRC), used in or with any nuclear installation or activity; or (2) in medical applications or used on humans. Should any Product(s) be used in or with any nuclear installation or activity, medical application, used on humans, or misused in any way, OMEGA assumes no responsibility as set forth in our basic WARRANTY/DISCLAIMER language, and, additionally, purchaser will indemnify OMEGA and hold OMEGA harmless from any liability or damage whatsoever arising out of the use of the Product(s) in such a manner.

RETURN REQUESTS/INQUIRIES

Direct all warranty and repair requests/inquiries to the OMEGA Customer Service Department. BEFORE RETURNING ANY PRODUCT(S) TO OMEGA, PURCHASER MUST OBTAIN AN AUTHORIZED RETURN (AR) NUMBER FROM OMEGA'S CUSTOMER SERVICE DEPARTMENT (IN ORDER TO AVOID PROCESSING DELAYS). The assigned AR number should then be marked on the outside of the return package and on any correspondence.

The purchaser is responsible for shipping charges, freight, insurance and proper packaging to prevent breakage in transit.

FOR **WARRANTY** RETURNS, please have the following information available BEFORE contacting OMEGA:

1. Purchase Order number under which the product was PURCHASED,
2. Model and serial number of the product under warranty, and
3. Repair instructions and/or specific problems relative to the product.

FOR **NON-WARRANTY** REPAIRS, consult OMEGA for current repair charges. Have the following information available BEFORE contacting OMEGA:

1. Purchase Order number to cover the COST of the repair,
2. Model and serial number of the product, and
3. Repair instructions and/or specific problems relative to the product.

OMEGA's policy is to make running changes, not model changes, whenever an improvement is possible. This affords our customers the latest in technology and engineering.

OMEGA is a registered trademark of OMEGA ENGINEERING, INC.

© Copyright 2009 OMEGA ENGINEERING, INC. All rights reserved. This document may not be copied, photocopied, reproduced, translated, or reduced to any electronic medium or machine-readable form, in whole or in part, without the prior written consent of OMEGA ENGINEERING, INC.

Where Do I Find Everything I Need for Process Measurement and Control?

OMEGA...Of Course!

Shop online at omega.comSM

TEMPERATURE

- M Thermocouple, RTD & Thermistor Probes, Connectors, Panels & Assemblies
- M Wire: Thermocouple, RTD & Thermistor
- M Calibrators & Ice Point References
- M Recorders, Controllers & Process Monitors
- M Infrared Pyrometers

PRESSURE, STRAIN AND FORCE

- M Transducers & Strain Gages
- M Load Cells & Pressure Gages
- M Displacement Transducers
- M Instrumentation & Accessories

FLOW/LEVEL

- M Rotameters, Gas Mass Flowmeters & Flow Computers
- M Air Velocity Indicators
- M Turbine/Paddlewheel Systems
- M Totalizers & Batch Controllers

pH/CONDUCTIVITY

- M pH Electrodes, Testers & Accessories
- M Benchtop/Laboratory Meters
- M Controllers, Calibrators, Simulators & Pumps
- M Industrial pH & Conductivity Equipment

DATA ACQUISITION

- M Data Acquisition & Engineering Software
- M Communications-Based Acquisition Systems
- M Plug-in Cards for Apple, IBM & Compatibles
- M Datalogging Systems
- M Recorders, Printers & Plotters

HEATERS

- M Heating Cable
- M Cartridge & Strip Heaters
- M Immersion & Band Heaters
- M Flexible Heaters
- M Laboratory Heaters

ENVIRONMENTAL MONITORING AND CONTROL

- M Metering & Control Instrumentation
- M Refractometers
- M Pumps & Tubing
- M Air, Soil & Water Monitors
- M Industrial Water & Wastewater Treatment
- M pH, Conductivity & Dissolved Oxygen Instruments