

**.2 YEAR
WARRANTY**

**MADE IN
USA**

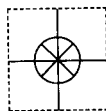

User's Guide

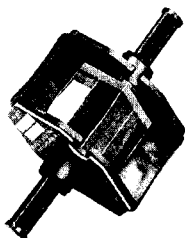
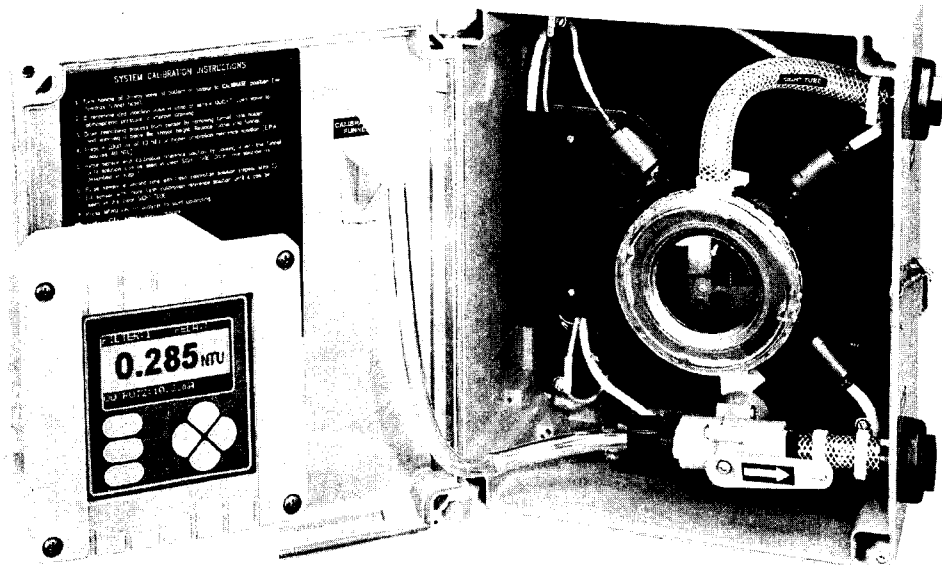

Shop online at

omega.com®

Ω OMEGA®

www.omega.com

e-mail: info@omega.com

ISO 9001
CERTIFIED
CORPORATE QUALITY

STAMFORD, CT

ISO 9002
CERTIFIED
CORPORATE QUALITY

MANCHESTER, UK

TRCN-96 Turbidity Meter System



OMEGAnet® Online Service www.omega.com	Internet e-mail info@omega.com
---	---

Servicing North America:

USA: One Omega Drive, P.O. Box 4047
ISO 9001 Certified Stamford CT 06907-0047
TEL: (203) 359-1660 FAX: (203) 359-7700
e-mail: info@omega.com

Canada: 976 Bergar
Laval (Quebec) H7L 5A1, Canada
TEL: (514) 856-6928 FAX: (514) 856-6886
e-mail: info@omega.ca

For immediate technical or application assistance:

USA and Canada: Sales Service: 1-800-826-6342 / 1-800-TC-OMEGA®
Customer Service: 1-800-622-2378 / 1-800-622-BEST®
Engineering Service: 1-800-872-9436 / 1-800-USA-WHEN®
TELEX: 996404 EASYLINK: 62968934 CABLE: OMEGA

Mexico: En Español: (001) 203-359-7803 e-mail: espanol@omega.com
FAX: (001) 203-359-7807 info@omega.com.mx

Servicing Europe:

Benelux: Postbus 8034, 1180 LA Amstelveen, The Netherlands
TEL: +31 (0)20 3472121 FAX: +31 (0)20 6434643
Toll Free in Benelux: 0800 0993344
e-mail: sales@omegaeng.nl

Czech Republic: Frystatska 184/46, 733 01 Karviná, Czech Republic
TEL: +420 (0)59 6311899 FAX: +420 (0)59 6311114
Toll Free: 0800-1-66342 e-mail: info@omegashop.cz

France: 11, rue Jacques Cartier, 78280 Guyancourt, France
TEL: +33 (0)1 61 37 29 00 FAX: +33 (0)1 30 57 54 27
Toll Free in France: 0800 466 342
e-mail: sales@omega.fr

Germany/Austria: Daimlerstrasse 26, D-75392 Deckenpfronn, Germany
TEL: +49 (0)7056 9398-0 FAX: +49 (0)7056 9398-29
Toll Free in Germany: 0800 639 7678
e-mail: info@omega.de

United Kingdom: One Omega Drive, River Bend Technology Centre
ISO 9002 Certified Northbank, Irlam, Manchester
M44 5BD United Kingdom
TEL: +44 (0)161 777 6611 FAX: +44 (0)161 777 6622
Toll Free in United Kingdom: 0800-488-488
e-mail: sales@omega.co.uk

It is the policy of OMEGA to comply with all worldwide safety and EMC/EMI regulations that apply. OMEGA is constantly pursuing certification of its products to the European New Approach Directives. OMEGA will add the CE mark to every appropriate device upon certification.

The information contained in this document is believed to be correct, but OMEGA Engineering, Inc. accepts no liability for any errors it contains, and reserves the right to alter specifications without notice.

WARNING: These products are not designed for use in, and should not be used for, human applications.

Manual M-3649

**TRCN-96 SYSTEM
LOW-RANGE
TURBIDITY METER SYSTEM**

(Model TRCN-96 Analyzer and TRCN-96 Sensor)

OPERATING INSTRUCTION MANUAL

TRCN-96 SYSTEM™ Low-range Turbidity Meter System

(Model TRCN-96 Analyzer and TRCN-96 Sensor)

IMPORTANT SAFETY INFORMATION

This measurement system is compliant with safety standards as outlined in:

FMRC Class Numbers 3600, 3611, and 3810 (U.S.A.)
CSA C22.2 No. 142 and C22.2 No. 213 (Canada)
EN 61010-1 (European Community)

Please read and observe the following:

- Opening the analyzer door exposes you to line power voltage, if present, at terminals on TB2 and TB3 inside the enclosure. This may be hazardous. Always remove line power before entering this area in the analyzer. However, the analyzer door assembly and the sensor contain only low voltages and are completely safe to handle.
- Wiring or repairs should only be performed by qualified personnel and only to an unpowered analyzer.
- Whenever it appears that analyzer safety is questionable, disable the analyzer to ensure against any unintended operation. For example, an unsafe condition is likely when:
 - 1) The analyzer appears visibly damaged.
 - 2) The analyzer fails to operate properly or provide the intended measurements.
 - 3) The analyzer has been stored for long periods at temperatures above 158°F (70°C).
- This measurement system must be installed by specially trained personnel in accordance with relevant local codes and instructions contained in this operating instruction manual. Observe all technical specifications of the system. If one line of the line power mains is not neutral, use a double-pole mains switch to disconnect the analyzer.

HELPFUL IDENTIFIERS

In addition to information on installation and operation, this instruction manual may contain **WARNINGS** pertaining to user safety, **CAUTIONS** regarding possible instrument malfunction, and **NOTES** on important, useful operating guidelines.

WARNING:

A WARNING LOOKS LIKE THIS. IT WARNS YOU OF THE POTENTIAL FOR PERSONAL INJURY.

CAUTION:

A CAUTION LOOKS LIKE THIS. IT ALERTS YOU TO POSSIBLE INSTRUMENT MALFUNCTION OR DAMAGE.

NOTE: A note looks like this. It alerts you to important operating information.

Definition of Equipment Symbols



This symbol means **CAUTION** and alerts you to possible danger or instrument malfunction. Refer to this manual before proceeding.



This symbol means that this is a **protective ground terminal** and alerts you to connect an earth ground to it.



This symbol means that there is **alternating current present** and alerts you to be careful.

CONDENSED OPERATING INSTRUCTIONS

This manual contains details for all operating aspects of the TRCN-96 SYSTEM™ Low-range Turbidity Meter System. The following condensed instructions are provided to assist you in getting the system started up and operating as quickly as possible. **These condensed instructions only pertain to basic turbidity measurement operation.** To use specific analyzer features, refer to the appropriate sections in this manual for instructions.

1. CONNECTING SENSOR

After the TRCN-96 analyzer is properly mounted (Part Two, Section 2.5), connect the Omega Engineering Model TRCN-96 Sensor low-range turbidity sensor, matching wire colors to terminals as indicated:

Sensor Wire Colors	Analyzers with "B" Prefix Serial No.	Analyzers with No Letter Prefix Serial No.
Inner Shield	Grounding strip lug	Terminal #11 on TB1
Red	Terminal #12 on TB1	Terminal #12 on TB1
Violet	Terminal #13 on TB1	Terminal #13 on TB1
Green	Terminal #14 on TB1	Terminal #14 on TB1
White	Terminal #15 on TB1	Terminal #15 on TB1
Yellow	Terminal #16 on TB1	Terminal #16 on TB1
Inner Shield	Grounding strip lug	Terminal #17 on TB1
Brown	Terminal #18 on TB1	Terminal #18 on TB1
Gray	Terminal #19 on TB1	Terminal #19 on TB1
Blue	Terminal #20 on TB1	Terminal #20 on TB1
Black	Terminal #21 on TB1	Terminal #21 on TB1
Orange	Terminal #22 on TB1	Terminal #22 on TB1

2. CONNECTING LINE POWER

Important: Follow the instructions in Part Two, Section 3.5 to connect line power to the analyzer.

3. ADJUSTING DISPLAY CONTRAST

Ambient lighting conditions may make it necessary to adjust display contrast to improve visibility. With the MEASURE screen displayed, press and hold the **ENTER** key and simultaneously press the \uparrow or \downarrow key until attaining the desired contrast.

4. CALIBRATING SYSTEM

Always initially calibrate the TRCN-96 SYSTEM™ Low-range Turbidity Meter System to ensure accurate measurement. Any time thereafter, you can conveniently check system calibration using an optional accessory TR-8220 calibration standard cube.

- **When you need to calibrate with a primary standard**, use the "PRIMARY CAL" calibration method. Omega Engineering only guarantees measurement accuracy when a 40 NTU formazin suspension is used as the primary standard.
- **When calibration need not conform to USEPA requirements**, use the calibration standard cube method (requires optional TR-8220) or the "SAMPLE CAL" method.

Refer to Part Three, Section 5 for instructions on all calibration methods.

5. COMPLETING ANALYZER CONFIGURATION

To further configure the analyzer to your application requirements, use the appropriate CONFIGURE screens to make selections and "key in" values. Refer to Part Three, Section 4 for complete configuration details.

TABLE OF CONTENTS

PART ONE - INTRODUCTION

SECTION 1	GENERAL INFORMATION	
	1.1 Capability Highlights.....	9-11
	1.2 Modular Construction.....	11
	1.3 Retained Configuration Values.....	11
	1.4 Analyzer and Sensor Serial Numbers.....	11
	1.5 EMI/RFI Immunity.....	12
SECTION 2	SPECIFICATIONS.....	13-14

PART TWO - INSTALLATION

SECTION 1	UNPACKING.....	15
SECTION 2	MECHANICAL REQUIREMENTS	
	2.1 Sensor Location.....	15-16
	2.2 Sensor Mounting.....	16-17
	2.3 Sensor Plumbing Connections.....	18
	2.4 Analyzer Location.....	19
	2.5 Analyzer Mounting.....	19-20
	2.6 Sensor and Analyzer Conduit Hole Requirements.....	20
SECTION 3	ELECTRICAL CONNECTIONS	
	3.1 Omega Engineering Model TRCN-96 Sensor Low-range Turbidity Sensor.....	21-23
	3.2 Analog Outputs.....	24
	3.3 Relay Outputs.....	24-25
	3.4 Closed Contact TTL Input.....	25
	3.5 Line Power.....	26-27

PART THREE - OPERATION

SECTION 1	USER INTERFACE	
	1.1 Display.....	28
	1.2 Keypad.....	28-29
	1.3 MEASURE Screen (normal display mode).....	30
SECTION 2	MENU STRUCTURE	
	2.1 Displaying Main Branch Selection Screen.....	31
	2.2 Displaying Top-level Menu Screens.....	31-32
	2.3 Displaying Submenu Screens.....	32
	2.4 Adjusting Edit/Selection Screen Values.....	32-33
	2.5 Entering (Storing) Edit/Selection Screen Values/Choices.....	33

TABLE OF CONTENTS (continued)

SECTION 3	ADJUSTING DISPLAY CONTRAST	33
SECTION 4	CONFIGURING THE ANALYZER	
4.1	Selecting LANGUAGE to Operate Analyzer.....	34
4.2	Configuring Sensor Characteristics:	
	SELECT UNITS	34-35
	SET FILTER Time	35
	Select PULSE SUPPRESS (on/off)	36
	ENTER NOTE (top line of MEASURE screen)	36
4.3	Configuring Analog Outputs (1 and 2):	
	SET 0/4 and 20 mA VALUES	37-38
	SET TRANSFER Value (mA)	38
	SET FILTER Time	39
	Select SCALE 0 mA/4 mA (low endpoint).....	39
4.4	Configuring Relays (A, B, C, and D):	
	SET FUNCTION Mode (alarm, control, or status)	40-41
	SET TRANSFER Mode (relay on or off)	42
	SET ACTIVATION (configuration values)	42-44
4.5	SET PASSCODE (feature enabled or disabled)	44
4.6	Configuration Settings Summary (ranges/choices and defaults)	45
SECTION 5	CALIBRATING THE ANALYZER	
5.1	Things to Know About Calibration	46-47
5.2	PRIMARY CAL Method (requires formazin suspension):	
	Preparing Formazin Solution	47-48
	Filling Sensor	48-50
	Entering Value	50
	Resuming Operation	50-51
5.3	CALIBRATION STANDARD CUBE Method (requires optional TR-8220):	
	Inserting TR-8220	51-52
	Entering Value	52-53
	Resuming Operation	53
5.4	SAMPLE CAL Method (requires sample with value determined by laboratory analysis or portable meter)	53-55
5.5	Analog Outputs (1 and 2) Calibration	55-56
SECTION 6	TEST/MAINTENANCE	
6.1	STATUS Checking (analyzer, sensor, and relays)	57-59
6.2	CHECK CAL/HOLD Outputs	59-60
6.3	OVERFEED RESET (relay timers).....	61
6.4	OUTPUT (1 and 2) Analog Test Signals	61-62
6.5	RELAY (A, B, C, and D) Operating Test	62
6.6	SENSOR TYPE Checking.....	62-63
6.7	EPROM VERSION Checking.....	63

TABLE OF CONTENTS (continued)

	6.8 SIM SENSOR Setting	63-64
	6.9 RESET DEFAULTS	64
SECTION 7	RELAY OVERFEED TIMER FEATURE	
	7.1 Why Use an Overfeed Timer	65
	7.2 Configuring Relay Overfeed Timers	65
	7.3 Overfeed Timer "Timeout" Operation	65
	7.4 Resetting Overfeed Timers	65
	7.5 Interactions with Other Analyzer Functions	65-66

PART FOUR - SERVICE AND MAINTENANCE

SECTION 1	GENERAL INFORMATION	
	1.1 Cleaning Sensor Flow Chamber	67-68
	1.2 Cleaning Optional TR-8220.....	68
	1.3 Replacing Sensor Light Source or Detector:	
	Removing Inoperative Part	69
	Installing New Part	69-70
	Re-calibrating Measurement System.....	70
	1.4 Replacing Fuse(s)	71
	1.5 Replacing Relays	71
	1.6 Inspecting Sensor Cable	71
SECTION 2	PRESERVING MEASUREMENT ACCURACY	
	2.1 Eliminating Bubbles in Sensor Flow Chamber:	
	Restricting Sensor Outlet.....	72
	Using an External Bubble Trap	72
	2.2 Keeping Sensor Flow Chamber Clean	73
	2.3 Keeping System Calibrated.....	73
	2.4 Avoiding Electrical Interference.....	74
SECTION 3	TROUBLESHOOTING	
	3.1 System Diagnostic Condition Messages	74
	3.2 Isolating the Problem:	
	Checking Electrical Connections	76
	Checking Operation Using System Diagnostics.....	76
SECTION 4	ANALYZER REPAIR/RETURN	
	4.1 Customer Assistance	77
	4.2 Repair/Return Policy	77

TABLE OF CONTENTS (continued)

ILLUSTRATIONS

Figure 1-1	EMI/RFI Immunity Diagram	12
Figure 2-1	Recommended Closed-loop Sensor Piping Arrangement	15
Figure 2-2	Recommended Sample Bypass Line Sensor Piping Arrangement.....	16
Figure 2-3	Standard Design Model TRCN-96 Sensor -- Installation Dimension Details.....	17
Figure 2-4	High Pressure Design Model TRCN-96 Sensor -- Installation Dimension Details	17
Figure 2-5	Sampling Point Guidelines for Process Pipe Plumbing Connection.....	18
Figure 2-6	Analyzer Mounting Arrangements	19
Figure 2-7	Analyzer Installation Dimension Details.....	20
Figure 2-8	Terminal Block Designations for Analyzers with "B" Prefix Serial Number	22
Figure 2-9	Terminal Block Designations for Analyzers with No Letter Prefix Serial Number	22
Figure 2-10	Connecting Model TRCN-96 Sensor Low-range Turbidity Sensor to Analyzers with "B" Prefix Serial Number	23
Figure 2-11	Connecting Model TRCN-96 Sensor Low-range Turbidity Sensor to Analyzers with No Letter Prefix Serial Number	23
Figure 2-12	Connecting Control/Alarm Device(s) to Electromechanical Relay(s)	25
Figure 2-13	Connecting 115 V Single Phase to Analyzers with "B" Prefix Serial Number.....	26
Figure 2-14	Connecting 115 V Single Phase to Analyzers with No Letter Prefix Serial Number.....	26
Figure 2-15	Connecting 230 V Single Phase to Analyzers with "B" Prefix Serial Number.....	27
Figure 2-16	Connecting 230 V Single Phase to Analyzers with No Letter Prefix Serial Number.....	27
Figure 2-17	Connecting 230 V Split Phase to Analyzers with "B" Prefix Serial Number.....	27
Figure 2-18	Connecting 230 V Split Phase to Analyzers with No Letter Prefix Serial Number.....	27
Figure 3-1	Analyzer Keypad.....	29
Figure 4-1	Standard Design Sensor -- Component Details	67
Figure 4-2	High Pressure Design Sensor -- Component Details	68
Figure 4-3	Turbidity Sensor Terminal Block Designations.....	70

TABLES

Table A	Relay Configuration Settings	42-43
Table B	Analyzer Configuration Settings (Ranges/Choices and Defaults)	45
Table C	Relay Overfeed Timer Interactions with Other Analyzer Functions.....	66
Table D	System Diagnostic Condition Status Screens/Meanings.....	75

PART ONE - INTRODUCTION

SECTION 1

GENERAL INFORMATION

1.1 Capability Highlights

High Accuracy with
Minimal Maintenance

The TRCN-96 SYSTEM™ Low-range Turbidity Meter System employs a technologically-advanced sensor to provide high measurement accuracy and stability, while reducing maintenance requirements. It is designed to meet the International Standards For Measurement of Turbidity [ISO 7027-1984(E)] and USEPA-approved Omega Engineering Method 2. This system has an auto-ranging measuring scale, enabling continuous monitoring over a 0.000-100.0 NTU range with automatic decimal point positioning. **The TRCN-96 SYSTEM™ Low-range Turbidity Meter System automatically provides increasing display resolution as measured turbidity decreases.** To further ensure high measuring accuracy, the Model TRCN-96 Sensor eliminates air or gas bubbles in the sample with its built-in bubble trap. The system is ideal for critical monitoring and controlling applications including potable water, filtered water, and final product clarity.

MEASURE Screen

With the display in the normal MEASURE screen mode, the measured turbidity is always shown on the main middle line. The bottom auxiliary display line, shown in reverse video, can be changed by pressing the ↓ and ↑ keys to show these measurements:

- Analog Output 1 value (mA)
- Analog Output 2 value (mA)

Passcode-protected
Access

For security, you can enable a passcode feature to restrict access to configuration and calibration settings to authorized personnel only. See Part Three, Section 4.5 for details.

Calibration Methods

Three methods are available to calibrate the system. See Part Three, Section 5.1 for details. **With the optional TR-8220, you can conveniently check calibration any time (Section 6.2).** The mA value for each analog output can also be calibrated (Section 5.5).

Analog Outputs

The analyzer provides two isolated analog outputs (1 and 2). Each output represents the measured turbidity, and can be set to be 0-20 mA or 4-20 mA.

Turbidity values can be entered to define endpoints at which the minimum and maximum analog output values are desired.

During calibration, both analog outputs can be selected to:

- Hold their present values (HOLD OUTPUTS).
- Transfer to preset values to operate control elements by an amount corresponding to those values (XFER OUTPUTS).
- Remain active to respond to the measured turbidity (ACTIVE OUTPUTS).

For complete analog output setup details, including transfer setup, refer to Part Three, Section 4.3.

Relays

The analyzer has four electromechanical relays with SPDT contacts. Each relay can be set to function as a CONTROL, ALARM (dual-alarm), or STATUS relay. CONTROL and ALARM relays operate in response to the measured turbidity. STATUS relays operate only in response to selected system diagnostic conditions.



NOTE: *Relay D is factory-set to function as a STATUS relay but can be configured as a CONTROL or ALARM relay.*

When a relay is set to function as a STATUS relay, it becomes a dedicated system diagnostic-only alarm relay. A STATUS relay can be configured for:

- FAIL mode -- sets STATUS relay to activate when there is a FAIL condition (analyzer, light source or detector) or a sensor CHAMBER UNKNOWN condition.
- WARN mode -- sets STATUS relay to activate only when there is a sensor flow CHAMBER DIRTY condition.
- ALL mode -- sets STATUS relay to activate when there is any abnormal system condition (any FAIL condition, or sensor CHAMBER DIRTY or UNKNOWN condition).

A "WARNING CHECK STATUS" message automatically flashes on the MEASURE screen whenever the analyzer detects any of these system diagnostic conditions:

- ANALYZER FAIL
- CHAMBER DIRTY
- CHAMBER UNKNOWN
- SOURCE 1 FAIL
- SOURCE 2 FAIL
- DETECT 1 FAIL
- DETECT 2 FAIL

To determine the condition causing the warning message, display the "STATUS screens" in the TEST/MAINT menu branch. For more details, refer to Part Three, Section 6.1.

During calibration, CONTROL and ALARM relay on/off states are affected in the same way as the analog outputs by the "(HOLD/XFER/ACTIVE) OUTPUTS" screen selection. These relays are also held at their present on/off states, transferred to desired preset on/off states, or remain active to respond to measured turbidity. For complete relay setup details, including transfer setup, see Part Three, Section 4.4.

1.2 Modular Construction

The modular construction of the analyzer simplifies field servicing and provides electrical safety. The front door/ keypad assembly and the sensor use voltages no greater than 24 VDC, and are completely safe to handle.

Opening the analyzer door accesses terminals inside the enclosure for electrical connections. Line power must be connected to specifically designated terminals on TB3.

WARNING:

**REMOVE LINE POWER BEFORE NEARING THIS AREA
TO AVOID ELECTRICAL SHOCK.**

1.3 Retained Configuration Values

All user-entered configuration values are retained indefinitely, even if power is lost or turned off. The non-volatile analyzer memory does not require battery backup.

1.4 Analyzer and Sensor Serial Numbers

A label with the analyzer model number, serial number, build date, and other items is affixed to the top of the analyzer enclosure. A similar label is affixed to the sensor.

1.5 EMI/RFI Immunity

The analyzer is designed to provide protection from most normally encountered electromagnetic interference. This protection exceeds U.S. standards and meets European IEC 801-series testing for electromagnetic and radio frequency emissions and susceptibility. Refer to Figure 1-1 and the specifications in Section 2.2 for more information.

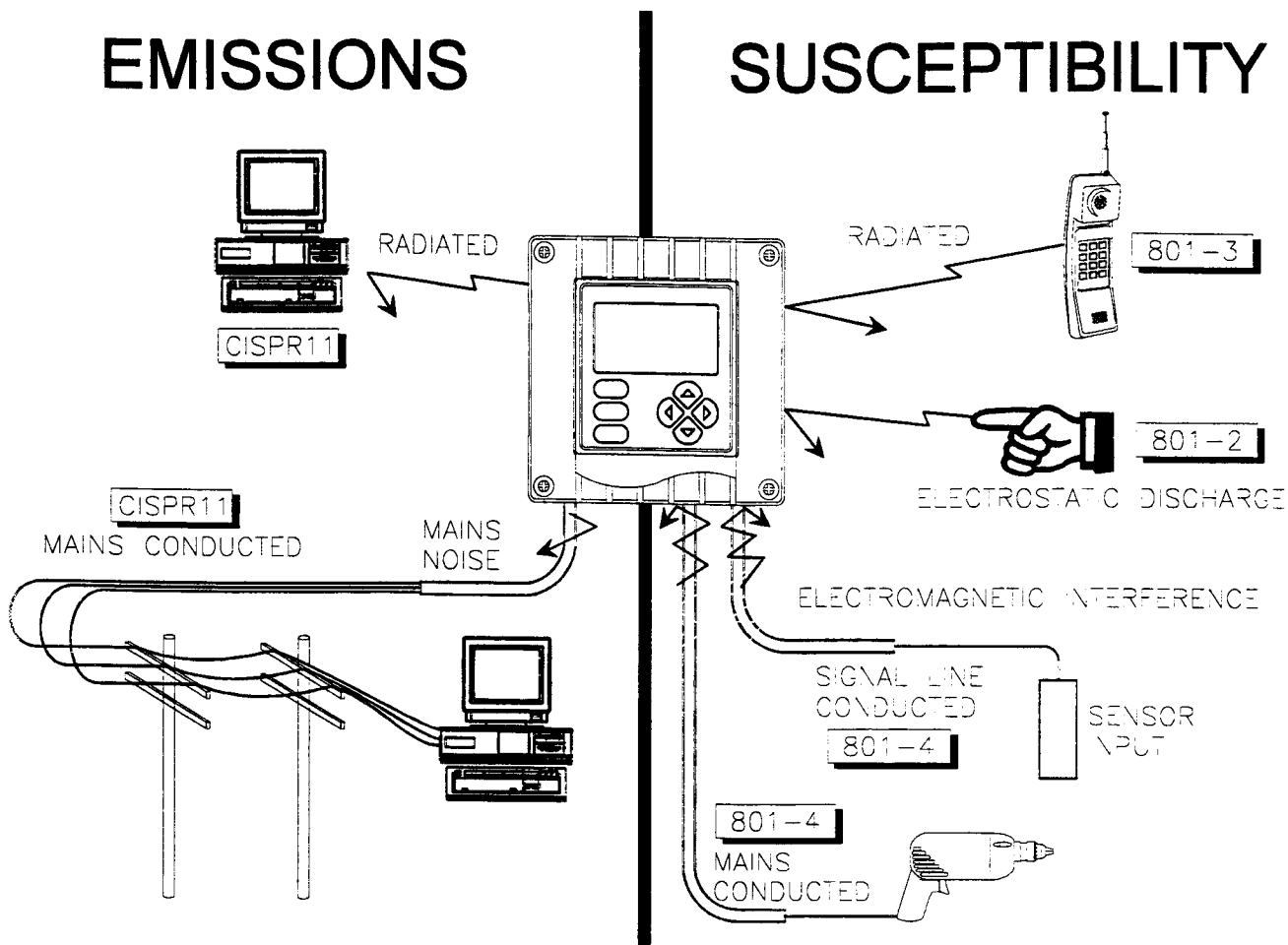

FIGURE 1-1 EMI/RFI Immunity Diagram

SECTION 2

SPECIFICATIONS

2.1 Model TRCN-96 Sensor Low-range

Turbidity Sensor Operational

Flow Rate.....	0.05 to 7 GPM (0.19 to 26.5 LPM)
Ambient Conditions.....	32-140°F (0-60°C)
Sample Temperature Range	32-140°F (0-60°C)
Pressure Range:	
Standard Sensor Design	0-50 psig at 68°F (0-3.4 bar at 20°C)
High Pressure Design	0-150 psig at 68°F (0-10.2 bar at 20°C)
Pressure Drop:	
Standard Sensor Design	0.0017 psig at 0.1 GPM (0.0001 bar at 0.36 LPM)
High Pressure Design	0.165 psig at 1.0 GPM (0.012 bar at 3.8 LPM)
Residence Time.....	9.5 seconds at 1 GPM (3.8 LPM)
Air Venting	Integral bubble trap for 0.05 to 0.5 GPM (0.19 to 1.8 LPM) flows. Installation of restrictor valve on the sensor outlet is recommended for flows above 0.5 GPM (1.8 LPM) with air in sample.
Light Sources.....	Two near-infrared (860 nM wavelength) LEDs
Sensor Flow Configuration	Flow-through design
Process Connections.....	1/2 inch NPT female standard; adaptable to 3/8 inch or 1/4 inch NPT, barb or tube fittings
Wetted Materials.....	PVC, polycarbonate, polystyrene, PPO, nitrile, and Buna-N
Cleaning Method.....	Water rinse, wipe surfaces
Enclosure:	
Standard Sensor Design	NEMA 4X (≅ CSA type 4; ≅ IP65), molded and fiberglass-reinforced polyester (flame retardant) with four integral tabs for surface mounting
High Pressure Design	NEMA 4X (≅ CSA type 4; ≅ IP65), PPO structural foam (V-0 flammability rating per U.L. 94 test) with four integral tabs for surface mounting
Mounting Configurations.....	Surface or pipe mount
Net Weight.....	10 lbs. (4.5 kg) approximately

Mechanical

2.2 Model TRCN-96 Analyzer

Operational

Display	Graphic dot matrix LCD, 128 x 64 pixels with LED backlighting; 1/2 inch (13 mm) main character height; 1/8 inch (3mm) auxiliary information character height; menu screens contain up to six text lines
<u>Measurement</u>	<u>Auto-ranging Scale</u>
Turbidity.....	0.000-100.0 NTU with auto-ranging and decimal point shift above 1.000 NTU and 10.00 NTU (same for other measurement units)
mA Outputs (1 and 2)	0.00-20.00 mA or 4.00-20.00 mA
Ambient Conditions:	
Operation.....	-4 to +140°F (-20 to +60°C); 0-95% relative humidity, non-condensing
Storage.....	-22 to +158°F (-30 to +70°C); 0-95% relative humidity, non-condensing
Relays: Types/Outputs	Four electromechanical relays; SPDT (Form C) contacts; U.L. rated 5A 115/230 VAC, 5A @ 30 VDC resistive
Operational Mode.....	Each relay (A, B, C, and D) can be assigned to be driven by the measured turbidity or diagnostics
Function Modes:	
Control	Settings for high/low phasing, setpoint, dead-band, overfeed timer, off delay, and on delay

Alarm.....	Settings for low alarm point, low alarm point deadband, high alarm point, high alarm point deadband, off delay, and on delay
Status.....	Setting for FAIL, WARN or ALL system diagnostic conditions to activate relay when specific conditions exist (analyzer, light source 1/2 or detector 1/2 failure, sensor chamber dirty or sensor chamber unknown)
Indicators	Relay annunciators (A, B, C, and D) indicate respective relay on/off status
Sensor-to-Analyzer Distance	30 ft. (9 m) maximum (consult factory if longer distances are required)
Power Requirements	90-130 VAC, 50/60 Hz. (10 VA max.) or 180-260 VAC, 50/60 Hz. (10 VA max.)
Calibration Methods:	
PRIMARY	Enter one primary standard value (formazin suspension is recommended).
Calibration Standard Cube	Temporarily insert an optional TR-8220 into the sensor and enter its factory-certified standard value.
SAMPLE.....	Enter one sample value determined by laboratory analysis or calibrated portable meter.
Analog Outputs.....	Two isolated 0/4-20 mA outputs; each with 0.004 mA (12-bit) resolution and capability to drive up to 600 ohm loads
<i>NOTE: Each output represents the measured turbidity. Turbidity values can be entered to define the endpoints at which the minimum and maximum mA output values are desired. During calibration, both outputs can be selected to hold their present values, transfer to preset values to operate control elements by an amount corresponding to those values, or remain active to respond to the measured turbidity.</i>	
Communication: RS-232	Enables configuration and retrieval of measured data for one analyzer using an IBM-compatible PC and optional Omega Engineering software tool kit
Memory Backup (non-volatile)	All user settings are retained indefinitely in memory (EEPROM)
EMI/RFI Conformance	Meets European standards for conducted and radiated emissions and immunity; certified CE compliant for applications as specified by EN 50081-1 for emissions and EN 50082-2 for immunity
Electrical Certifications:	
General Purpose (pending).....	UL, C-UL, FM, and CENELEC
Division 2 (pending)	UL, C-UL, and FM: Groups A, B, C, D, F, and G
Zone 2 (pending).....	CENELEC: Group IIC
Enclosure.....	NEMA 4X; polycarbonate face panel, epoxy-coated cast aluminum door and case with four 1/2 inch (13 mm) conduit holes, nylon mounting bracket, and stainless hardware
Mounting Configurations	Panel, surface, and pipe mounting
Net Weight.....	5 lbs. (2.3 kg) approximately
System Accuracy	± 2% of reading, all ranges
Sensitivity.....	0.001 NTU
Repeatability	0.1% of span or better
Temperature Drift.....	Zero and Span: 0.01% of span per °C

Mechanical

2.3 TRCN-96 SYSTEM™ Turbidity Meter System Performance (electrical, analog outputs)

PART TWO - INSTALLATION

SECTION 1

UNPACKING

After unpacking, it is recommended to save the shipping carton and packing materials in case the instrument must be stored or re-shipped. Inspect the equipment and packing materials for signs of shipping damage. If there is any evidence of damage, notify the transit carrier immediately.

SECTION 2

MECHANICAL REQUIREMENTS

2.1 Sensor Location

Locate the Model TRCN-96 Sensor turbidity sensor indoors or outdoors within 30 ft. (9 m) of where the Model TRCN-96 analyzer is to be installed. The sensor may be installed in an "in line" process configuration using a closed loop piping arrangement (Figure 2-1) or in a sample bypass line configuration using an open drain piping arrangement (Figure 2-2).

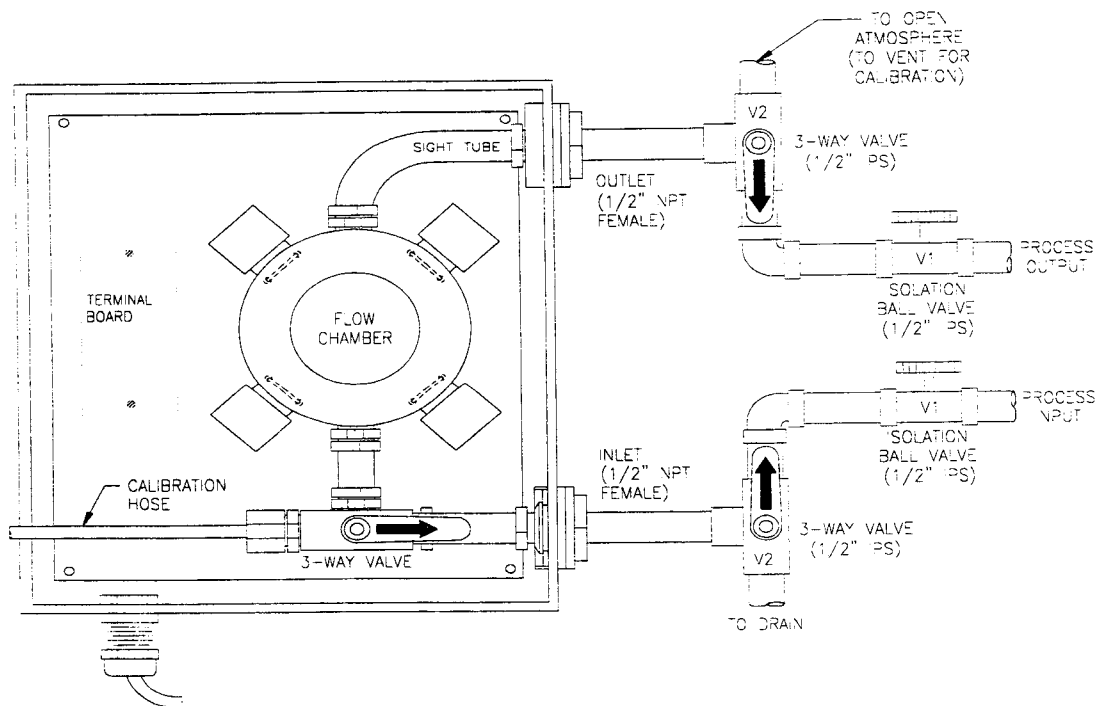

FIGURE 2-1 Recommended Closed-loop Sensor Piping Arrangement

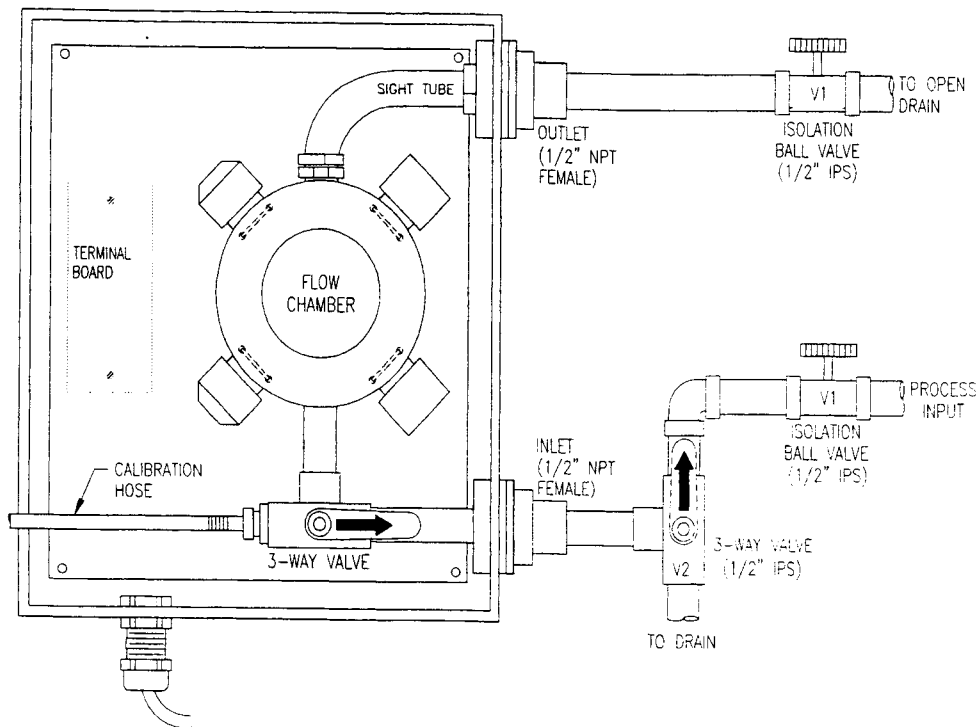

FIGURE 2-2 Recommended Sample Bypass Line Sensor Piping Arrangement

2.2 Sensor Mounting

The Model TRCN-96 Sensor low-range turbidity sensor may be the standard design sensor (Figure 2-3) or the high pressure design sensor which is housed in a different enclosure (Figure 2-4). In either case, vertically orient the sensor (inlet fitting at bottom) and surface mount it where there is little or no mechanical vibration. Use 1/4 inch screws to fasten the enclosure onto a flat surface. (The sensor may be mounted onto a vertical or horizontal 1-1/2 inch or 2 inch diameter pipe using an optional TRCN-96-PM pipe mount kit.



NOTE: Avoid locations where Model TRCN-96 Sensor ambient temperature limits (32-140°F; 0-60°C) may be exceeded.

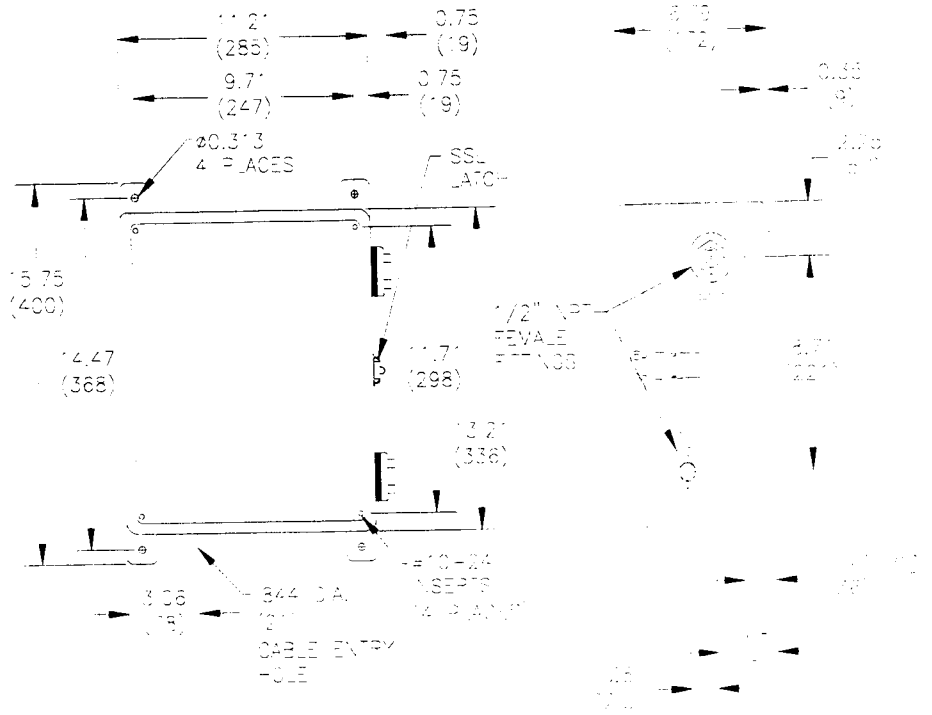

Note: Dimensions shown in inches (mm).

FIGURE 2-3 Standard Design Model TRCN-96 Sensor -- Installation Dimension Details

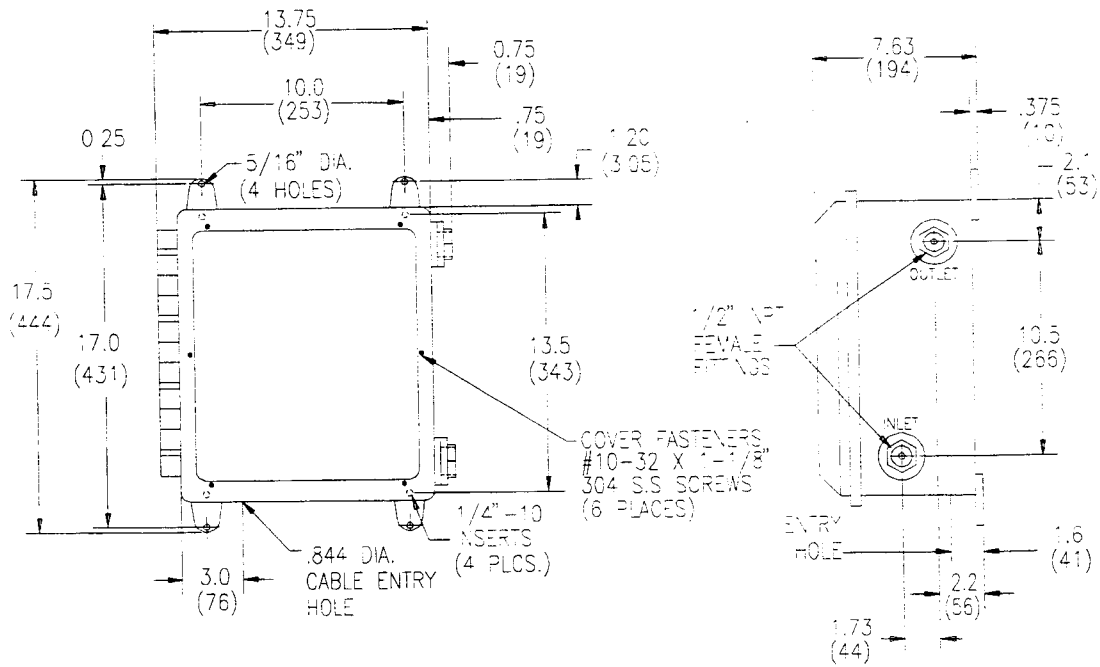

Note: Dimensions shown in inches (mm).

FIGURE 2-4 High Pressure Design Model TRCN-96 Sensor -- Installation Dimension Details

2.3 Sensor Plumbing Connections

Plumb the process into the Model TRCN-96 Sensor inlet fitting. Plumb the sensor outlet fitting back into the process line (Figure 2-1) or to an open drain (Figure 2-2). Bushings may be used to reduce to a smaller pipe size. Barb or tube fittings may be installed. **Recommendation:** Use larger sample tubing for applications in which sediment buildup commonly occurs. The resultant faster flow rate helps flush sediment through the sensor.



NOTE: Use teflon tape to seal the inlet and outlet connections. Do not use pipe dope or other liquid sealants. **Recommendation:** Use ball valves (V1 designations in Figure 2-1 and 2-2) to conveniently isolate the sensor when calibrating or removing the sensor. In a closed-loop piping arrangement (Figure 2-1), 3-way valves (V2 designations) are required to conveniently drain the flow chamber during calibration. A bypass line piping arrangement (Figure 2-2) only requires one 3-way valve.

CAUTION: WHEN USING METAL FITTINGS, DO NOT EXCESSIVELY TIGHTEN THEM ONTO THE SENSOR'S PLASTIC INLET AND OUTLET -- THEY MAY CRACK.



NOTE: When choosing the sampling point for the process pipe plumbing connection, avoid a top-of-pipe or bottom-of-pipe location. Figure 2-5 illustrates the best sampling point location: side-of-pipe with sample line inserted to the process pipe centerline.

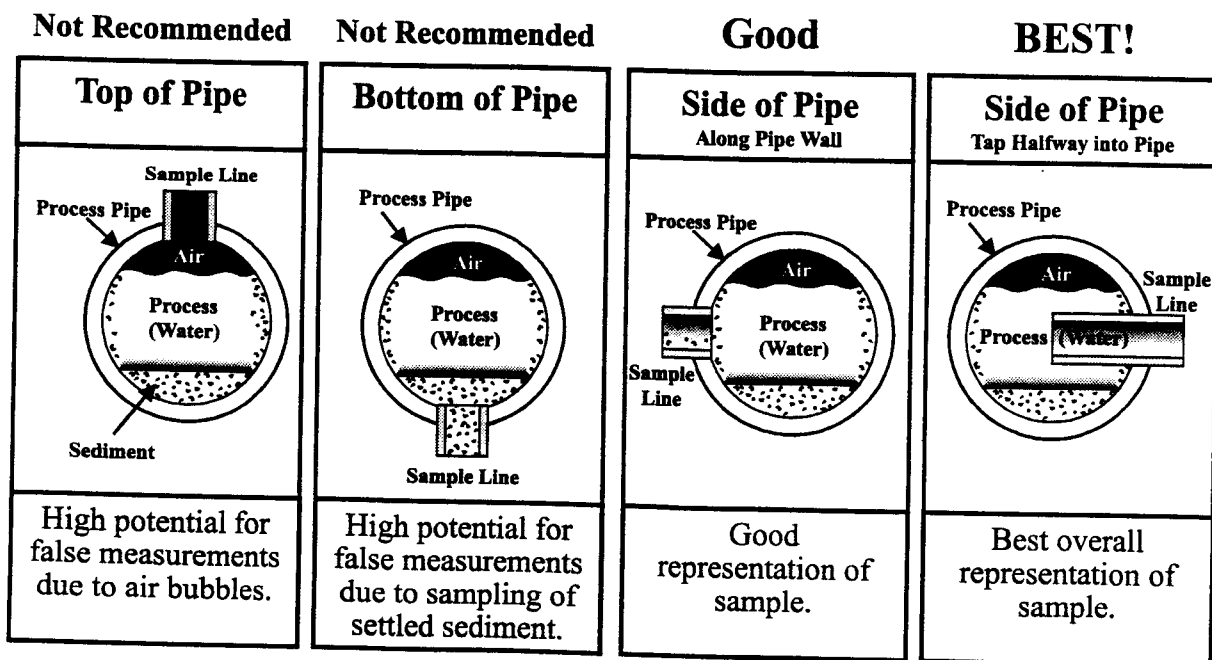

Figure 2-5 Sampling Point Guidelines for Process Pipe Plumbing Connection

2.4 Analyzer Location

1. Locate the analyzer as close as possible to the installed sensor. Do not exceed a maximum distance of 30 feet (9 m) between the sensor and analyzer. (Consult factory if longer distances are required.)
2. Mount the analyzer in a location that is:
 - Clean and dry where there is little or no vibration.
 - Protected from corrosive fluids.
 - Within ambient temperature limits (-4 to +140°F or -20 to +60°C).

CAUTION:

EXPOSING THE ANALYZER TO DIRECT SUNLIGHT MAY INCREASE THE OPERATING TEMPERATURE ABOVE ITS SPECIFIED LIMIT.

2.5 Analyzer Mounting

Figure 2-6 illustrates various ways to mount the analyzer using the supplied bracket and hardware. Determine the mounting method and attach the hardware as shown in the respective illustration. Refer to Figure 2-7 for analyzer installation dimension details.

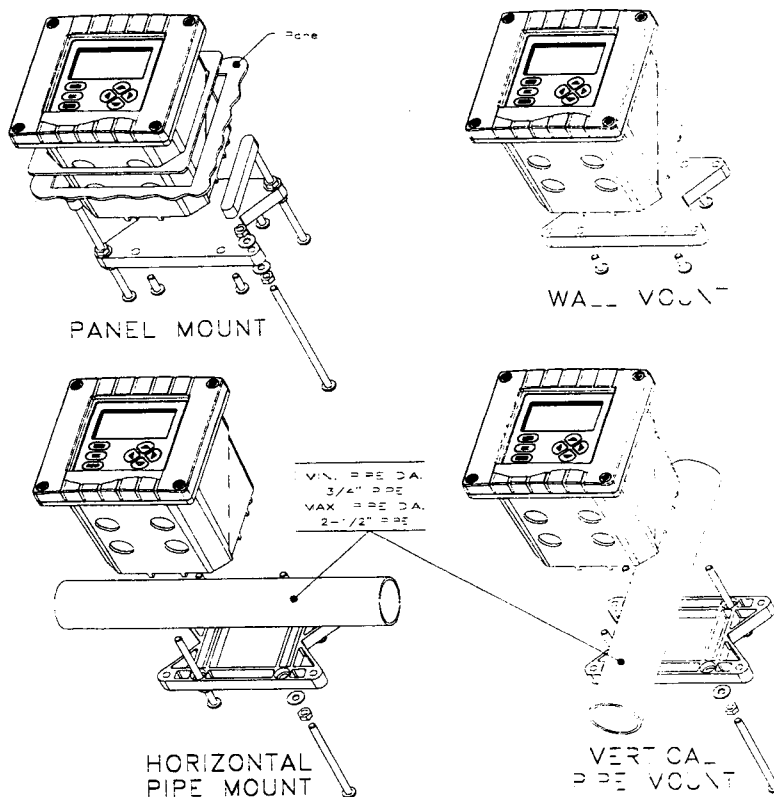

FIGURE 2-6 Analyzer Mounting Arrangements

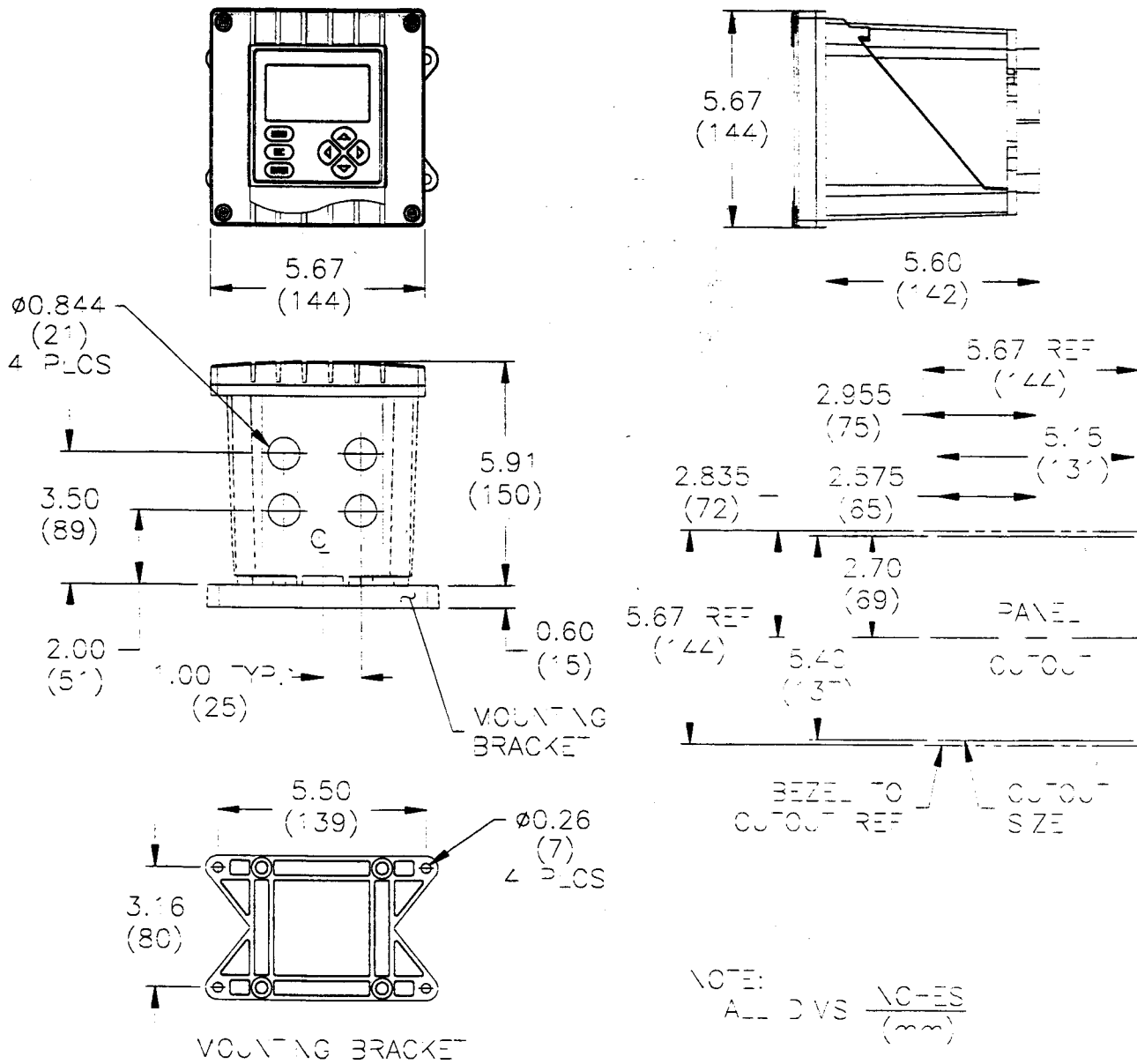

FIGURE 2-7 Analyzer Installation Dimensions Details

2.6 Sensor and Analyzer Conduit Hole Requirements

Recommendation: Run all wiring to the sensor and analyzer in 1/2-inch, grounded metal conduits. If using only shielded cables, appropriate strain reliefs or cable grips are required. Seal unused cable entry holes with appropriate plugs.

NOTE: Use NEMA 4 (≅ CSA type 4; ≅ IP65) rated fittings and plugs to maintain the watertight integrity of the NEMA 4X sensor and analyzer enclosures, and to comply with Div. 2 hazardous area requirements.



SECTION 3

ELECTRICAL CONNECTIONS

To access terminal blocks for electrical connections, open the left-hinged enclosure door by unscrewing the four fasteners. Figure 2-8 or 2-9 shows the terminal block arrangement and terminal designations inside the analyzer.



NOTE: All terminals are suitable for single wires up to 14 AWG (2.5 mm²).



Wiring Tip! To comply with European Community (CE) electromagnetic compatibility requirements, follow these general wiring guidelines:

1. Keep all cable shields as short as possible inside the analyzer, and connect them to the ground terminals provided. Performance may be improved by using cable glands that enable the shield to directly contact the analyzer chassis.
2. Use Steward ferrite 28 B0590-000 or equivalent on the sensor cable -- two turns required.
3. In harsh conducted RF conditions, connect the earth ground of the analyzer to a local, known earth ground source.



NOTE: For ease of wiring, route line power and relay outputs through the back conduit holes, and use the front conduit holes for all other wiring.

3.1 Omega Engineering Model TRCN-96 Sensor Low-range Turbidity Sensor

The Model TRCN-96 Sensor is supplied with LED light source and detector cables connected to its terminal board. Remove its protective cover to check that these cables have not been accidentally disconnected during shipment (refer to wiring diagram on inside of sensor enclosure door).



Wiring Tip! Route the sensor cable in 1/2-inch, grounded metal conduit to protect it from moisture, electrical noise, and mechanical damage.



NOTE: Do not route sensor cable in any conduit containing AC power wiring ("electrical noise" may interfere with sensor signal). Also, always re-calibrate the system when the cable length between sensor and analyzer changes.

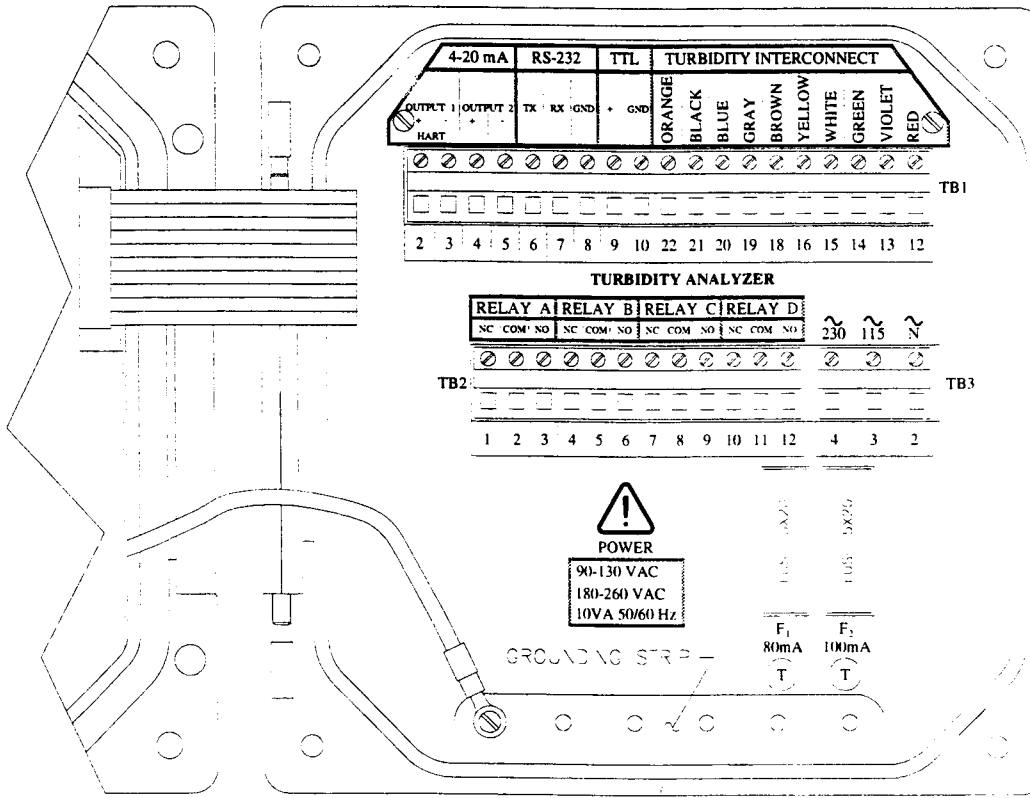

FIGURE 2-8 Terminal Block Designations for Analyzers with "B" Prefix Serial Number

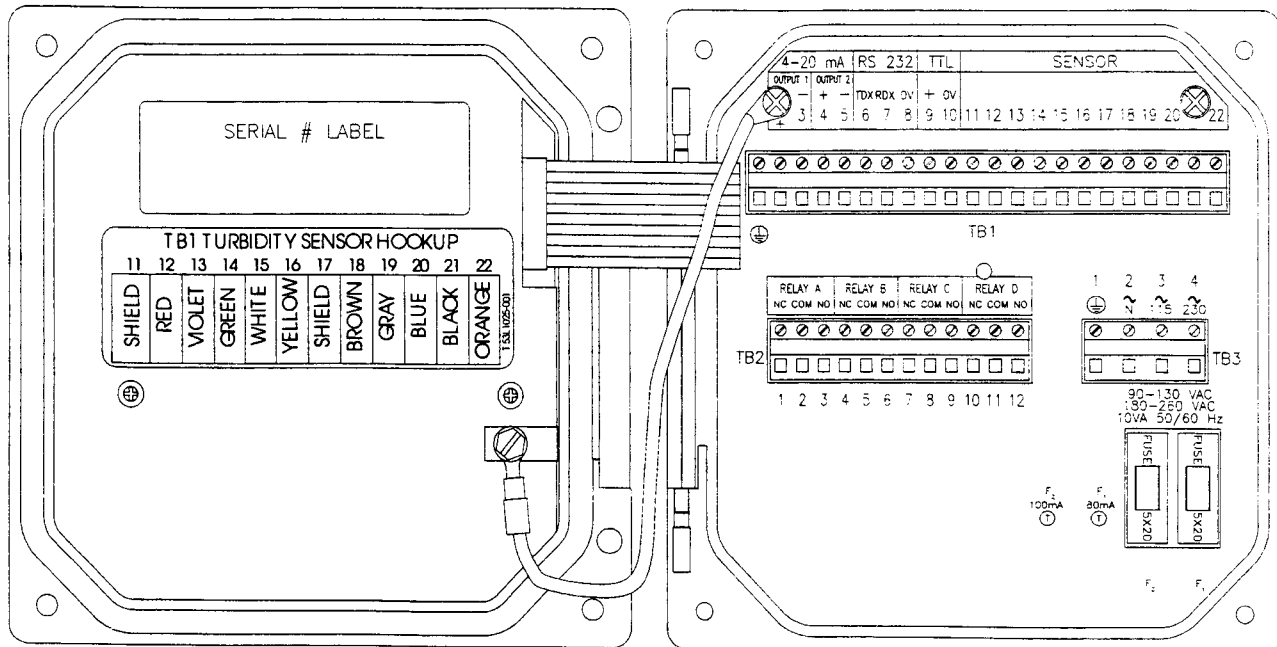

FIGURE 2-9 Terminal Block Designations for Analyzers with No Letter Prefix Serial Number

Refer to Figure 2-10 or 2-11 and connect the sensor (or interconnect) cable wires to appropriate terminals on TB1, matching colors as indicated.

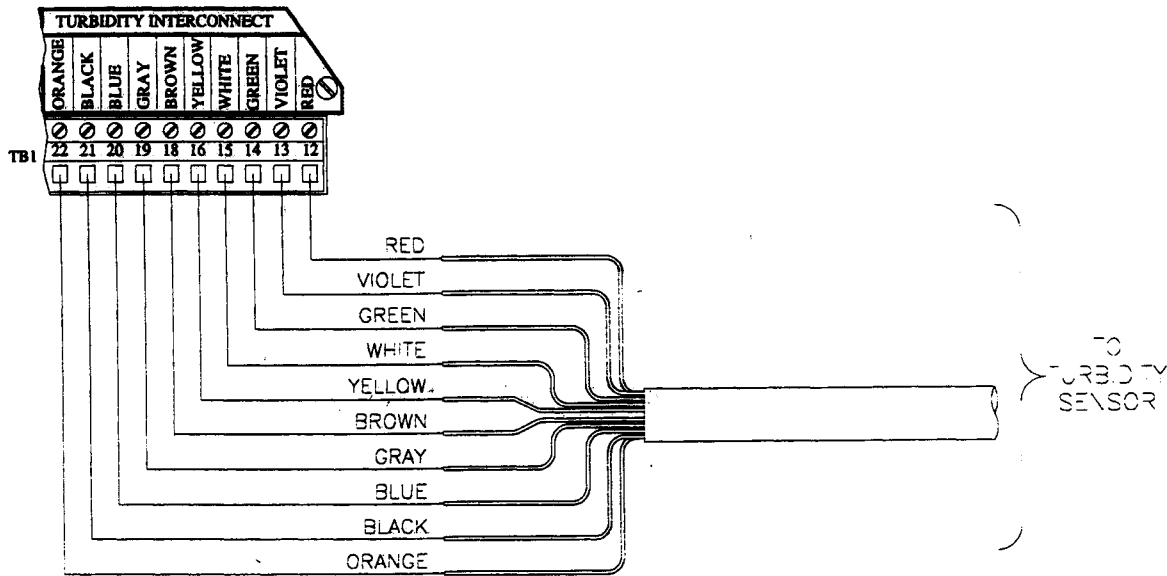

FIGURE 2-10 Connecting Model TRCN-96 Sensor Low-range Turbidity Sensor to Analyzers with "B" Prefix Serial Number

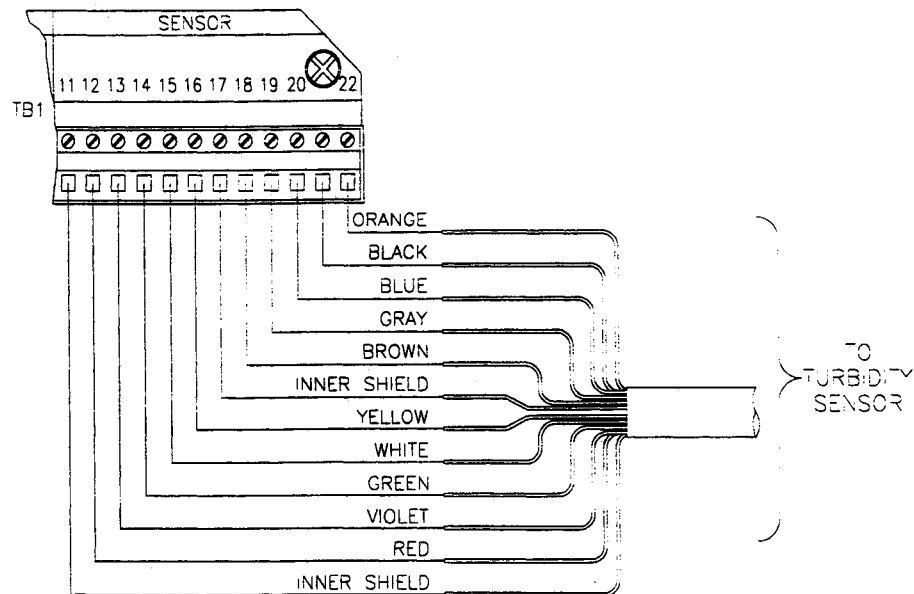

FIGURE 2-11 Connecting Model TRCN-96 Sensor Low-range Turbidity Sensor to Analyzers with No Letter Prefix Serial Number

3.2 Analog Outputs

Two isolated analog outputs (1 and 2) are provided. Each output represents the measured turbidity, and can be set to be 0/4-20 mA. **The outputs are isolated from the inputs and earth ground, but not from each other.** For details on configuring the outputs, refer to Part Three, Section 4.3.



Wiring Tip! Use high quality, shielded instrumentation cable for connecting the analog outputs. To protect the output signal from EMI/RFI, connect cable shields to:

- The grounding strip at bottom of case (5 open holes, Fig. 2-8) for analyzers with "B" prefix serial number.
- The "ground symbol" Terminal 1 on TB1 (Figure 2-9) for analyzers with no letter prefix serial number.

Each 0/4-20 mA output can drive a load of up to 600 ohms.

- **Output 1:** Connect the load to Terminals 2 and 3 on TB1, matching polarity as indicated.
- **Output 2:** Connect the load to Terminals 4 and 5 on TB1, matching polarity as indicated.

3.3 Relay Outputs

The analyzer is equipped with four electromechanical relays. For relay setup details, see Part Three, Section 4.4.

CAUTION:

DO NOT EXCEED THE CONTACT RATING FOR EACH RELAY (5A 115/230 VAC). WHEN SWITCHING LARGER CURRENTS, USE AN AUXILIARY RELAY SWITCHED BY THE ANALYZER RELAY TO EXTEND ANALYZER RELAY LIFE. WHEN USING RELAY OUTPUTS, MAKE SURE THAT LINE POWER WIRING CAN ADEQUATELY CONDUCT THE CURRENT DRAW OF THE SWITCHED LOAD(S).

Four sets of SPDT relay outputs (Relays A, B, C, and D) are provided at Terminals 1 through 12 on TB2. **The relay outputs are not powered.** The line power used to power the analyzer may also be used to power the control or alarm devices with these relay contacts. Refer to Figure 2-12 for a general wiring arrangement. Always check control wiring to insure that line power will not be shorted by the relay switching action, and that wiring conforms to local codes.

WARNING:

MAKE SURE THAT LINE POWER IS NOT PRESENT WHILE CONNECTING WIRES TO TB2 RELAY TERMINALS.

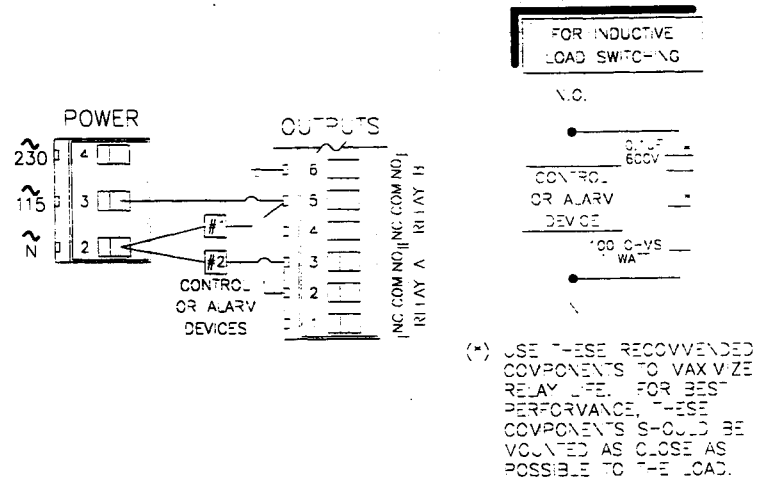

FIGURE 2-12 Connecting Control/Alarm Device(s) to Electromechanical Relay(s)

3.4 Closed Contact TTL Input

The closed contact TTL input feature of the analyzer enables you to conveniently:

- Hold the analog outputs at their present values.
- Hold all CONTROL or ALARM relays at their present on/off states.

To activate holding the analog outputs and relays, remotely or locally jumper Terminals 9 and 10 on TB1.

3.5 Line Power

Refer to appropriate figures and connect line power to TB3 terminals using the standard three-wire connection arrangement. **Use wiring practices which conform to local codes** (example: National Electric Code Handbook in the U.S.A.).

WARNING:

REMOVE LINE POWER WHILE CONNECTING LINE POWER WIRES TO THE TB3 TERMINALS. ALSO, USE ONLY THE STANDARD THREE-WIRE CONNECTION ARRANGEMENT FOR SINGLE-PHASE LINE POWER TO PREVENT AN UNSAFE CONDITION, AND TO ENSURE PROPER ANALYZER OPERATION.



NOTE: *In all cases, connect the line power cable ground wire (usually green) to:*

- *The grounding strip at bottom of case (5 open holes -- Figures 2-13, 2-15, or 2-17) for analyzers with "B" prefix serial number.*
- *The "ground symbol" Terminal 1 on TB3 (Figures 2-14, 2-16, or 2-18) for analyzers with no letter prefix serial number.*

The "115" and "230" voltage circuits are protected with internal, board-mounted slow-blow fuses.



NOTE: *For 230 volt split phase line power, be sure to conform to local codes with regard to fusing the 115 volt line connected to the "N" terminal.*

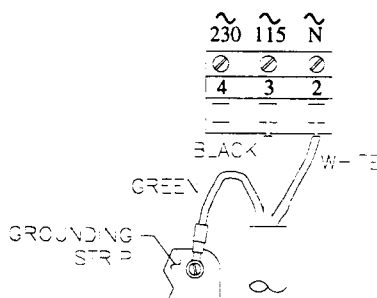

FIGURE 2-13
Connecting 115 V Single Phase
to Analyzers with "B" Prefix Serial Number

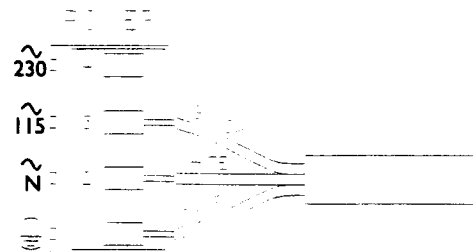

FIGURE 2-14
Connecting 115 V Single Phase
to Analyzers with No Letter Prefix Serial Number

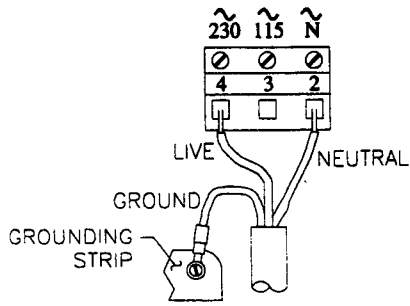

FIGURE 2-15
Connecting 230 V Single Phase
to Analyzers with "B" Prefix Serial Number

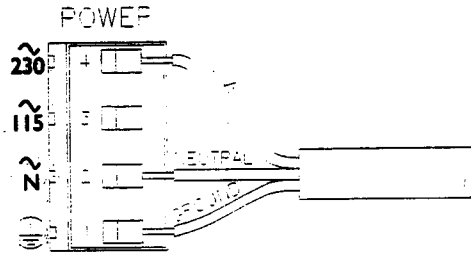

FIGURE 2-16
Connecting 230 V Single Phase
to Analyzers with No Letter Prefix Serial Number

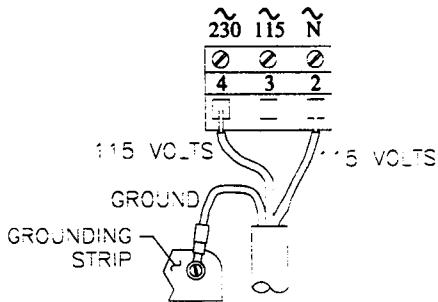

FIGURE 2-17
Connecting 230 V Split Phase
to Analyzers with "B" Prefix Serial Number



FIGURE 2-18
Connecting 230 V Split Phase
to Analyzers with No Letter Prefix Serial Number

PART THREE - OPERATION

SECTION 1

USER INTERFACE

The user interface consists of an LCD display and a keypad with **MENU**, **ENTER**, **ESC**, \leftarrow , \rightarrow , \uparrow , and \downarrow keys.

1.1 Display

By using the keypad, you can display three basic types of screens:

- **MEASURE screen** to show measured values. The measured turbidity is always shown on the display's main middle line. Pressing the \downarrow and \uparrow keys changes the display's bottom auxiliary line (in reverse video) to show the Analog Output 1 or 2 value in mA.

An example of a typical MEASURE screen is:



0.284_{NTU}

On the MEASURE screen's top line, Relay A, B, C, and D annunciators will appear when their relay operational state changes. When a relay overfeed timer is used and it has "timed out," the respective relay annunciator continuously blinks until the overfeed condition is resolved.

- **MENU screens** to move within the three main branches of the analyzer menu tree, enabling access to edit/selection screens. (EXIT screens indicate the end of a menu branch and enable you, by pressing the **ENTER** key, to move up one level in the menu tree. This is functionally the same as pressing the **ESC** key.)
- **Edit/Selection screens** to enter values/choices to calibrate, configure, and test the analyzer.

1.2 Keypad

The keypad enables you to move throughout the analyzer menu tree. The keys and their related functions are:

1. **MENU key:** Pressing this key always displays the top of the menu tree ("MAIN MENU" selection screen). To display the top-level menu screen for a desired main branch (CALIBRATE, CONFIGURE, or TEST/MAINT), use \downarrow and \uparrow keys to select the corresponding line, and

press **ENTER** key. The **MENU** key can also be used to “abort” the procedure to change values or selections.

2. **ENTER** key: Pressing this key displays an available menu or edit/selection screen, or enters (saves) values or selections.
3. **ESC** key: Pressing this key always takes the display up one level in the menu tree. (Example: With the “MAIN MENU” branch selection screen displayed, pressing the **ESC** key once takes the display up one level to the MEASURE screen.) This key can also “abort” the procedure to change a value or selection.
4. **⇐** and **⇒** keys: Depending on the type of displayed screen, these keys do the following:
 - MEASURE Screen: These keys are non-functional.
 - Menu Screens: These keys are non-functional.
 - Edit/Selection Screens: “Coarse” adjusts the displayed numerical value.
5. **↑** and **↓** keys: Depending on the type of displayed screen, these keys do the following:
 - MEASURE Screen: Changes the bottom auxiliary display line, shown in reverse video, between Output 1 mA value and Output 2 mA value.
 - Menu Screens: Moves reverse video cursor up or down respectively to select a displayed line item.
 - Edit/Selection Screens: “Fine” adjusts the displayed numerical value (holding key down changes value faster), or moves up or down between choices.

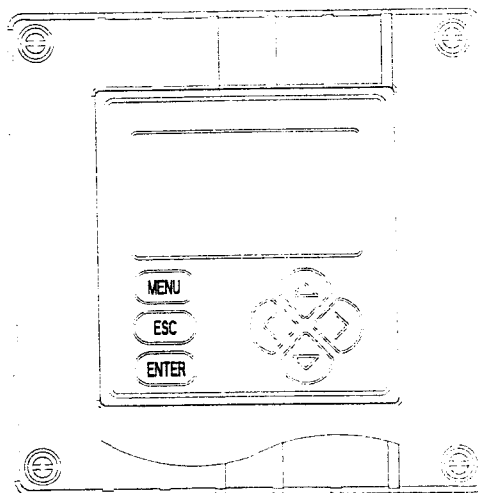

FIGURE 3-1 Analyzer Keypad

1.3 MEASURE Screen (normal display mode)

The MEASURE screen is normally displayed. Pressing the **MENU key** temporarily replaces this screen with various screens to calibrate, configure, or test the analyzer. If the keypad is not used within 30 minutes, except during calibration and while using specific analyzer test/maintenance functions, the display automatically returns to the MEASURE screen. To display the MEASURE screen at any time, press the **MENU key** once and then the **ESC key** once.

When viewing the MEASURE screen, you can press the ↓ or ↑ keys to select between other measurements shown on the bottom auxiliary display line. These MEASURE screen examples illustrate this feature:

BASIN 1 TURBIDITY: ABCD

0.284 NTU

OUTPUT 2: 14.86mA

BASIN 2 TURBIDITY: ABCD

0.295 NTU

OUTPUT 2: 14.86mA



NOTE: When the analyzer returns to its normal MEASURE screen mode, the appearing MEASURE screen is always the version last selected. Note that these MEASURE screen examples show "BASIN 1" notations on their top lines, illustrating the analyzer notation feature. To create your own notation, refer to Part Three, Section 4.2, under the subheading "ENTER NOTE (top line of MEASURE screen)."

When a measured value is beyond the analyzer measuring range, a series of "+" or "-" screen symbols appear, respectively indicating that the value is above or below range.

SECTION 2

MENU STRUCTURE

The analyzer menu tree is divided into three main branches: CALIBRATE, CONFIGURE, and TEST/MAINT. Each main branch is structured similarly in layers with top-level menu screens, related lower-level submenu screens and, in many cases, sub-submenu screens.

Each layer contains an EXIT line or screen to return the display up one level to the previous layer of screens. For convenience, the layers within each main branch are organized with the most frequently used functions at their beginning, rather than the functions used for initial startup.

2.1 Displaying Main Branch Selection Screen

Press the **MENU** key to always display this main branch selection screen:

```

MAIN MENU
▶CALIBRATE
▶CONFIGURE
▶TEST/MAINT
◀EXIT
  
```

2.2 Displaying Top-level Menu Screens

1. After displaying the main branch selection screen, use the **↓** and **↑** keys to select the line corresponding to the desired branch (shown in reverse video).
2. Press the **ENTER** key to display the top-level menu screen for that branch.

The top-level menu screens for each main branch are:

```

CALIBRATE
▶CALIBRATE
▶CAL OUTPUTS
◀EXIT
  
```

```

CONFIGURE
▶SET OUTPUT 1
▶SET OUTPUT 2
▶SET RELAY A
▶SET RELAY B
▶SET RELAY C
▶SET RELAY D
▶SET PASSCODE
▶LANGUAGE
▶SENSOR
◀EXIT
  
```

```

TEST/MAINT
▶STATUS
▶CHECK CAL/HOLD
▶OVERFEED RESET
▶OUTPUT 1
▶OUTPUT 2
▶RELAY A
▶RELAY B
▶RELAY C
▶RELAY D
▶SENSOR TYPE
▶EPROM VERSION
▶SIM SENSOR
▶RESET DEFAULTS
◀EXIT
  
```



Menu Structure Tip! The ▶ symbol pointing at each listed item indicates there is a related lower-level submenu screen, sub-submenu screen or edit/selection screen.

Some menu lists are too long to completely fit on the screen. A ↓ symbol at the bottom right of the list indicates

that you can display hidden items by pressing the \Downarrow key. As you display these items a \uparrow symbol appears, indicating that items now hidden above and below the list can be displayed by respectively pressing the \uparrow or \Downarrow key. When a \uparrow symbol appears, it indicates you have reached the end of the menu list. You can move back up the list using the \uparrow key.



NOTE: The \triangleright symbol pointing at a listed menu item indicates that this item is not relevant to, nor required for, the previously entered setup choices and, therefore, is not available.

2.3 Displaying Submenu Screens

1. After displaying the top-level menu screen, use the \Downarrow and \uparrow keys to select the line corresponding to the desired lower-level submenu screen.
2. Press the **ENTER** key to display the submenu screen.

When a submenu or sub-submenu screen contains a first line ending with a "?," it is an edit/selection screen. Pressing the \Downarrow or \uparrow key changes the value/choice enclosed by parenthesis (second line on screen).

Example: With this submenu edit screen displayed:

```
SET FUNCTION?
(ALARM      )
```

pressing the \Downarrow key displays this related choice:

```
SET FUNCTION?
(CONTROL    )
```

2.4 Adjusting Edit/Selection Screen Values

Edit/selection screens always contain a second line enclosed by parenthesis -- see examples shown above and below. The enclosed value/choice can be edited/changed by using the \uparrow and \Downarrow keys. Pressing the **ENTER** key saves the change.

```
LANGUAGE?
(ENGLISH  )
```

```
SET 4mA VALUE?
(0.236 NTU )
```

Use the \Leftarrow and \Rightarrow keys to "coarse" adjust numerical values. The \uparrow and \Downarrow keys "fine" adjust numerical values up or

2.5 Entering (Storing) Edit/Selection Screen Values/Choices



down respectively. The longer the key is pressed, the faster the number changes.

After the desired value/choice is displayed, press the **ENTER** key to enter (store) it into the non-volatile analyzer memory. The previous screen will then re-appear.

NOTE: You can always press the **ESC** key to abort saving a new setting. The original setting will be retained.

SECTION 3

ADJUSTING DISPLAY CONTRAST

Ambient lighting conditions may make it necessary to adjust the analyzer display contrast to improve visibility. With the MEASURE screen displayed, press and hold the **ENTER** key and simultaneously press the **↑** or **↓** key until attaining the desired contrast.

SECTION 4

CONFIGURING THE ANALYZER



NOTE: When the passcode feature is enabled (Section 4.5), you must successfully enter the passcode before attempting to enter a configuration setting.

4.1 Selecting LANGUAGE to Operate Analyzer

The analyzer can display screens in various languages including English, French (Français), German (Deutsche), Spanish (Español), and others. The analyzer is factory-set for English. To change languages:

```

MAIN MENU
▶CALIBRATE
▶CONFIGURE
▶TEST/MAINT
◀EXIT
  
```

1. Press **MENU** key to display . Use **↓** key to select the "CONFIGURE" line.

```

CONFIGURE
▶SET OUTPUT 1
▶SET OUTPUT 2
▶SET RELAY A
▶SET RELAY B
▶SET RELAY C
▶SET RELAY D
▶SET PASSCODE
▶LANGUAGE
▶SENSOR
▶EXIT
  
```

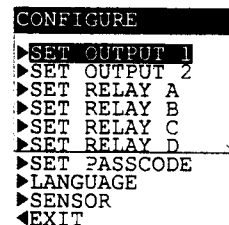
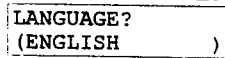
2. Press **ENTER** key to display . Use **↓** key to select the "LANGUAGE" line.
3. Press **ENTER** key to display a screen like . Use **↓** and **↑** keys to view the language choices.
4. With the desired language displayed, press **ENTER** key to enter this selection.



NOTE: After a language is selected and entered, all screens will be displayed in that language.

4.2 Configuring Sensor Characteristics

SELECT UNITS

You may want to configure the analyzer to define related sensor characteristics such as units of measure, input signal filtering, pulse suppression, and a MEASURE screen top line notation to specifically tailor the instrument to your application.

The TRCN-96 SYSTEM™ Low-range Turbidity Meter System is factory set to display turbidity in NTUs. However, you may want to select different measurement units:

```

CONFIGURE
▶SET OUTPUT 1
▶SET OUTPUT 2
▶SET RELAY A
▶SET RELAY B
▶SET RELAY C
▶SET RELAY D
▶SET PASSCODE
▶LANGUAGE
▶SENSOR
◀EXIT

```

1. With the **CONFIGURE** screen displayed, use **↓** key to select the "SENSOR" line.

```

SENSOR
▶SELECT UNITS
▶SET FILTER
▶PULSE SUPPRESS
▶ENTER NOTE
◀EXIT

```

2. Press **ENTER** key to display
3. With the "SELECT UNITS" line selected, press **ENTER** key to display a screen like

```
SELECT UNITS?
(NTU )
```

. Use **↓** and **↑** keys to view all choices which are all equivalent:
 - NTU (Nephelometric Turbidity Units)
 - FTU (Formazin Turbidity Units)
 - FNU (Formazin Nephelometric Units)
 - TEF (Truebungseinheit Formazin -- a German unit)
4. With the desired choice displayed value, press **ENTER** key to enter this selection.

SET FILTER Time

A time constant (in seconds) can be set to filter or "smooth out" the sensor signal. A minimum value of "0 seconds" has no smoothing effect. A maximum value of "60 seconds" provides maximum smoothing. Deciding what sensor signal filter time to use is a compromise. The higher the filter time, the longer the sensor signal response time will be to a change in the actual turbidity value.

```

SENSOR
▶SELECT UNITS
▶SET FILTER
▶PULSE SUPPRESS
▶ENTER NOTE
◀EXIT

```

1. With the **SENSOR** screen displayed, use **↓** key to select the "SET FILTER" line.
2. Press **ENTER** key to display a screen like

```
SET FILTER?
(30 SECONDS )
```

.
3. Adjust the displayed value to the desired filter time, and press **ENTER** key to enter the value. (Use **⇒** and **⇐** keys for coarse adjust; **↑** and **↓** keys for fine adjust.)

Select
PULSE SUPPRESS
(on/off)

Sometimes an external interference may occasionally cause the measurement system to provide unstable readings. Common causes include entrained gas bubbles in the sample, and electromagnetic interference (EMI or “electrical noise” pulses). The analyzer has a pulse suppression feature to counteract this condition and stabilize readings. **Example:** Suppose the analyzer reading is steadily showing 0.284 NTU, then suddenly jumps to 0.396 NTU for a few seconds, and returns to 0.284 NTU. By turning on this feature, the analyzer will perceive this as a temporary upset, “suppressing” most of this pulse change and providing a smoother measurement reading.

```

SENSOR
└─SELECT UNITS
└─SET FILTER
└─PULSE SUPPRESS
└─ENTER NOTE
└─EXIT
  
```

1. With the _____ screen displayed, use **↓ key** to select the “PULSE SUPPRESS” line.
2. Press **ENTER key** to display a screen like

```
PULSE SUPPRESS?  
(OFF )
```

. Use **↓ and ↑ keys** to view both choices (OFF or ON).
3. With the desired choice displayed, press **ENTER key** to enter this selection.

ENTER NOTE (top line
of MEASURE screen)

The MEASURE screen top line is factory set to read “TRCN-96 SYSTEM.” This notation can be changed, for example, to “BASIN 1” to tailor the MEASURE screen to the application. The notation is limited to eight characters which can be a combination of capital letters A through Z, numbers 0 through 9, and spaces.

```

SENSOR
└─SELECT UNITS
└─SET FILTER
└─PULSE SUPPRESS
└─ENTER NOTE
└─EXIT
  
```

1. With the _____ screen displayed, use **↓ key** to select the “ENTER NOTE” line.
2. Press **ENTER key** to display

```
ENTER NOTE?  
([A]CCU4 )
```

. Create the desired notation within second line’s parenthesis:
 - A. Starting with extreme left character position, use **↑ and ↓ keys** to select the desired first character.
 - B. Press **⇒ key once** to select the next character, and use **↑ and ↓ keys** to select desired character.
 - C. Repeat procedure until desired notation is displayed.
3. Press **ENTER key** to enter the displayed notation.

4.3 Configuring Analog Outputs (1 and 2)

Analyzer provides two isolated analog outputs (1 and 2), each representing the measured turbidity. During calibration, both analog outputs can be held at their present values, transferred to a preset value, or remain active. During normal measurement operation, both outputs can be:

- Held for up to 30 minutes by using the “CHECK CAL/HOLD” function in the TEST/MAINT menu.
- Held indefinitely by locally or remotely connecting both TTL input terminals on TB1.

If a TEST/MAINT hold is applied in addition to a TTL hold, both “holds” must be removed before the outputs return to active status. If the outputs are set to “XFER” or “ACTIVE” during a calibration, they remain in that state until after calibration regardless of the TTL input status.

These instructions configure Output 1. Configure Output 2 in the same way using its respective menu screens.

SET 0/4 and
20 mA VALUES

You can set the turbidity values to define the endpoints at which the minimum and maximum output values are desired.

```

CONFIGURE
▶SET OUTPUT 1
▶SET OUTPUT 2
▶SET RELAY A
▶SET RELAY B
▶SET RELAY C
▶SET RELAY D
▶SET PASSCODE
▶LANGUAGE
▶SENSOR
◀EXIT
  
```

1. With the top-level menu screen displayed and the “SET OUTPUT 1” line selected, press

```

SET OUTPUT 1
▶SET 0mA VALUE
▶SET 20mA VALUE
▶SET TRANSFER
▶SET FILTER
▶SCALE 0mA/4mA
◀EXIT
  
```

ENTER key to display

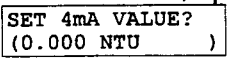
- With the "SET 4 mA VALUE" line selected, press **ENTER** key to display a screen like .
- Set the displayed value at which 0/4 mA is desired, and press **ENTER** key to enter the value. (Use \Rightarrow and \Leftarrow keys for coarse adjust; \uparrow and \downarrow keys for fine adjust.)

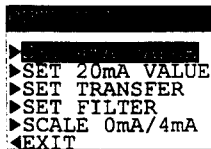

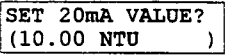
- After the  screen re-appears, use \downarrow key to select the "SET 20 mA VALUE" line.

- Press **ENTER** key to display a screen like .

- Set the displayed value at which 20 mA is desired, and press **ENTER** key to enter the value.





NOTE: If the same values are set for 0/4 mA and 20 mA, the output automatically goes to, and remains at, 20 mA.

SET TRANSFER Value (mA)

Normally, each analog output is active, responding to the measured turbidity value. During calibration, however, you can transfer (XFER) each output to a preset value to operate a control element by an amount corresponding to that value.

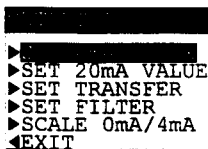
If you desire to set a milliamp transfer value for an analog output to suit your application, follow these steps:



- With the  screen displayed, use \downarrow key to select the "SET TRANSFER" line.
- Press **ENTER** key to display a screen like .
- Set the displayed value to the desired transfer value, and press **ENTER** key to enter it. (Use \Rightarrow and \Leftarrow keys for coarse adjust; \uparrow and \downarrow keys for fine adjust.)

SET FILTER Time

A time constant (in seconds) can be set to filter or “smooth out” the output signal. A minimum value of “0 seconds” has no smoothing effect. A maximum value of “60 seconds” provides maximum smoothing. Deciding what output filter time to use is a compromise. The higher the filter time, the longer the output signal response time will be to a change in the measured turbidity.



NOTE: The output filter time setting combines with the sensor signal filter time setting, providing an additive delay in output response to the actual reading.

```

SET FILTER
▶SET 20mA VALUE
▶SET TRANSFER
▶SET FILTER
▶SCALE 0mA/4mA
◀EXIT
  
```

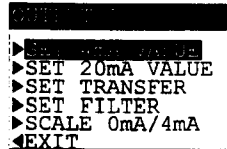
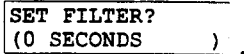
1. With the  screen displayed, use **↓** key to select the “SET FILTER” line.
2. Press **ENTER** key to display a screen like .
3. Adjust the displayed value to the desired filter time, and press **ENTER** key to enter it. (Use **⇒** and **⇐** keys for coarse adjust; **↑** and **↓** keys for fine adjust.)

Select SCALE 0 mA/
4 mA (low endpoint)

Select each output to be 0-20 mA or 4-20 mA.

```

SCALE 0mA/4mA
▶SET 20mA VALUE
▶SET TRANSFER
▶SET FILTER
▶SCALE 0mA/4mA
◀EXIT
  
```

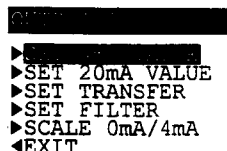
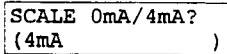
1. With the  screen displayed, use **↓** key to select the “SCALE 0mA/4mA” line.
2. Press **ENTER** key to display . Use **↓** and **↑** keys to view both choices (0 mA or 4 mA).
3. With the desired choice displayed, press **ENTER** key to enter this selection.

4.4 Configuring Relays (A, B, C, and D)

The analyzer is equipped with four electromechanical relays (A, B, C, and D). Each relay can be set to function as a CONTROL, ALARM, or STATUS relay. For details on each relay function, see subsection "SET FUNCTION Mode."

During calibration, CONTROL and ALARM (not STATUS) relays can be held at their present on/off states, transferred to preset on/off states, or remain active. During normal measurement operation, CONTROL and ALARM relays can be:

- Held at their present on/off states for up to 30 minutes by using the "CHECK CAL/HOLD" function in the TEST/MAINT menu.
- Held at their present on/off states indefinitely by locally or remotely connecting both TTL input terminals on TB1.

If a TEST/MAINT hold is applied in addition to a TTL hold, both "holds" must be removed before CONTROL and ALARM relays return to active status. If the relays are set to "XFER" or "ACTIVE" during a calibration, they remain in that state until after calibration regardless of the TTL input status.

These instructions configure Relay A. Configure other relays in the same way using their respective menu screens.

SET FUNCTION Mode
(alarm, control, or status)

Each relay can be selected to function as a:

- **ALARM** relay (with separate high and low alarm points and deadbands) that operates in response to the measured turbidity.
- **CONTROL** relay (with phasing, setpoint, deadband, and overfeed timer) that operates in response to the measured turbidity.
- **STATUS** relay that operates only in response to selected system diagnostic conditions. It can be configured for:

FAIL mode -- sets STATUS relay to activate when there is a FAIL condition (analyzer, light source or detector) or a sensor CHAMBER UNKNOWN condition.

WARN mode -- sets STATUS relay to activate only when there is a sensor flow CHAMBER DIRTY condition.

ALL mode -- sets STATUS relay to activate when there is any abnormal system condition (any FAIL condition, or sensor CHAMBER DIRTY or UNKNOWN condition).

A "WARNING CHECK STATUS" message automatically flashes on the MEASURE screen whenever the analyzer detects any of these system diagnostic conditions:

- ANALYZER FAIL
- CHAMBER DIRTY
- CHAMBER UNKNOWN
- SOURCE 1 FAIL
- SOURCE 2 FAIL
- DETECT 1 FAIL
- DETECT 2 FAIL

To determine the condition causing the warning message, display the "STATUS" screens in the TEST/MAINT menu branch. For more details, see Part Three, Section 6.1.

Relay D is factory-set to function as a STATUS relay but can be configured as a CONTROL or ALARM relay.

1. With the  screen displayed, press **ESC**

key once to display

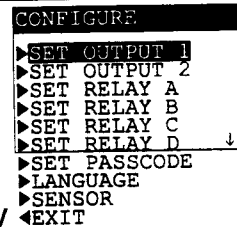

2. Use **↓** key to select the "SET RELAY A" line, and press

ENTER key to display

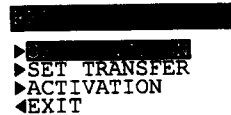

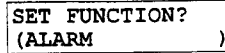
3. With the "SET FUNCTION" line selected, press **ENTER** key to display a screen like . Use **↓** and **↑** keys to view the choices (ALARM, CONTROL or STATUS).

4. With the desired choice displayed, press **ENTER** key to enter this selection.

SET TRANSFER Mode (relay on or off)

Normally, each CONTROL or ALARM relay is ACTIVE, responding to the measured turbidity. During calibration, however, you can transfer (XFER) each relay to a preset on/off state.

If you desire to set a relay on/off transfer state for a CONTROL or ALARM relay to suit your application, follow these steps:

```

RELAY A
▶ DE-ENERGIZED
▶ SET TRANSFER
▶ ACTIVATION
◀ EXIT
  
```

1. With the _____ screen displayed, use ↓ **key** to select the "SET TRANSFER" line.
2. Press **ENTER key** to display a screen like

```

SET TRANSFER?
(DE-ENERGIZED )
  
```

. Use ↓ **and** ↑ **keys** to view both choices (DE-ENERGIZED or ENERGIZED).
3. With the desired choice displayed, press **ENTER key** to enter this selection.

SET ACTIVATION (configuration values)

The group of configuration settings available to a relay is dependent on its selected function mode. Table A describes relay configuration settings, categorized by function mode:

Table A -- RELAY CONFIGURATION SETTINGS	
Setting	Description
For ALARM Relay	
Low Alarm	Sets the value at which the relay will turn on in response to <u>decreasing</u> measured value.
High Alarm	Sets the value at which the relay will turn on in response to <u>increasing</u> measured value.
Low Deadband	Sets the range in which the relay remains on after the measured value <u>increases above</u> the low alarm value.
High Deadband	Sets the range in which the relay remains on after the measured value <u>decreases below</u> the high alarm value.
Off Delay	Sets a time (0-300 seconds) to delay the relay from normally turning <u>off</u> .
On Delay	Sets a time (0-300 seconds) to delay the relay from normally turning <u>on</u> .
For CONTROL Relay	
Phase	A "high" phase assigns the relay setpoint to respond to increasing measured value; conversely, a "low" phase assigns the relay setpoint to respond to decreasing measured value.
Setpoint	Sets the value at which the relay will turn on.

Table A -- RELAY CONFIGURATION SETTINGS -- continued	
Setting	Description
For CONTROL Relay (continued)	
Deadband	Sets the range in which the relay remains on after the measured value decreases below the setpoint value (high phase relay) or increases above the setpoint value (low phase relay).
Overfeed Timer	Sets the time (0-999.9 min.) to limit how long the relay can remain "on." For more details on overfeed timer operation, see Part Three, Section 7.
Off Delay	Sets a time (0-300 seconds) to delay the relay from normally turning <u>off</u> .
On Delay	Sets a time (0-300 seconds) to delay the relay from normally turning <u>on</u> .
For STATUS Relay	
Fail	Sets the relay to turn on only when there is a FAIL condition (analyzer, light source or detector) or a sensor CHAMBER UNKNOWN condition.
Warn	Sets the relay to turn on only when there is a sensor flow CHAMBER DIRTY condition.
All	Sets the relay to turn on when there is <u>any</u> abnormal system condition (any FAIL condition, or sensor flow CHAMBER DIRTY or UNKNOWN condition).



NOTE: Also, it is possible to enter values that always keep a relay active or inactive. To avoid this, be sure that "low" values are lower than "high" values.

The "off delay" and "on delay" settings, available to CONTROL or ALARM relays, may be beneficial in eliminating process "overshoot" when there are long process pipe runs or delays in mixing.

Suppose Relay A is an ALARM. To set configuration values:

```

██████████
▶██████████
▶SET TRANSFER
▶ACTIVATION
◀EXIT
  
```

1. With the _____ screen displayed, use ↓ key to select the "ACTIVATION" line.

```

ACTIVATION
▶██████████
▶HIGH ALARM
▶LOW DEADBAND
▶HIGH DEADBAND
▶OFF DELAY
▶ON DELAY
◀EXIT
  
```

2. Press **ENTER** key to display _____.
3. Use ↓ key to select the appropriate relay setting line, and press **ENTER** key to display its corresponding edit/selection screen.

4. Use the same basic keypad operations described in previous setup procedures to enter the desired value for the displayed relay activation setting.
5. Repeat this procedure for each relay activation setting.

4.5 SET PASSCODE (feature enabled/ disabled)

The analyzer has a passcode feature to restrict access to configuration and calibration settings to only authorized personnel.

- **DISABLED:** With passcode disabled, all configuration settings can be displayed and changed, and the analyzer can be calibrated.
- **ENABLED:** With passcode enabled, all configuration settings can be displayed -- but they cannot be changed, and the analyzer cannot be calibrated. When you attempt to change a setting by pressing the **ENTER key**, a displayed notification requests passcode entry. A valid passcode entry saves the changed setting and returns the display to the "MAIN MENU" branch selection screen. An incorrect passcode entry causes the display to momentarily show an error notification and return to the "MAIN MENU" branch selection screen. There is no limit on attempts to enter a valid passcode.

The passcode is factory-set to "3456." It cannot be changed.

To enable or disable the passcode feature:

```

CONFIGURE
▶SET OUTPUT 1
▶SET OUTPUT 2
▶SET RELAY A
▶SET RELAY B
▶SET RELAY C
▶SET RELAY D
▶SET PASSCODE
▶LANGUAGE
▶SENSOR
◀EXIT
  
```

1. With the top-level menu screen displayed, use **↓ key** to select the "SET PASSCODE" line.
2. Press **ENTER key** to display

SET PASSCODE? (DISABLED)

. Use **↓ and ↑ keys** to view both choices (DISABLED or ENABLED).
3. With the desired choice displayed, press **ENTER key** to enter this selection.

4.6 Configuration Setting Summary

Table B lists all configuration settings and their entry ranges/choices and factory defaults, categorized by basic functions.

Table B -- ANALYZER CONFIGURATION SETTINGS (RANGES/CHOICES and DEFAULTS)			
Displayed Screen Title	Entry Range or Choices (where applicable)	Factory Default	Your Setting
LANGUAGE Configuration Setting			
LANGUAGE?	ENGLISH, FRENCH, GERMAN, SPANISH, etc.	ENGLISH	
SENSOR Configuration Settings			
SET FILTER?	0-60 seconds	30 seconds	
PULSE SUPPRESS?	OFF or ON	OFF	
ENTER NOTE?	Enter up to eight characters to replace TRCN-96 SYSTEM	TRCN-96 SYSTEM	
Analog OUTPUT Configuration Settings			
SET 4mA VALUE?	0.000-100.0 NTU	0.000 NTU	
SET 20mA VALUE?	0.000-100.0 NTU	100.0 NTU	
SET TRANSFER?	0-20 mA or 4-20 mA	Outputs 1 and 2: 12 mA	
SET FILTER?	0-60 seconds	Outputs 1 and 2: 0 seconds	
SCALE 0mA/4mA?	0 mA or 4 mA	Outputs 1 and 2: 4 mA	
RELAY Configuration Settings			
Settings Common To ALARM and CONTROL Relays:			
SET FUNCTION?	ALARM, CONTROL, or STATUS	Relays A and B: ALARM Relay C: STATUS -- WARN Relay D: STATUS -- FAIL	
SET TRANSFER?	DE-ENERGIZED or ENERGIZED	Relays A and B: DE-ENERGIZED	
OFF DELAY?	0-300 seconds	0 seconds	
ON DELAY?	0-300 seconds	0 seconds	
Settings For ALARM Relays Only:			
LOW ALARM?	0.000-100.0 NTU	0.000 NTU	
HIGH ALARM?	0.000-100.0 NTU	100.0 NTU	
LOW DEADBAND?	0-10% of meas. Range in which setpoint resides	0.000 NTU	
HIGH DEADBAND?	0-10% of meas. Range in which setpoint resides	0.000 NTU	
Settings For CONTROL Relays Only:			
PHASE?	HIGH or LOW	Relays A and B: HIGH	
SET SETPOINT?	0.000-100.0 NTU	100.0 NTU	
DEADBAND?	0-10% of meas. Range in which setpoint resides	0.000 NTU	
OVERFEED TIMER?	0-999.9 minutes	0 minutes	
Setting For STATUS Relays Only:			
ACTIVATION?	FAIL, WARN or ALL	STATUS Relays A and B: ALL STATUS Relay C: WARN STATUS Relay D: FAIL	
PASSCODE Configuration Setting			
SET PASSCODE?	DISABLED or ENABLED	DISABLED	
TEST/MAINTENANCE Simulation Function Setting			
SIM SENSOR?	0.000-100.0 NTU	Present measured turbidity value	

SECTION 5

CALIBRATING THE ANALYZER

5.1 Things to Know About Calibration

The TRCN-96 SYSTEM™ Low-range Turbidity Meter System can be calibrated using one of three methods:

- **PRIMARY CAL:** Requires entering a primary standard value of a formazin suspension.
- **CALIBRATION STANDARD CUBE:** Requires inserting an optional TR-8220 into the sensor flow chamber and entering its factory-certified standard value.
- **SAMPLE CAL:** Requires entering a sample value determined by laboratory analysis or calibrated portable meter.

You can conveniently verify system calibration at any time, regardless of the method used, with the optional Omega Engineering TR-8220 calibration standard cube. Refer to Part Three, Section 6.2 for complete details.



NOTE: *The sensor is equipped with long-lasting light sources and detectors. If these components are eventually replaced, always re-calibrate the system using the appropriate method to ensure measurement accuracy. Also, re-calibrate if the cable length between sensor and analyzer changes.*

The mA value for each analog output can also be calibrated (Section 5.5).



NOTE: *When the passcode feature is enabled (Section 4.5), you must successfully enter the passcode before attempting to calibrate the analyzer.*

*An in-progress calibration can always be aborted by pressing the **ESC** key. After the "ABORT: YES?" screen appears, do one of the following:*

- Press **ENTER** key to abort. After the "CONFIRM ACTIVE?" screen appears, press **ENTER** key to return the analog outputs and relays to their active states (MEASURE screen appears).
- Press **↑** or **↓** key to choose the "ABORT: NO?" screen, and press **ENTER** key to continue calibration.



Calibration Tip! If at any time during calibration, the "CONFIRM FAILURE?" screen appears, press **ENTER** key to confirm. Then, use \uparrow or \downarrow key to select between "CAL REPEAT?" or "CAL EXIT?" and do one of the following:

- With the "CAL REPEAT?" screen selected, press **ENTER** key to repeat calibration.
- With the "CAL EXIT?" screen selected, press **ENTER** key. After the "CONFIRM ACTIVE?" screen appears, press **ENTER** key to return the analog outputs and relays to their active states (MEASURE screen appears).

5.2 PRIMARY CAL Method (requires formazin suspension)

Preparing Formazin Solution

This calibration method requires you to first fill the sensor flow chamber with a primary standard (formazin suspension) and then enter its known value. Since formazin is the recommended primary standard, it is used in the instructions for this method.

Prepare 2000 milliliters of **20 NTU or higher** formazin suspension (USEPA requires 40 NTU to comply with Omega Engineering Method 2) using the following laboratory procedure:

1. Make the dilution water:

To obtain high-purity, low turbidity water for dilutions, pass distilled water through a 0.2 micron filter. Rinse the flask at least twice with filtered water before collecting the dilution water.

2. Make the stock turbidity suspension:

WARNING:

HYDRAZINE SULFATE IS A KNOWN CARCINOGEN. TAKE PRECAUTIONS TO AVOID INHALATION, INGESTION, AND SKIN CONTACT.

- A. **SOLUTION 1:** Dissolve 5.00 grams of reagent-grade hydrazine sulfate, $(\text{NH}_2)_2\text{H}_2\text{SO}_4$, in distilled water and dilute to 500 ml in a volumetric flask.

- B. **SOLUTION 2:** Dissolve 50.00 grams of reagent-grade hexamethylenetetramine, $(\text{CH}_2)_6\text{N}_4$, in distilled water and dilute to 500 ml in a volumetric flask.
- C. In a flask, mix 50.0 ml of SOLUTION 1 and 50.0 ml of SOLUTION 2. Let this mixture stabilize for 24 hours at 25°C , $\pm 3^\circ\text{C}$. The resultant mixture is a 4000 NTU stock turbidity suspension. Transfer the stock suspension to an amber glass (or other UV-light blocking) bottle for storage. Make dilutions from this stock suspension. When properly stored, this stock suspension should remain stable for up to one year.
3. Make the standard formazin suspension for calibration:
- **20 NTU Standard Suspension:** Use filtered dilution water to dilute 10 ml of 4000 NTU stock suspension to 2000 ml.
 - **40 NTU Standard Suspension:** Use filtered dilution water to dilute 20 ml of 4000 NTU stock suspension to 2000 ml.



Calibration Tip! Use only freshly prepared, properly stored, and carefully measured formazin suspension. Formazin tends to flocculate over time, causing inaccurate readings. Formazin suspensions must be equally distributed within the flask. Gently swirl the flask several times. Do not vigorously shake the flask which could introduce air bubbles that may falsely increase readings.

Filling Sensor

1. **Recommendation:** Before filling the sensor with a formazin suspension (primary standard), hold the analyzer analog outputs at their present values or transfer them to preset values to ensure a safe condition for any connected devices.

```

MAIN MENU
▶CALIBRATE
▶CONFIGURE
▶TEST/MAINT
◀EXIT
  
```

- A. Press **MENU** key to display _____ .

- B. With the "CALIBRATE" line selected (reverse video),

```

CALIBRATE
▶SENSOR
▶CAL OUTPUTS
◀EXIT
  
```

press **ENTER** key to display _____ .

9. Rinse sensor tubing a second time with another volume of primary standard formazin suspension and drain again (a repeat of step 5).
10. Fill sensor tubing a third time with another volume of primary standard formazin suspension until it can be seen in the clear SIGHT TUBE.

Entering Value

After the sensor is properly filled, enter the exact known value of the suspension.

1. With the

PRIMARY CAL: SAMPLE READY?

 screen displayed and the sensor filled with primary standard formazin suspension, press **ENTER** key to confirm. This active

XX.XXX NTU READING STABLE?

 screen appears showing the measurement reading.
2. Wait for the reading to stabilize which may take up to 15 minutes. Then press **ENTER** key. The "PLEASE WAIT" screen may appear if the reading is still too unstable. After the reading has stabilized, this static

PRIMARY CAL? (XX.XX NTU)

 screen appears showing the "last-entered" calibration value.
3. Use **↑** and **↓** keys to adjust this displayed value to exactly match the known NTU value of the primary standard formazin suspension.
4. Press **ENTER** key to enter the value and complete calibration ("PRIMARY CAL: CONFIRM CAL OK?" screen appears).

Resuming Operation

To resume normal measurement operation:

1. Drain the sensor flow chamber as described in the previous "Filling Sensor" subsection in step 4.
2. Turn the sensor's 3-way valve handle to the **OPERATE** position as shown by the label at the base of the flow chamber (⇒ points towards INLET fitting).
3. If using the recommended isolation valve downstream of the Model TRCN-96 Sensor OUTLET fitting, make sure it is open to allow process flow.

4. Press **ENTER** key to display the active measurement reading on the "CONFIRM ACTIVE?" output status screen. When the reading corresponds to the actual typical process value, press **ENTER** key again to return the analog outputs and relays to their active states (MEASURE screen appears).

This completes "PRIMARY CAL" calibration. The system is now ready for normal measurement operation.

5.3 Calibration Standard Cube Method (requires optional TR-8220 cube)

Inserting the cube

This calibration method requires you to first insert an optional Omega Engineering calibration standard cube into the sensor flow chamber and then enter its known value. This unique turbid glass cube has a factory-certified, 100% reproducible NTU calibration value that is not affected by light, temperature, or aging.

1. **Recommendation:** Before inserting the TR-8220 cube into the sensor, hold the analyzer analog outputs at their present values or transfer them to preset values to ensure a safe condition for any connected devices.

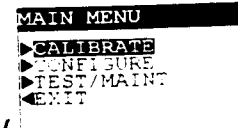

A. Press **MENU** key to display

B. With the "CALIBRATE" line selected (shown in reverse video), press **ENTER** key to display

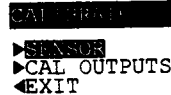

C. With the "SENSOR" line selected, press **ENTER**



key to display

D. Use **↓** key to select the "CUBE CAL" line and press

ENTER key to display . Use **↑** or **↓** key to view the three states that the analog outputs (and relays) can be in during calibration:

- **HOLD OUTPUTS:** Holds their present mA values.
- **XFER OUTPUTS:** Transfers to preset mA values.
- **ACTIVE OUTPUTS:** Responds to measured turbidity.

E. With the desired choice displayed, press **ENTER key** to enter this selection.

2. Turn the sensor's 3-way valve handle to the **CALIBRATE** position as shown by the label at the base of the flow chamber (↔ points towards funnel hose).
3. If the recommended isolation valve is used downstream of the sensor OUTLET, open the valve to atmospheric pressure to improve draining.
4. Drain any remaining process from the sensor by removing the funnel from its holder and lowering it below the sensor height. When drained, replace funnel into holder.
5. Remove the flow chamber cover and baffle assembly from the Model TRCN-96 Sensor flow chamber. Refer to Figure 4-1 (standard sensor design) or Figure 4-2 (high pressure sensor design) for assembly details.
6. Wipe away all moisture from inside the chamber with a clean, dry, soft cloth.
7. Wipe the light source and detector windows clean using a clean, dry, soft cloth.
8. Note the factory-certified value on TR-8220 cube, and insert the cube into the sensor in place of the baffle assembly. Without replacing the flow chamber cover, close the sensor enclosure door.

Entering Value

After the cube is properly inserted in the sensor flow chamber, enter its factory-certified value.

1. With the

CUBE CAL: SAMPLE READY?

 screen displayed and the cube inserted in the sensor, press **ENTER key** to confirm. This active

XX.XXX NTU READING STABLE?

 screen appears showing the measurement reading.

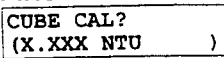
2. Wait for the reading to stabilize which may take up to 15 minutes. Then press **ENTER key**. The "PLEASE WAIT" screen may appear if the reading is still too unstable. After the reading has stabilized, this static  screen appears showing the "last-entered" calibration value.
3. Use **↑ and ↓ keys** to adjust this displayed value to exactly match the factory-certified TR-8220 cube value.
4. Press **ENTER key** to enter the value and complete calibration (CUBE CAL: CONFIRM CAL OK?" screen appears).

Resuming Operation

To resume normal measurement operation:

1. Remove the cube, re-install the baffle assembly, and replace the flow chamber cover. Make sure the cover O-ring is well lubricated with the supplied silicone lubricant. If not, the cover may be difficult to remove the next time.
2. Turn the sensor's 3-way valve handle to the **OPERATE** position as shown by the label at the base of the flow chamber (⇒ points towards INLET fitting).
3. Press **ENTER key** to display the active measurement reading on the "CONFIRM ACTIVE?" output status screen. When the reading corresponds to the actual typical process value, press **ENTER key** again to return the analog outputs and relays to their active states (MEASURE screen appears).

This completes TR-8220 cube calibration. The system is now ready for normal measurement operation.

5.4 SAMPLE CAL Method (requires sample with value determined by laboratory analysis or portable meter)

This calibration method requires you to first obtain a process sample, determine its NTU value using laboratory analysis or a comparison reading, and then enter its known value.

1. With the process flowing through the sensor, press

```

MAIN MENU
▶CALIBRATE
▶CONFIGURE
▶TEST/MAINT
◀EXIT
      
```

MENU key to display _____ .
2. With the “CALIBRATE” line selected (shown in reverse

```

CALIBRATE
▶SENSOR
▶CAL OUTPUTS
◀EXIT
      
```

 video), press **ENTER key** to display _____ .
3. With the “SENSOR” line selected, press **ENTER key** to

```

SENSOR
▶PRIVACY CAL
▶CUBE CAL
▶SAMPLE CAL
◀EXIT
      
```

 display _____ .
4. Use ↓ **key** to select the “SAMPLE CAL” line and press **ENTER key** to display

```

SAMPLE CAL?
(HOLD OUTPUTS )
      
```

 . Use ↑ **or** ↓ **key** to view the three states that the analog outputs (and relays) can be in during calibration:
 - **HOLD OUTPUTS:** Holds their present mA values.
 - **XFER OUTPUTS:** Transfers to preset mA values.
 - **ACTIVE OUTPUTS:** Responds to measured turbidity.
5. With the desired choice displayed, press **ENTER key** to enter this selection.
6. With the

```

SAMPLE CAL:
SAMPLE READY?
      
```

 screen displayed and the process flowing through the sensor, press **ENTER key** to confirm. This active

```

XX.XXX NTU
READING STABLE?
      
```

 screen appears showing the measurement reading.
7. Wait for the reading to stabilize which may take up to 15 minutes. Then press **ENTER key**. The “PLEASE WAIT” screen may appear if the reading is still too unstable. After the reading has stabilized, this static

```

SAMPLE CAL?
(X.XXX NTU )
      
```

 screen appears showing the “last-entered” calibration value.
8. Obtain a process sample and determine its NTU value using laboratory analysis or a calibrated portable meter.

9. With the static

SAMPLE CAL? (X.XXX NTU)

 screen displayed, use **↑** and **↓** keys to adjust the displayed value to exactly match the known NTU value of the process sample.
10. Press **ENTER** key to enter the value and complete calibration ("SAMPLE CAL: CONFIRM CAL OK?" screen appears).
11. Press **ENTER** key to display the active measurement reading on the "CONFIRM ACTIVE?" output status screen. When the reading corresponds to the actual typical process value, press **ENTER** key again to return the analog outputs and relays to their active states (MEASURE screen appears).

This completes "SAMPLE CAL" calibration.

5.5 Analog Outputs (1 and 2) Calibration



The analyzer analog outputs are factory-calibrated. However, they can be re-calibrated at any time if desired. **This procedure calibrates Output 1. Calibrate Output 2 in the same way using its respective menu screens.**

NOTE: When the passcode feature is enabled (Section 4.5), you must successfully enter the passcode before attempting to calibrate the analog outputs.

When an output is configured to be 0-20 mA, the analyzer will calibrate the 4 mA and 20 mA values (not the 0 mA value). Also, the analyzer adjustment range for output values during calibration is ± 2 mA.

```

MAIN MENU
▶CALIBRATE
▶CONFIGURE
▶TEST/MAINT
◀EXIT
    
```

1. Press **MENU** key to display _____.
2. With the "CALIBRATE" line selected (shown in reverse

```

CALIBRATE
▶SENSOR
▶CAL OUTPUTS
◀EXIT
    
```

video), press **ENTER** key to display _____.

3. Use **↓** key to select the "CAL OUTPUTS" line, and

```

CAL OUTPUT
▶CAL OUTPUT 1
▶CAL OUTPUT 2
◀EXIT
    
```

press **ENTER** key to display _____.

4. With the "CAL OUTPUT 1" line selected, press

```

CAL OUTPUT 1
▶CAL OUT 1 4mA
▶CAL OUT 1 20mA
◀EXIT
  
```

ENTER key to display _____ .

5. With the "CAL OUT 1 4 mA" line selected, press

ENTER key to display a screen like

CAL OUT 1 4mA?
(XXX)

 .

The displayed value is "counts" -- not mA -- that dynamically change when the output is adjusted.

6. Use a calibrated digital multimeter to measure Output 1's actual minimum value provided at Terminals 2 and 3 on TB1.

7. Use ⇨ and ⇩ keys (coarse adjust) and ↑ and ↓ keys (fine adjust) to adjust Output 1's minimum value to read exactly "4.00 mA" on the digital multimeter -- not the analyzer display.

8. Press **ENTER** key to complete calibration of the minimum endpoint value.

```

CAL OUTPUT 1
▶CAL OUT 1 4mA
▶CAL OUT 1 20mA
◀EXIT
  
```

9. After the _____ screen re-appears, use ↓ key to select the "CAL OUT 1 20 mA" line, and press

ENTER key to display a screen like

CAL OUT 1 20mA?
(XXXX)

 .

Once again the displayed value is "counts" -- not mA -- that dynamically change when the output is adjusted.

10. Use a calibrated digital multimeter to measure Output 1's actual maximum value.

11. Use ⇨ and ⇩ keys (coarse adjust) and ↑ and ↓ keys (fine adjust) to adjust Output 1's maximum value to read exactly "20.00 mA" on the digital multimeter -- not the analyzer display.

12. Press **ENTER** key to complete calibration of the maximum endpoint value.

This completes Output 1 calibration.

SECTION 6

TEST/MAINTENANCE

The analyzer has TEST/MAINT menu screens to:

- Check system status of analyzer, sensor, and relays.
- Check calibration/hold analog outputs at present values.
- Manually reset all relay overfeed timers.
- Provide analog output test signals to confirm operation of connected devices.
- Test relay operation (energize or de-energize).
- Identify turbidity sensor type.
- Identify analyzer EPROM version.
- Simulate a measured turbidity signal to exercise the measurement loop.
- Reset all configuration values to factory-set defaults.

6.1 STATUS Checking (analyzer, sensor, and relays)

The system diagnostic capabilities of the analyzer enable you to check the operating status of the analyzer, sensor, and relays. The MEASURE screen will flash the "WARNING CHECK STATUS" message when an abnormal system diagnostic condition has been detected. To determine the condition causing the warning, display the "STATUS" screens:

```

MAIN MENU
▶CALIBRATE
▶CONFIGURE
▶TEST/MAINT
◀EXIT
  
```

1. Press **MENU** key to display  , and use **↓** key to select the "TEST/MAINT" line.

```

TEST/MAINT
▶STATUS
▶CHECK CAL/HOLD
▶OVERFEED RESET
▶OUTPUT 1
▶OUTPUT 2
▶RELAY A
▶RELAY B
▶RELAY C
▶RELAY D
▶SENSOR TYPE
▶EPROM VERSION
▶SIM SENSOR
▶RESET DEFAULTS
◀EXIT
  
```

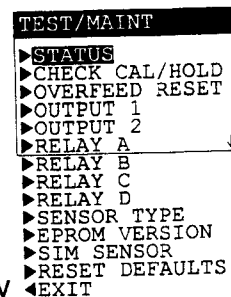
2. Press **ENTER** key to display  .
3. With the "STATUS" line selected, press **ENTER** key to display the "STATUS: ANALYZER OK" screen. This

screen confirms that the analyzer is operating properly. If "FAIL" appears, it may mean:

- EPROM failure (data is not valid).
 - Scaling card not present or not recognized.
 - Analog-to-digital converter not responding.
 - RAM failure.
 - Internal serial communications failure.
4. Press **ENTER key** once to view the "STATUS: SENSOR" screen. Sensor status indications can be:
 - CHAMBER OK -- Sensor is operating properly.
 - CHAMBER DIRTY -- Sensor flow chamber needs cleaning. Refer to Part Four, Section 1.1 for details.
 - CHAMBER UNKNOWN -- Sensor may be:
 - ✓ Disconnected or incorrectly wired to analyzer.
 - ✓ Providing a very noisy measurement signal.
 - ✓ Inoperative due to disconnected or incorrectly wired light source or detector.
 - ✓ Inoperative due to bad signal processing module.
 5. With the "STATUS: SENSOR" screen displayed, press **ENTER key** once to view the "STATUS: SOURCE 1" screen. Press **ENTER key** again to view the "STATUS: SOURCE 2" screen. Source status indications can be:
 - OK -- LED light source is operating properly.
 - FAIL -- LED light source may be disconnected, incorrectly wired, or inoperative. See Part Four, Section 1.3 for replacement details.
 6. With the "STATUS: SOURCE 2" screen displayed, press **ENTER key** once to view "STATUS: DETECT 1" screen. Press **ENTER key** again to view the "STATUS: DETECT 2" screen. Detector status indications can be:
 - OK -- Detector is operating properly.
 - FAIL -- Detector may be disconnected, incorrectly wired, or inoperative. See Part Four, Section 1.3 for replacement details.
 7. With the "STATUS: DETECT 2" screen displayed, press **ENTER key** once to view the "STATUS: RLY A" screen. Subsequent **ENTER key** presses display status screens for Relay B, C, and D. Relay status indications can be:

Status Indication	Meaning
ACTIVE (Relay energized; annunciator is on)	Control Relay: Measured value exceeds setpoint. Alarm Relay: Measured value exceeds low or high alarm point. Status Relay: Selected system diagnostic condition has been detected.
INACTIVE (Relay not energized; annunciator is off)	Control Relay: Measured value does not exceed setpoint. Alarm Relay: Measured value does not exceed low or high alarm point. Status Relay: Analyzer has not detected selected system diagnostic condition.
TIMEOUT (Relay not energized; annunciator blinks)	Control Relay: Overfeed timer has timed out; manually reset it. NOTE: <i>TIMEOUT only applies to control relays.</i>
COUNTING (Relay energized; annunciator is on)	Control Relay: Overfeed timer is counting, but has not timed out. NOTE: <i>COUNTING only applies to control relays.</i>

8. To end status checking, press **ESC** or **ENTER** key.

6.2 CHECK CAL/HOLD Outputs

The TRCN-96 SYSTEM™ system has a convenient feature to easily check calibration at any time, and to hold the analog outputs (1 and 2) at their present values, suspending operation of any connected devices. The calibration check, however, requires an optional TR-8220 cube.

```

TEST/MAINT
▶STATUS
▶CHECK CAL/HOLD
▶OVERFEED RESET
▶OUTPUT 1
▶OUTPUT 2
▶RELAY A
▶RELAY B
▶RELAY C
▶RELAY D
▶SENSOR TYPE
▶EPROM VERSION
▶SIM SENSOR
▶RESET DEFAULTS
◀EXIT

```

1. With the screen displayed, use **↓** key to select the "CHECK CAL/HOLD" line.
2. Press **ENTER** key to immediately hold the analog outputs ("OUTPUTS ON HOLD" screen appears, acknowledging that hold has occurred while showing the active measurement reading).



NOTE: If the keypad is not used within 30 minutes, the analog outputs will automatically change back to their active states and the display will return to the MEASURE screen.

3. Temporarily insert the cube:
 - A. Turn sensor's 3-way valve handle to the **CALIBRATE** position as shown by the label at the base of the flow chamber (⇐ points towards funnel hose).
 - B. If the recommended isolation valve is used downstream of the sensor OUTLET, open the valve to atmospheric pressure to improve draining.
 - C. Drain any remaining process from sensor by removing funnel from its holder and lowering it below the sensor height. When drained, replace funnel into holder.
 - D. Remove the flow chamber cover and baffle assembly from the sensor flow chamber. Refer to Figure 4-1 (standard sensor design) or Figure 4-2 (high pressure sensor design) for assembly details.
 - E. Wipe away all moisture from inside the chamber with a clean, dry, soft cloth.
 - F. Note the factory-certified value on the TR-8220 cube, and insert the cube into the sensor in place of the baffle assembly. Without replacing the flow chamber cover, close sensor enclosure door.
4. If the reading is within $\pm 10\%$ of the cube value, the system is "in calibration." If not, re-calibrate (see Part Three, Section 5.2, 5.3, or 5.4 for details).
5. After checking calibration, remove the TR-8220 cube and re-install the baffle assembly.
6. Replace the flow chamber cover. Make sure the cover O-ring is well lubricated with the supplied silicone lubricant. If not, the cover may be difficult to remove the next time.
7. Turn the sensor's 3-way valve handle to the **OPERATE** position as shown by the label at the base of the flow chamber (⇒ points towards INLET fitting).
8. Press **ENTER key** to display the active measurement reading on the "CONFIRM ACTIVE?" output status screen. When the reading corresponds to the actual typical process value and is stable, press **ENTER key** again to change the analog output states back to active.

6.3 OVERFEED RESET (relay timers)

When a relay overfeed timer “times out,” as indicated by its blinking annunciator, the timer must be manually reset using TEST/MAINT menu screens. The relay annunciator stops blinking after reset. **All overfeed timers are manually reset at once.**

```

TEST/MAINT
▶STATUS
▶CHECK CAL/HOLD
▶OVERFEED RESET
▶OUTPUT 1
▶OUTPUT 2
▶RELAY A
▶RELAY B
▶RELAY C
▶RELAY D
▶SENSOR TYPE
▶EPROM VERSION
▶SIM SENSOR
▶RESET DEFAULTS
◀EXIT
  
```

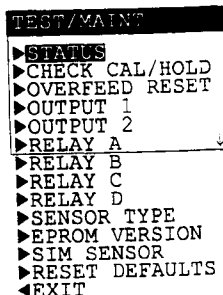
1. With the  screen displayed, use \downarrow key to select the “OVERFEED RESET” line.
2. Press **ENTER** key to display “OVERFEED RESET” screen.
3. Press **ENTER** key again to reset all relay overfeed timers at once (“OVERFEED RESET: DONE” screen appears, acknowledging reset has occurred).
4. To return to the “TEST/MAINT” top-level menu screen, press **ESC** or **ENTER** key.

6.4 OUTPUT (1 and 2) Analog Test Signals

The analyzer can provide analog output test signals of a desired mA value to confirm operation of connected devices. **This procedure provides an Output 1 test signal. Provide an Output 2 test signal in the same way using its respective menu screens.**

```

TEST/MAINT
▶STATUS
▶CHECK CAL/HOLD
▶OVERFEED RESET
▶OUTPUT 1
▶OUTPUT 2
▶RELAY A
▶RELAY B
▶RELAY C
▶RELAY D
▶SENSOR TYPE
▶EPROM VERSION
▶SIM SENSOR
▶RESET DEFAULTS
◀EXIT
  
```

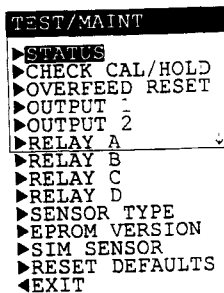
1. With the  screen displayed, use \downarrow key to select the “OUTPUT 1” line.
2. Press **ENTER** key to display a screen like

```

OUTPUT 1?
(XX.XXmA )
  
```



NOTE: The mA test signal for Output 1 is now active. Its value is shown on this screen.

- Adjust the displayed value to obtain the desired mA test signal. (Use \Rightarrow and \Leftarrow keys for coarse adjust; \Downarrow and \Uparrow keys for fine adjust.)
- To end the output test signal and return to the "TEST/MAINT" top-level menu screen, press **ESC** or **ENTER** key.

6.5 RELAY (A, B, C, and D) Operating Test

Relays A, B, C, and D can be tested to confirm their operation. **This procedure tests Relay A. Test other relays in the same way using their respective menu screens.**

```

TEST/MAINT
▶STATUS
▶CHECK CAL/HOLD
▶OVERFEED RESET
▶OUTPUT 1
▶OUTPUT 2
▶RELAY A
▶RELAY B
▶RELAY C
▶RELAY D
▶SENSOR TYPE
▶EPROM VERSION
▶SIM SENSOR
▶RESET DEFAULTS
◀EXIT
  
```

- With the screen displayed, use \Downarrow key to select the "RELAY A" line.
- Press **ENTER** key to display

```
RELAY A?
(ENERGIZE  )
```

. Relay A should be energized. Confirm this by checking the NO and NC relay output terminals with a continuity meter.
- Press \Uparrow or \Downarrow key once to display

```
RELAY A?
(DE-ENERGIZE  )
```

. Relay A should now be de-energized. Confirm this by checking the NO and NC relay output terminals with a continuity meter.
- To end this test and return to the "TEST/MAINT" top-level menu screen, press **ESC** or **ENTER** key.

6.6 SENSOR TYPE Checking

You can check the type of sensor used with your analyzer.

```

TEST/MAINT
▶STATUS
▶CHECK CAL/HOLD
▶OVERFEED RESET
▶OUTPUT 1
▶OUTPUT 2
▶RELAY A
▶RELAY B
▶RELAY C
▶RELAY D
▶SENSOR TYPE
▶EPROM VERSION
▶SIM SENSOR
▶RESET DEFAULTS
◀EXIT
  
```

- With the screen displayed, use \Downarrow key to select the "SENSOR TYPE" line.

6.7 EPROM VERSION Checking

2. Press **ENTER** key to view the sensor type screen.
3. To return to the "TEST/MAINT" top-level menu screen, press **ESC** or **ENTER** key.

You can check the version of EPROM used in the analyzer.

```

TEST/MAINT
▶STATUS
▶CHECK CAL/HOLD
▶OVERFEED RESET
▶OUTPUT 1
▶OUTPUT 2
▶RELAY A
▶RELAY B
▶RELAY C
▶RELAY D
▶SENSOR TYPE
▶EPROM VERSION
▶SIM SENSOR
▶RESET DEFAULTS
◀EXIT
  
```

1. With the screen displayed, use **↓** key to select the "EPROM VERSION" line.
2. Press **ENTER** key to view the EPROM version screen.
3. To return to the "TEST/MAINT" top-level menu screen, press **ESC** or **ENTER** key.

6.8 SIM SENSOR Setting

You can simulate a measured turbidity value to make the relays and analog outputs respond accordingly.

```

TEST/MAINT
▶STATUS
▶CHECK CAL/HOLD
▶OVERFEED RESET
▶OUTPUT 1
▶OUTPUT 2
▶RELAY A
▶RELAY B
▶RELAY C
▶RELAY D
▶SENSOR TYPE
▶EPROM VERSION
▶SIM SENSOR
▶RESET DEFAULTS
◀EXIT
  
```

1. With the screen displayed, use **↓** key to select the "SIM SENSOR" line.
2. Press **ENTER** key to display a screen like

```

SIM SENSOR?
(X.XXX NTU )
  
```



NOTE: The value shown on this screen is now active, providing a corresponding mA value for both analog output signals. (The relays, depending on their configured settings, may also respond to this simulation value.)

3. Adjust the displayed simulation value to the desired value. (Use \Rightarrow **and** \Leftarrow **keys** for coarse adjust; \Updownarrow **and** \Downarrow **keys** for fine adjust.)
4. To end the simulation and return to the "TEST/MAINT" top-level menu screen, press **ESC** or **ENTER** key.

6.9 RESET DEFAULTS

You can conveniently reset all stored configuration settings, including calibration settings, simultaneously to factory-set defaults.

```

TEST/MAINT
▶STATUS
▶CHECK CAL/HOLD
▶OVERFEED RESET
▶OUTPUT 1
▶OUTPUT 2
▶RELAY A
▶RELAY B
▶RELAY C
▶RELAY D
▶SENSOR TYPE
▶EPROM VERSION
▶SIM SENSOR
▶RESET DEFAULTS
◀EXIT
  
```

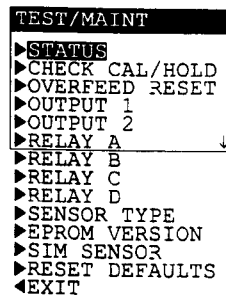
1. With the  screen displayed, use \Downarrow **key** to select the "RESET DEFAULTS" line.
2. Press **ENTER** key to display the "RESET DEFAULTS: ARE YOU SURE?" screen, asking if you really intend to perform this extreme action. (If you want to abort this action, press **ESC** key now.)
3. Press **ENTER** key to reset all stored configuration settings to factory defaults ("RESET DEFAULTS: DONE" screen appears, acknowledging reset has occurred).
4. To return to the "TEST/MAINT" top-level menu screen, press **ESC** or **ENTER** key.

SECTION 7

RELAY OVERFEED TIMER FEATURE

The useful relay overfeed timer feature, **only available to a CONTROL function relay**, is described in more detail in this section.

7.1 Why Use an Overfeed Timer?

Suppose that you configure a CONTROL relay with a high phase to operate in response to increasing measured turbidity. The CONTROL relay will then turn on whenever the measured turbidity exceeds its preset setpoint. When the measured turbidity decreases below the setpoint by an amount you preset (the deadband setting), the relay will turn off. But what if a damaged sensor or a process upset condition keeps the measured turbidity above the setpoint or deadband setting? The control element (valve, pump, etc.) switched by that relay would then continue to operate. Depending on the application control scheme, this may excessively dispense costly chemical additives or overly drain or divert the process. Also, the control element itself could be damaged due to excessive continuous or unusual operation such as a pump that is running dry. The useful overfeed timer prevents undesirable conditions like these from happening. It restricts how long the relay and its connected control element will remain on regardless of conditions.

7.2 Configuring Relay Overfeed Timers

To set a relay overfeed timer, use its respective configuration menu screen. The time you set to restrict how long the relay stays on (0-999.9 minutes) should be just enough to provide acceptable results. An excessive setting may waste chemicals or the process itself. Initially, set this time as an estimate. Then, by experimenting and observing the response, periodically "fine tune" to optimize the setting.

7.3 Overfeed Timer "Timeout" Operation

When a CONTROL relay is on and its overfeed timer "times out," its annunciator will blink. This indicates that the relay is now off and will remain off until you manually reset the overfeed timer. After reset, the relay annunciator stops blinking. (All overfeed timers are reset simultaneously.)

7.4 Resetting Overfeed Timers

To manually reset all relay overfeed timers, please refer to Part Three, Section 6.3.

7.5 Interactions with Other Analyzer Functions

A relay overfeed timer can, and often will, interact with other analyzer functions while those functions are in use. Table C on the next page explains common overfeed timer interactions.

Table C – RELAY OVERFEED TIMER INTERACTIONS WITH OTHER ANALYZER FUNCTIONS		
Function Conditions		Resulting Action of Overfeed Timer
Manually Holding Relay Operation (when outputs are held at start of calibration)		
Off relay held in "off"	Overfeed timer was off	Overfeed timer remains off. After you change back to ACTIVE from the HOLD mode, the overfeed timer will remain off until the measured value (or a value you simulate) causes the relay to turn on.
On relay held in "on"	Overfeed timer was counting	Overfeed timer continues its "count down" until it turns the relay off. If you release HOLD <u>before</u> the timer "times out," the timer continues its "count down" until it turns the relay off or the timer automatically resets when the measured value (or a value you simulate) causes the relay to turn off. If you release HOLD <u>after</u> the timer has "timed out," it must be manually reset (Part Three, Section 6.3).
On relay held in "on"	Overfeed timer was timed out	Overfeed timer remains off which keeps the relay turned off. You must manually reset the timer (Part Three, Section 6.3).
Manually Transferring Relay Operation (when outputs are transferred at start of calibration)		
Off relay is transferred to "on"	Overfeed timer was off	Overfeed timer starts its "count down" until it turns the relay off. After you change the "on" relay back to "off," the overfeed timer automatically resets.
On relay is transferred to "off"	Overfeed timer was counting	Overfeed timer automatically resets. After you change the "off" relay back to "on," the overfeed timer starts its "count down" until it turns the relay off, or the timer automatically resets again when the measured value (or a value you simulate) causes the relay to turn off.
On relay is transferred to "off"	Overfeed timer was timed out	
Manually Testing Relay Operation (using TEST/MAINTENANCE menu screens)		
Off relay is changed to "on"	Overfeed timer was off	Overfeed timer starts its "count down" until it turns the relay off. After you change the "on" relay back to "off," the overfeed timer automatically resets.
On relay is changed to "off"	Overfeed timer was counting	Overfeed timer automatically resets. After you change the "off" relay back to "on," the overfeed timer starts its "count down" until it turns the relay off, or the timer automatically resets again when the measured value (or a value you simulate) causes the relay to turn off.
On relay is changed to "off"	Overfeed timer was timed out	
Operating a Relay By Simulating a Value (using TEST/MAINTENANCE menu screens)		
Off relay is turned "on" by simulated value	Overfeed timer was off	Overfeed timer starts its "count down" until it turns the relay off. After you change the "on" relay back to "off," the overfeed timer automatically resets.
On relay is turned "off" by simulated value	Overfeed timer was counting	Overfeed timer automatically resets. After you change the "off" relay back to "on," the overfeed timer starts its "count down" until it turns the relay off, or the timer automatically resets again when the measured value (or a value you simulate) causes the relay to turn off.
On relay is turned "off" by simulation value	Overfeed timer was timed out	

PART FOUR - SERVICE AND MAINTENANCE

SECTION 1

GENERAL INFORMATION

1.1 Cleaning Sensor Flow Chamber

1. Open the Model TRCN-96 Sensor enclosure door to access the flow chamber.
2. After draining the sensor, remove the flow chamber cover by turning it 1/8 turn counterclockwise to disengage its four tabs, and lift it straight off the chamber.

NOTE: For high pressure design sensor (Figure 4-2), remove flow chamber cover locking and window by unscrewing locking counterclockwise.

3. Remove the baffle assembly. It is "keyed" with a slot and guide rib on its left side to fit only one way in the flow chamber.

NOTE: The high pressure design sensor uses the same baffle assembly, but this assembly is "keyed" with a rod and hole -- not a slot and guide rib.

4. Wipe the inside surface of the flow chamber with a soft, clean, damp cloth.

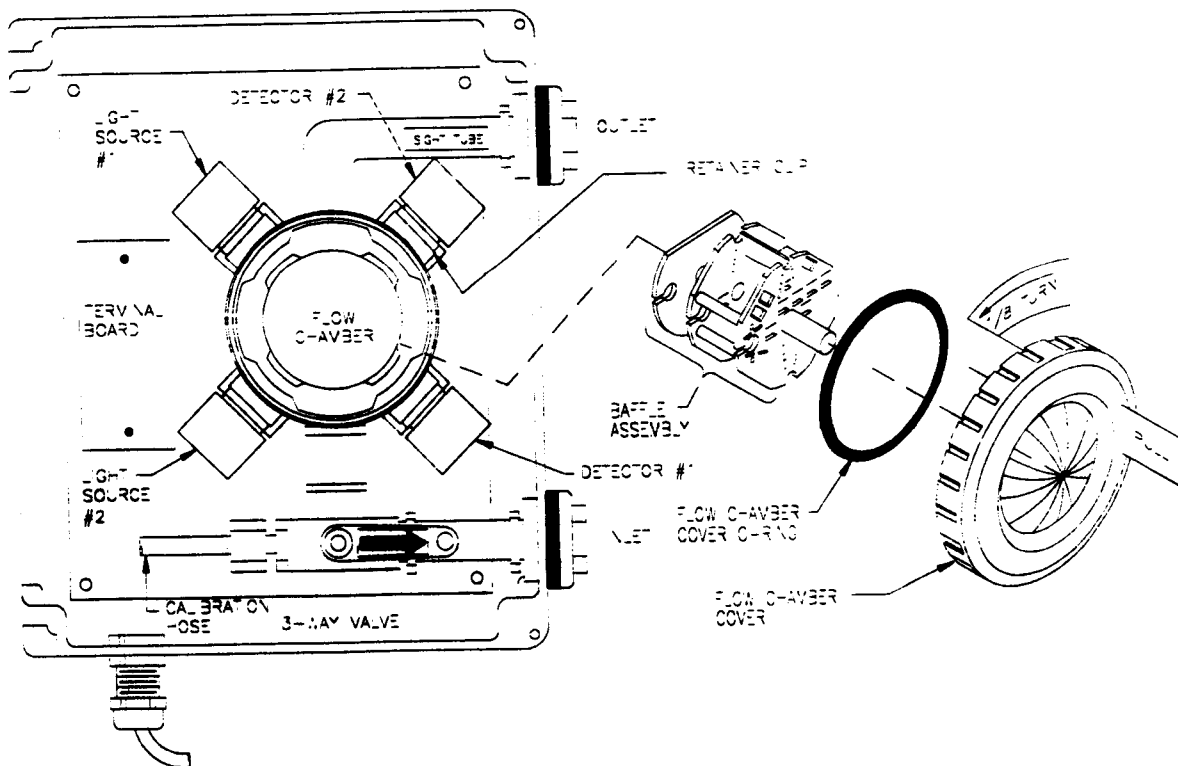

FIGURE 4-1 Standard Design Sensor -- Component Details

5. Rinse the baffle assembly with clean water. Wipe it off with a clean dry cloth if necessary.
6. Insert the baffle assembly into the flow chamber and replace the cover (for high pressure design sensor, replace O-ring, window, and locking).



NOTE: Make sure the cover O-ring is well lubricated with the supplied lubricant, and properly seated before tightening the cover or locking. If not, the cover may be difficult to remove next time.

1.2 Cleaning Optional TR-8220 cube

Recommendation: When not in use, properly store the TR-8220 cube inside its protective box in a cool, dry place.

If dirt or dust accumulates on the glass cube, **do not touch its surface with your fingers**. Finger oil will change its certified value. Dip the cube assembly in isopropyl alcohol to remove dust and finger oil. Use compressed air or a soft, clean optical cloth to dry the cube.

CAUTION:

DO NOT WIPE THE GLASS CUBE WITH TISSUES OR PAPER TOWELS. SMALL WOOD FIBERS FOUND IN THESE PRODUCTS WILL SCRATCH THE GLASS SURFACE OF THE CUBE WHICH MAY CHANGE ITS CERTIFIED VALUE.

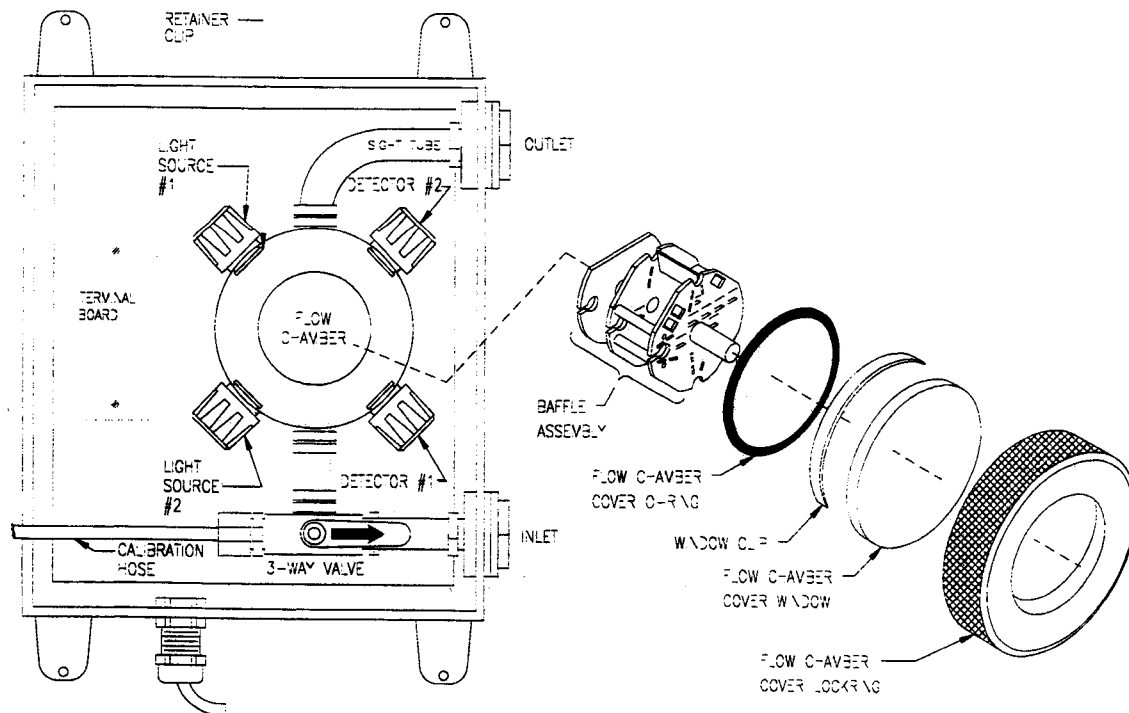

FIGURE 4-2 High Pressure Design Sensor -- Component Details

1.3 Replacing Sensor Light Source or Detector

Removing Inoperative Part



When the TEST/MAINT "STATUS: SOURCE 1 (or 2)" screen or "STATUS: DETECT 1 (or 2)" screen indicates "FAIL," the respective sensor LED light source or detector may be disconnected, incorrectly wired, or inoperative.

1. Open the Model TRCN-96 Sensor enclosure door to access the inoperative light source or detector.
2. After draining the sensor, remove the flow chamber cover by turning it 1/8 turn counterclockwise to disengage its four tabs, and lift it straight off the chamber.

NOTE: For high pressure design sensor (Figure 4-2), remove the flow chamber cover lockring and window by unscrewing the lockring counterclockwise.

3. Remove the black retainer clip from its slot in the flow chamber.
4. Extract the inoperative light source or detector from its receptacle.



NOTE: Extraction may be difficult because light sources and detectors have double O-ring seals. To ease removal, grasp the component by hand and twist it back and forth while extracting it.

5. Disconnect the wires of the inoperative light source or detector from the sensor terminal board.

- - - - # - - - -

Installing New Part



1. Carefully replace the new light source or detector assembly into its receptacle. Refer to Part Five -- Spare Parts -- for the Omega Engineering assembly part numbers.

NOTE: Lubricate O-rings with the lubricant supplied to help ease the component into place. Make sure the light source or detector is fully inserted.

2. Replace the black retainer clip to secure the new light source or detector.
3. Refer to Figure 4-3 and connect its wires, by color, to the sensor terminal board.

4. Replace the flow chamber cover. (For high pressure design sensor, replace the O-ring, window, and lockring.)



NOTE: Make sure the cover O-ring is well lubricated with the supplied lubricant, and properly seated before tightening the cover or lockring. If not, the cover may be difficult to remove next time.

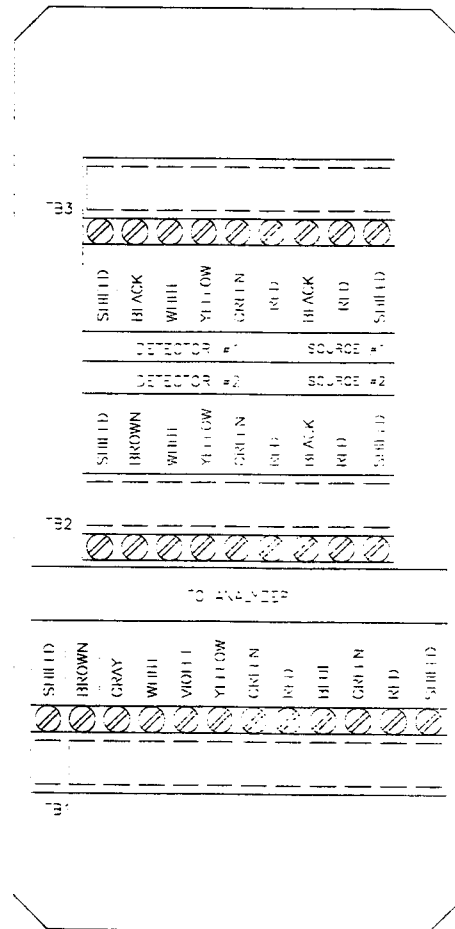

Figure 4-3 Turbidity Sensor Terminal Block Designations

Re-calibrating
Measurement
System

After replacing any light source(s) or detector(s), always re-calibrate the measurement system using the appropriate method. Refer to Part Three, Section 5 for details.

1.4 Replacing Fuse(s)

The analyzer is equipped with two board-mounted fuses (type T slow-blow; 5 mm x 20 mm size). Fuse values are shown by the fuses (Figure 2-8 or 2-9). The fuses protect the 115 and 230 volt line power circuits.

WARNING:

DISCONNECT LINE POWER TO AVOID THE POSSIBILITY OF ELECTRICAL SHOCK.

1. After disconnecting line power, open the analyzer door and locate the fuses (shown in Figure 2-8 or 2-9).
2. Remove the blown fuse and replace it with a Omega Engineering fuse or an equivalent.
3. Reconnect line power and close the analyzer door.

1.5 Replacing Relays

The analyzer relays are soldered into a complex, multi-layered circuit board. To avoid the possibility of damaging this board while attempting to replace a relay:

- Simply return the complete analyzer to the Omega Engineering Customer Service Dept. or your local factory-authorized service organization for relay replacement.

-- or --

- Replace the complete scaling board assembly containing the relays. Refer to Part Five -- Spare Parts -- for the Omega Engineering scaling board assembly part number.

1.6 Inspecting Sensor Cable

If a measurement problem exists and you suspect the sensor cable, inspect it for physical damage. If an interconnect cable is used, check the junction box, then disconnect the cable at both ends (sensor and analyzer) and, using an ohmmeter, check its wires for continuity and internal shorts.

SECTION 2

PRESERVING MEASUREMENT ACCURACY

2.1 Eliminating Bubbles in Sensor Flow Chamber

Restricting
Sensor Outlet

Two kinds of air or gas bubbles may exist in the sample: those that can be seen and those that cannot. Visible bubbles are created by mixing liquid and air. For example, water falling down or flowing through a pipe containing air will form bubbles. Bubbles that cannot be seen in liquid, but that do form and become visible in the sensor flow chamber are absorbed in the liquid. This can occur naturally or be the result of human intervention such as when ozone is injected into water to act as a disinfectant.

To remove visible bubbles in liquid, a bubble trap may be necessary. To minimize the effect of bubbles that cannot be seen, but that eventually form on the flow chamber windows, the liquid must be pressurized while it is being measured. This is easily accomplished by restricting the outflow from the Model TRCN-96 Sensor turbidity sensor. To do this:

1. Maintain the flow rate through the sensor within its specified limits (0.05 to 7 GPM).
2. Install a flow restrictor into the sensor outlet line and adjust it until flow is slightly reduced.
3. Close the 3-way valve to stop flow through the sensor.
4. Drain the flow chamber using the 3-way valve and calibration funnel.
5. Slowly open the 3-way valve to allow the flow chamber to slowly fill with sample liquid.

The above procedure should ensure bubble-free operation.

Using an External
Bubble Trap

For low sample flow rates (less than 0.5 GPM), the Model TRCN-96 Sensor turbidity sensor has a built-in bubble trap to minimize air accumulation in the flow chamber. For higher flow rates, it is recommended to use an external bubble trap/stilling chamber (Omega Engineering part number 80A1020) to collect and vent off air or gas from the liquid. The bubble trap must be installed vertically (air vent upward) and upstream of the sensor. (The air vent on Omega Engineering's external bubble trap/stilling chamber can be opened or closed. Bubbles remain in solution when the vent is closed, or are vented off when it is opened.)

2.2 Keeping Flow Chamber Clean



Periodically, it is recommended to remove the bubble trap drain plug to allow any accumulate sediment sludge to drain.

The TRCN-96 SYSTEM™ Low-range Turbidity Meter System has reactive diagnostics to alert you when the sensor flow chamber needs cleaning. When an abnormal system diagnostic condition has been detected, the MEASURE screen will flash the "WARNING CHECK STATUS" message. Depending on the selected activation mode for a STATUS relay (FAIL, WARN or ALL), this may or may not automatically energize a STATUS relay corresponding to that specific type of condition. To determine if the sensor needs cleaning, display the "STATUS: SENSOR" screen in the TEST/MAINT menu branch. When this screen indicates:

- CHAMBER DIRTY -- System diagnostics has detected degrading measurement performance, typically caused by dirty flow chamber windows. Refer to Part Four, Section 1.1 for instructions to clean the flow chamber.
- OK -- Check the other status screens to determine the condition causing the warning message.

2.3 Keeping System Calibrated



Depending on the circumstances of the application, periodically verify system calibration to maintain measurement accuracy.

Maintenance Tip! Upon startup, frequently check the system until operating experience can determine the optimum time between calibrations that provides acceptable measurement results.



Calibrate the system using an appropriate method. Refer to Part Three, Section 5 for details. **A common cause of measurement error is calibrating with an incorrectly prepared formazin suspension.**

NOTE: *When calibrating with a formazin suspension, carefully prepare the suspension using Class A laboratory glassware and correct analytical techniques. This is very essential to attain accurate measurement results.*

2.4 Avoiding Electrical Interference



Recommendation: Do not run the sensor cable (and interconnect cable, if used) in the same conduit with line power.

Maintenance Tip! Excess cable should not be coiled near motors or other equipment that may generate electrical or magnetic fields. Cut cables to proper length during installation to avoid unnecessary inductive pickup ("electrical noise" may interfere with sensor signal).

SECTION 3 TROUBLESHOOTING

3.1 System Diagnostic Condition Messages

When the system diagnostics detects an abnormal condition, the MEASURE screen flashes the "WARNING CHECK STATUS" message. To identify the condition causing the warning, display the "STATUS" screens in the TEST/MAINT menu branch (Part Three, Section 6.1). Pressing the **ENTER** key sequentially displays these status screens:

Table D – SYSTEM DIAGNOSTIC CONDITION STATUS SCREENS/MEANINGS	
Displayed STATUS Screen	Meaning
ANALYZER: OK.....	Analyzer is operating properly.
FAIL	Analyzer is not operating properly. Call Omega Engineering Customer Service Dept.
SENSOR: OK.....	Sensor is operating properly.
CHAMBER DIRTY.....	Clean the sensor flow chamber. See Part Four, Section 1.1.
CHAMBER UNKNOWN ...	Sensor is disconnected, incorrectly wired, or sources or detectors are not operating properly. Call Omega Engineering Customer Service Dept.
SOURCE 1 (or 2): OK.....	Light source is operating normally.
FAIL	Light source is disconnected, incorrectly wired, or not operating properly. Call Omega Engineering Customer Service Dept.
DETECT 1 (or 2): OK.....	Detector is operating normally.
FAIL	Detector is disconnected, incorrectly wired, or not operating properly. Call Omega Engineering Customer Service Dept.
RELAY (A, B, C, D) ACTIVE.....	Relay is energized. The measured value has reached the setpoint (control relay) or the low or high alarm point (alarm relay), or a system diagnostic condition exists (status relay).
INACTIVE.....	Relay is de-energized. The measured value has not reached the setpoint (control relay) or the low or high alarm point (alarm relay), or a system diagnostic condition has not been detected.
TIMEOUT	Relay is de-energized. The overfeed timer has timed out and must be manually reset (control relay only).
COUNTING	Relay is energized. The overfeed timer is counting down, but has not yet timed out (control relay only).

3.2 Isolating Measuring System Problem

Checking Electrical Connections

When experiencing problems, try to determine the primary measurement system component causing the problem (analyzer, sensor, or sensor cable).

1. Verify that line power exists at the appropriate analyzer TB3 terminals.
2. Check all analyzer and sensor cable connections to ensure that they are correctly wired and securely tightened.

Checking Operation Using System Diagnostics

Use the system diagnostics capability ("STATUS" screens in TEST/MAINT menu branch) to determine if the analyzer or sensor is inoperative.

Successfully calibrating the system usually confirms that the analyzer and sensor are operating properly. If the sensor cable is suspected, disconnect it at both ends (sensor and analyzer) and, using an ohmmeter, check its wires for continuity and internal shorts.

SECTION 4**ANALYZER REPAIR/RETURN****4.1 Customer Assistance**

If you need spare parts, assistance in troubleshooting, or repair service, please contact your local Omega Engineering representative, or the Omega Engineering Customer Service Department at:

Omega Engineering, Inc.. Phone: [800] 622-2378

4.2 Repair/Return Policy

All analyzers or sensors returned for repair or replacement must be freight prepaid and include the following information:

1. A clearly written description of the malfunction.
2. Name of person to contact and the phone number where they can be reached.
3. Proper return address for shipping analyzer(s) or sensor(s) back. Include preferred shipping method (UPS, Federal Express, etc.) if applicable.
4. A purchase order if analyzer(s) or sensor(s) is out of warranty to cover costs of repair.



NOTE: *If the analyzer or sensor is damaged during return shipment because of inadequate packaging, the customer is responsible for any resulting repair costs. (Recommendation: Use the original Omega Engineering shipping carton or an equivalent.)*

Also, Omega Engineering will not accept analyzers or sensors returned for repair or replacement unless they are thoroughly cleaned and all process material is removed.



WARRANTY/DISCLAIMER

OMEGA ENGINEERING, INC. warrants this unit to be free of defects in materials and workmanship for a period of **25 months** from date of purchase. OMEGA's WARRANTY adds an additional one (1) month grace period to the normal **two (2) year product warranty** to cover handling and shipping time. This ensures that OMEGA's customers receive maximum coverage on each product.

If the unit malfunctions, it must be returned to the factory for evaluation. OMEGA's Customer Service Department will issue an Authorized Return (AR) number immediately upon phone or written request. Upon examination by OMEGA, if the unit is found to be defective, it will be repaired or replaced at no charge. OMEGA's WARRANTY does not apply to defects resulting from any action of the purchaser, including but not limited to mishandling, improper interfacing, operation outside of design limits, improper repair, or unauthorized modification. This WARRANTY is VOID if the unit shows evidence of having been tampered with or shows evidence of having been damaged as a result of excessive corrosion; or current, heat, moisture or vibration; improper specification; misapplication; misuse or other operating conditions outside of OMEGA's control. Components which wear are not warranted, including but not limited to contact points, fuses, and triacs.

OMEGA is pleased to offer suggestions on the use of its various products. However, OMEGA neither assumes responsibility for any omissions or errors nor assumes liability for any damages that result from the use of its products in accordance with information provided by OMEGA, either verbal or written. OMEGA warrants only that the parts manufactured by it will be as specified and free of defects. OMEGA MAKES NO OTHER WARRANTIES OR REPRESENTATIONS OF ANY KIND WHATSOEVER, EXPRESS OR IMPLIED, EXCEPT THAT OF TITLE, AND ALL IMPLIED WARRANTIES INCLUDING ANY WARRANTY OF MERCHANTABILITY AND FITNESS FOR A PARTICULAR PURPOSE ARE HEREBY DISCLAIMED. LIMITATION OF LIABILITY: The remedies of purchaser set forth herein are exclusive, and the total liability of OMEGA with respect to this order, whether based on contract, warranty, negligence, indemnification, strict liability or otherwise, shall not exceed the purchase price of the component upon which liability is based. In no event shall OMEGA be liable for consequential, incidental or special damages.

CONDITIONS: Equipment sold by OMEGA is not intended to be used, nor shall it be used: (1) as a "Basic Component" under 10 CFR 21 (NRC), used in or with any nuclear installation or activity; or (2) in medical applications or used on humans. Should any Product(s) be used in or with any nuclear installation or activity, medical application, used on humans, or misused in any way, OMEGA assumes no responsibility as set forth in our basic WARRANTY/DISCLAIMER language, and, additionally, purchaser will indemnify OMEGA and hold OMEGA harmless from any liability or damage whatsoever arising out of the use of the Product(s) in such a manner.

RETURN REQUESTS/INQUIRIES

Direct all warranty and repair requests/inquiries to the OMEGA Customer Service Department. **BEFORE RETURNING ANY PRODUCT(S) TO OMEGA, PURCHASER MUST OBTAIN AN AUTHORIZED RETURN (AR) NUMBER FROM OMEGA'S CUSTOMER SERVICE DEPARTMENT (IN ORDER TO AVOID PROCESSING DELAYS).** The assigned AR number should then be marked on the outside of the return package and on any correspondence.

The purchaser is responsible for shipping charges, freight, insurance and proper packaging to prevent breakage in transit.

FOR **WARRANTY** RETURNS, please have the following information available **BEFORE** contacting OMEGA:

1. Purchase Order number under which the product was **PURCHASED**,
2. Model and serial number of the product under warranty, and
3. Repair instructions and/or specific problems relative to the product.

FOR **NON-WARRANTY** REPAIRS, consult OMEGA for current repair charges. Have the following information available **BEFORE** contacting OMEGA:

1. Purchase Order number to cover the **COST** of the repair,
2. Model and serial number of the product, and
3. Repair instructions and/or specific problems relative to the product.

OMEGA's policy is to make running changes, not model changes, whenever an improvement is possible. This affords our customers the latest in technology and engineering.

OMEGA is a registered trademark of OMEGA ENGINEERING, INC.

© Copyright 2003 OMEGA ENGINEERING, INC. All rights reserved. This document may not be copied, photocopied, reproduced, translated, or reduced to any electronic medium or machine-readable form, in whole or in part, without the prior written consent of OMEGA ENGINEERING, INC.

Where Do I Find Everything I Need for Process Measurement and Control?

OMEGA...Of Course!

Shop online at www.omega.com

TEMPERATURE

- Thermocouple, RTD & Thermistor Probes, Connectors, Panels & Assemblies
- Wire: Thermocouple, RTD & Thermistor
- Calibrators & Ice Point References
- Recorders, Controllers & Process Monitors
- Infrared Pyrometers

PRESSURE, STRAIN AND FORCE

- Transducers & Strain Gages
- Load Cells & Pressure Gages
- Displacement Transducers
- Instrumentation & Accessories

FLOW/LEVEL

- Rotameters, Gas Mass Flowmeters & Flow Computers
- Air Velocity Indicators
- Turbine/Paddlewheel Systems
- Totalizers & Batch Controllers

pH/CONDUCTIVITY

- pH Electrodes, Testers & Accessories
- Benchtop/Laboratory Meters
- Controllers, Calibrators, Simulators & Pumps
- Industrial pH & Conductivity Equipment

DATA ACQUISITION

- Data Acquisition & Engineering Software
- Communications-Based Acquisition Systems
- Plug-in Cards for Apple, IBM & Compatibles
- Datalogging Systems
- Recorders, Printers & Plotters

HEATERS

- Heating Cable
- Cartridge & Strip Heaters
- Immersion & Band Heaters
- Flexible Heaters
- Laboratory Heaters

ENVIRONMENTAL MONITORING AND CONTROL

- Metering & Control Instrumentation
- Refractometers
- Pumps & Tubing
- Air, Soil & Water Monitors
- Industrial Water & Wastewater Treatment
- pH, Conductivity & Dissolved Oxygen Instruments