

Ω OMEGA ENGINEERING, INC.

PX673/675 Series

Flush Diaphragm Pressure Transducer



INSTRUCTION SHEET

M3423/0699

INSTALLATION INSTRUCTIONS FOR OMEGA® FLUSH DIAPHRAGM PRESSURE TRANSDUCER

Mounting

Although the unit can withstand normal vibration without damage or significant output effects, it is always good practice to mount the transducer where there is minimum vibration.

Power Supply

The supply voltage for the 1-5 and 1-6 Vdc output transducers must be within the range of 10 to 36 Vdc. The maximum supply voltage for a 4-20mA current output transducer is 36 Vdc while the minimum supply voltage is dependent upon the loop resistance of the circuit. The figure below shows the minimum supply voltage (V_{min}) required for a given loop resistance (R_{LOOP}).

Noise

For minimum noise susceptibility, avoid running the transducer's cable in a conduit that contains high current ac power cables. Where possible avoid running the cable near inductive equipment.

Shield Wiring

Connect the braided shield to the guard terminal on the reading instrument (meter, etc.) if available or to ground or to the power supply negative terminal.

Adjustment Potentiometers

The zero and span pots are accessible through the top of the case. Loosen the collar and separate the top carefully. The zero pot is marked with a white dot.

Vent Tube

The cable will have a clear Teflon vent tube that's required at pressure below 500 psi to provide atmospheric reference. The open end should be placed in a dry area.

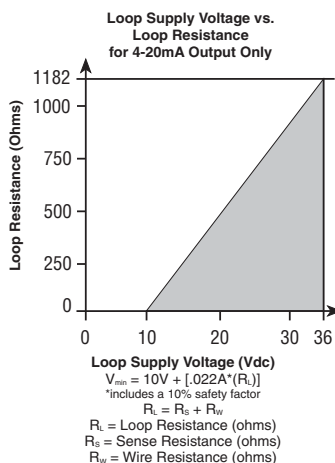

WARNING!

This instrument is susceptible to damage when exposed to static electrical charges. To avoid damage to the transducer observe the following:

- Ground the body of the transducer BEFORE making any electrical connections
- When disconnecting, remove the ground LAST.

NOTE: The braided shield and drain wire in the cable (if supplied) is not connected to the transducer body, and is not a suitable ground.

CAUTION: Pressure spikes in excess of the rated overpressure capability of the transducer may cause irreversible electrical and/or mechanical damage to the pressure measuring and containing element(s).

WARNING: READ BEFORE INSTALLATION

The diaphragm is very sensitive and fragile! Do not let anything touch the diaphragm but the fluid to be measured. Fluid hammer and surges can destroy any pressure transducer and must always be avoided. A pressure snubber should be installed to eliminate the damaging hammer effects. Fluid hammer occurs when a liquid flow is suddenly stopped, as with quick-closing solenoid valves. Surges occur when flow is suddenly begun, as when a pump is turned on at full power or a valve is quickly opened.

Liquid surges are particularly damaging to pressure transducers if the pipe is originally empty. To avoid damaging surges, fluid lines should remain full (if possible),

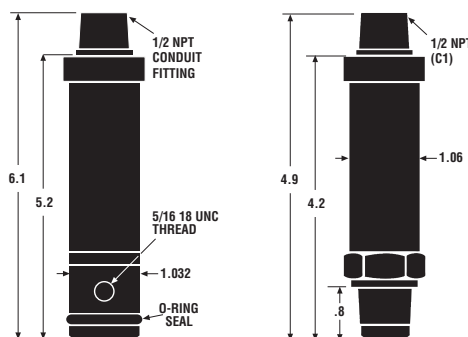

pumps should be brought up to power slowly, and valves opened slowly. To avoid damage from both fluid hammer and surges, a surge chamber should be installed.

Symptoms of fluid hammer and surge's damaging effects:

- a) Pressure transducer exhibits an output at zero pressure (large zero offset). If zero offset is less than 10% FS, user can usually re-zero transducer, install proper snubber and continue monitoring pressures.
- b) Pressure transducer output remains constant regardless of pressure.
- c) In severe cases, there will be no output.

Electrical Connections

Voltage Output Units 1-5, 1-6 Vdc

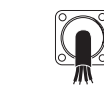

Cable Type C1

Red = + Power
 Black = Common
 White = Output

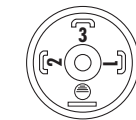

DIN Type

PIN-1 = + Power
 PIN-2 = Common
 PIN-3 = Output

Current Output Units 4-20mA

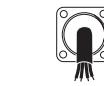

Cable Type C1

Red = +Power
 Black = -Power

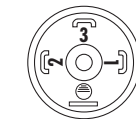

DIN Type

PIN-1 = + Power
 PIN-2 = -Power

Wiring Diagrams for All Transducers

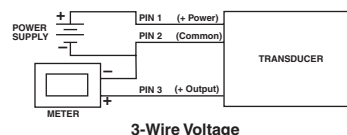
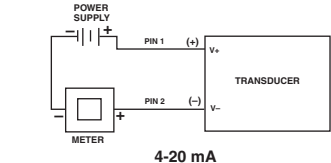

Recalibration Instructions:

1. Apply 0% Full Scale Pressure.
2. Set the output using the Zero adjustment potentiometer.
3. Apply 100% Full Scale Pressure.
4. Set the output using the Span adjustment potentiometer.
5. Repeat steps 1 thru 4 as necessary.



OMEGAnet® On-Line Service
www.omega.com

Internet e-mail
info@omega.com

Servicing North America:

USA:
ISO 9001 Certified

One Omega Drive, P.O. Box 4047
Stamford CT 06907-0047
TEL: (203) 359-1660 FAX: (203) 359-7700
e-mail: info@omega.com

Canada:

976 Bergar
Laval (Quebec) H7L 5A1
TEL: (514) 856-6928 FAX: (514) 856-6886
e-mail: canada@omega.com

For immediate technical or application assistance:

USA and Canada: Sales Service: 1-800-826-6342 / 1-800-TC-OMEGA®
Customer Service: 1-800-622-2378 / 1-800-622-BEST®
Engineering Service: 1-800-872-9436 / 1-800-USA-WHEN®
TELEX: 996404 EASYLINK: 62968934 CABLE: OMEGA

Mexico:

Tel: (001) 800-826-6342 FAX: (001) 203-359-7807
En Español: (001) 203-359-7803 e-mail: espanol@omega.com
info@omega.com.mx

Servicing Europe:

Benelux:

Postbus 8034, 1180 LA Amstelveen, The Netherlands
Tel: +31 (0)20 6418405 FAX: +31 (0)20 6434643
Toll Free in Benelux: 06 0993344
e-mail: nl@omega.com

Czech Republic:

Rudé armády 1868,73301 Karviná
TEL: +420 (0)69 6311899 FAX: +420 (0)69 6311114
Toll Free in Czech Rep.: 0800-1-66342
e-mail: czech@omega.com

France:

9, rue Denis Papin, 78190 Trappes
TEL: +33 (0)130 621 400 FAX: +33 (0)130 699 120
Toll Free in France: 0800-4-06342
e-mail: france@omega.com

Germany/Austria:

Daimlerstrasse 26, D-75392 Deckenpfronn, Germany
TEL: +49 (0)7056 3017 FAX: +49 (0)7056 8540
Toll Free in Germany: 0800 TC OMEGASM
e-mail: germany@omega.com

United Kingdom:

ISO 9002 Certified
P.O. Box 7, Omega Drive,
Irlam, Manchester,
M44 5EX, United Kingdom
TEL: +44 (0)161 777 6611 FAX: +44 (0)161 777 6622
Toll Free in England: 0800 488 488
e-mail: sales@omega.co.uk

It is the policy of OMEGA to comply with all worldwide safety and EMC/EMI regulations that apply. OMEGA is constantly pursuing certification of its products to the European New Approach Directives. OMEGA will add the CE mark to every appropriate device upon certification.

The information contained in this document is believed to be correct but OMEGA Engineering, Inc. accepts no liability for any errors it contains, and reserves the right to alter specifications without notice.

WARNING: These products are not designed for use in, and should not be used for, patient connected applications.

MADE IN

USA

WARRANTY/DISCLAIMER

OMEGA ENGINEERING, INC. warrants this unit to be free of defects in materials and workmanship for a period of **13 months** from date of purchase. OMEGA's Warranty adds an additional one (1) month grace period to the normal **one (1) year product warranty** to cover handling and shipping time. This ensures that OMEGA's customers receive maximum coverage on each product.

If the unit should malfunction, it must be returned to the factory for evaluation. OMEGA's Customer Service Department will issue an Authorized Return (AR) number immediately upon phone or written request. Upon examination by OMEGA, if the unit is found to be defective it will be repaired or replaced at no charge. OMEGA's WARRANTY does not apply to defects resulting from any action of the purchaser, including but not limited to mishandling, improper interfacing, operation outside of design limits, improper repair, or unauthorized modification. This WARRANTY is VOID if the unit shows evidence of having been tampered with or shows evidence of being damaged as a result of excessive corrosion; or current, heat, moisture or vibration; improper specification; misapplication; misuse or other operating conditions outside of OMEGA's control. Components which wear are not warranted, including but not limited to contact points, fuses, and triacs.

OMEGA is pleased to offer suggestions on the use of its various products. However, OMEGA neither assumes responsibility for any omissions or errors nor assumes liability for any damages that result from the use of its products in accordance with information provided by OMEGA, either verbal or written. OMEGA warrants only that the parts manufactured by it will be as specified and free of defects. OMEGA MAKES NO OTHER WARRANTIES OR REPRESENTATIONS OF ANY KIND WHATSOEVER, EXPRESSED OR IMPLIED, EXCEPT THAT OF TITLE, AND ALL IMPLIED WARRANTIES INCLUDING ANY WARRANTY OF MERCHANTABILITY AND FITNESS FOR A PARTICULAR PURPOSE ARE HEREBY DISCLAIMED. LIMITATION OF LIABILITY: The remedies of purchaser set forth herein are exclusive and the total liability of OMEGA with respect to this order, whether based on contract, warranty, negligence, indemnification, strict liability or otherwise, shall not exceed the purchase price of the component upon which liability is based. In no event shall OMEGA be liable for consequential, incidental or special damages.

CONDITIONS: Equipment sold by OMEGA is not intended to be used, nor shall it be used: (1) as a "Basic Component" under 10 CFR 21 (NRC), used in or with any nuclear installation or activity; or (2) in medical applications or used on humans. Should any Product(s) be used in or with any nuclear installation or activity, medical application, used on humans, or misused in any way, OMEGA assumes no responsibility as set forth in our basic WARRANTY/DISCLAIMER language, and additionally, purchaser will indemnify OMEGA and hold OMEGA harmless from any liability or damage whatsoever arising out of the use of the Product(s) in such a manner.

RETURN REQUESTS / INQUIRIES

Direct all warranty and repair requests/inquiries to the OMEGA Customer Service Department. BEFORE RETURNING ANY PRODUCT(S) TO OMEGA, PURCHASER MUST OBTAIN AN AUTHORIZED RETURN (AR) NUMBER FROM OMEGA'S CUSTOMER SERVICE DEPARTMENT (IN ORDER TO AVOID PROCESSING DELAYS). The assigned AR number should then be marked on the outside of the return package and on any correspondence.

The purchaser is responsible for shipping charges, freight, insurance and proper packaging to prevent breakage in transit.

FOR **WARRANTY** RETURNS, please have the following information available BEFORE contacting OMEGA:

1. P.O. number under which the product was PURCHASED,
2. Model and serial number of the product under warranty, and
3. Repair instructions and/or specific problems relative to the product.

FOR **NON-WARRANTY** REPAIRS, consult OMEGA for current repair charges. Have the following information available BEFORE contacting OMEGA:

1. P.O. number to cover the COST of the repair,
2. Model and serial number of product, and
3. Repair instructions and/or specific problems relative to the product.

OMEGA's policy is to make running changes, not model changes, whenever an improvement is possible. This affords our customers the latest in technology and engineering.

OMEGA is a registered trademark of OMEGA ENGINEERING, INC.

© Copyright 1999 OMEGA ENGINEERING, INC. All rights reserved. This document may not be copied, photocopied, reproduced, translated, or reduced to any electronic medium or machine-readable form, in whole or in part, without prior written consent of OMEGA ENGINEERING, INC.