



User's Guide



Shop online at

omega.com®

Ω OMEGA®

www.omega.com

e-mail: info@omega.com

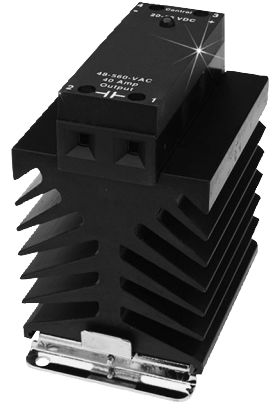

**SSRDC100V, SSR330, SSR660,
SSRINT660, SSR3PH660,
SSRDIN660 Series
Solid State Relays**



OMEGAnet® Online Service www.omega.com	Internet e-mail info@omega.com
---	---

Servicing North America:

USA: One Omega Drive, Box 4047
ISO 9001 Certified Stamford CT 06907-0047
Tel: (203) 359-1660 FAX: (203) 359-7700
e-mail: info@omega.com

Canada: 976 Bergar
Laval (Quebec) H7L 5A1
Tel: (514) 856-6928 FAX: (514) 856-6886
e-mail: info@omega.ca

For immediate technical or application assistance:

USA and Canada: Sales Service: 1-800-826-6342 / 1-800-TC-OMEGA®
Customer Service: 1-800-622-2378 / 1-800-622-BEST®
Engineering Service: 1-800-872-9436 / 1-800-USA-WHEN®
TELEX: 996404 EASYLINK: 62968934 CABLE: OMEGA

Mexico: En Español: (001) 203-359-7803 e-mail: espanol@omega.com
FAX: (001) 203-359-7807 info@omega.com.mx

Servicing Europe:

Benelux: Postbus 8034, 1180 LA Amstelveen, The Netherlands
Tel: +31 (0)20 3472121 FAX: +31 (0)20 6434643
Toll Free in Benelux: 0800 0993344
e-mail: sales@omegaeng.nl

Czech Republic: Rude' armády 1868, 733 01 Karviná 8
Tel: +420 (0)69 6311899 FAX: +420 (0)69 6311114
Toll Free: 0800-1-66342 e-mail: czech@omega.com

France: 9, rue Denis Papin, 78190 Trappes
Tel: +33 (0)130 621 400 FAX: +33 (0)130 699 120
Toll Free in France: 0800-4-06342
e-mail: sales@omega.fr

Germany/Austria: Daimlerstrasse 26, D-75392 Deckenpfronn, Germany
Tel: +49 (0)7056 9398-0 FAX: +49 (0)7056 9398-29
Toll Free in Germany: 0800 639 7678
e-mail: info@omega.dl

United Kingdom: One Omega Drive, River Bend Technology Centre
ISO 9002 Certified Northbank, Irlam, Manchester
M44 5BD United Kingdom
Tel: +44 (0)161 777 6611 FAX: +44 (0)161 777 6622
Toll Free in United Kingdom: 0800-488-488
e-mail: sales@omega.co.uk

It is the policy of OMEGA to comply with all worldwide safety and EMC/EMI regulations that apply. OMEGA is constantly pursuing certification of its products to the European New Approach Directives. OMEGA will add the CE mark to every appropriate device upon certification.
The information contained in this document is believed to be correct, but OMEGA Engineering, Inc. accepts no liability for any errors it contains, and reserves the right to alter specifications without notice.
WARNING: These products are not designed for use in, and should not be used for, patient-connected applications.

PRECAUTIONS

A number of essential safety precautions must be observed in the installation and use of a Solid State Relay (SSR).

The SSR's should be installed and serviced by qualified technicians familiar with high voltage and current circuits. Note that an SSR has a small leakage current when the contacts are "open". Normal failure condition is contacts "closed". A special Fast Blowing I^T fuse and a mechanical interrupt switch are recommended in the load circuit. In certain applications a mechanical interrupt switch should be installed in the control circuit.

GENERAL DESCRIPTION

The OMEGA® Solid State Relays (SSR's) are a series of normally open, solid state switching devices with no moving parts, capable of tens of millions of cycles of operation. They are designed to control 120V, 240V, 440V, or 660V alternating current (VAC), and provide zero voltage switching and 4000VAC isolation between the load terminals and the control signal. A control signal causes the SSR to switch the AC load ON or OFF just as a conventional mechanical contact switch does but without the problems associated with moving contact relays, such as corrosion, pitting, arcing radio frequency interference (RFI) and bounce.

FINNED HEAT SINKS (FHS)

To dissipate the heat developed naturally in an SSR due to a nominal voltage drop across the device, the panel mount SSR's must be mounted on a Finned Heat Sink (FHS), or on a metal plate of adequate size (see Derating Curves on page 8). The Finned Heat Sinks (FHS) are anodized, aluminum fabrications which come complete with tapped mounting holes. Use with thermally conductive compound (Omega part number OT-201) for panel mount SSR's. The DIN rail mount SSR's come with integrated heatsinks. It is advisable to install an SSR where the ambient temperature is relatively low because its current-switching rating is decreased as its temperature increases. For SSR's with integral heatsinks leave at least 1 inch (25mm) of space between relays and space above and below each heatsink equivalent to the height of the unit.

FUSE PROTECTION

The load side of the SSR' should be protected by a Semiconductor I^T fuse. Although a semiconductor relay is designed for virtually countless operation cycles, it can be destroyed by an over-voltage or a short circuit, unless protected adequately by a fast fuse.

Bussman or equivalent fuses should be used. Select a fuse with a current and voltage rating less than the maximum rating of the relay. It is essential that a proper semiconductor (I^T) fuse is used. SSR's normal failure mode on overloaded circuits is closed contacts (ON-STATE).

LEAKAGE CURRENT

In the OFF state, all SSR's have a small leakage current through their contacts, typically 5 to 15 milliamperes (mA). As a result, a voltage potential will always exist on the LOAD SIDE, even where the "contacts" are "open." The voltage level is a function of the load resistance. In accordance with $E = IR$, the voltage level equals leakage current times load resistance.

The voltage level will rise to FULL LINE VOLTAGE under NO LOAD (open circuit) or high resistance condition. Under normal operating conditions, however, it is very small. A 120-watt (W) load has a resistance of 1 ohm. With "open contacts," a leakage current of 15mA will cause 15mV across the load ($E = 15 \text{ mA} \times 1 \text{ ohm}$).

AC Output Single Phase Relays

DC Control Specifications

Model Number	Line Voltage Range (Vac)	Load Current Range (Arms)	Min Control Voltage & Current Draw	Max Control Voltage & Current Draw	Release Voltage (VDC)	Schematics	Mechanical	Derating
SSR330DC10	24 to 330 Vac	0.05 to 10	4 Vdc/5.4 mA	32 Vdc/10 mA	1 Vdc	1	D	1
SSR330DC25	24 to 330 Vac	0.10 to 25	4 Vdc/5.4 mA	32 Vdc/10 mA	1 Vdc	1	D	1
SSR330DC50	24 to 330 Vac	0.10 to 50	4Vdc/3.5 mA	32 Vdc/8.0 mA	1 Vdc	1	D	2
SSR330DC75	24 to 330 Vac	0.10 to 75	4Vdc/3.5 mA	32 Vdc/8.0 mA	1 Vdc	1	D	2
SSR660DC50	24 to 660 Vac	0.10 to 50	4Vdc/3.5 mA	32 Vdc/8.0 mA	1 Vdc	1	D	2
SSR660DC75	24 to 660 Vac	0.10 to 75	4Vdc/3.5 mA	32 Vdc/8.0 mA	1 Vdc	1	D	2

AC Control Specifications

Model Number	Line Voltage Range (Vac)	Load Current Range (Arms)	Min Control Voltage & Current Draw	Max Control Voltage & Current Draw	Release Voltage (VAC)	Schematics	Mechanical	Derating
SSR330AC10	24 to 330 Vac	0.05 to 10	100 Vac/2.0 mA	280 Vac/19 mA	20 Vac	3	D	1
SSR330AC25	24 to 330 Vac	0.10 to 25	100 Vac/2.0 mA	280 Vac/19 mA	20 Vac	3	D	1
SSR330AC50	24 to 330 Vac	0.10 to 50	100 Vac/2.0 mA	280 Vac/19 mA	20 Vac	3	D	2
SSR330AC75	24 to 330 Vac	0.10 to 75	100 Vac/2.0 mA	280 Vac/19 mA	20 Vac	3	D	2
SSR660AC50	24 to 660 Vac	0.10 to 50	100 Vac/2.0 mA	280 Vac/19 mA	20 Vac	3	D	2
SSR660AC75	24 to 660 Vac	0.10 to 75	100 Vac/2.0 mA	280 Vac/19 mA	20 Vac	3	D	2

DC Control Specifications

Model Number	Line Voltage Range (Vac)	Load Current Range (Arms)	Min Control Voltage & Current Draw	Max Control Voltage & Current Draw	Release Voltage (VDC)	Schematics	Mechanical	Derating
SSRDIN660DC25	24 to 660 Vac	0.10 to 25	4 Vdc/3.5 mA	32 Vdc/8 mA	1 Vdc	2	F	3
SSRDIN660DC40	24 to 660 Vac	0.10 to 40	4 Vdc/3.5 mA	32 Vdc/8 mA	1 Vdc	2	G	3

AC Control Specifications

Model Number	Line Voltage Range (Vac)	Load Current Range (Arms)	Min Control Voltage & Current Draw	Max Control Voltage & Current Draw	Release Voltage (VAC)	Schematics	Mechanical	Derating
SSRDIN660AC25	24 to 660 Vac	0.10 to 25	100 Vac/9 mA	280 Vac/25 mA	20 Vac	4	F	3
SSRDIN660AC40	24 to 660 Vac	0.10 to 40	100 Vac/9 mA	280 Vac/25 mA	20 Vac	4	G	3

DC Control Specifications

Model Number	Line Voltage Range (Vac)	Load Current Range (Arms)	Min Control Voltage & Current Draw	Max Control Voltage & Current Draw	Release Voltage (VDC)	Schematics	Mechanical	Derating
SSRINT660DC50	48 to 660 Vac	0.10 to 50	4 Vdc/6 mA	28 Vdc/9 mA	1 Vdc	5	A	4
SSRINT660DC75	48 to 660 Vac	0.10 to 75	4 Vdc/6 mA	28 Vdc/9 mA	1 Vdc	5	B	4
SSRINT660DC100	48 to 660 Vac	0.10 to 100	4 Vdc/6 mA	28 Vdc/9 mA	1 Vdc	5	C	4

AC Control Specifications

Model Number	Line Voltage Range (Vac)	Load Current Range (Arms)	Min Control Voltage & Current Draw	Max Control Voltage & Current Draw	Release Voltage (VAC)	Schematics	Mechanical	Derating
SSRINT660AC50	48 to 660 Vac	0.10 to 50	100 Vac/5 mA	280 Vac/15 mA	20 Vac	5	A	4
SSRINT660AC75	48 to 660 Vac	0.10 to 75	100 Vac/5 mA	280 Vac/15 mA	20 Vac	5	B	4
SSRINT660AC100	48 to 660 Vac	0.10 to 100	100 Vac/5 mA	280 Vac/15 mA	20 Vac	5	C	4

AC Output Three Phase Relays

DC Control Specifications

Model Number	Line Voltage Range (Vac)	Load Current Range (Arms)	Min Control Voltage & Current Draw	Max Control Voltage & Current Draw	Release Voltage (VDC)	Schematics	Mechanical	Derating
SSR3PH660DC30	48 to 660 Vdc	0.10 to 30	4 Vdc/10 mA	32 Vdc/18 mA	1 Vdc	6	F	7

AC Control Specifications

Model Number	Line Voltage Range (Vac)	Load Current Range (Arms)	Min Control Voltage & Current Draw	Max Control Voltage & Current Draw	Release Voltage (VAC)	Schematics	Mechanical	Derating
SSR3PH660AC30	48 to 660 Vac	0.10 to 30	100 Vac/10 mA	280 Vac/33 mA	20 Vac	6	F	7

DC Output / DC Control Relays

DC Control Specifications

Model Number	Line Voltage Range (Vac)	Load Current Range (A DC)	Min Control Voltage & Current Draw	Max Control Voltage & Current Draw	Release Voltage (VDC)	Schematics	Mechanical	Derating
SSRDC100VDC8	0-100 Vdc	8	4 Vdc/11 mA	28 Vdc/16 mA	1 Vdc	7	D	5
SSRDC100VDC12	0-100 Vdc	12	4 Vdc/11 mA	28 Vdc/16 mA	1 Vdc	7	D	5
SSRDC100VDC20	0-100 Vdc	20	4 Vdc/11 mA	28 Vdc/16 mA	1 Vdc	7	D	6
SSRDC100VDC40	0-100 Vdc	40	4 Vdc/11 mA	28 Vdc/16 mA	1 Vdc	7	D	6

Accessories

Model Number	Description	Rating
KAX-10		10A
KAX-25		25A
KAX-30		30A
KAX-50	Semiconductor	50A
KAX-70	Fuses	75A
KAX-SEMI-50 *		63A
KAX-SEMI-100 *		100A

* Replacement fuses for built-in fuses on SSRINT-series

Model Number	Description	Rating
OT-201-1/2	Thermally	14 g (1/2 oz)
OT-201-2	Conductive	57 g (2 oz)
OT-201-16	Compound	544 g (1 lb)

Model Number	Description	Rating	Mechanical
FHS-7	Finned	1.0 C/W	H
FHS-8	Heat Sink	1.5 C/W	I

Model Number	Description	Rating	Compatible Fuses
FB-1	Fuse Blocks	1	KAX-10, -25, & 30
FB-2	for External	2	KAX-10, -25, & 30
FB-3	Fuses	3	KAX-10, -25, & 30
BS-101		1	KAX-50, KAX-100

How to Use Tables

Product specifications are listed after each model number. After these product specs, codes for schematics, mechanical drawings and derating curves are listed. Schematics can be found on pages 4 and 5, Mechanical drawings on pages 5,6 and 7 and Derating curves are listed on page 8.

Example: SSR330DC10 - Refer to Schematic 1 on page 4, Mechanical drawing D on page 5 and Derating curve 1 on page 8.

Schematics

1

**SSR330DC
SSR660DC**

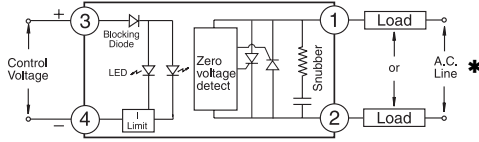

2

SSRDINDC

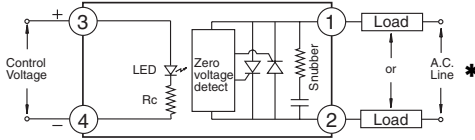

3

**SSR330AC
SSR660AC**

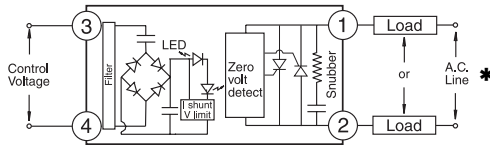

4

SSRDINAC

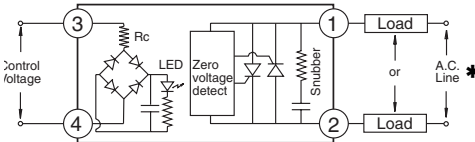

5

SSRINT660

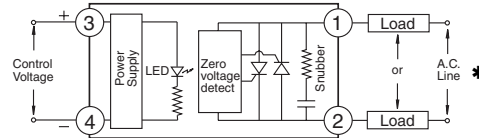

6

SSR3PH660

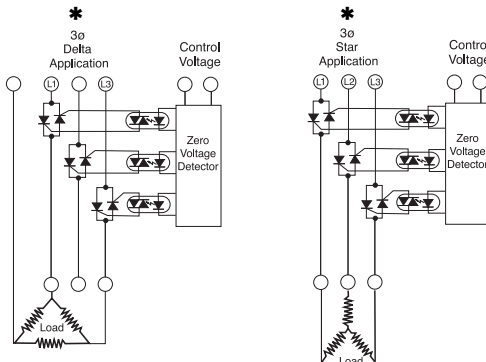

*Note: A fuse should be installed in series from the AC hot prior to connecting.

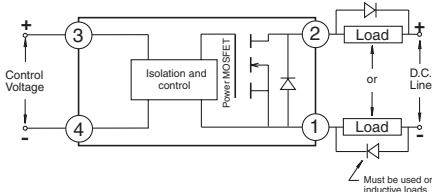

7

SSRDC

Note: A fuse should be installed in series prior to connecting, as shown above.

Mechanicals

Dimensions in Inches (mm)

A SSRINT Series-50 Amp

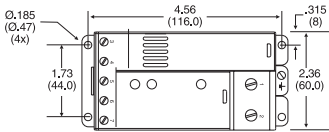

B SSRINT Series-75 Amp

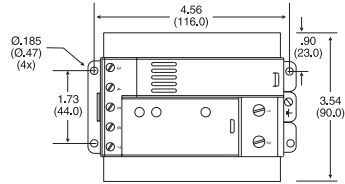

C SSRINT Series-100 Amp

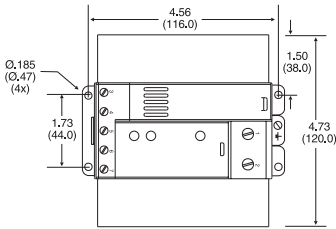

Sideview of A, B, C 50/75/100A SSRINT Series

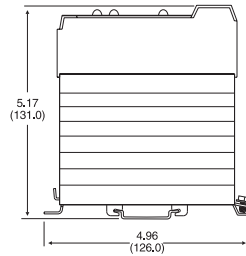

D SSR

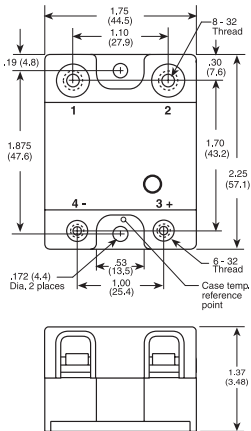

E SSR3PH Series-30 Amp

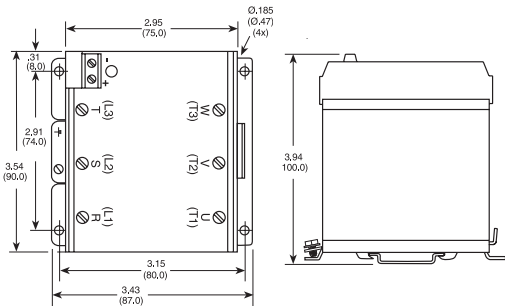

Mechanicals

Dimensions in Inches (mm)

F SSRDIN Series-25 Amp

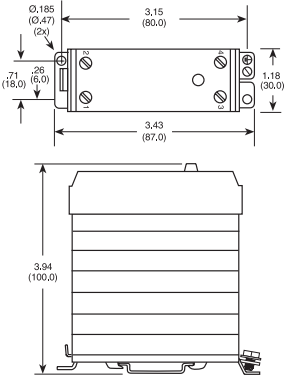

G SSRDIN Series-40 Amp

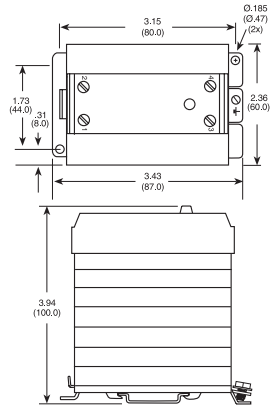

H FHS-7 Finned Heat Sink

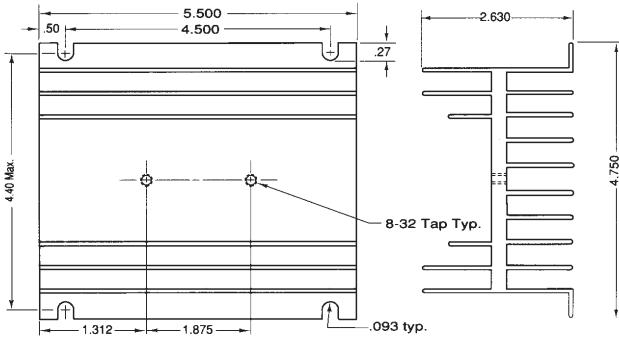

I FHS-8 Finned Heat Sink

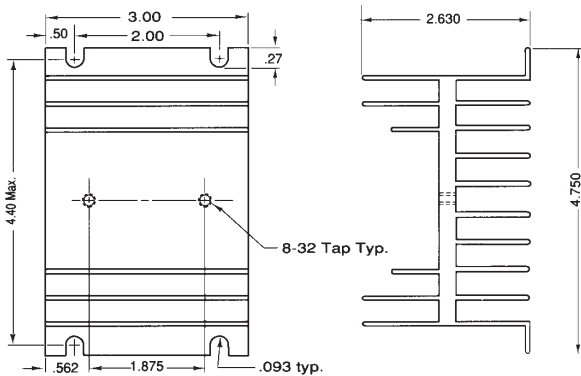

Wiring Examples

Typical Wiring

ac Controlled SSR used with Temperature Controller with dc Voltage SSR Driver Output

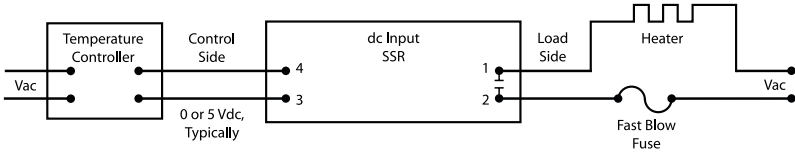

ac Controlled SSR used with Temperature Controller with Mechanical Relay Output

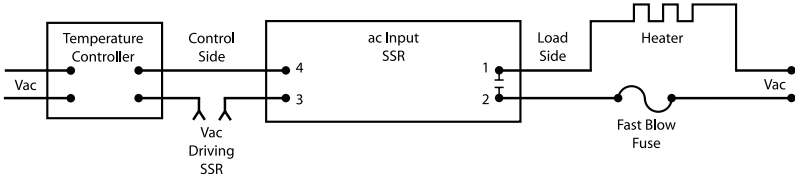

ac Controlled SSR used with Temperature Controller with Triac Output

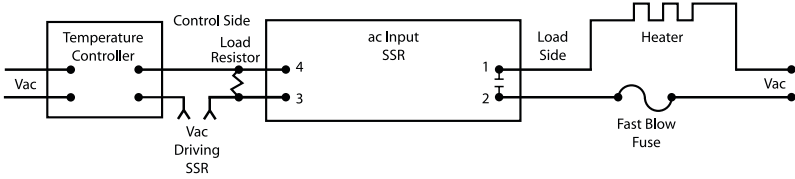

Derating Curves

Show maximum steady state current for given temperatures and relays.
 Current switching rating decreases as temperature increases.
 Free Air = SSR without any heatsink.

1 SSR 10 & 25 Amp (330 VAC)

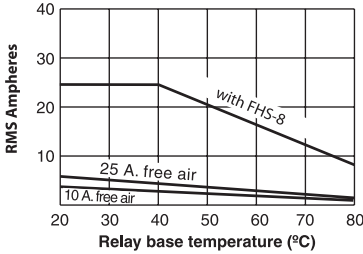

2 SSR 50 & 75 Amp (330 VAC)

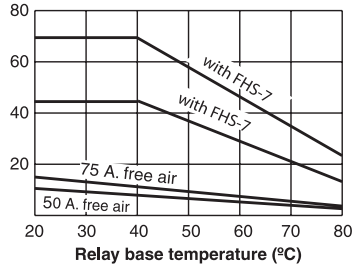

3 SSRDIN 25 & 40 Amp

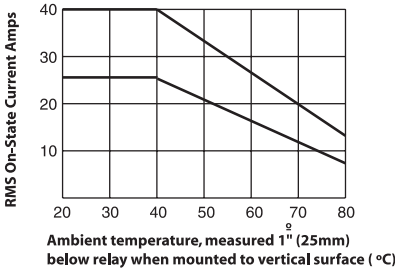

4 SSRINT 50, 75, 100 Amp (660 VAC)

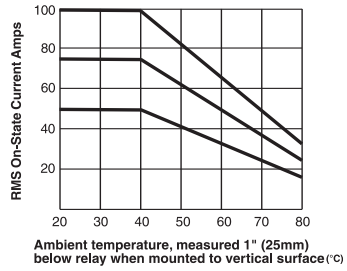

5 SSRDC 8 & 12 Amp (100 VDC)

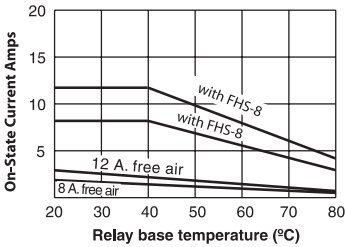

6 SSRDC 20 & 40 Amp (100 VDC)

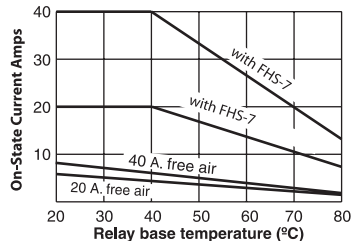

7 SSR3PH - 30 Amp 3 Phase

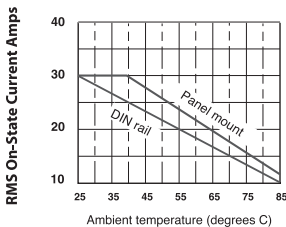

Ambient temperature (degrees C), measured 1 inch (25mm) below relay when mounted to DIN rail or a vertical, 1/8th inch thick aluminum panel surface. Airflow is unrestricted up and through the heatsink.

WARRANTY/DISCLAIMER

OMEGA ENGINEERING, INC. warrants this unit to be free of defects in materials and workmanship for a period of **13 months** from date of purchase. OMEGA's Warranty adds an additional one (1) month grace period to the normal **one (1) year product warranty** to cover handling and shipping time. This ensures that OMEGA's customers receive maximum coverage on each product.

If the unit malfunctions, it must be returned to the factory for evaluation. OMEGA's Customer Service Department will issue an Authorized Return (AR) number immediately upon phone or written request. Upon examination by OMEGA, if the unit is found to be defective, it will be repaired or replaced at no charge. OMEGA's WARRANTY does not apply to defects resulting from any action of the purchaser, including but not limited to mishandling, improper interfacing, operation outside of design limits, improper repair, or unauthorized modification. This WARRANTY is VOID if the unit shows evidence of having been tampered with or shows evidence of having been damaged as a result of excessive corrosion; or current, heat, moisture or vibration; improper specification; misapplication; misuse or other operating conditions outside of OMEGA's control. Components which wear are not warranted, including but not limited to contact points, fuses, and triacs.

OMEGA is pleased to offer suggestions on the use of its various products. However, OMEGA neither assumes responsibility for any omissions or errors nor assumes liability for any damages that result from the use of its products in accordance with information provided by OMEGA, either verbal or written. OMEGA warrants only that the parts manufactured by it will be as specified and free of defects. OMEGA MAKES NO OTHER WARRANTIES OR REPRESENTATIONS OF ANY KIND WHATSOEVER, EXPRESS OR IMPLIED, EXCEPT THAT OF TITLE, AND ALL IMPLIED WARRANTIES INCLUDING ANY WARRANTY OF MERCHANTABILITY AND FITNESS FOR A PARTICULAR PURPOSE ARE HEREBY DISCLAIMED. LIMITATION OF LIABILITY: The remedies of purchaser set forth herein are exclusive, and the total liability of OMEGA with respect to this order, whether based on contract, warranty, negligence, indemnification, strict liability or otherwise, shall not exceed the purchase price of the component upon which liability is based. In no event shall OMEGA be liable for consequential, incidental or special damages.

CONDITIONS: Equipment sold by OMEGA is not intended to be used, nor shall it be used: (1) as a "Basic Component" under 10 CFR 21 (NRC), used in or with any nuclear installation or activity; or (2) in medical applications or used on humans. Should any Product(s) be used in or with any nuclear installation or activity, medical application, used on humans, or misused in any way, OMEGA assumes no responsibility as set forth in our basic WARRANTY/DISCLAIMER language, and, additionally, purchaser will indemnify OMEGA and hold OMEGA harmless from any liability or damage whatsoever arising out of the use of the Product(s) in such a manner.

RETURN REQUESTS/INQUIRIES

Direct all warranty and repair requests/inquiries to the OMEGA Customer Service Department. **BEFORE RETURNING ANY PRODUCT(S) TO OMEGA, PURCHASER MUST OBTAIN AN AUTHORIZED RETURN (AR) NUMBER FROM OMEGA'S CUSTOMER SERVICE DEPARTMENT (IN ORDER TO AVOID PROCESSING DELAYS).** The assigned AR number should then be marked on the outside of the return package and on any correspondence.

The purchaser is responsible for shipping charges, freight, insurance and proper packaging to prevent breakage in transit.

FOR **WARRANTY** RETURNS, please have the following information available BEFORE contacting OMEGA:

1. Purchase Order number under which the product was PURCHASED,
2. Model and serial number of the product under warranty, and
3. Repair instructions and/or specific problems relative to the product.

FOR **NON-WARRANTY** REPAIRS, consult OMEGA for current repair charges. Have the following information available BEFORE contacting OMEGA:

1. Purchase Order number to cover the COST of the repair,
2. Model and serial number of the product, and
3. Repair instructions and/or specific problems relative to the product.

OMEGA's policy is to make running changes, not model changes, whenever an improvement is possible. This affords our customers the latest in technology and engineering.

OMEGA is a registered trademark of OMEGA ENGINEERING, INC.

© Copyright 2002 OMEGA ENGINEERING, INC. All rights reserved. This document may not be copied, photocopied, reproduced, translated, or reduced to any electronic medium or machine-readable form, in whole or in part, without the prior written consent of OMEGA ENGINEERING, INC.

Where Do I Find Everything I Need for Process Measurement and Control? **OMEGA...Of Course!**

Shop online at www.omega.com

TEMPERATURE

- Thermocouple, RTD & Thermistor Probes, Connectors, Panels & Assemblies
- Wire: Thermocouple, RTD & Thermistor
- Calibrators & Ice Point References
- Recorders, Controllers & Process Monitors
- Infrared Pyrometers

PRESSURE, STRAIN AND FORCE

- Transducers & Strain Gages
- Load Cells & Pressure Gages
- Displacement Transducers
- Instrumentation & Accessories

FLOW/LEVEL

- Rotameters, Gas Mass Flowmeters & Flow Computers
- Air Velocity Indicators
- Turbine/Paddlewheel Systems
- Totalizers & Batch Controllers

pH/CONDUCTIVITY

- pH Electrodes, Testers & Accessories
- Benchtop/Laboratory Meters
- Controllers, Calibrators, Simulators & Pumps
- Industrial pH & Conductivity Equipment

DATA ACQUISITION

- Data Acquisition & Engineering Software
- Communications-Based Acquisition Systems
- Plug-in Cards for Apple, IBM & Compatibles
- Datalogging Systems
- Recorders, Printers & Plotters

HEATERS

- Heating Cable
- Cartridge & Strip Heaters
- Immersion & Band Heaters
- Flexible Heaters
- Laboratory Heaters

ENVIRONMENTAL MONITORING AND CONTROL

- Metering & Control Instrumentation
- Refractometers
- Pumps & Tubing
- Air, Soil & Water Monitors
- Industrial Water & Wastewater Treatment
- pH, Conductivity & Dissolved Oxygen Instruments