

User's Guide



An OMEGA Technologies Company

*<http://www.omega.com>
e-mail: info@omega.com*



OSP SERIES
Portable IR thermometers



OMEGAnetSM On-Line Service http://www.omega.com	Internet e-mail info@omega.com
---	--

Servicing North America:

USA: One Omega Drive, Box 4047
ISO 9001 Certified Stamford, CT 06907-0047
Tel: (203) 359-1660 FAX: (203) 359-7700
e-mail: info@omega.com

Canada: 976 Bergar
Laval (Quebec) H7L 5A1
Tel: (514) 856-6928 FAX: (514) 856-6886
e-mail: info@omega.ca

For immediate technical or application assistance:

USA and Canada: Sales Service: 1-800-826-6342 / 1-800-TC-OMEGASM
Customer Service: 1-800-622-2378 / 1-800-622-BESTSM
Engineering Service: 1-800-872-9436 / 1-800-USA-WHENSM
TELEX: 996404 EASYLINK: 62968934 CABLE: OMEGA

Mexico and Latin America: Tel: (95) 800-826-6342 FAX: (95) 203-359-7807
En Español: (95) 203-359-7803
e-mail: espanol@omega.com

Servicing Europe:

Benelux: Postbus 8034, 1180 LA Amstelveen, The Netherlands
Tel: (31) 20 6418405 FAX: (31) 20 6434643
Toll Free in Benelux: 0800 0993344
e-mail: nl@omega.com

Czech Republic: ul. Rude armady 1868, 733 01 Karvina-Hranice, Czech Republic
Tel: 420 (69) 6311899 FAX: 420 (69) 6311114
Toll free: 0800-1-66342
e-mail: czech@omega.com

France: 9, rue Denis Papin, 78190 Trappes
Tel: (33) 130-621-400 FAX: (33) 130-699-120
Toll Free in France: 0800-4-06342
e-mail: france@omega.com

Germany/Austria: Daimlerstrasse 26, D-75392 Deckenpfronn, Germany
Tel: 49 (07056) 3017 FAX: 49 (07056) 8540
Toll Free in Germany: 0130 11 21 66
e-mail: info@omega.de

United Kingdom: One Omega Drive, River Bend Technology Centre
ISO 9002 Certified Northbank, Irlam, Manchester
M44 5EX, England
Tel: 44 (161) 777-6611 FAX: 44 (161) 777-6622
Toll Free in United Kingdom: 0800-488-488
e-mail: info@omega.co.uk

It is the policy of OMEGA to comply with all worldwide safety and EMC/EMI regulations that apply. OMEGA is constantly pursuing certification of its products to the European New Approach Directives. OMEGA will add the CE mark to every appropriate device upon certification.

The information contained in this document is believed to be corrected but OMEGA Engineering Inc. accepts no liability for any errors it contains, and reserves the right to alter specifications without notice.

WARNING: These products are not designed for use in, and should not be used for, patient connected applications.

INTRODUCTORY NOTE

This user's guide contains operating instructions, as well as a description of the principles of operation, of the **OSP Series** portable IR thermometers.

This information covers all models of the instrument, including the basic equipment and its options and accessories.

This manual is a complete "USER GUIDE", providing step-by-step instructions to operate the instrument in each of its designed functions.

OMEGA has used care and effort in preparing this guide and believes the information in this publication to be accurate. **OMEGA** products are subjected to continuous improvement, in order to pursue the technological leadership; these improvements could require changes to the information of this guide.

OMEGA reserves the right to change such information without notice.

No part of this document may be stored in a retrieval system, or transmitted in any form, electronic or mechanical, without prior written permission of **OMEGA Engineering Inc.**

OSP portable IR thermometers use sophisticated analogic and digital technologies. Any maintenance operation must be carried out by qualified personnel ONLY. We recommend you contact our technicians for any support requirements.

When Ni-MH rechargeable batteries are ordered, the unit can be powered also by 115V \pm 10% 50/60Hz line supply using the special power supply module provided.

OSP is fully tested in conformity with the directive n°89/336/CEE Electromagnetic Compatibility. **OMEGA** shall not be liable in any event, for technical or publishing error or omissions, or for any incidental and consequential damages, in connection with, or arising out of the use of this guide.

IMPORTANT : BEFORE USING THE **OSP** FOR THE FIRST TIME, GO OVER THESE OPERATING INSTRUCTIONS CAREFULLY AND KEEP THEM AVAILABLE FOR FUTURE REFERENCE.

Danger and Certification Labels

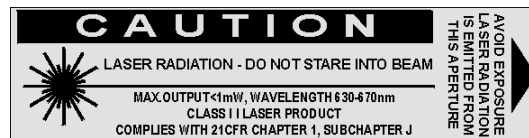
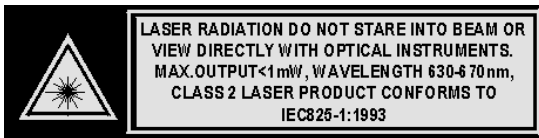

PATENT NOTICE: U.S. PAT. B1 5,368,392; 5,524,984; 5,727,880; 5,465,838; 5,823,678; 5,823,679. Other U.S. and Foreign Patents and Applications Pending. Manufactured in Italy. Licensed by Omega Engineering, Inc.

Labels Location – refer to section 8.2

Warnings and Cautions – refer to section 8.1

TABLE OF CONTENTS

1	GENERAL DESCRIPTION	6
1.1	Instrument codes	7
1.2	Specifications	8
2	GENERAL FEATURES	9
2.1	General.....	9
2.2	Optical System	9
2.3	Target pinpointing.....	9
2.4	Taking measurements	9
2.5	Keyboard	10
2.6	Display.....	10
2.7	Digital Interface.....	10
2.8	Self calibration.....	10
2.9	Thermocouple Input.....	10
2.10	Analog Output	10
2.11	Logging Mode.....	11
2.12	Calculated Measurements	11
2.13	Case	11
2.14	Logging Data Manager	11
3	PHYSICAL DESCRIPTION	12
4	FUNCTIONAL DESCRIPTION	13
4.1	Power supply	13
4.2	Keyboard	13
4.3	Microcontroller	14
4.4	Firmware	14
4.5	Display.....	14
4.6	Battery charger.....	14
4.7	Digital interface.....	14
5	UNPACKING	15
6	PRE-OPERATIONAL CHECK	16
7	POWER SUPPLY	17
7.1	Rechargeable batteries	17
7.1.1	How to maximize the life span of the battery	17
7.2	Power supply with alkaline batteries.....	17
7.3	Power supply from main line AC.....	17
8	WARNINGS & CAUTIONS	18
8.1	Laser Sight	18
8.2	Analogue input.....	18
8.3	Danger and Certification Labels	18
9	OPERATIONS	20
9.1	Quick Start.....	20
9.2	How to Operate the instrument.....	20
9.3	Hold	21
9.4	Laser sighting	21
9.5	Unstable temperature measurement	22
9.6	Alarm settings.....	23
9.7	Thermocouple input.....	24
9.8	Minimum, maximum, average and difference indication	25
9.9	Automatic Emissivity Setting	26
10	CONFIGURATION	27
10.1	Technical Unit selection.....	27
10.2	Thermocouple input enabled	27
10.3	Temperature Scale selection	27
10.4	Date & Real Time clock setting	28
10.5	Acquisition settings.....	28
10.6	Buzzer On/Off.....	29
10.7	OSP 500/800 decimal point selection.....	29
10.8	Ambient Temperature Compensation (TAM)	29
10.9	Firmware revision number	30
10.10	Instrument serial number	30
10.11	Battery level of charge	31

11	DATA ACQUISITION OPERATIVE MODE.....	32
11.1	How to operate in data acquisition mode.....	32
11.2	Recall stored data.....	34
12	LOGGING DATA MANAGER	35
12.1	Installation	35
12.2	Program Architecture.....	35
12.2.1	Toolbars.....	37
12.3	Quick starting	38
13	OPTIONS & ACCESSORIES	42
13.1	Printer operations	42
13.2	Sighting telescope system.....	42
13.3	Red Point pinpointing system	43
14	APPLICATION NOTES	45
14.1	Infrared energy	45
14.2	Applications	45
14.3	Emissivity.....	45
14.4	Reflected energy compensation	45
15	DIGITAL INTERFACE	46
15.1	Digital output wiring practice.....	46
15.2	TTL to RS 232 adapter	46
15.3	Communication protocol.....	47
15.3.1	Computer data request from OSP to PC	47
15.3.2	Computer data setting from PC to OSP.....	49
15.3.3	Communication programs.....	50
16	MAINTENANCE.....	52
16.1	Faulty operating conditions.....	52
16.2	Storage.....	52
APPENDIX.....		53
A1	How to determine an object emissivity	54
A1.1	Typical Emissivity Values	54
A1.2	Metals - Typical Emissivity Values.....	55
A1.3	Non-metals - Typical Emissivity Values	56

1 GENERAL DESCRIPTION

Portable infrared thermometers measure surface temperature without touching the surface. They collect the infrared energy radiated by a target and compute its surface temperature.

OMEGA OSP Series are portable infrared temperature devices designed to ease maintenance operations. They also enable the monitoring of operating temperatures of mechanical and electrical plants or production equipment without removing the equipment from the service.

Any temperature variation noticeable in whatever kind of system device should show critical overheating conditions which may cause malfunctioning to the device itself.

They are also useful to measure product temperatures during manufacturing, to spot problems before they reduce quality or cause production downtime.

Their principle of operation is very simple, the instrument determines the temperature of an object by measuring the amount of radiant energy emitted by it.

The detector, installed on each **OSP** unit, responds by producing a voltage signal which is directly proportional to the amount of energy received, and therefore is a function of the temperature of the target. By sampling and manipulating the output of the detector, the microcontroller-based electronics can display the temperature and the related computed values such as maximum, minimum, average, and difference temperatures seen during the measurement. The same information can also be stored and processed via Personal Computer (using electronic spreadsheets e.g. Lotus, Excel, Paradox, etc.). The displayed value can be printed out directly into an external printer supplied on request.

Thanks to its advanced optical system and electronics, **OSP** can be very useful for objects 5mm and larger and can operate in critical ambient conditions.

To take measurements by using **OSP** thermometers just pull the trigger and then point at the target to be measured. The trigger can be locked on if desired. For more distant targets, hold the unit at arm length and use the sighting notch and post to aim. This will give a parallel and offset sighting. Also Laser beam is available for sighting target.

Temperature information as well as auxiliary parameter pieces of information are shown on the high contrast liquid crystal display (LCD).

The case, made in shock-resistant ABS + polycarbonate, is ergonomically designed for an easy practical use.

The instrument is powered by a group of four alkaline or Ni-MH rechargeable batteries (AA type); an external battery charger module is supplied as a standard accessory.

OSP portable IR thermometers have been developed using the most advanced microcontroller technique to provide high accuracy on extended ranges and a powerful operating flexibility.

The calibration uses computerized procedures and the relevant calibration data are memory stored to ensure high accuracy.

General features

OSP non contact infrared thermometers are designed to simplify temperature measurements at distance from a target and to identify hot spots, which normally means anomalous operative conditions avoiding costly downtime or processing problems that lead to rejected products. There is no need to focus as required by photographic equipment. Accurate measurements result if **OSP** field of view diameter is smaller than the target.

Innovative design

This new line of portable instruments represents the most versatile and powerful infrared temperature system.

The most appropriate aiming system at the application can be selected with a twin laser pinpointing or with a combination of twin lasers and telescope or red point for true universal applications.

An on board data logger is available to store up to 500 data points, an analogue output can drive directly a recorder or a controller, The real-time temperature can be displayed together with the Maximum, Minimum, Difference and Average values.

Each model incorporates the following :

- high quality optical system
- high sensitivity infrared radiation detector
- auxiliary input for thermocouple type K and S
- microcontroller circuit
- high contrast LCD display with backlight device
- extended life traditional microswitch keyboard
- four alkaline or rechargeable Ni-MH type AA batteries
- external module for battery charge and/or line operation
- analogue output
- digital interface

1.1 Instrument codes

To Order				
Model No.	Temperature Range	Spectral Response	Target Spot Size @ Distance **	D/S Optical Ratio
OSP500-(*)	-30 °C to +930 °C -20°F to +1706°F	8 to 14 μm	10mm @ 600mm 0.39 @ 24"	60:1
OSP800-(*)	-30 °C to +930 °C -20°F to +1610°F	8 to 14 μm	10mm @ 600mm 0.39 @ 24"	60:1
OSP1000-(*)	-30 °C to +1000 °C -20°F to +1830°F	8 to 14 μm	10mm @ 1000mm 0.39 @ 39.4"	100:1
OSP1300-(*)	+300 °C to +1300 °C +570°F to 2370°F	1.6 μm	6mm @ 1000mm 0.236 @ 39.4"	167:1
OSP1600-(*)	+600 °C to +1600 °C +1120°F to 2900°F	1 μm	5mm @ 1000mm 0.20 @ 39.4"	200:1
OSP2000-(*)	+600 °C to +2000 °C +1120°F to +3630°F	1 μm	5mm @ 1000mm 0.20 @ 39.4"	200:1

* Insert suffix codes B and C and D from options chart above

** See Target spot size diagram

Note: all accessories and options must be specified at time of order.

Each Pyrometer supplied with: Alkaline battery, laser, operators manual, and calibration report

Options							
Suffix Code	Description	OSP500	OSP800	OSP1000	OSP1300	OSP1600	OSP2000
-B0	Alkaline battery	std	std	std	std	std	std
-B1	Rechargeable Battery	Opt	Opt	Opt	Opt	Opt	Opt
-C1	Single Laser	Std	No	No	No	No	No
-C2	Twin crossed Lasers	No	Std	Std	Std	Std	Std
-C3	Twin normal Lasers	No	Std	Std	std	Std	Std
-C4	Single Laser with Circle	Std	No	No	No	No	No
-D1	Vinyl Case	Std	Std	No	std	Std	No
-D2	Aluminum Case	Opt	Opt	Std	Opt	Opt	Std
-D3	Memory+Software+RS232 Cable	Opt	Opt	Std	Opt	Opt	Std
-D6	Sighting telescope	No	No	Opt	Opt	Opt	Opt
-D7	Red Point	No	No	No	Opt	Opt	Opt
-D8	Alarms	Std	Std	Std	std	std	Std
-D9	Analog Output	Opt	Std	std	std	std	Std
-DA	Aux Input for Tc K & S	Opt	std	std	std	std	Std
	Report of Calibration	std	std	std	std	std	Std

No = Not available

Std = Standard at no extra cost

Single laser: General application, target center

Single laser with circle: General application, target center plus target dimension with circle (short distance)

Twin crossed lasers: General application, target dimension

Twin normal lasers (parallel): Long distance application over 5m (16')

Red Point: High temperature over 1250°C 1x

Sighting Telescope: High temperature over 1250°C 2x tele

Software (D3): Includes memory up to 500 values. You can divide them by Tag (20 different). Each value includes temperature value and date&time (built in real time clock). Tag name with 7 characters on instrument display. Datalogging manual or automatic with sampling time from 1 to 999 sec. Windows 95 software to download data to PC and cable. You can view, save, print, export to Excel and graph data.

U.S. and international Patents and Patents Pending.

1.2 Specifications

Target dimensions at different distances

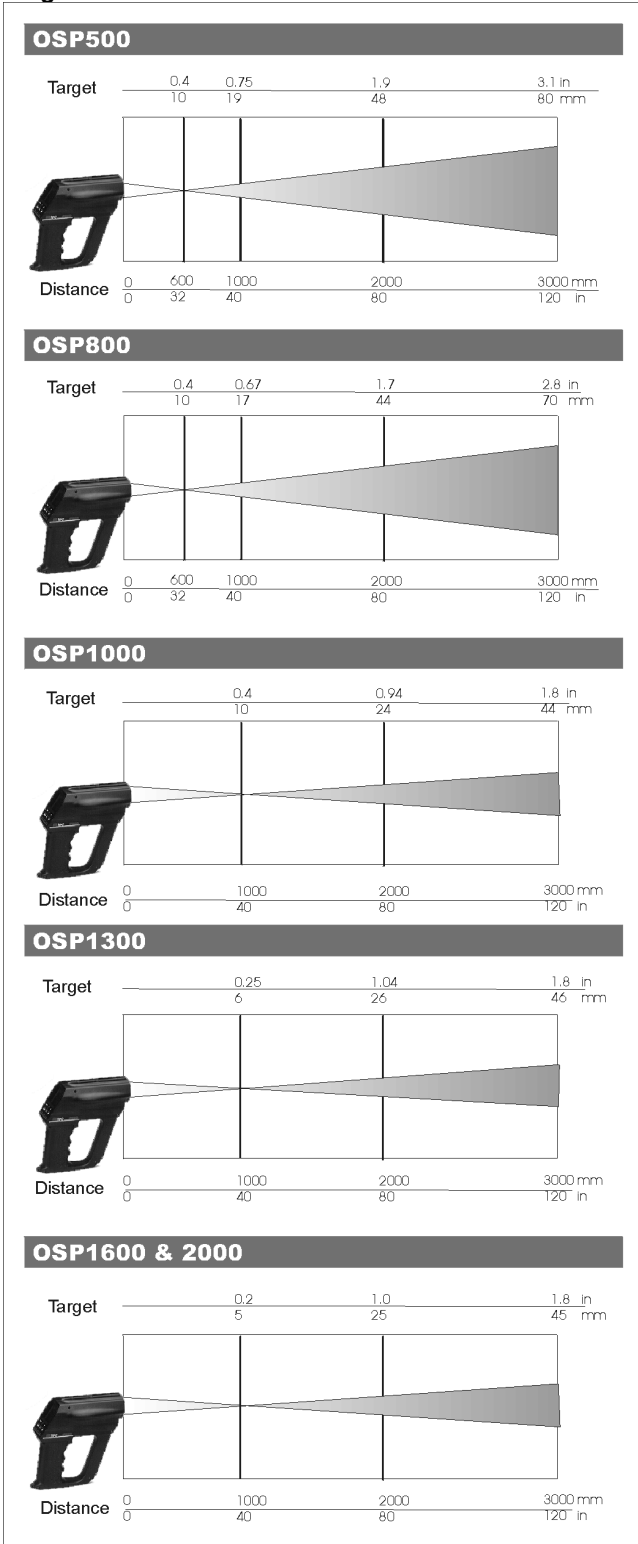

Nominal target diameter at 95% energy

- **Temperature measuring ranges:**
-30 to 2000°C (-22 to 3632°F)
- **Thermocouple measuring ranges:**
type K : -100°C to +1370°C (-148 to 2500°F) 0.1°C resolution
type S : 0°C to +1760°C (-32 to 3200°F) 0.1°C resolution
- **Spectral response:**
OSP 500, 800 & 1000 : 8 - 14 µm
OSP 1300 : 1.6 µm
OSP 1600 & 2000 0.9 µm
- **Accuracy:**
OSP 500, 800 & 1000 : ±(1% of the reading +1°C/2°F)
OSP 1300, 1600 & 2000: ±(0.5% of the reading +1°C/2°F)
- **Repeatability IR:**
OSP 500, P800 & P1000 : ±0.5% of the reading
OSP 1300, P1600 & P2000: ±0.25% of the reading
- **Temperature stability IR:**
for the band exceeding +18°C to +28°C: ±0.01% of f.s./°C
- **Display:**
High contrast custom LCD with backlight device
- **Display resolution:**
1°C / °F / K (0.1°C/0.1°F in AVG mode up to 200°C)
- **Alarms:**
Acoustic and visible
- **Measurement sampling time:**
<300 ms
- **Emissivity:**
Adjustable from 0.10 to 1.00 in 0.01 steps
- **Analog output:**
1 mV/ °C/ °F/ K
- **Digital interface:**
full bi-directional TTL level port
Optional TTL to RS232 adapter
- **Calculated functions:**
Hold, average, max, min, ΔT
- **Data memory:**
500 input data structured by tag
- **Calibration:**
self learning technique with automatic procedure
- **Laser:**
Wavelength: 650nm
Maximum optical power: <1mW
FDA Classification: Class II, Complies with 21CFR Chapter 1, Subchapter J
Safety classification: Class 2
Beam diameter: 3mm
Beam divergence: <0.5mrad
Laser indicator: asterisk on display
- **Power supply:**
alkaline or rechargeable type AA battery
- **Battery life:**
16 h (with backlight off)
- **Battery low level of charge:**
symbol on the LCD display
- **Line operation:**
100, 115, 230 Vac through the external charger
- **Charger transformer insulation:**
2500 V
- **Battery recharging time:**
8 h at 90% (instrument switched off)
- **Operating environment temperature range:**
from -10°C to +55°C (-14 to 131°F)
- **Storage temperature range:**
from -30 °C to +60 °C (-22 to 140°F) without battery
- **Case:**
Injection moulded ABS+ polycarbonate
- **Dimensions:**
200 x 180 x 80 mm (7.87 x 7.09 x 3.15")
- **Weights:**
net 0.8 kg (1.76 lb); gross 1.5 kg (3.3 lb)

2 GENERAL FEATURES

2.1 General

Temperature measurements of a liquid or gaseous compound have been successfully made with thermoelectric or expansion thermometers thanks to the good thermal exchange of the sensor with the fluid.

With solid bodies a good thermal exchange is difficult to be obtained and an additional measuring error should be considered.

A direct contact measurement is impractical when the object being measured is moving, it cannot be touched with a thermoelectric sensor because of electrical hazard or of other reasons.

A non-contact IR temperature measurement is the best solution to the above application problems.

Also other applications benefit because non-contact thermometers do not add or remove heat or disturb the process in any way, and there is no wear and tare on the instrument.

2.2 Optical System

The optical system is equipped with a main objective to focus the infrared energy into the infrared detector through a single lens, a filter and a field stop which defines the visual cone and therefore the target dimensions.

As the detector is placed in the focal point of the measurement portion of the optical system no focusing operations are required.

A secondary, but extremely important objective, is the correct pinpointing of the target as described below.

The optical diagrams are shown in the previous specification section.

2.3 Target pinpointing

A correct aiming at the target is an important factor of a non-contact thermometer. The immediate evaluation of the smallest measurable target area is also a positive key factor in many applications.

The following types of pinpointing are available :

- A "V" groove on the up side of the instrument can be used stretching the arm.
- Twin laser pointers to define, at distance, the measurable target dimensions. Two versions are available with crossing or parallel twin lasers. The twin crossed lasers are suggested for target distance upper than 5 meters.
- Combination of twin lasers and direct telescope viewing for universal applications mainly required for a high distance targets (more than 10 meters) and high temperature targets (more than 1000 °C) where laser spots are not visible .
- Combination of twin lasers and a red point pinpointing for universal applications mainly required for high temperature target where laser spots are not visible

With a laser pinpointing the operation of the instrument is extremely simplified. You simply aim at the target and read the temperature.

The installation procedures for telescope and red point pinpointing, please refers to the dedicated chapters.

2.4 Taking measurements

OSP portable thermometers are accurate, rugged and compact.

Its modern and practical design allows an easy handling and aiming, either at arm length or using a tripod mount, to obtain current temperature value, average, minimum, maximum and difference temperature measurement values.

Its analogue to digital outputs allows a continuous documentation on a continuous trace recorder or on a serial printer.

Using the keyboard it is also possible to enable the instrument to measure one of the computed values in addition to the actual temperature value measurement:

MAX	maximum temperature recorded during current measurement
MIN	minimum temperature recorded during current measurement
DIF	difference between MAX and MIN
AVG	average temperature for entire measurement
Tamb	ambient temperature

2.5 Keyboard

Traditional metal-click switches, with a working life of one million operations, are used to enter the operator's instructions. The contact closure of the keyboard keys is acknowledged, as a coded signal, directly by the microcontroller.



2.6 Display

The high contrast customised alphanumeric LCD display indicates the measured temperature value. It is also used for operators' messages, instrument configuration set-up, special operative modes, etc. It is equipped with a backlight device to allow easy readings even in poor light conditions.

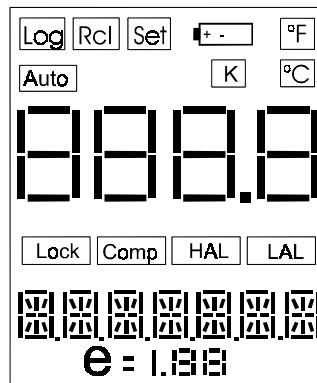

2.7 Digital Interface

A digital interface with TTL logic levels is available for communication with external units. A serial data port provides communication capability at a logic level of 0-5 V (four wires: Tx, Rx, GND, Vcc). A special software set enables the transfer of all the recorded data on a Personal Computer for further statistical analysis.

2.8 Self calibration

The hardware-firmware design allows the automatic calibration of the instrument. The calibration procedure is protected by a security code.

2.9 Thermocouple Input

To extend the operative capability the instrument is equipped with an auxiliary input for thermocouple. This feature, when used with a calibrated thermocouple, can be used to obtain accurate temperature measurements eliminating the problems of emissivity and the interfering light. The thermocouple can be used to obtain an accurate temperature reading of the target material and then these data are used to determine the compensation value for the actual emissivity, including the interfering light, within a range from 0.10 to 1.00.

2.10 Analog Output

An analog output (1 mV/°C/°F/K) is available to drive an external analog input device (eg. a potentiometric or hybrid recorder) for long term trend profiling and tests.

In this case the instrument can be powered directly from mains using the external power supply module supplied with the thermometer.

2.11 Logging Mode

The instrument can be equipped with an internal memory to store up to 500 input data. Two types of data acquisitions can be selected by the user.

Continuous acquisition

The operator can select the interval time between each acquisition and store progressively the input data in the Tag file or can manually, step by step, give the acquisition instruction.

Acquisition by dedicated tag

Standard Agencies and Quality Auditors require the collection, organization and availability of traceability documents. A supporting software is available to transfer a selection of plant inspections from a PC to the internal memory of the instrument in order to simplify field check and select the appropriate tag number. Dedicated input data are memory stored and downloaded into a PC to document the inspection activity. Data can be saved on disks, viewed and printed in a numeric or graphic mode.

2.12 Calculated Measurements

For the measurement of unstable input signals by a progressive averaging with a programmable average weight. In addition the operator can select average, minimum, maximum, Tmax -Tmin, differential.

2.13 Case

The case of the instrument is ergonomically designed for an easy hand held operation and transport. The body is injection molded, shock-resistant, flame proof ABS+ polycarbonate. A vinyl case with shoulder strap and an aluminum case for instrument + printer + accessories are available on request.

2.14 Logging Data Manager

LogMan software allows the OSP series users to set and prepare the infrared thermometers to acquire the data organized by 'Tag'. This software also allows to download data from Instrument on document (table) with date, time and value. You can view table, save table, print table, export table in excel-txt-html and obtain graph. You can also manage data coping, moving on other tables.

3 PHYSICAL DESCRIPTION

OSP portable IR thermometers consist of a rugged, compact and self-extinguishing case ergonomically designed for an easy practical use.

The instrument can be supplied either with a vinyl protective case with shoulder strap or with an aluminum case to assure better protection against mechanical knocks or scratches.

The battery container is located on the lower part of the handle, and is accessible through a cover fastened by a metal screw.

4 FUNCTIONAL DESCRIPTION

OSP series infrared portable thermometers block diagram is shown below:

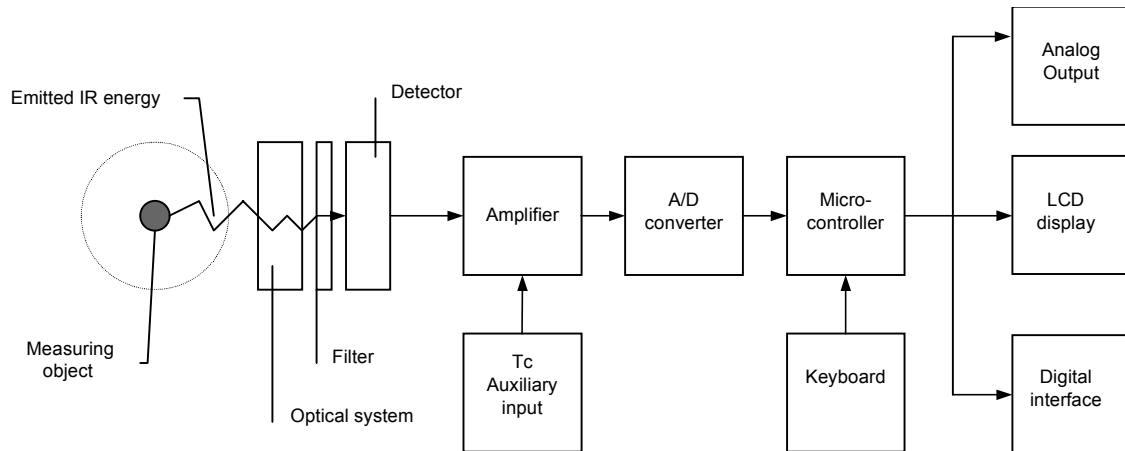

- **Optical system**
- **Filter**
- **Detector**
- **Amplifier**
- **A/D converter**
- **Microcontroller**
- **LCD display**
- **Digital interface**
- **Keyboard**
- **Tc auxiliary input (optional)**
- **Analog output (optional)**

The radiated infrared energy is focused by the optical system on an infrared detector sensitive to the required spectral band. The infrared detector generates a signal proportional to the energy received corresponding to the temperature and emissivity of the target. See Appendix A for emissivity values.

The output signal of the sensor is then conditioned, converted from analog to digital and transmitted to the microcontroller. The procedures used to process all the operating functions as well as measure and calculation routines are stored into the microcontroller memory. Any operator's instruction, through the trigger and the keyboard is directly recognized, as a coded signal, by the microcontroller. The actual temperature value and the active operative mode are indicated on the LCD display.

4.1 Power supply

The instrument is powered, if not otherwise specified with the order, by four internal alkaline batteries or rechargeable Ni-MH type AA (nominal voltage 1.25 V) that can be recharged through an external charger module supplied as a standard accessory.

4.2 Keyboard

The operative keyboard is designed with a traditional single microswitch per button for long life and high reliability. The contact closure of the keys is acknowledged as a coded signal by the microprocessor that recognizes the operator's instructions.

4.3 Microcontroller

The microcontroller handles all the logic functions of the instrument, performs the linearization for non linear transducers, compensates for the reference junction temperature, drives the digital display and acknowledges all the operator's instructions.

The core of the circuit is a single-chip microcomputer that utilizes HCMOS technology to provide the low power characteristics and high noise immunity of CMOS plus the high speed operation of HMOS.

The microcomputer provides highly sophisticated, on-chip peripheral functions including: 256 bytes of static RAM, an 8 channel analog to digital (A/D) converter (used to read the R_j value, the setting of the input comparator, the battery package voltage and the value of the auxiliary input), a serial communication interface (SCI) subsystem, and a serial peripheral interface (SPI) subsystem.

The microprocessor works with an 8-bit communication bus to EPROM and EEPROM memories and is interfaced with a decoder, a latch of address and an inverter-driver.

4.4 Firmware

The operating system firmware handles all the logic instructions to the internal peripheral circuits and performs the computation of the linearization equations.

The application system firmware is resident on the non-volatile memory (EEPROM) of the microprocessor chip. It is used to store the installation parameters (autocalibration data, program data, etc.)

4.5 Display

The custom display, placed on an auxiliary board, uses high contrast LCD technologies (STN liquid). **OSP** thermometers are standard equipped with a backlight device for easy readings in poor light conditions.

4.6 Battery charger

The auxiliary module, supplied as a standard accessory, allows operations from 115 Vac 50/60 Hz. **OSP**, if needed, can be operated directly from a line source through the charger.

The plastic case of the battery charger incorporates the line voltage plug and a cable with a connector for interconnections to the instrument.

The charger circuit is designed with an insulating transformer and a voltage stabilizer circuit. The step-down transformer reduces the power line 115 Vac to a value of 10 Vac. The above voltage is full wave rectified, filtered and stabilized. The output voltage of 5.6 Vdc is the ideal value to recharge the internal Ni-MH batteries

4.7 Digital interface

The digital interface circuit is essentially based on the serial communication interface subsystem (SCI) on the chip of the microprocessor at 0 / +5V level. Adapters to convert TTL to RS 232 voltage levels are available from OMEGA.

5 UNPACKING

Remove the instrument from its packing case and remove any shipping ties, clamps, or packing materials.

Carefully follow any instruction given on any attached tags.

Inspect the instrument from scratches, dents, damages to case corners etc. which may have occurred during shipment.

If any mechanical damage is noted, report the damage to the shipping carrier and then notify OMEGA directly or its nearest agent, and retain the damaged packaging for inspections.

A label indicates the serial number of the instrument.

Refer to this number for any inquiry for service, spare parts supply or application and technical support requirements.

OMEGA will keep a data base with all information regarding your instrument.

6 PRE-OPERATIONAL CHECK

OSP series portable thermometers are powered either by four alkaline or by Ni-MH rechargeable batteries (optional). The external battery charger, supplied as a standard, is set for 115Vac power source. Before using the instrument carefully verify the nominal voltage value of the charger with the available mains power line. The instrument should be used in environments where the temperature does not exceed the specified limits (from -5°C to +50°C) and where the relative humidity is lower than 95%.

In case of "low" battery conditions (voltage lower than 4.6 V) the display will show the appropriate symbol. A battery symbol means that the battery package has enough energy for about 20 minutes operation. In this condition the instrument batteries must be recharged.

WARNING

**USE OSP IR PORTABLE THERMOMETERS TO MEASURE TEMPERATURE: 0.9 - 1.1 μm (OSP1600, OSP2000), 1.6 μm (OSP1300) AND 8-14 μm (OSP800, OSP1000 AND OSP500) SPECTRAL BANDS.
IN CASE IR THERMOMETER SHOULD MEASURE DIRECT OR REFLECTED HIGH INTENSITY RADIATIONS IN THE ABOVE SPECTRAL BAND, THEY CAN DAMAGE PERMANENTLY THE IR SENSORS INSIDE THE THERMOMETERS.
THIS KIND OF RADIATION CAN BE PRODUCED BY EITHER THE LASER TYPE Nd :YAG ($\lambda_{EM} = 1.06 \mu\text{m}$) OR BY THE LASER TYPE CO₂ ($\lambda_{EM} = 10.6 \mu\text{m}$).**

7 POWER SUPPLY

The instrument may be powered by alkaline or rechargeable batteries or directly from the main line. **OSP** uses 4 batteries type AA that are located inside the base of the handle.

7.1 Rechargeable batteries

The rechargeable batteries are shipped with an average level of charge. After unpacking, a full charge of the batteries is recommended. Connect the instrument to the charger module ("OFF" condition) for a period of 10 hours minimum.

The Ni-MH rechargeable batteries do not suffer when used in cyclic operations. The cyclic operation is understood as a method of operation by which the battery is continually charged and discharged.

Avoid leaving the instrument, with batteries totally or partially discharged, for a long time without recharging them.

To charge the batteries use only the original supplied charging module. The module incorporates protection and current limiting devices not normally found in other commercial chargers.

The external battery charger is configured, before shipment, for a supply voltage of 115 Vac, upon order specification. The nominal voltage value is indicated on the front label of the charger.

7.1.1 How to maximize the life span of the battery

Disconnect the ac mains supply when the battery is charged. Use the battery until it is completely discharged. Leaving the ac mains charger plugged in during operations will decrease the life of the Ni-MH batteries. Keeping the battery terminal clean will help maximize the operating time. Periodically wipe the positive and negative terminals with a dry cloth. Removing and replacing the batteries will ensure electrical contact. This should be done when using a battery that has not been used for a long time.

Note that the operating time decreases at low temperatures. A Ni-MH battery can be recharged about 500 times when used with the recommended instructions. When replacing the Ni-MH batteries with a new set always replace simultaneously the four pieces.

7.2 Power supply with alkaline batteries

Power supply with alkaline batteries must be specified with the order.

7.3 Power supply from main line AC

The battery charger module can be used to power the instrument for continuous operations from main line AC. Rechargeable batteries or alkaline batteries are not required to be removed with AC power supply.

8 WARNINGS & CAUTIONS

8.1 Laser Sight

You may receive harmful laser radiation exposure if you do not adhere to the warnings listed below:

- **USE OF CONTROLS OR ADJUSTMENTS OR PERFORMANCE OF PROCEDURES OTHER THAN THOSE SPECIFIED HERE MAY RESULT IN HAZARDOUS RADIATION EXPOSURE.**
- DO NOT LOOK AT THE LASER BEAM COMING OUT OF THE LENS OR VIEW DIRECTLY WITH OPTICAL INSTRUMENTS – EYE DAMAGE CAN RESULT.
- USE EXTREME CAUTION WHEN OPERATING THE LASER.
- NEVER POINT THE LASER BEAM AT A PERSON.
- KEEP OUT OF REACH OF ALL CHILDREN.

CAUTION - LASER SAFETY

**LASER RADIATION - DO NOT STARE INTO BEAM
CLASS 2 LASER PRODUCT CONFORMS TO IEC 823/93
CLASS II LASER PRODUCT COMPLIES WITH 21 CFR CHAPTER 1, SUBCHAPTER J.
WAVELENGTH: 630-670nm – MAX. OUTPUT: <1mW**

WARNING

**DO NOT ATTEMPT TO OPEN THE LASER SIGHT MODULE.
(THERE ARE NO USER-SERVICEABLE PARTS IN THE MODULE).**

8.2 Analogue input

Thermocouple input is optional for OSP series thermometers. The sensors are normally linked to electrical potentials equal or near to the ground potential. However, in some applications, there may be present a common mode voltage to ground. Check for voltage between input terminals and the ground, as this voltage can be transmitted to other devices connected to the OSP series temperature indicator.

8.3 Danger and Certification Labels

The laser sight is standard in your thermometer. You can choose between different laser systems as described in section 1.1. Laser provides a visual indication of the field of view of the thermometer. The following figures show the parts and the labels locations of the Laser sight module.

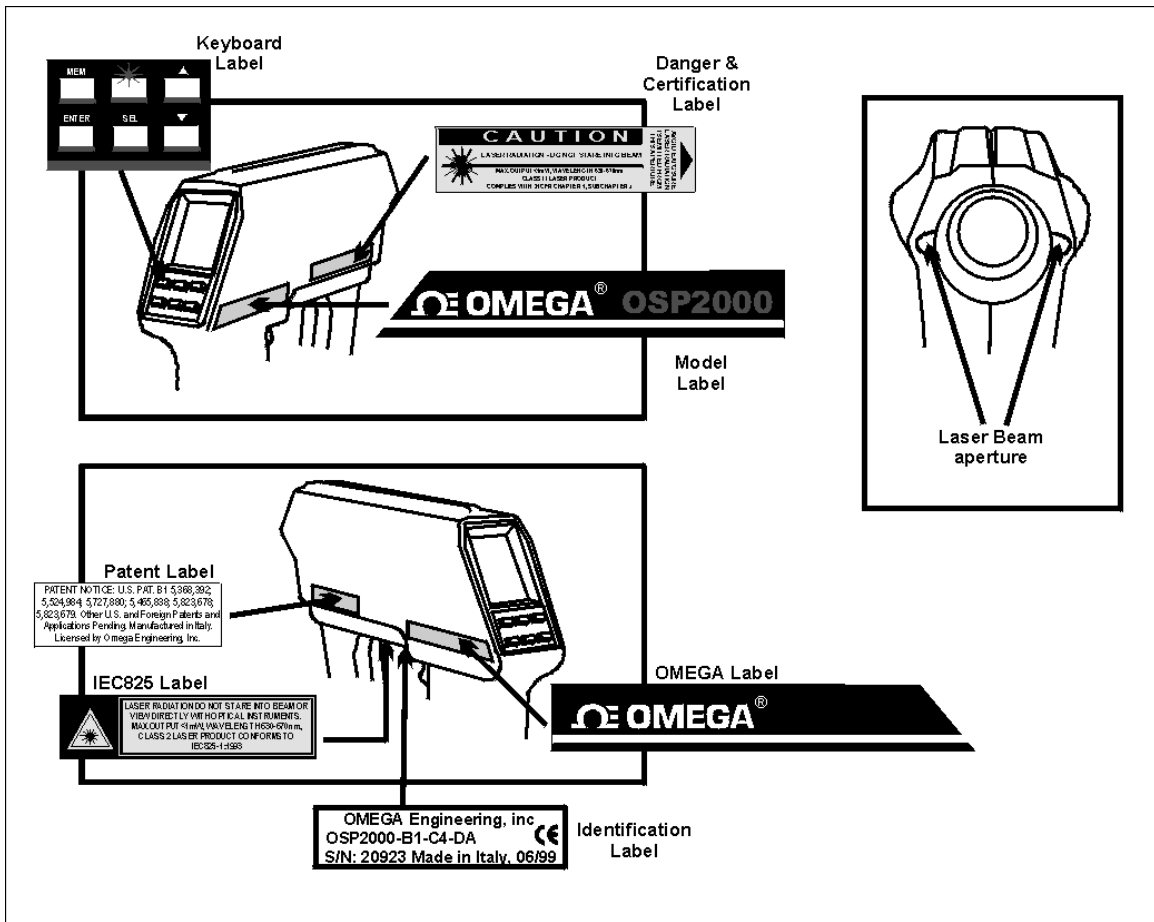

9 OPERATIONS

OSP series portable infrared thermometers are factory calibrated before shipment.

During the start-up the operator should only select and load, if required, the pertinent application parameter as described in the following paragraphs.

Before entering the procedure to operate the instrument it is useful the understanding of the messages that can be present in the display.

The following figure shows the overall layout of the display and an explanation of each symbol or message :

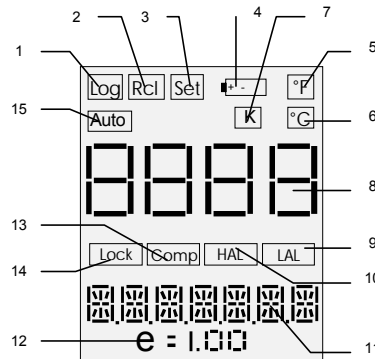

- 1 - Indicates logging mode operative
- 2 - Enables recall of memory stored data
- 3 - Indicates the setting mode enabled during configuration and logging mode set up
- 4 - Low battery indication
- 5 - Temperature in degree Fahrenheit
- 6 - Temperature in degree Celsius
- 7 - Temperature in Kelvin
- 8 - Actual measured temperature value
- 9 - Indicates Low Alarm
- 10 - Indicates High Alarm
- 11 - Auxiliary measurement data or setting (AVG, LAL, HAL, MIN, MAX, DIF) or thermocouple input indication
- 12 - Operative emissivity value
- 13 - Ambient temperature compensation
- 14 - Continuous measurement mode
- 15 - Automatic acquisition in logging mode

The contact closure of the keys is acknowledged as a coded signal by the microprocessor that recognizes the operator's instructions.

- <Trigger> Keep pressed for operation. Press twice, in sequence, to hold the instrument -ON-
- <▲> <▼> Value setting or data selection during Configuration or Set-up procedures
- <*> Laser sighting on/off or data acquisition mode set-up
- <MEM> Data acquisition operation and logging manual step
- <SEL> Selects the operative mode
- <ENTER> Memory load key

9.1 Quick Start

To use the **OSP** infrared thermometer right away follow this simple steps :

Point the instrument at the object you want to measure and pull the trigger (the actual temperature value, the pre-programmed emissivity value and the auxiliary indication will be displayed); a "LOCK" symbol will appear on display.

Set emissivity value using the <▲> and <▼> keys. Refer to appendix A to define emissivity and for emissivity tables.

Press and release the trigger to switch the unit off.

9.2 How to Operate the instrument

To switch the instrument "On" keep the trigger pressed; when the trigger is released the instrument will be switched "Off". When continuous operations are required press twice, in sequence, the trigger to lock the operative mode.

The first display indication will show the type of instrument and the temperature technical unit enabled.

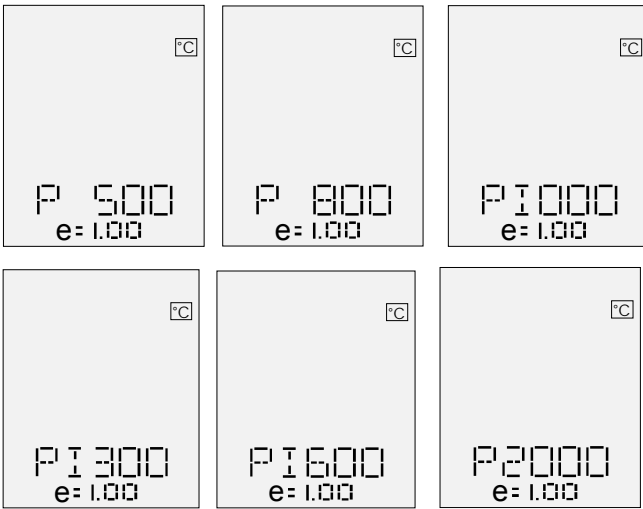

followed, after few seconds, by one of the main operative display pages.
The displayed page will be the same as when the instrument was switched Off

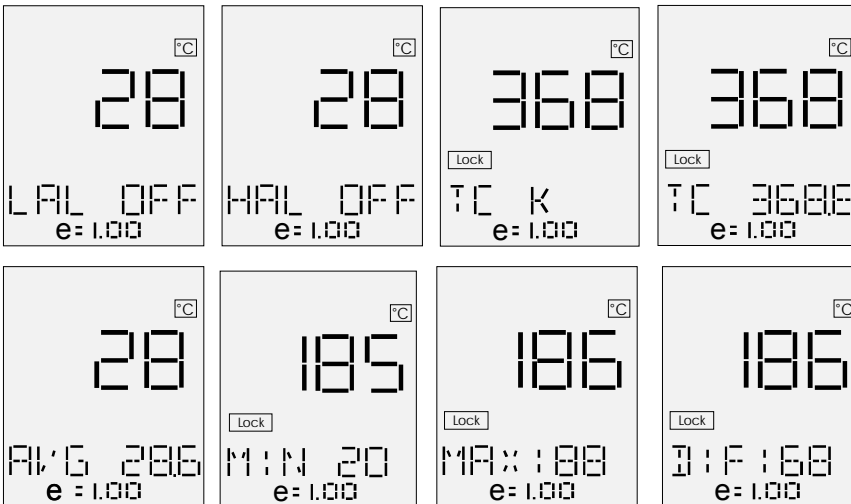

- Press the <SEL> key to select the required page.
- Press the <▲> and <▼> keys to adjust the emissivity value as required by the application.

9.3 Hold

To hold the measurement, press the <MEM> key; the “X” symbol will be displayed on lower display.

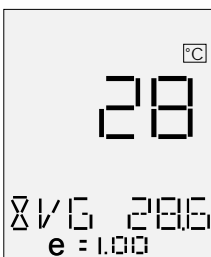

To run in continuous measurement, press the <MEM> key another time.

9.4 Laser sighting

CAUTION: BEFORE USING THE LASER SIGHT READ THE RECOMMENDATIONS ON PARAGRAPH 15.2.2.

In measuring mode, press the <*> key to enable (disable) the laser spot. After one second the message “LAS EN” (“LAS DIS”) will be displayed.

When enabled, the laser can be turn on by pressing the <Trigger> button for more than 1 second; a flashing emission indicator symbol “*” will appear on the lower display.

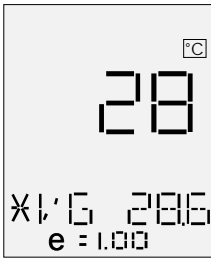

The laser will go out automatically releasing the <Trigger> button.

NOTE: TO PREVENT ANY COLLATERAL RADIATION IN EXCESS OF THE LIMITS DURING THE OPERATION OR MAINTENANCE, THE LASER BEAM WILL AUTOMATICALLY SWITCHED OFF WHEN TRIGGER IS RELEASED (ALSO IN LOCK OPERATION MODE).

9.5 Unstable temperature measurement

When measuring a very unstable temperature process, is necessary a slow and stable reading. **OSP** is equipped with an advanced average mode that works with the following parameters :

- Working band
- Weight

The working band is used to define the maximum difference between the actual and previous measurement values where average mode has to be operative. It means that if you are measuring ambient temperature (for example 23°C) and you point the instrument to the process (for example 600°C) you don't need a slow increasing due to average (The difference is $600 - 23 = 577$ °C).

If working band is set at 100°C instrument don't apply any average and it will pass directly to temperature of the process (600°C) otherwise with standard average you will see the temperature slowly growing from ambient to the target point.

When instrument is measuring the process the difference due to unstable temperature is inside working band so it will works in average mode.

More unstable is the process higher has to be the weight of the average. Higher is the weight ,slower will be the reading.

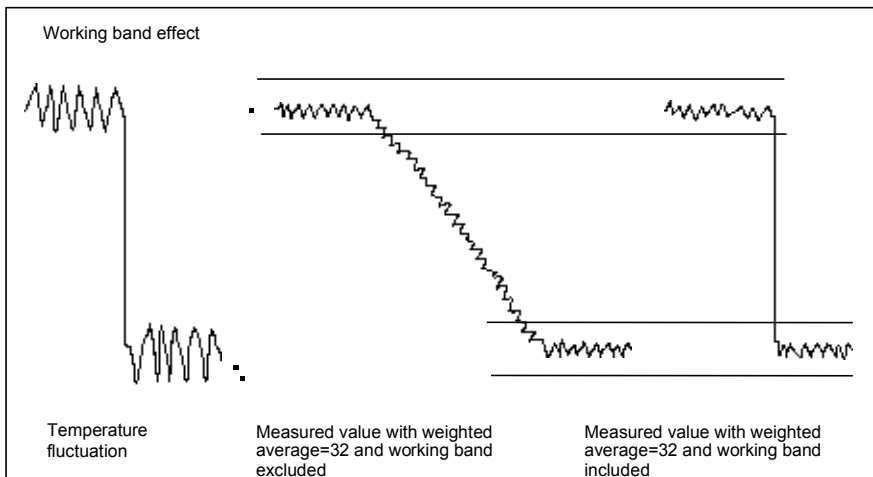
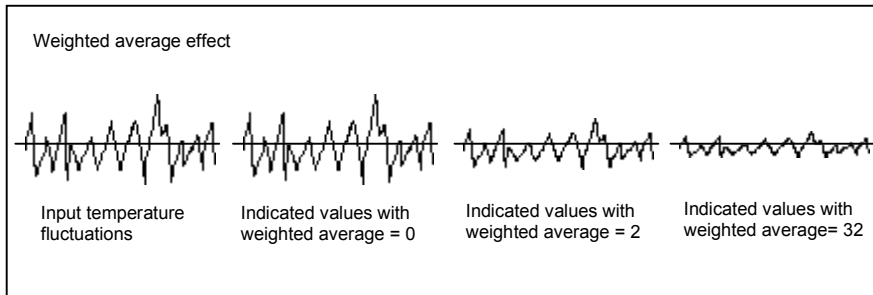

To enable/disable the average mode follows the procedure below:

- In measuring mode, press the <Sel> key until the following page will appear:



The display indicates the actual temperature value together with the technical unit symbol, the programmed emissivity value and the averaged temperature value.

- At this stage press <ENTER> key to enable the average mode. On the display will appear the following page:

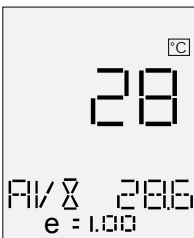

The average mode is now enabled; the "X" symbol will appear. It will remain enabled after the instrument switching off. To disable the average mode, repeat the above procedure. The "X" symbol will disappear. Average mode will remain enabled also in data acquisition mode and in peak mode operations.

The standard programmed values on OSP are: **working band**=100°C and **average weight**=32 that are parameters valid in most of your process applications.

To change the parameters setting, use the optional **Average** software for personal computer and TTL/RS232 cable.

9.6 Alarm settings

Low and High Alarm levels can be programmed and used in "hot spots" for fast scanning or long term surveillance. To select these operative modes press, in sequence, the <SEL> key to obtain the following display pages :

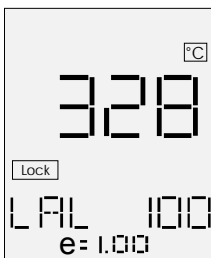

To change the Low and/or High Alarm settings follow the procedure indicated below :

- Press the <ENTER> key to enter the setting procedure. One digit of the setting line will blink. The blinking digit allows a new adjustment.
- Press the <SEL> key to select a different digit or the polarity (+/-)
- Press <▲> and <▼> keys to modify the value of the blinking digit
- Repeat the last two steps to set the new alarm threshold
- Press the <ENTER> key to return to the normal operative mode with the new Low Alarm setting

If required the Low Alarm can be excluded setting the low alarm level above the full scale temperature value where the message -Off- will appear.



- Press the <SEL> key to obtain the following page that enables the High Alarm setting



- Repeat the setting procedure used for the low alarm setting

If required the High Alarm can be excluded setting the high alarm level above the full scale temperature value where the message -Off- will appear.



An alarm status, as shown in the above figure, will be announced to the operator by the -HAL- or -LAL- message on the display and, simultaneously, by an acoustic signal.

- The acoustic signal can be acknowledged with the <MEM> key.

9.7 Thermocouple input

To select these operative modes press, in sequence, the <SEL> key to obtain the following display pages :



- Press <▲> and <▼> keys to select the required type of thermocouple (type "S" or type "K"). This auxiliary input can be used for contact temperature measurements or for automatic emissivity adjustments.

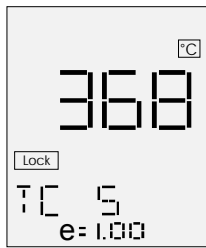

- When selected the required type of thermocouple press the <SEL> key to obtain the following page showing simultaneously both the actual IR temperature and the temperature measured with the thermocouple.

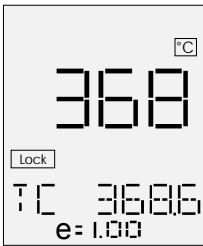

If the measuring thermocouple is not connected or is broken, the display will indicate "Tc OTC".



If the auxiliary input is disable, the display will indicate "Tc OFF".

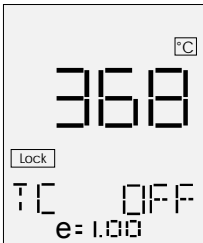

9.8 Minimum, maximum, average and difference indication

- Press the <SEL> key to obtain one of the following indications showing, in the auxiliary display, respectively the Minimum or Maximum value recorded in the interval time from the instrument switch -On- and the calculated Difference value between the identified Maximum and Minimum values.

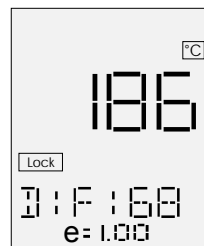

When positioned on the max or min function, use <ENTER> key to reset the stored value.

9.9 Automatic Emissivity Setting

This function is used to make an automatic setting of emissivity using an external thermocouple connected with the auxiliary input.

- If necessary, enable the thermocouple input (see par. 9.2) and select the thermocouple type (see par. 8.6)
- Press the <▲> or <▼> key until the thermocouple temperature measure is displayed



- Press <ENTER> key for setting the emissivity value with reference to the temperature values read from thermocouple and pyrometer. The emissivity will change automatically to the correct value by the OSP.



- An error message appear if the **OSP** measure a temperature highest of the thermocouple. If the error happen, verify the contact between the thermocouple and the object.

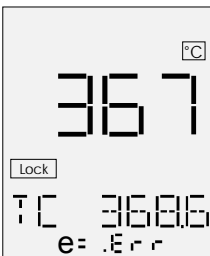

10 CONFIGURATION

The operative configuration of the unit can be changed using the below indicated procedure.

- Switch the instrument **-Off-**
- Keep the **<ENTER>** key pressed and press the **<Trigger>** push button until the instrument displays the indication relevant with the technical unit selection.

10.1 Technical Unit selection

the display will indicate one of the following technical units (Celsius, Fahrenheit and Kelvin):

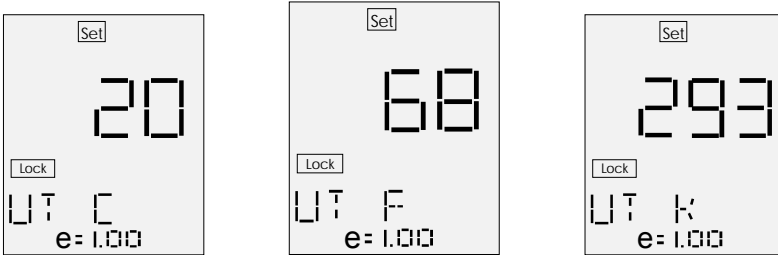

- Press the **<▲>** or **<▼>** key if you require to select a new technical unit
- Press the **<SEL>** key to select the new configuration step or press the **<Trigger>** to switch the instrument **-Off-**. The new selection will be automatically memory stored.

10.2 Thermocouple input enabled

Press the **<SEL>** key until the following indication is displayed :

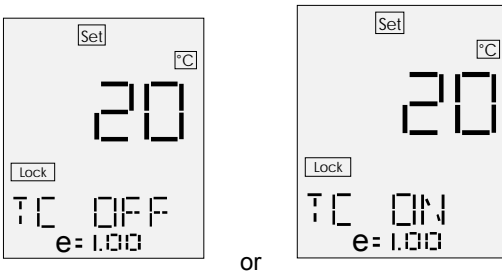

- Press the **<▲>** or **<▼>** key to enable (or to disable) the thermocouple auxiliary input operation.
- Press the **<SEL>** key to select the new configuration step or press the **<Trigger>** to switch the instrument **-Off-**. The new selection will be automatically memory stored.

10.3 Temperature Scale selection

Press the **<SEL>** key until one of the following indication is displayed :

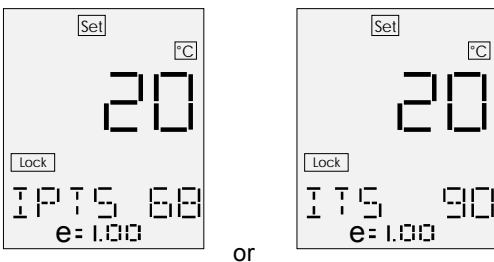

- Press the **<▲>** or **<▼>** key to select the required International Temperature Scale.

- Press the <SEL> key to select the new configuration step or press the <Trigger> key to switch the instrument -Off-. The new selection will be automatically memory stored.

10.4 Date & Real Time clock setting

The two following pages allow respectively date and real time updating .

- Press the <SEL> key to display the date page



- Press the <ENTER> key to enable the adjustment
- Press the <SEL> key to select the parameter to be modified (day, month, year)
- Press the <▲> or <▼> key to modify the selected parameter (blinking)
- Press the <ENTER> key to acknowledge the new setting
- Press the <SEL> key to enter the real time clock page



- Press the <ENTER> key to enable the adjustment
- Press the <SEL> key to select the parameter to be modified (hour, minute, second)
- Press the <▲> or <▼> key to modify the selected parameter
- Press the <ENTER> key to acknowledge the new setting
- Press the <SEL> key to select the new configuration step or press the <Trigger> to switch the instrument -Off-. The new selections will be automatically memory stored.

10.5 Acquisition settings

- Press the <SEL> key until the following indication is displayed :



- Press <ENTER> for setting the acquisition mode;
- Press the <▲> or <▼> key to select the required setting: MAN, MIN, MAX or interval time for automatic acquisition ;

NOTE: MANUAL MODE DISPLAYS THE REAL TIME TEMPERATURE VALUES AND PERMITS TO STORE THE VALUE PRESSING THE <MEM> KEY. MAX (MIN) ACQUISITION MODE DISPLAYS ONLY THE MAXIMUM (MINIMUM) VALUE AND PERMITS TO STORE THE VALUE PRESSING THE <MEM> KEY.

- To change the interval time for automatic acquisition, press <SEL> to change decade and the <▲> or <▼> key to change its value.
- Press <ENTER> to store the new acquisition mode. See Cap. 11 for appropriate data acquisition operation.

10.6 Buzzer On/Off

If the Alarms option is installed, it is possible to switch the buzzer on or off. This page allows the set-up of the acoustic signal.

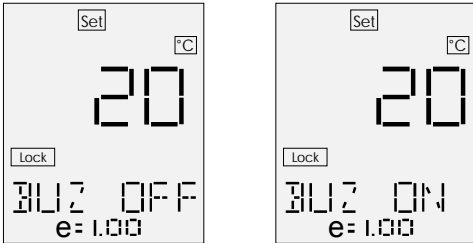

When the “Buzzer” is switched -Off- the alarm conditions will be announced only with the relevant -HAL- or -LAL- message on the display.

10.7 OSP 500/800 decimal point selection

NOTE: THIS FEATURE WORKS ON OSP 500 OR OSP800 WITH FIRMWARE FROM VERSION 4.001.

It is possible to display the temperature measured with a decimal digit. The following procedure is used to enable the operating mode.

- Switch the instrument off.
- Keep pressed <*>+<SEL> keys and switch the unit on by pressing the <Trigger> key. The temperature measurements will be displayed with the decimal digit.

Repeat the above procedure to disable the operating mode.

10.8 Ambient Temperature Compensation (TAM)

This function is used to compensate the measure from the ambient temperature.

Targets which have low emissivity will reflect energy from their surrounding environments, which is going to add to their own emitted energy. If the temperature of the surrounding environment is the same value as the internal temperature of the unit, there is no need to consider this value as it is automatically and continually measured. However, in some industrial situations the surrounding environment (machines, furnaces, or other heat sources) has a much higher value than the one of the internal of the unit temperature. The table below "*Effect of TAM on Accuracy*" underlines these effects on measurement accuracy, with and without the use of the Ambient Temperature Compensation mode.

The Ambient Temperature Compensation mode should be used whenever the stated following points are true :

1. The target has a low emissivity.
2. Temperatures of objects facing targets are much hotter than the temperature of the unit.
3. An increased measurement accuracy is required

Actual Target Temp.		Emissivity	Ambient Temp.		Indicated Temp. w/o TAM		Indicated Temp. w/ TAM	
°C	°F		°C	°F	°C	°F	°C	°F
100	200	0.8	25	80	100	200	100	200
100	200	0.8	40	100	102	203	100	200
100	200	0.8	150	300	120	250	100	200
100	200	0.6	150	300	160	321	100	200

Note : The internal temperature of IR thermometer is assumed to be 25 °C (80 °F)

- Press the <SEL> key until one of the following indications is displayed :

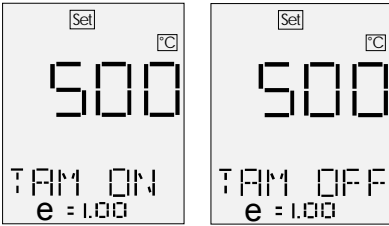

- Press the <▲> or <▼> key to enable (or to disable) the thermocouple auxiliary input operation.



- With the compensation function activated, press <ENTER> to begin the measurements in order to calculate the ambient temperature average value. Point **OSP** towards objects and surfaces surrounding the target, making a scan over those items and acquiring corresponding temperature values. A counter (from 1 to 255) indicates the number of measurements considered (**OSP** displays the first value read during this procedure). These acquisitions have to be done with emissivity $\epsilon=1$, hence when acquisition starts the emissivity value has set automatically to one.
- Press <ENTER> to stop acquisition and to confirm the read ambient temperature (at this moment **OSP** will display the last acquired temperature value).
- Press the <SEL> key to select the new configuration step or press <Trigger> to switch the instrument off. The new selections will be automatically memory stored.

To execute the temperature measurements with TAM, switch **OSP** on and set the emissivity to the correct target value.

10.9 Firmware revision number

- Press the <SEL> key until the following page is displayed :



The above page indicates the version of the firmware installed in your instrument. This information is extremely important in all inquires for technical assistance support.

10.10 Instrument serial number

- Press the <SEL> key until the following page is displayed :



The above page indicates the serial number of the instrument. Such number is extremely important for any request of technical assistance support.

10.11 Battery level of charge

- Press the <SEL> key until the following page is displayed :

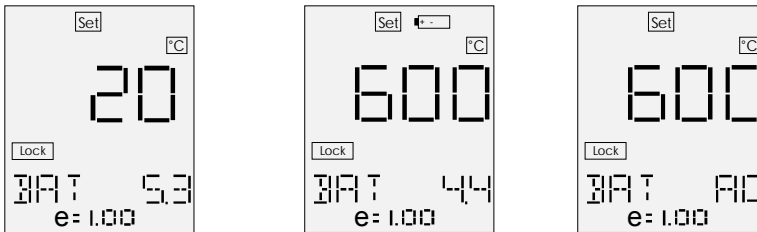

The above pages indicate the status of power supply and the level of charge of the battery.

When a voltage lower than 4.6V is present a low battery symbol is also displayed.

If the instrument is connected to the main line for battery charge or long term continuous operation a symbol "AC" will be displayed instead of the battery voltage value.

11 DATA ACQUISITION OPERATIVE MODE

When the optional accessory of the instrument is specified (Internal data memory + RS232 adapter + LogMan software) the instrument is equipped with an internal memory to store up to 500 input data records. Two types of data acquisitions can be selected by the user.

Continuous acquisition

The operator can manually, step by step, store his data through the keyboard or can select the interval time between each acquisition and store progressively the input data in the "Tag 0" file.

Acquisition by dedicated Tags

Standard Agencies and Quality Auditors require the collection, organization and availability of traceability documents. A supporting software is available to transfer a selection of plant inspections from a PC to the internal memory of the instrument in order to simplify field check and select the appropriate Tag number. Dedicated input data are memory stored and downloaded into a PC to document the inspection activity. Data can be saved on disks, viewed and printed in a numeric or graphic mode.

A full description of this acquisition mode is available with the dedicated software. To operate in continuous acquisition mode, refer to the following procedure.

11.1 How to operate in data acquisition mode

- Start this procedure with the instrument switched -Off-
- Keep the <MEM> key pressed and, simultaneously, press the <Trigger> until the following indication is displayed :



- Press the <▲> or <▼> key to select the required Tag identification code (Tag 0 or one out of the 20 available Tags from "A" to "S"). Parameters (emissivity, low and high alarm settings) can be set through keyboard only in Tag 0. Other Tags are reserved to operation through the dedicated PC software.

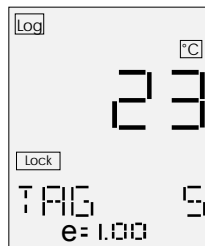
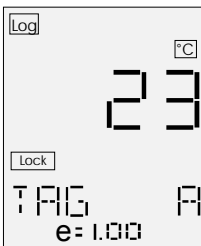

- Press the <SEL> key to display the number of memory locations still available (500 indicates a full empty memory).



Data can be recorded in the selected Tag in manual or automatic mode. Manual acquisition mode can be selected between normal (MAN), MAX or MIN. About acquisition mode and setting of time acquisition, refer to par. 9.5.

- Press the <MEM> key to start the acquisition.
 If automatic acquisition mode is set, **OSP** acquires automatically with the programmed time interval.
 If MANual mode is set, the real time temperature measurement is displayed; press the <MEM> key to store the displayed value.
 If MAX or MIN mode is set, the maximum (minimum) temperature measurement is displayed; press the <MEM> key to trigger acquisition and the <ENTER> key to reset the value for the next acquisition.
- Press the <SEL> key to obtain the page that allows the clearing of the memory stored data :



- Press the <ENTER> key to clear the memory content and to obtain the following message that require confirmation :



- Press the <ENTER> key to confirm the cancellation request and to obtain the following message :

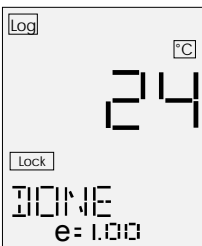

- Press the <SEL> key to obtain the following page indicating the identification code (or name) assigned to the active Tag (zzzzzzz = Furn686 = Trap888). The identification code is selectable only through software.

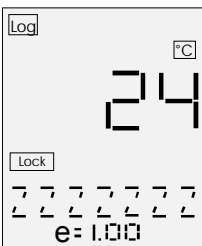

- Press the <SEL> key to review the pages relevant with -HAL- and -LAL- alarm settings. To modify the alarm level in the data acquisition mode see the paragraph 10.2.

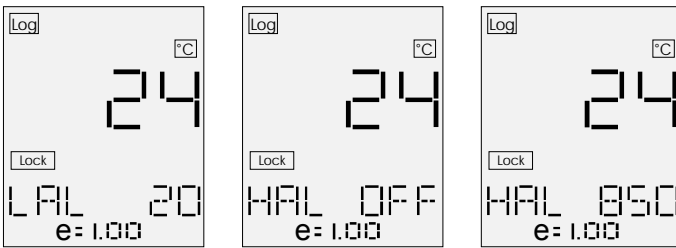

11.2 Recall stored data

- Switch off the **OSP** thermometer.
- Keeping pressed the **<SEL>** key, press the **<Trigger>** key to obtain the following indication :



- Press the **<▲>** or **<▼>** key to select the required Tag identification code (Tag 0 or one out of the 20 available Tags from "A" to "S").

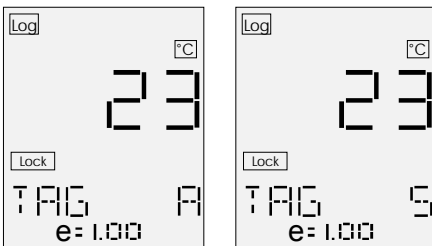

- Press the **<SEL>** key to display the value of the first memory location in the selected Tag.



- Press the **<▲>** or **<▼>** key to display the subsequent memory locations.

12 LOGGING DATA MANAGER

LogMan software allows **OSP series** users to set and prepare infrared thermometers to acquire the data organized by 'Tag'.

This software also allows to download data from Instrument on document (table) with date, time and value. You can view table, save table, print table, export table in excel-txt-html and obtain graphs. You can also manage data coping, moving on other tables.

The software manages two different files :

- Extension .LMM are models. It means you will save on disk only preference setting.
- Extension .LMD are models and contains also data. It means you will save on disk current model with all data on table.

When you open a new file a DEFAULT.LMM model will be automatically loaded.

If you prefer different preferences (for example header and footer with your company name) load model DEFAULT.LMD change data and save it.

12.1 Installation

LogMan runs on IBM PC under WINDOWS95 or NT. Minimum requirements are a 486 CPU with 8 Mb Ram and 2Mb on hard disk, color monitor and a Microsoft mouse or a compatible one.

In order to install **LogMan** for Windows, follow the below procedure:

- Place the **LogMan** disk in a 3.5" diskette drive;
- From the Windows Program Manager's File Menu, select **<RUN>**;
- Enter the filename A:setup.exe (substitute the letter A for the disk drive that contains **LogMan** diskette)
- Follow on screen instructions making sure to provide your **LogMan** directory, when prompted, with the correct path.

Once installed, in "Start" menu, the **LogMan** icon will appear it will be possible to boot it by select it as usual.

12.2 Program Architecture

LogMan has a typical Windows structure with a series of menu and toolbars that can be recalled by clicking on the name, or on the icon which represents the action the user wants to carry out.

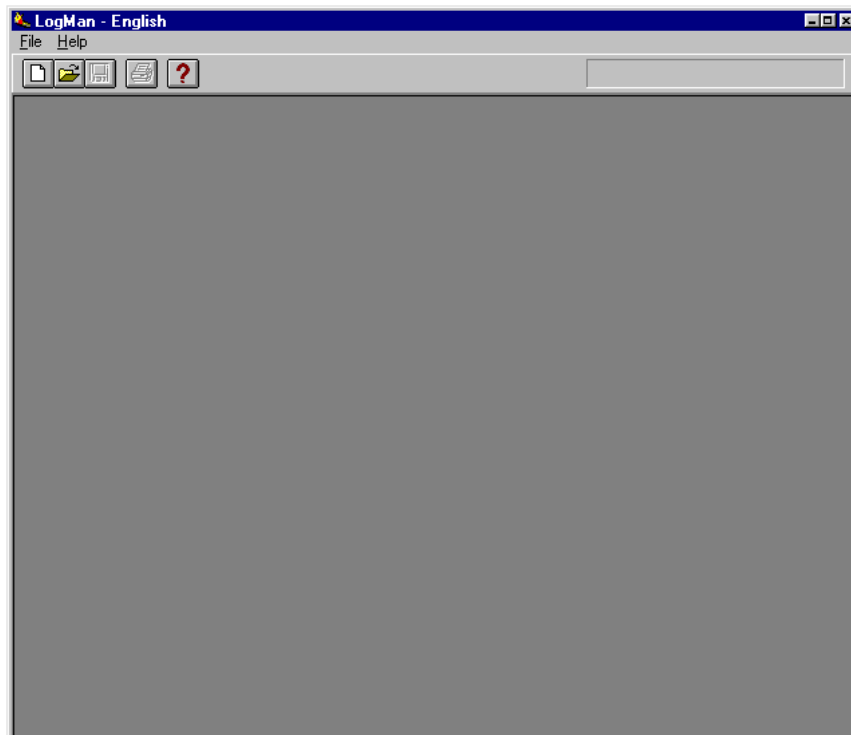

The main menu program is structured as it follows:



These menu are subdivided in:

File	New, Open, Save, Print menu.
New	Creates a new document.
Open	Opens an existing document.
Options	Set Communication port, text language and synchronize clock
Exit	Exits from Logman.
Help	Help menu.
Index	Offers you an index about topics on which you can get help.
About	Displays the version number of this application.

When a document is loaded or created, the new main menu is:



File	New, Open, Save, Print menu.
New	Creates a new document.
Open	Opens an existing document.
Save	Saves an opened document using the same file name.
Save As	Saves an opened document to a specified file name.
Export	Exports opened documents as Excel, txt or HTML file
Close	Closes an opened document.
Print setup	Selects a printer and printer connection.
Print	Prints a document.
Options	Set Communication port, text language and synchronize clock
Language	Selects language text
Port settings	Select communication port COM
Synchronize instrument	Sets IR thermometer internal clock equal to Computer
Exit	Exits from Logman.
Data	Instrument operation menu (Menu accessible only if 'Data Table Window' is active).
AutoLoad tag	Loads automatically from the instrument.
Load tag	Loads from the instrument.
Save tag	Saves preferences on the instrument.
Save as tag 0	Saves preferences on the instrument Tag 0.
Delete tag	Deletes the Tag on the instrument.
Clear all tags	Deletes all Tag on the instrument.
PC Log	Logs data from the instrument.
Sample now	Logs one datum only from the instrument.
Preferences	Set preferences.
Edit	Data operation menu (Menu accessible only if 'Data Table Window' is active).
Copy into new file	Copies a selection in to a new file.
Copy into open file	Copies a selection in to an existing file.
Move into new file	Moves a selection in a new file.
Move into open file	Moves a selection in an existing file.
Delete	Deletes selections.
Subtract	Subtracts two selections in a new file.
Window	Windows operation menu.
Tile	Tiles all active windows.
Cascade	Cascades all active windows.
Arrange Icons	Arranges all active icons.
Help	Help menu.
Index	Offers you an index to topics on which you can get help.
About	Displays the version number of this application.

12.2.1 Toolbars

Additional tool bars menu appear when the data view window or the graph view window is selected.



Fig. 11.2a: Data view toolbar

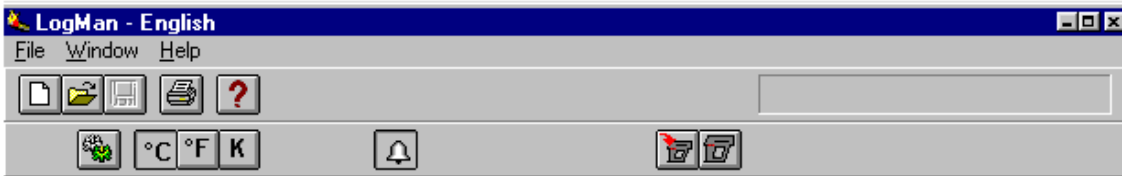

Fig. 11.2b: Graph view toolbar

The following buttons are displayed on the toolbars.



View graph on actual data window

Pressing this button a new window, containing the graph of the active data table, is displayed.



Preference dialog

On preferences menu command you can set :

Instrument

- Tag name (max 7 characters).
- Emissivity (from 0.10 to 1.00).
- Temperature scale (IPTS 68 or ITS90)
- Units (°C, °F or K).
- Decimal point (1 or 0.1).
- Alarms value and check box (on/off).
- Sampling time and total time of PC log.

Header Lines (max 10).

Footer Lines (max 10).

Print

- Top, header, left, right, bottom and footer distance in inches.
- Enable/Disable Grid and color.
- Enable/Disable Center table horizontally

Graph

- Autoscale or Lower and Upper Limits.

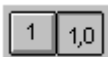

Select decimal point (0 or 1)



Select engineering units (°C, °F or K).



Enable/Disable alarms



Copy into a new file

Use this command to copy selected data onto a new file.

This command is unavailable if there are no data currently selected.



Copy into an open file

Use this command to copy selected data onto an opened file.
It will appear a list of current opened files to be selected.
This command is unavailable if there are no data currently selected.



Move into a new file

Use this command to move selected data onto a new file.
This command is unavailable if there are no data currently selected.



Move into an open file

Use this command to move selected data onto an opened file.
It will appear a list of current opened files to be selected.
This command is unavailable if there are no data currently selected.



Set instrument Tag 0 with current preferences



Sample now

Connect the unit to communication port of the computer.
Press the <**Sample now**> command to log one datum on actual document.

12.3 Quick starting

This software allows to download data from Instrument on document (table) with date, time and value.
You can view table, save table, print table, export table in excel-txt-html and obtain graph.

For example if you want to measure the temperature of the transformer model AGC 134.

- Run the command <**File New**> from the menu. The following windows will appear:

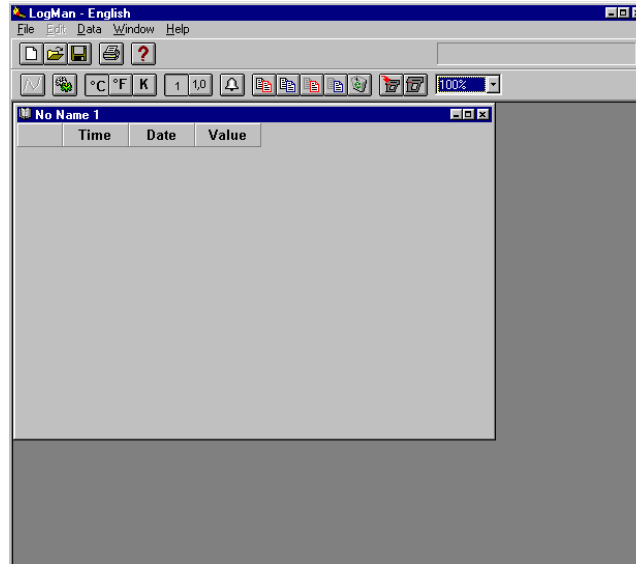

- Select the command <**Data**> from the menu and then the option <**Preference**>. Fill in preferences windows the parameters you need: For example:
 TAG name : AGC 134
 Emissivity : 0.98
 Low Alarm Level: +15 °C (you don't need it so you can set it very low)
 High Alarm Level: +30 °C.

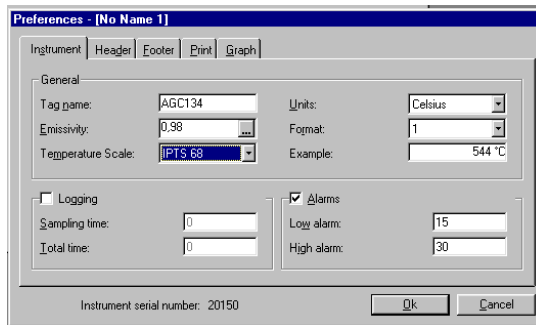

- Select **<OK>** button to save the preference setting in the PC Memory.
- From the preference menu you can also set the header and footer line as you need for later printed report.
- Save model (Save as ...) with extension .LMM.
- Now connect the instrument with the communication cable and turn it on.
- Open the file AGC.LMM (if previously closed).
- Select the **<Data>** command from the menu and then the option **<Save Tag>**. Select for example Tag A and press the **<Ok>** button.

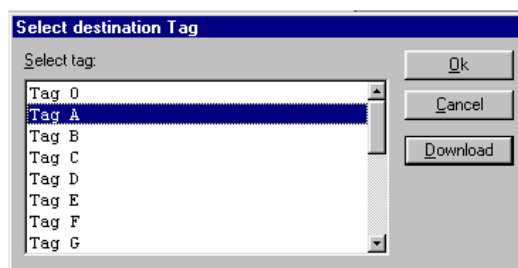

- Disconnect the unit and go on the field to take same measurements (see also cap.10 to operate in an acquisition mode).
- Start this procedure with the **OSP** switched -Off-
- Keep the **<MEM>** key pressed and, simultaneously, press the **<Trigger>** until the following indication is displayed :



- Press the **<▲>** or **<▼>** key to select the Tag A identification code.



- Press the **<SEL>** key to display the number of memory locations still available.



Data can be recorded in the selected Tag in manual or automatic mode. About the acquisition mode and setting of time acquisition, refer to par. 9.5.

- If necessary, press the **<SEL>** key to obtain the page that allows the clearing of the previous memory stored data in the Tag A:



- Press the <ENTER> key to clear the memory content and to obtain the following message that require confirmation :



- Press the <ENTER> key to confirm the cancellation request and to obtain the following message :



- Press the <SEL> key to obtain the following page indicating the identification code (or name) assigned to the active Tag (i.e. ACG 134).

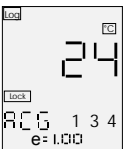

- Press the <SEL> key to review the pages relevant with -HAL- and -LAL- alarm settings. To modify the alarm level in the data acquisition mode see the paragraph 10.2.

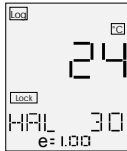

- Press the <MEM> key to acquire one measurement value.
- Once the acquisition completed, you can switch OSP off and go back to the computer. Reconnect the unit to the PC and open the file AGC.LMM (if previously closed).
- Run the command <Autoload Tag> From the <Data> menu (the program will search inside the instrument tag AGC 134 and will download data).

	Time	Date	Value
1	10,39,20	27/01/98	22 °C
2	10,42,41	27/01/98	21 °C
3	10,42,42	27/01/98	21 °C
4	10,42,42	27/01/98	21 °C
5	10,42,42	27/01/98	21 °C
6	10,42,42	27/01/98	21 °C
7	10,42,42	27/01/98	21 °C
8	10,42,43	27/01/98	20 °C

Minimum 20,0 Average 20,8 Maximum 21,8

- Press the  button to display the data graph window containing the graph of the active data table.

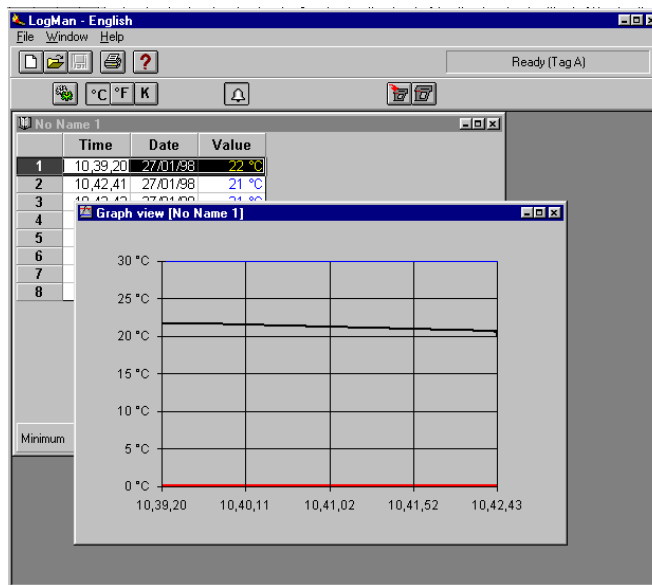

Now you can save data on disk using name with extension LMD (for example TODAY.LMM).

13 OPTIONS & ACCESSORIES

13.1 Printer operations

- Connect a compatible printer to **OSP** and switch the thermometer on.



- Press the <MEM> key to obtain the following indication:

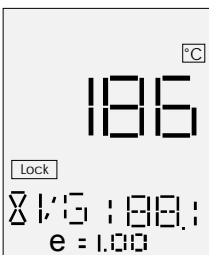

- Press the <ENT> key to print the Date, Time and measured value as follows:

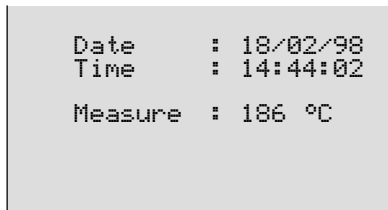

13.2 Sighting telescope system

Item	Q.ty	Part n.°	Description
1	2	EE010015	fastening screws for guide
2	1	EE280169	guide
3	2	EE280179	mounting rings
4	1	EE280181	telescope
5	1	EE280198	filter ring
6	1	EE360053	filter HT
7	1	EE370133	O-ring

Installation of the telescope :

- Remove with a cut screwdriver the nut protection caps placed on the upper part of the instrument.
- Place the guide on the upper part of the pyrometer, taking care of orientating it so that it leans entirely on the back of the instrument.
- Fasten the screws in order to make the guide integral with the pyrometer.
- Place the mounting rings on the guide, in order to cling them to the side edges. Let each ring slide along the guide until each catch is housed in the respective slot. Fasten firmly each fastening screw with a coin or a screwdriver.
- Separate the upper and the lower half of each mounting ring by removing the two screws, using the enclosed hexagonal wrench.
- Put the telescope in the supporting framework formed by the lower halves of the mounting rings and place the extremity with the widest diameter turned towards the target.
- Rotate the telescope into the mounting rings, in order to bring the elevation adjustment (UP) high. Fasten the screws, avoiding to make an excessive clamping.

Alignment of the telescope :

- Make the pyrometer integral with a support.

- 2 Remove the elevation and the windage adjustment caps.
- 3 Switch on the two pinpointing lasers and aim them to a target placed at a distance equal to the working distance.
- 4 The aiming must be carried out by keeping the eyepiece at a distance of about 80 cm from the eye.
- 5 Operating on the two adjustments (elevation and windage), place the center of the reticule in connection with the center of the axis joining the two spot lasers. The minimum suggested working distance is 5 meters, shorter working distance can cause alignment problems.
- 6 In this way the telescope is aligned to operate at the working distance; a variation in the working distance requires a new alignment of the telescope.

Filter installation

- 1 Filter use is suggested in viewing targets with temperature higher than 1000°C
- 2 Install the filter ring on the front side of the telescope lightly pushing the component

CAUTION

NEVER LOOK AT THE SUN THROUGH THE TELESCOPE: THE CONCENTRATION OF STRONG SOLAR RAYS CAN CAUSE SERIOUS EYE DAMAGE.

NEVER LOOK AT TARGET WITH TEMPERATURE HIGHER THAN 1000°C WITHOUT THE TELESCOPE PROTECTION FILTER. CONCENTRATION OF STRONG VISIBLE - IR RADIATION CAN CAUSE EYE DAMAGE

13.3 Red Point pinpointing system

Item	Q.ty	Part n.°	Description
1	2	EE010015	fastening screws for the guide
2	1	EE280169	guide
3	1	EE280180	N°1 red point sight device N°2 mounting rings N°1 polarize filter N°1 lens Hood extension
4	1	EE360055	filter for T > 1300°C
5	1	EE360057	filter for T from 1000 to 1300°C
6	1	EE370127	O-ring/O-ring

Installation of the sighting device :

1. Remove with a cut screwdriver the nut protection caps placed on the upper part of the instrument.
2. Place the guide on the upper part of the pyrometer, taking care of orientating it so that it leans entirely on the back of the instrument.
3. Fasten the screws in order to make the guide integral with the pyrometer.
4. Place the mounting rings on the guide, in order to cling them to the side edges. Let each ring slide along the guide until each catch is housed in the respective slot. Fasten firmly each fastening screw with a coin or a screwdriver.
5. Separate the upper and the lower half of each mounting ring by removing the two screws, using the enclosed hexagonal wrench.
6. Put the sighting device in the supporting framework formed by the lower halves of the mounting rings, so that the rheostat hand grip is situated on the left side of the pyrometer, with respect to the aiming direction.
7. Rotate the sighting device into the mounting rings, in order to bring the elevation adjustment (UP) high. Fasten the screws, avoiding to make an excessive clamping.

Alignment of the sighting device :

1. Make the pyrometer integral with a support.
2. Activate the illuminated red point by turning the rheostat hand grip clockwise to increase the brightness or in an counter-clockwise direction to reduce it. The position "1" indicates the minimum brightness and the position "7", the maximum one.
3. The aiming must be carried out by keeping the eyepiece at a distance of at least 7 cm from the eye.
4. Remove the elevation and the windage adjustment caps.
5. Switch on the two pinpointing lasers and aim them to a target placed at a distance equal to the working distance. The minimum suggested working distance is 5 meters, shorter working distances can cause alignment problems
6. Operating on the two adjustments (elevation and windage), place the illuminated red dot in connection with the centre of the axis joining the two spot lasers.
7. In this way the sighting device is aligned to operate at the working distance ; a variation in the working distance requires a new alignment of the sighting device.

Filter installation

- 1 Select the filter depending on the working temperature
- 2 Insert the selected filter in the internal side of the polarized filter mount
- 3 Place the O-ring over the filter to lock it

- 4 Screw up the polarized filter with the inserted optical filter placed on the front side of the sighting device

CAUTION

IF YOUR OSP UNIT IS EQUIPPED WITH TELESCOPE OR "RED POINT" PINPOINTING SYSTEM, NEVER AIM OSP DIRECTLY AT THE SUN, AS EYE DAMAGE COULD RESULT.

14 APPLICATION NOTES

14.1 Infrared energy

Each body, at temperatures above the absolute zero (-273°C or 0K), emits energy in the form of electromagnetic radiation.

As the temperature of the body rises, the intensity of this infrared energy increases.

The temperature of this particular body can therefore be determined by measuring the intensity of this infrared energy.

An equipment used to measure the temperature with this method is called "infrared thermometer" or a "non-contact thermometer" since the thermometer is not required to be in contact with the body in order to measure its temperature.

14.2 Applications

The temperature measurement of liquids or gases is well accomplished using a thermoelectric sensor thanks to the good thermal exchange between the sensor and the fluid.

When solid objects are to be measured it is difficult to obtain a good thermal exchange and the possibility of making an additional error should be kept into consideration.

Temperature measurements with direct contact are often impossible to be carried out when the target is moving or is connected to dangerous electrical sources or when, for any other reason, it is impossible or difficult to touch it.

14.3 Emissivity

The infrared energy emitted by a body differs according to the composition of the body and to the physical condition of the surface.

Non-contact thermometers are calibrated using a blackbody source (made with material that absorbs energy at all wavelengths) as a reference standard.

However, to obtain the reading of the true temperature, it is necessary to compensate the thermometer for the actual emissivity of the object to be measured.

$$\text{Emissivity} = \frac{\text{Surface Radiation}}{\text{Blackbody Radiation}}$$

All **OSP** infrared thermometers are equipped with an emissivity adjustment from 0.10 to 1.00.

The emissivity values relevant to different materials and surface conditions are detailed in "How to determine an object emissivity" in Appendix A2 of this manual.

The values from the above tables are reference values only: emissivity can in fact be slightly higher with a higher oxidation of the material .

14.4 Reflected energy compensation

The radiation perceived from the thermometer is the one emitted by the target plus the radiation reflected by the surface of the object itself.

To obtain more accurate readings, particularly for measurements of low emissivity temperature objects, the energy reflected from the target should be considered; that energy changes according to the temperature of the surrounding environment.

A typical example of that principle of operation comes from re-heating furnaces, where the temperature of the vault is considerably higher than the target temperature.

OSP thermometers provide an auxiliary function "TAM" to compensate for the ambient temperature.

When the average value of the ambient temperature is set, the microprocessor processes a correction algorithm and then displays the real temperature value of the target (see par. 9.7).

As an example, the error occurring when no auxiliary function "TAM", to compensate for the ambient temperature, is enabled can reach 20°C when measuring a target at 100°C with the ambient temperature of 150°C.

15 DIGITAL INTERFACE

The **OSP** portable IR thermometer can be equipped with a digital interface.

The interface circuit is essentially based on the serial communication interface subsystem (SCI) on the chip of the microcontroller. The output voltage levels are TTL at 0 to +5 V.

An optional adapter to convert the voltage level from 0 to +5 V to RS232 standard levels can be supplied. This adapter is required to interface **OSP** with a Personal Computer.

15.1 Digital output wiring practice

The wiring to digital output signals is made through a mini DIN connector mounted on the lower end of the case. The pertinent connections are indicated below :

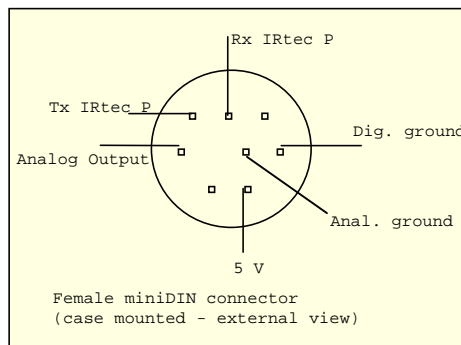

For easy interconnections a miniDIN connector with cable (cat. EE420123) can be supplied on request. The color codes of the conductors can change with different suppliers; please check before using.

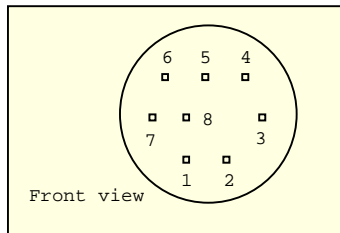

	<u>LINDY</u>	<u>CINCH</u>
pin 1 :	brown	black
pin 2 :	red	green
pin 3 :	green	blue
pin 4 :	gray	gray
pin 5 :	purple	yellow
pin 6 :	blue	white
pin 7 :	orange	red
pin 8 :	yellow	brown

15.2 TTL to RS 232 adapter

The cat. BB530001 TTL to RS232 adapter consists of a cable to which are connected a male mini DIN connector (for **OSP**) and a DB25 connector, that contains the electrical circuitry (for the PC).

The basic circuit and connections are as follows:

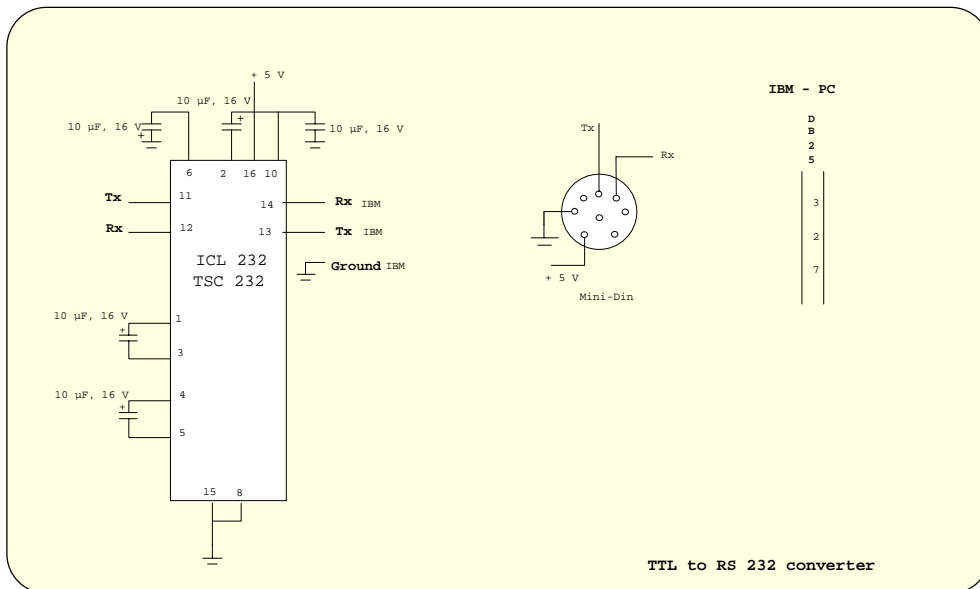

15.3 Communication protocol

The exchange of information when a **OSP** is interconnected with a PC is as it follows.
 Serial Interface of PC has to be set to 9600 Baud, 8 bit and No parity.

15.3.1 Computer data request from OSP to PC

Computer

OSP

Tx IDNAME	→	Rx IDNAME	Proceed if the name is acknowledged
Rx IDNAME	←	Tx IDNAME	If not, do not answer
Tx Instruction	→	Rx Instruction	
Rx Instruction	←	Tx Instruction	
Tx char	→	Rx char	
Rx DATA 1	←	Tx DATA 1	
Tx char	→	Rx char	
Rx DATA 2	←	Tx DATA 2	
Tx char	→	Rx char	
Rx DATA 3	←	Tx DATA 3	
Tx char	→	Rx char	
Rx DATA 4	←	Tx DATA 4	
Tx CHKSUM	→	Rx char	
Rx CHKSUM	←	Tx CHKSUM	

IDNAME, Instruction, DATA 1, DATA 2, DATA 3, DATA 4 and CHKSUM are 8-bit values (1 byte)
 Tx CHKSUM = DATA 1+DATA 2+DATA 3+DATA 4 .AND. FF
 Rx CHKSUM = DATA 1+DATA 2+DATA 3+DATA 4 .AND. FF

The above is useful to verify correct received data.
 The minimum time-out of OSP is 3 seconds.
 IDNAME is set to 1.

Reading values

\$00 - Pyrometer measure ----- RX

DATA1 STATUS
DATA2 -
DATA3 VALUE (H)
DATA4 VALUE (L)

IF STATUS=0 MEASURE = SIGNED INTEGER (VALUE) / 10
IF STATUS=2 MEASURE = ERROR RJ
IF STATUS=10 MEASURE = OFL
IF STATUS=11 MEASURE = UFL

\$01 - Emissivity ----- RX

DATA1 -
DATA2 -
DATA3 -
DATA4 VALUE

EMISSION = VALUE / 100

\$03 - Max input value ----- RX

DATA1 -
DATA2 -
DATA3 VALUE (H)
DATA4 VALUE (L)

MAX = SIGNED INTEGER (VALUE) / 10

\$04 - Min input value ----- RX

DATA1 -
DATA2 -
DATA3 VALUE (H)
DATA4 VALUE (L)

MIN = SIGNED INTEGER (VALUE) / 10

\$05 - Average input value ----- RX

DATA1 -
DATA2 -
DATA3 VALUE (H)
DATA4 VALUE (L)

AVERAGE = SIGNED INTEGER (VALUE) / 10

\$06 - Tag ID,Eng.unit,Tc type,IPTS ----- RX

DATA1 Tag ID (0=Tag0, 1=TagA, 2=TagB,.....,19=TagS)
DATA2 Eng.unit (1=°C - 2=K - 3=°F)
DATA3 Tc type (0=Tc K - 1=Tc S)
DATA4 IPTS (0=68 - 1=90)

\$07 - Tc measure ----- RX

DATA1 STATUS
DATA2 -
DATA3 VALUE (H)
DATA4 VALUE (L)

IF STATUS=0 MEASURE = SIGNED INTEGER (VALUE) / 10
IF STATUS=1 MEASURE = ERROR RJ
IF STATUS=2 MEASURE = TC OFF
IF STATUS=10 MEASURE = OPTC

\$08 - HAL Setpoint ----- RX

DATA1 -
DATA2 -
DATA3 VALUE (H)
DATA4 VALUE (L)

HAL = SIGNED INTEGER (VALUE)
IF HAL=3001 THEN HAL=OFF

\$09 - LAL Setpoint ----- RX

DATA1 -
DATA2 -
DATA3 VALUE (H)
DATA4 VALUE (L)

LAL = SIGNED INTEGER (VALUE)
IF LAL=3001 THEN LAL=OFF

\$0B - First 4 chars tag description ----- RX

DATA1 'X' (ASCII CODE)
DATA2 'X' (ASCII CODE)
DATA3 'X' (ASCII CODE)

DATA4 'X' (ASCII CODE)

\$0C - Last 4 chars tag description ----- RX

DATA1 'X' (ASCII CODE)
DATA2 'X' (ASCII CODE)
DATA3 'X' (ASCII CODE)
DATA4 -

\$0D - Alarm status ----- RX

DATA1 LAL Status (0=No alarm - 1=Alarm active)
DATA1 HAL Status (0=No alarm - 1=Alarm active)
DATA1 -
DATA1 -

\$1C - Firmware version ----- RX

DATA1 'X' (ASCII CODE)
DATA2 'X' (ASCII CODE)
DATA3 'X' (ASCII CODE)
DATA4 'X' (ASCII CODE)

15.3.2 Computer data setting from PC to OSP

Computer

OSP

Tx IDNAME	→	Rx IDNAME	Proceed if the name is acknowledged
Rx IDNAME	←	Tx IDNAME	If not, do not answer
Tx Instruction	→	Rx Instruction	
Rx Instruction	←	Tx Instruction	
Tx DATA 1	→	Rx DATA 1	
Rx char	←	Tx char	
Tx DATA 2	→	Rx DATA 2	
Rx char	←	Tx char	
Tx DATA 3	→	Rx DATA 3	
Rx char	←	Tx char	
Tx DATA 4	→	Rx DATA 4	
Rx char	←	Tx char	
Tx CHKSUM	→	Rx char	
Rx char	←	Tx char	

IDNAME, Instruction, DATA 1, DATA 2, DATA 3, DATA 4 and CHKSUM are 8-bit values (1 byte).
CHKSUM = DATA 1+DATA 2+DATA 3+DATA 4 .AND. FF

The above is useful to verify correct received data.
The minimum time-out of **OSP** is 3 seconds.
IDNAME is set to 1.

Writing values

\$80 - Emissivity ----- TX

DATA1 0
DATA2 0
DATA3 0
DATA4 VALUE

VALUE = EMISSIVITY X 100

\$82 - Tc type ----- TX

DATA1 0
DATA2 Tc type (0=Tc K - 1=Tc S)
DATA3 0
DATA4 0

\$84 - HAL Setpoint ----- TX

DATA1 VALUE (HH)
DATA2 VALUE (H)
DATA3 VALUE (L)

DATA4 VALUE (LL)

SIGNED LONG VALUE = ALARM HI

\$85 - LAL Setpoint----- TX

DATA1 VALUE (HH)
DATA2 VALUE (H)
DATA3 VALUE (L)
DATA4 VALUE (LL)

SIGNED LONG VALUE = ALARM LO

\$86 - Tag ID selection----- TX

DATA1 Tag ID (0=Tag0, 1=TagA, 2=TagB,....., 19=TagS)
DATA2 -
DATA3 -
DATA4 -

\$87 - Tag description----- TX

DATA1 Char position (0=7)
DATA2 'X' (ASCII CODE)
DATA3 -
DATA4 -

15.3.3 Communication programs

In this paragraph are illustrated two examples of communication programs between the **OSP** and an IBM or IBM compatible PC.

Example A:

Data transfer from OSP to PC

Connect **OSP** through adapter BB530001 (TTL-RS232 converter), to personal computer communication port COM1. You will read temperature value.

Example B:

PC instructions to OSP

Connect **OSP** through adapter BB530001 (TTL-RS232 converter), to personal computer communication port COM1. You will set emissivity to 0,80.

Example A:

```
1Ø CHAR = Ø
2Ø IDNAME = 1
3Ø INSTRUCTION = 0
35 OPEN "COM1: 96ØØ, N,8,1,CD,CS,DS,RS" FOR RANDOM AS # 1
4Ø PRINT #1, CHR$ (IDNAME);:REM TRANSMIT IDNAME TO OSP
5Ø WHILE LOC (1) = Ø: WEND: REM WAIT RECEIVING IDNAME FROM OSP
6Ø IDNAME = ASC (INPUT$ (1, 1)): REM READ RECEIVED IDNAME FROM OSP
7Ø PRINT #1, CHR$ (INSTRUCTION);
8Ø WHILE LOC (1) = Ø: WEND
9Ø INSTRUCTION = ASC (INPUT$ (1, 1))
1ØØ PRINT #1, CHR$ (CHAR);
11Ø WHILE LOC (1) = Ø: WEND
12Ø DATA 1 = ASC (INPUT$ (1, 1))
13Ø PRINT #1, CHR$ (CHAR);
14Ø WHILE LOC (1) = Ø: WEND
15Ø DATA 2 = ASC (INPUT$ (1, 1))
16Ø PRINT #1, CHR$ (CHAR);
17Ø WHILE LOC (1) = Ø: WEND
18Ø DATA 3 = ASC (INPUT$ (1, 1))
19Ø PRINT #1, CHR$ (CHAR);
2ØØ WHILE LOC (1) = Ø: WEND
21Ø DATA 4 = ASC (INPUT$ (1, 1))
22Ø PRINT #1, CHR$ (CHAR);
231Ø WHILE LOC (1) = Ø: WEND
24Ø CHKSUM = ASC (INPUT$ (1, 1))
25Ø IF CHKSUM <> ((DATA1 + DATA2 + DATA3 + DATA4) AND &HFF) THEN PRINT "Error": END
26Ø VALUE = DATA3 * 256 + DATA4
27Ø IF VALUE > 32767 THEN VALUE =VALUE - 65536: REM 2'S COMPLEMENT
```

```
28Ø PRINT "VALUE: " ; VALUE / 1Ø
29Ø END
```

Example B:

```
1Ø CHAR = Ø
2Ø IDNAME = 1
3Ø INSTRUCTION = &H80
4Ø VALUE = 80
5Ø VALUE$ = HEX$ (VALUE/100)
55 WHILE LEN (VALUE$)<4: VALUE$ ="Ø"+VALUE$: WEND
6Ø IF LEN (VALUE$) > 4 THEN VALUE$ =RIGHT$ (VALUE$,4)
65 DATA1 = VAL ("&H" + LEFT$ (VALUE$, 2))
7Ø DATA2 = VAL ("&H" +RIGHT$ (VALUE$, 2))
75 DATA3 = Ø
8Ø DATA4 = Ø
9Ø CHKSUM = (DATA1 + DATA2 + DATA3 + DATA4) AND &H7F
1ØØ REM MEMORY RELEASE PREVIOUS 4.xx1 (Example 4.ØØØ, 4.2ØØ) MUST USE
11Ø REM NEXT LINE INSTEAD LINE 9Ø OR PROGRAM DOES'NT WORK
12Ø REM CHKSUM =(DATA1 + DATA2 + DATA3 + DATA4) AND &HFF
13Ø OPEN "COM1: 96ØØ,N,8,1,CD,CS,DS,RS" FOR RANDOM AS #1
14Ø PRINT #1, CHR$ (IDNAME) ; : REM TRANSMIT IDNAME TO OSP
15Ø WHILE LOC (1) = Ø: WEND: REM WAIT RECEIVING IDNAME FROM OSP
16Ø IDNAME = ASC (INPUT$ (1 , 1)): REM READ RECEIVED IDNAME FROM OSP
17Ø PRINT #1, CHR$ (INSTRUCTION) ;
18Ø WHILE LOC (1) = Ø : WEND
19Ø INSTRUCTION = ASC (INPUT$ (1 , 1))
2ØØ PRINT #1, CHR$ (DATA1) ;
21Ø WHILE LOC (1) = Ø : WEND
22Ø CHAR = ASC (INPUT$ (1 , 1))
23Ø PRINT #1, CHR$ (DATA2) ;
24Ø WHILE LOC (1) = Ø : WEND
25Ø CHAR = ASC (INPUT$ (1 , 1))
26Ø PRINT #1, CHR$ (DATA3) ;
27Ø WHILE LOC (1) = Ø : WEND
28Ø CHAR = ASC (INPUT$ (1 , 1))
29Ø PRINT #1, CHR$ (DATA4) ;
3ØØ WHILE LOC (1) = Ø : WEND
31Ø CHAR = ASC (INPUT$ (1 , 1))
32Ø PRINT #1, CHR$ (CHKSUM) ;
33Ø WHILE LOC (1) = Ø : WEND
34Ø CHAR = ASC (INPUT$ (1 , 1))
35Ø PRINT "Transmitted."
39Ø END
```

16 MAINTENANCE

Each **OSP** portable infrared thermometer has been factory tested and calibrated before shipment. The calibration should be verified and re-adjusted if the instrument shows an error exceeding the declared specifications or when a critical active or passive component is replaced (either at the component level or at the board level). **OMEGA** engineers will give prompt support for any request of assistance.

16.1 Faulty operating conditions

During the start-up and measuring modes, faulty conditions of the instrument will be announced with coded messages. If the faulty condition is critical for the application, it is recommended to re-start the pertinent set-up procedure. All errors which cannot be recovered without the user's knowledge, result in some system action to inform the operator via message and where possible to restore the system. Restarting the instrument from -Power ON- may clear the error, but generally such messages are caused by hardware or software faults, which require the user's action.

Display	Error Type	Solution
Err 1	Internal EEPROM memory error	Contact technical support
Err 2	IR sensor reading error	Verify ambient temperature (from -5 to +55°C)
Err 3	Calibration data error	Recalibrate unit
OTC	No sensor connected at Tc input	Connect sensor
RJer	Cold-junction sensor reading error	Verify ambient temperature (from -5 to +55°C)

16.2 Storage

If the instrument has been left unused for a long time, it is recommended to remove the batteries. Store the instrument in the original package, at a temperature from -30°C to +60°C, with R.H. less than 90%. If the instrument has been unused for a month check the battery voltage, and charge the Ni-MH batteries for at least 12 hours with the unit switched off.

APPENDIX

A1 How to determine an object emissivity

Emissivity is the measure of an object ability to absorb, transmit, and emit infrared energy. It can have a value from 0 (shiny mirror) to 1.0 (blackbody). If a value of emissivity higher than the actual one is set, the output will read low, provided that the target temperature is above the ambient one. For example, if 0.95 is set in and the actual emissivity is 0.9, the reading will be lower than the true temperature when the target temperature is above the ambient one.

The emissivity can be determined by one of the following methods, in order of preference:

1. Determine the actual temperature of the material using a sensor such as a RTD, thermocouple or another suitable method. Next, measure the object temperature and adjust the emissivity setting until the correct value is reached. This is the correct emissivity for the measured material.
2. For relatively low temperature objects (up to 260°C or 500°F, place a piece of tape, such as a masking, on the object. Make sure the tape is large enough to cover the field of view. Next, measure the tape temperature using an emissivity setting of 0.95. Finally, measure an adjacent area on the object and adjust the emissivity setting until the same temperature is reached. This is the correct emissivity for the measured material.
3. If a portion of the surface of the object can be coated, use a flat black paint, which will have an emissivity of about 0.98. Next, measure the painted area using an emissivity setting of 0.98. Finally, measure an adjacent area on the object and adjust the emissivity setting until the same temperature is reached. This is the correct emissivity for the measured material.

A1.1 Typical Emissivity Values

The following table provides a brief reference guide to determine emissivity and can be used when one of the above methods is not practical. Emissivity values shown in the table below are only approximate, since several parameters may effect the emissivity of an object. These include the following ones:

1. Temperature
2. Angle of measurement
3. Geometry (plane, concave, convex, etc.)
4. Thickness
5. Surface quality (polished, rough, oxidized, sandblasted)
6. Spectral region of measurement
7. Transmissivity (i.e., thin film plastics)

A1.2 Metals - Typical Emissivity Values

	1.0 μm	1.6 μm	5.1 μm	8-14 μm
Aluminum				
Non-Oxidized	0.1-0.2	0.02-0.2	0.02-0.2	0.02-0.1
Oxidized	0.4	0.4	0.2-0.4	0.2-0.4
Alloy A 3003				
Oxidized	—	0.4	0.4	0.3
Roughened	0.2-0.8	0.2-0.6	0.1-0.4	0.1-0.3
Polished	0.1-0.2	0.02-0.1	0.02-0.1	0.02-0.1
Brass				
Polished	0.8-0.95	0.01-0.05	0.01-0.05	0.01-0.05
Burnished	—	—	0.3	0.3
Oxidized	0.6	0.6	0.5	0.5
Carbon				
Non-oxidized	0.8-0.95	0.8-0.9	0.8-0.9	0.8-0.9
Graphite	0.8-0.9	0.8-0.9	0.7-0.9	0.7-0.8
Chromium	0.4	0.4	0.03-0.3	0.02-0.2
Copper				
Polished	0.05	0.03	0.03	0-03
Roughened	0.05-0.2	0.05-0.2	0.05-0.15	0.05-0.1
Oxidized	0.2-0.8	0.2-0.9	0.5-0.8	0.4-0.8
Gold	0.3	0.01-0.1	0.01-0.1	0.01-0.1
Haynes Alloy	0.5-0.9	0.6-0.9	0.3-0.8	0.3-0.8
Inconel				
Oxidized	0.4-0.9	0.6-0.9	0.6-0.9	0.7-0.95
Sandblasted	0.3-0.4	0.3-0.6	0.3-0.6	0.3-0.6
Electro-polished	0.2-0.5	0.25	0.15	0.15
Iron				
Oxidized	0.4-0.8	0.5-0.9	0.6-0.9	0.5-0.9
Non-oxidized	0.35	0.1-0.3	0.05-0.25	0.05-0.2
Rusted	—	0.6-0.9	0.5-0.8	0.5-0.7
Molten	0.35	0.4-0.6	—	—
Iron Cast				
Oxidized	0.7-0.9	0.7-0.9	0.65-0.95	0.6-0.95
Non-oxidized	0.35	0.3	0.25	0.2
Molten	0.35	0.3-0.4	0.2-0.3	0.2-0.3
Iron Wrought				
Dull	0.9	0.9	0.9	0.9
Lead				
Polished	0.35	0.05-0.2	0.05-0.2	0.05-0.1
Rough	0.65	0.6	0.4	0-4
Oxidized	—	0.3-0.7	0.2-0.6	0.2-0.6
Magnesium	0.3-0.8	0.05-0.3	0.03-0.15	0.02-0.1
Mercury	—	0.05-0.15	0.05-0.15	0.05-0.15
Molybdenum				
Oxidized	0.5-0.9	0.4-0.9	0.3-0.7	0.2-0.6
Non-oxidized	0.25-0.35	0.1-0.3	0.1-0.15	0.1
Monel (Ni-Cu)	0.3	0.2-0.6	0.1-0.5	0.1-0.14
Nickel				
Oxidized	0.8-0.9	0.4-0.7	0.3-0.6	0.2-0.5
Electrolytic	0.2-0.4	0.1-0.3	0.1-0.15	0.05-0.15
Platinum				
Black	—	0.95	0.9	0.9
Silver	0.04	0.02	0.02	0.02
Steel				
Cold-Rolled	0.8-0.9	0.8-0.9	0.8-0.9	0.7-0.9
Ground Sheet	—	—	0.5-0.7	0.4-0.6
Polished Sheet	0.35	0.25	0.15	0.1
Molten	0.35	0.25-0.4	0.1-0.2	—
Oxidized	0.8-0.9	0.8-0.9	0.7-0.9	0.7-0.9
Stainless	0.35	0.2-0.9	0.15-0.8	0.1-0.8
Tin (Non-oxidized)	0.25	0.1-0.3	0.05	0.05
Titanium				
Polished	0.5-0.75	0.3-0.5	0.1-0.3	0.05-0.2
Oxidized	—	0.6-0.8	0.5-0.7	0.5-0.6

	1.0 μm	1.6 μm	5.1 μm	8-14 μm
Tungsten		0.1-0.6	0.05-0.5	0.03
Polished	0.35-0.4	0.1-0.3	0.05-0.25	0.03-0.1
Zinc				
Oxidized	0.6	0.15	0.1	0.1
Polished	0.5	0.05	0.03	0.02

A1.3 Non-metals - Typical Emissivity Values

	1.0 μm	1.6 μm	5.1 μm	8-14 μm
Asbestos	0.9	0.9	0.95	0.95
Asphalt	—	0.95	0.95	0.95
Basalt	—	0.7	0.7	0.7
Carborundum	—	0.9	0.9	0.9
Ceramic	0.4	0.8-0.95	0.95	0.95
Clay	—	0.8-0.95	0.95	0.95
Concrete	0.65	0.9	0.95	0.95
Cloth	—	0.95	0.95	0.95
Glass				
Plate	—	0.98	0.85	0.85
"Gob"	—	0.9	—	—
Gravel	—	0.95	0.95	0.95
Gypsum	—	0.4-0.97	0.8-0.95	0.8-0.95
Ice	—	—	0.98	0.98
Limestone	—	0.4-0.98	0.98	0.98
Paint	—	—	0.9-0.95	0.9-0.95
Paper (any color)	—	0.95	0.95	0.95
Plastic (opaque, over 20 mils)	—	0.95	0.95	0.95
Rubber	—	0.9	0.9	0.95
Sand	—	0.9	0.9	0.9
Snow	—	0.9	0.9	0.9
Soil	—	—	0.9-0.98	0.9-0.98
Water	—	—	0.93	0.93
Wood, Natural	—	0.9-0.95	0.9-0.95	0.9-0.95

To optimize surface temperature measurements consider the following guidelines:

1. Determine the object emissivity using the suitable instrument for measurement.
2. Avoid reflections by shielding the object from surrounding high temperature sources.
3. For higher temperature objects use shorter wavelength instruments, whenever any overlap occurs.
4. For semi-transparent materials such as plastic films and glasses, assure that the background is uniform and lower in temperature than the object.
5. Mount the sensor perpendicularly to the surface whenever the emissivity is less than 0.9. In any case, do not exceed angles more than 30 degrees from incidence.

A

Acquisition by dedicated Tags; 32
 Acquisition settings; 28
 Alarm settings; 23
 Ambient Temperature Compensation (TAM); 29
 Analog Output; 10
 Analogue input Warnings & Cautions; 18
 APPLICATION NOTES; 45
 Applications; 45
 Automatic Emissivity Setting; 26

B

Battery charger; 14
 Battery level of charge; 31
 Buzzer On/Off; 29

C

Calculated Measurements; 11
 Case; 11
 Communication programs; 50
 Communication protocol; 47
 Computer data request from OSP to PC; 47
 Computer data setting from PC to OSP; 49
 CONFIGURATION; 27
 Continuous acquisition; 32

D

Danger and Certification Labels; 18
 DATA ACQUISITION OPERATIVE MODE; 32
 Date & Real Time clock setting; 28
 Decimal point selection; 29
 Digital Interface; 10
 Digital interface; 14; 46
 Digital output wiring practice; 46
 Display; 10; 14

E

Emissivity; 45

F

Faulty operating conditions; 52
 Firmware; 14
 Firmware revision number; 30
 FUNCTIONAL DESCRIPTION; 13

G

General; 9
 GENERAL DESCRIPTION; 6
 GENERAL FEATURES; 9

H

Hold; 21
 How to determine an object emissivity; 54
 How to maximize the life span of the battery; 17
 How to operate in data acquisition mode; 32
 How to Operate the instrument; 20

I

Infrared energy; 45
 Instrument codes; 7
 Instrument serial number; 30
 INTRODUCTORY NOTE; 3

K

Keyboard; 10; 13

L

Laser Sight Warnings & Cautions; 18
 Laser Sighting; 21
 Logging Data Manager; 11
 LOGGING DATA MANAGER; 35
 Logging Mode; 11
 LogMan
 Program architecture; 35
 LogMan
 Installation; 35
 Quick starting; 38
 Toolbars; 37

M

MAINTENANCE; 52
 Metals - Typical Emissivity Values; 55
 Microcontroller; 14
 Minimum, maximum and difference indication; 25

N

Non-metals - Typical Emissivity Values; 56

O

OPERATIONS; 20
 Optical System; 9
 OPTIONS & ACCESSORIES; 42

P

PHYSICAL DESCRIPTION; 12
 Power supply; 13
 POWER SUPPLY; 17
 Power supply from main line; 17
 Power supply with alkaline batteries; 17
 PRE-OPERATIONAL CHECK; 16
 Printer operations; 42

Q

Quick Start; 20

R

Recall stored data; 34
 Rechargeable batteries; 17
 Red Point pinpointing system; 43
 Reflected energy compensation; 45

S

SAFETY WARNINGS; 18
Self calibration; 10
Sighting telescope system; 42
Specifications; 8
Storage; 52

T

TABLE OF CONTENTS; 4
Taking measurements; 9
Target dimensions at different distances; 8
Target pinpointing; 9
Technical Unit selection; 27
Temperature Scale selection; 27

Thermocouple input; 24
Thermocouple Input; 10
Thermocouple input enabled; 27
TTL to RS 232 adaptor; 46

U

UNPACKING; 15
Unstable temperature measurement; 22

W

Warnings and Cautions; 18
Weight; 22
Working band; 22

WARRANTY/DISCLAIMER

OMEGA ENGINEERING, INC. warrants this unit to be free of defects in materials and workmanship for a period of **13 months** from date of purchase. OMEGA Warranty adds an additional one (1) month grace period to the normal **one (1) year product warranty** to cover handling and shipping time. This ensures that OMEGA's customers receive maximum coverage on each product.

If the unit should malfunction, it must be returned to the factory for evaluation. OMEGA's Customer Service Department will issue an Authorized Return (AR) number immediately upon phone or written request. Upon examination by OMEGA, if the unit is found to be defective it will be repaired or replaced at no charge. OMEGA's WARRANTY does not apply to defects resulting from any action of the purchaser, including but not limited to mishandling, improper interfacing, operation outside of design limits, improper repair, or unauthorized modification. This WARRANTY is VOID if the unit shows evidence of having been tampered with or shows evidence of being damaged as a result of excessive corrosion; or current, heat, moisture or vibration; improper specification; misapplication; misuse or other operating conditions outside of OMEGA's control. Components which wear are not warranted, including but not limited to contact points, fuses, and triacs.

OMEGA is pleased to offer suggestions on the use of its various products However, OMEGA neither assumes responsibility for any omissions or errors nor assumes liability for any damages that result from the use of its products in accordance with information provided by OMEGA, either verbal or written. OMEGA warrants only that the parts manufactured by it will be as specified and free of defects. OMEGA MAKES NO OTHER WARRANTIES OR REPRESENTATIONS OF ANY KIND WHATSOEVER, EXPRESSED OR IMPLIED, EXCEPT THAT OF TITLE, AND ALL IMPLIED WARRANTIES INCLUDING ANY WARRANTY OF MERCHANTABILITY AND FITNESS FOR A PARTICULAR PURPOSE ARE HEREBY DISCLAIMED. LIMITATION OF LIABILITY: The remedies of purchaser set forth herein are exclusive and the total liability of OMEGA with respect to this order, whether based on contract, warranty, negligence, indemnification, strict liability or otherwise, shall not exceed the purchase price of the component upon which liability is based. In no event shall OMEGA be liable for consequential, incidental or special damages.

CONDITIONS: Equipment sold by OMEGA is not intended to be used, nor shall it be used: (1) as a "Basic Component" under 10 CFR 21 (NRC), used in or with any nuclear installation or activity; or (2) in medical applications or used on humans. Should any Product(s) be used in or with any nuclear installation or activity, medical application, used on humans, or misused in any way, OMEGA assumes no responsibility as set forth in our basic WARRANTY/DISCLAIMER language, and additionally, purchaser will indemnify OMEGA and hold OMEGA harmless from any liability or damage whatsoever arising out of the use of the Product(s) in such a manner.

RETURN REQUESTS / INQUIRIES

Direct all warranty and repair requests/inquiries to the OMEGA Customer Service Department. BEFORE RETURNING ANY PRODUCT(S) TO OMEGA, PURCHASER MUST OBTAIN AN AUTHORIZED RETURN (AR) NUMBER FROM OMEGA'S CUSTOMER SERVICE DEPARTMENT (IN ORDER TO AVOID PROCESSING DELAYS). The assigned AR number should then be marked on the outside of the return package and on any correspondence.

The purchaser is responsible for shipping charges, freight, insurance and proper packaging to prevent breakage in transit.

FOR **WARRANTY** RETURNS, please has the following information available BEFORE contacting OMEGA:

1. P.O. number under which the product was PURCHASED,
2. Model and serial number of the product under warranty, and
3. Repair instructions and/or specific problems relative to the product.

FOR **NON-WARRANTY** REPAIRS, consult OMEGA for current repair charges. Have the following information available BEFORE contacting OMEGA:

1. P.O. number to cover the COST of the repair,
2. Model and serial number of product, and
3. Repair instructions and/or specific problems relative to the product.

OMEGA's policy is to make running changes, not model changes, whenever an improvement is possible. This affords our customers the latest in technology and engineering.

OMEGA is a registered trademark of OMEGA ENGINEERING, INC.

(C) Copyright 1999 OMEGA ENGINEERING, INC. All rights reserved. This document may not be copied, photocopied, reproduced, translated, or reduced to any electronic medium or machine-readable form, in whole or in part, without prior written consent of OMEGA ENGINEERING, INC.

PATENT NOTICE: U.S. PAT. B1 5,368,392; 5,524,984; 5,727,880; 5,465,838; 5,823,678; 5,823,678; 5,823,679. Other U.S. and Foreign Patents and Applications Pending. Manufactured in Italy. Licensed by Omega Engineering Inc.

Where Do I Find Everything I Need for Process Measurement and Control? OMEGA...Of Course!

TEMPERATURE

- Thermocouple, RTD & Thermistor Probes, Connectors, Panels & Assemblies
- Wire: Thermocouple, RTD & Thermistor
- Calibrators & Ice Point References
- Recorders, Controllers & Process Monitors
- Infrared Pyrometers

PRESSURE, STRAIN AND FORCE

- Transducers & Strain Gauges
- Load Cells & Pressure Gauges
- Displacement Transducers
- Instrumentation & Accessories

FLOW/LEVEL

- Rotameters, Gas Mass Flowmeters & Flow Computers
- Air Velocity Indicators
- Turbine/Paddlewheel Systems
- Totalizers & Batch Controllers

pH/CONDUCTIVITY

- pH Electrodes, Testers & Accessories
- Benchtop/Laboratory Meters
- Controllers, Calibrators, Simulators & Pumps
- Industrial pH & Conductivity Equipment

DATA ACQUISITION

- Data Acquisition & Engineering Software
- Communications-Based Acquisition Systems
- Plug-in Cards for Apple, IBM & Compatibles
- Datalogging Systems
- Recorders, Printers & Plotters

HEATERS

- Heating Cable
- Cartridge & Strip Heaters
- Immersion & Band Heaters
- Flexibie Heaters
- Laboratory Heaters

ENVIRONMENTAL MONITORING AND CONTROL

- Metering & Control Instrumentation
- Refractometers
- Pumps & Tubing
- Air, Soil & Water Monitors
- Industrial Water & Wastewater Treatment
- pH, Conductivity & Dissolved Oxygen Instruments