

2 YEAR
WARRANTY



Ω OMEGA® **User's Guide**

***Shop online at
omega.comSM***

***e-mail: info@omega.com
For latest product manuals:
www.omegamanual.info***



CDB-430
Lab Conductivity/pH Meter



www.omega.com info@omega.com

Servicing North America:

U.S.A.:

Omega Engineering, Inc., One Omega Drive, P.O. Box 4047
Stamford, CT 06907-0047 USA
Toll-Free: 1-800-826-6342 (USA & Canada only)
Customer Service: 1-800-622-2378 (USA & Canada only)
Engineering Service: 1-800-872-9436 (USA & Canada only)
Tel: (203) 359-1660 Fax: (203) 359-7700
e-mail: info@omega.com

For Other Locations Visit omega.com/worldwide

MODEL CDB-430 CONDUCTIVITY/pH METER OPERATING MANUAL

SECTION 1	INTRODUCTION	
	Description	1.1
	Specification	1.2
SECTION 2	INSTALLATION	
	Unpacking	2.1
	Installation	2.2
	Displays	2.3
	Controls	2.4
	Inputs/Outputs	2.5
SECTION 3	OPERATION	
	Common Menu Options	3.1
	Using the unit with 2 sensors	3.2
	Operating the unit with only one display	3.3
	Endpoint detection	3.4
	pH MODE	
	Setting up parameters	3.5
	Entering pH Buffer Values	3.6
	pH Calibration - Automatic	3.7
	pH Calibration - Manual	3.8
	Error Codes	3.9
	mV MODE	
	Setting up parameters	3.10
	Temperature Measurement	3.11
	CONDUCTIVITY MODE	
	Setting Up Parameters	3.12
	Entering Conductivity Buffer Values	3.13
	Conductivity Mode	3.14
	Total Dissolved Solids Mode	3.15
	Resistivity Mode	3.16
	Calibration	3.17
	Datalogging	3.18
	Good Practice Guidelines	3.19
	Operating the Instrument with Optional Stirrer	3.20
SECTION 4	MAINTENANCE	
SECTION 5	OPTIONAL ACCESSORIES	
SECTION 6	INTERFACING	

EC Declaration of Conformity

SECTION 1

INTRODUCTION

1.1 INSTRUMENT DESCRIPTION

The Model CDB-430 is a comprehensively specified unit designed to measure both Conductivity and pH. This dual measurement system enables the user to benefit from the combined technologies of the Model PHB-320 pH Meter and the Model CDB-420 Conductivity Meter.

The product benefits from the use of an enhanced LCD Graphics display enabling conductivity, pH and temperature readings to be displayed simultaneously. In addition, the increased screen size provides pH resolution to three decimal places and an enhanced mV resolution of 0.1mV.

Operator interface is provided via a dedicated, sealed membrane keypad which incorporates full numeric input capability.

The Model CDB-430 utilises separate conductivity and pH sensors which may be used together or independently. All readings are compensated automatically for the appropriate temperature coefficient. A separate temperature input enables the use of alternative conductivity and pH electrodes whilst maintaining accurate compensation. When conductivity and pH are measured together in the same container no electrical interference between the two will take place.

An analog output facility is provided and the RS232 serial, digital output carries data relating to both parameters. Full G.L.P. protocols relating to traceability of calibration and sample results are fully supported.

1.2 INSTRUMENT SPECIFICATIONS

pH

Range -2 to 19.999pH
Resolution 0.1/0.01/0.001pH
Accuracy ± 0.003 pH

mV

Range -1999.9 to 1999.9mV
Resolution 0.1mV
Accuracy ± 0.2 mV

Conductivity

Ranges /Resolution: 0 to 19.99S (using X10 cell) (0.01S)
0 to 1.999S (0.001S)
0 to 199.9mS (0.1mS)
0 to 19.99mS (0.01mS)
0 to 1.999mS (0.001mS)
0 to 199.9 μ S (0.1 μ S)
0 to 19.99 μ S (0.01 μ S)
0 to 1.999 μ S (0.001 μ S)
Accuracy: $\pm 0.5\%$ ± 2 digits

TDS

Ranges/Resolution: 0 to 2000g/l (1g/l)
0 to 200g/l (0.1g/l)
0 to 20g/l (0.01g/l)
0 to 2000mg/l (1mg/l)
0 to 200mg/l (0.1mg/l)
0 to 20mg/l (0.01mg/l)
Accuracy: $\pm 0.5\%$ ± 2 digits

Resistivity

Range/Resolution: 0 to 20M Ω ms (0.01M Ω ms)

Salinity

Range/Resolution: 0 to 99.9 (0.1)
Accuracy: 0 to 35 ± 1 / 35 to 99.9 ± 3 of reading

Temperature

Range -10 to 105°C / 14 to 221°F
Resolution 0.1°C / 1°F
Accuracy ± 0.5 °C / ± 1 °F

ATC Range: 0 to 100°C / 32 to 212°F

Manual Temp. Comp. Range: 0 to 100°C / 32 to 212°F

Auto Buffer Recognition 2, 4, 7, 9 and 10pH buffers with manual override facility

Calibration 1, 2 or 3 point pH

Cell Constant: Digitally settable 0.015 to 19.99

Reference Temp: 18, 20, 25°C

Temperature Coeff.:	0.00 to 4.00%/°C linear and non-linear temperature coefficient characteristics associated with low conductivity water
Platinising Socket:	Applying 10V a.c. 0.05Hz
Outputs	Analog 1mV per digit / Bi-directional RS232 Hi/Lo alarm outputs open collector 0.5A 50V max.
Datalogger	100 results
Clock	24 hour, hrs/min/sec or day of month, month and year/leap year corrected
Alarm Points	-2 to 19.999pH ±1999.9mV 0 to 19.99S 0 to 2000g/L 0 to 20MΩ
G.L.P.	Calibration reminder with an interval of 1 to 999 hours from last calibration Timed printout with an interval from 1 second to 1 day
Display	LCD Graphics
Power	Power Supply 9V a.c.
Size	275(l) x 240(w) x 150(d) mm
Weight	1.2Kg

SECTION 2

INSTALLATION

2.1 UNPACKING

Remove the Model CDB-430 from the packaging and ensure the items within the package are as ordered.

Any shortages or damage should be reported to Omega's Customer Service Department.

2.2 INSTALLATION

LCD CONTRAST

The LCD contrast can be set at any time. The LCD contrast potentiometer is accessible through the rear panel adjacent to the power socket.

This adjustment should only need to be made on receipt of the instrument. After initial adjustment the instrument will automatically adjust the contrast depending on the temperature of the glass.



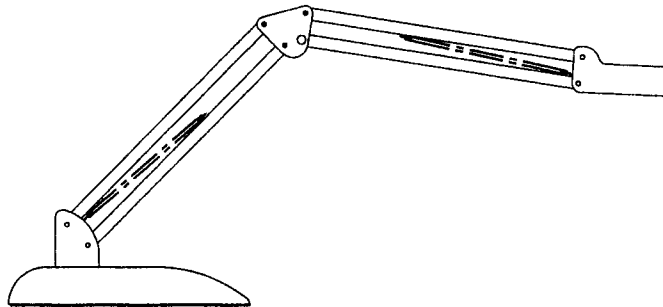

For instruments supplied with the swing arm electrode holder the following assembly instructions should be carried out:

1. Unpack the assembly and ensure the following items are present:
 - a) base block and b) swing arm. Assemble as illustrated. The moulded pivot is a tight push onto the pin.



2. Fit the electrode(s) into the cut-out in the support block. The optional temperature probe, if supplied, should be placed into the small hole in the centre of the block. The cable(s) should be passed through the retaining clip on the holder and connected to the respective socket on the rear panel.

SETTING LANGUAGE

Move to the SETUP menu using the arrow keys and press the  key. Move the cursor to the INSTRUMENT SETUP mode using the  arrow key and press the  key. Move the cursor to the LANGUAGE menu and select the appropriate language by using the arrow keys. Once selected move to the EXIT option and press the  key. Pressing the  key a second time will return the instrument to the measurement mode.

2.3 DISPLAYS

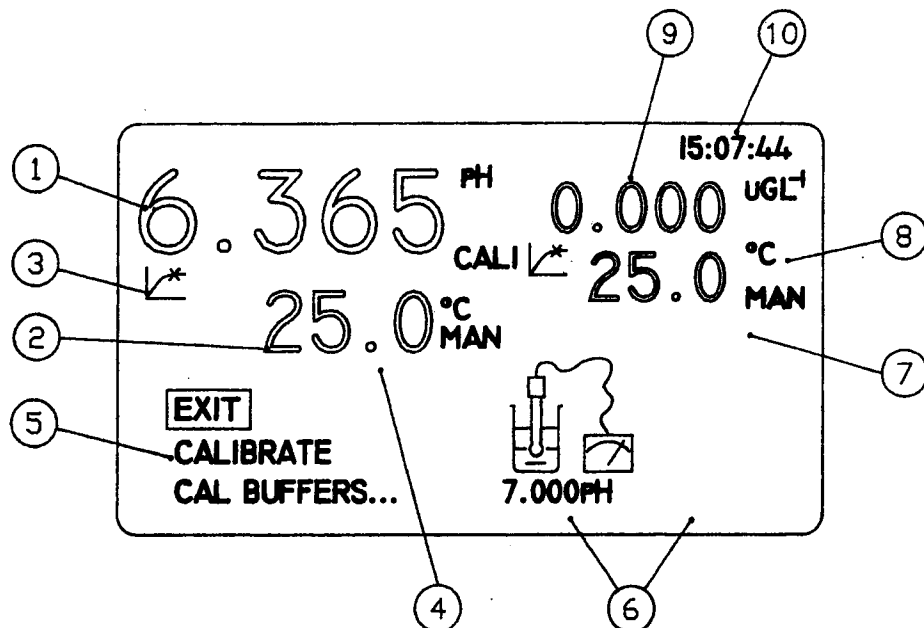

1. **PRIMARY DISPLAY** - sensor 1 display currently selected as primary reading. Units of measurement and calibration point will also be shown at the side of the main display.
2. **TEMPERATURE DISPLAY** - sensor 1 temperature display. Selected measurement unit and MAN to indicate manual temperature will be shown at the side of the display.
3. **ENDPOINT SYMBOL** - displayed once a stable reading is detected and is maintained until the input changes.
4. **ERROR MESSAGES** - displays error messages for sensor 1.
5. **MENU** - used for selection of modes of operation. The selected mode is reverse highlighted.
6. **ICONS** - used in pH and Conductivity modes to prompt steps of calibration and sample measurement.
7. **ERROR MESSAGES** - displays error messages for sensor 2.
8. **TEMPERATURE DISPLAY** - sensor 2 temperature display. Selected measurement unit and MAN to indicate manual temperature will be shown at the side of the display.
9. **SECONDARY DISPLAY** - sensor 2 display currently selected as secondary reading. Units of measurement and calibration point will also be shown at the side of the main display.
10. **REAL TIME CLOCK** - giving continuous display of hours, minutes and seconds or day, month and year. All logged results are automatically time stamped.

2.4 CONTROLS

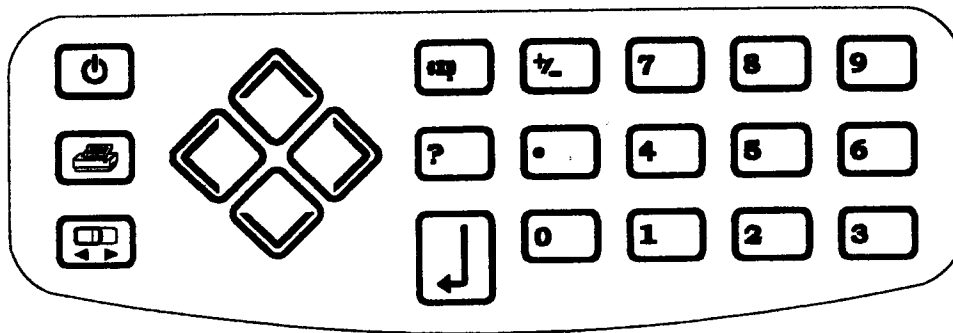

Switches the instrument on and to standby.



Print key. Provides a printout of the current readings with an incremental sample number depending on instrument operating mode. When pressed for the first time after a calibration, the print out will give calibration information. The incremental sample number will be reset after a calibration if auto cal print is set to on.



These keys are used to move around menus and for entering non-numerical functions.



Display select key. Used to toggle between primary and secondary displays.



Used to enter the exponential part of a value.
e.g. to enter 1.3×10^{-3} the key sequence is 1, ., 3, EXP, 3



Help key. Provides on-line help for menu options.



Used to select the displayed menu options and for entering parameters.



Used to change the sign of an entered number. It should be pressed after entering the value. To enter a negative exponent this key should be pressed after entering the exponent value - e.g. 1×10^{-3} - the key sequence is 1, EXP, 3, ±



Numeric keys 0 - 9 are used to enter numeric data for measurement parameters, calibration data and limits.

2.5 INPUTS/OUTPUTS

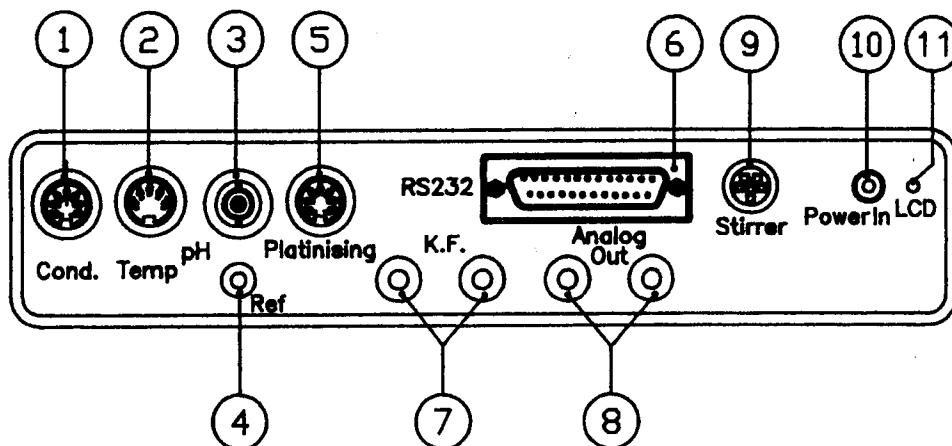

- | | | |
|-----|-------------------------|---|
| 1. | 7 PIN DIN SOCKET | Connection socket for the standard cell supplied with the unit |
| 2. | TEMP SOCKET | 5 pin DIN socket for the automatic temperature compensation (ATC) probe (pH) |
| 3. | pH SOCKET | BNC connection socket |
| 4. | REF SOCKET | 2mm pin connection socket for separate reference electrode |
| 5. | 7 PIN DIN SOCKET | Platinising socket |
| 6. | OUTPUT SOCKET | 25 way D socket for RS232 and alarm connections |
| 7. | KARL FISCHER | 2 x 4mm sockets. Polarised output. Karl Fischer titrations are enabled by the provision of a 10 μ A polarising current output |
| 8. | ANALOG OUT | 2 x 4mm sockets. Analog output proportional to primary display reading |
| 9. | STIRRER | Connection socket for optional stirrer |
| 10. | POWER IN | 2.1 x 5.5mm socket allowing the power supply to be connected to the unit |
| 11. | LCD | LCD contrast potentiometer |

SECTION 3

OPERATION

Connect the power supply appropriate to the supply being used to the instrument via the rear panel power socket. Connect the electrode(s), and ATC probes(s) if used, to the appropriate rear panel sockets.

When power is applied to the instrument the screen will show the mode last used prior to switch off. The measurement mode will be indicated by displayed units. To change the mode or exit, move to the required mode by using the arrow keys and then press .

MENU OPTIONS - mV

pH	mV	STORE
REL	RECALL	SETUP

pH	pH mode
mV	millivolt mode
STORE	used to store the displayed readings
REL	absolute or relative millivolt mode selection
RECALL	recall mode for stored readings
SETUP	used to set up mode specific parameters, instrument and clock set up parameters

MENU OPTIONS - pH

pH	mV	STORE
CAL	RECALL	SETUP

pH	pH mode
mV	millivolt mode
STORE	used to store the displayed reading
CAL	calibration mode - the help key on this menu option gives access to last calibration details
RECALL	recall mode for stored readings
SETUP	used to set up mode specific parameters, instrument and clock set up parameters

MENU OPTIONS - CONDUCTIVITY

TDS	RESIS	STORE
TEMP	SAL	RCL
CAL	ZERO	SETUP

TDS	Total Dissolved Solids mode
RESIS	Resistivity mode
STORE	Used to store the displayed reading
TEMP	Temperature mode
SAL	Salinity mode
RCL	Recall mode for stored readings
CAL	Conductivity calibration mode
ZERO	Conductivity zero offset
SETUP	Used to set up mode specific parameters, instrument and clock set up

MENU OPTIONS - TDS

COND	RESIS	STORE
TEMP	SAL	RCL
CAL	ZERO	SETUP

COND	Conductivity mode
RESIS	Resistivity mode
STORE	Used to store the displayed reading
TEMP	Temperature mode
SAL	Salinity mode
RCL	Recall mode for stored readings
CAL	Conductivity calibration mode
ZERO	Conductivity zero offset
SETUP	Used to set up mode specific parameters, instrument and clock set up and access G.L.P features

MENU OPTIONS - RESISTIVITY

COND	TDS	STORE
TEMP	SAL	RCL
CAL	ZERO	SETUP

COND	Conductivity mode
TDS	Total Dissolved Solids mode
STORE	Used to store the displayed reading
TEMP	Temperature mode
SAL	Salinity mode
RCL	Recall mode for stored readings
CAL	Conductivity calibration mode
ZERO	Conductivity zero offset
SETUP	Used to set up mode specific parameters, instrument and clock set up

3.1 COMMON MENU OPTIONS

NOTE: Any menu option suffixed with ... means access can be gained to a sub-menu below this level.

INSTRUMENT SETUP MENU

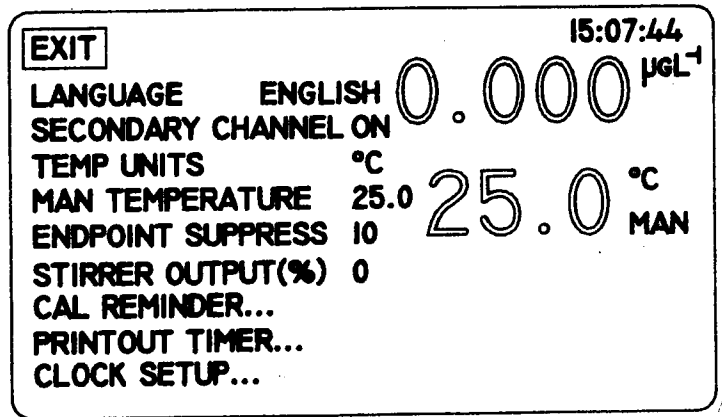

EXIT	menu escape key
LANGUAGE	used to set preferred language option
SECONDARY CHANNEL	allows the secondary display to be suppressed. A suppressed input will also be omitted from printed results
TEMP UNITS	used for selection of measurement in °C or °F
MAN TEMPERATURE	used to manually enter temperature values only if no ATC probe(s) are connected
ENDPOINT SUPPRESS	allows specific endpoint time to be entered for sample under test. If the sample is known to have a slow stabilisation point then the endpoint can be suppressed to the desired time
STIRRER OUTPUT (%)	used to set stirrer speed
CAL REMINDER...	allows the G.L.P. cal reminder functions to be set up
PRINTOUT TIMER...	allows the timer which prints readings at a preset interval to be set up
CLOCK SETUP...	used to select clock set up menu

SETTING LANGUAGE

Select LANGUAGE menu using the key and use arrow key or press key to highlight options. Select the required language using the keys and press to confirm.





SECONDARY CHANNEL

Select SECONDARY CHANNEL menu using the key and use arrow key or press to highlight options. Select ON or OFF option as required and press to confirm.





TEMP UNITS

Select TEMP UNITS menu using the key and use arrow key or press to highlight options. Select °C or °F option using the keys and press to confirm.





MAN. TEMPERATURE (default value 25°C)

Select MAN. TEMPERATURE menu using the  key and use  arrow key or press  to highlight options. Enter the new value using the numeric keypad and press  to confirm. If a mistake is made the  key can be used as a delete key, starting from the lowest digit and then re-enter the value using the numeric keys. To delete the whole entry keep pressing the key until a blank box appears. To default to the original value press the key again.

ENDPOINT SUPPRESS

Select the ENDPOINT SUPPRESS menu using the  key and use  or  key to highlight options. The value may be adjusted by selecting the required time, in units of seconds (1-999), using the numeric keys and then press  to confirm.

STIRRER OUTPUT (%)

Select the STIRRER OUTPUT (%) menu using the  key and use the  or  key to highlight the option. The value may be adjusted (0-100) using the numeric keys and then pressing  to confirm.

CAL REMINDER... (refer sub menu)

PRINTOUT TIMER... (refer sub menu)



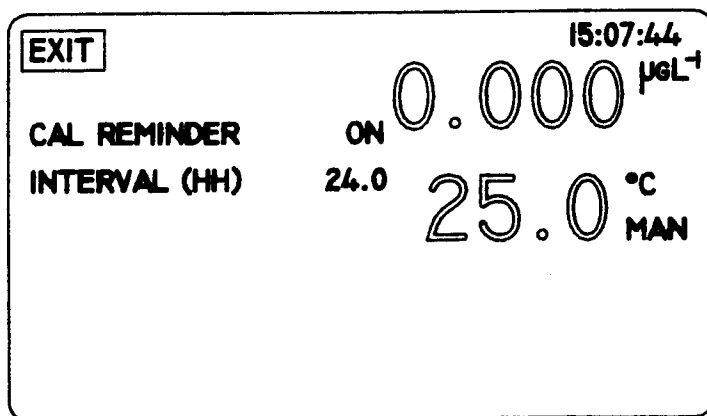

CLOCK SETUP... (refer sub menu)

CAL REMINDER... SUB-MENU







EXIT menu escape key
CAL REMINDER setting to ON will prompt re-calibration
setting to OFF will suppress the message
INTERVAL (HH) allows interval to be set between 1 and 999 hours from the last calibration prompt

CAL REMINDER

Select CAL REMINDER menu using the  key and use  arrow key or press  to highlight options.
Select ON or OFF option as required and press  to confirm.

INTERVAL (HH)





Select the INTERVAL (HH) menu using the  key and use  or  key to highlight options. The value may be adjusted by selecting the required time, in units of 1/10 of an hour (6 minutes) using the numeric keys and then press  to confirm.

PRINTOUT TIMER SUB-MENU





EXIT		15:07:44
		0.000 $\mu\text{g/L}^{-1}$
AUTO CAL PRINT	ON	
CAL PRINT	SENSOR#1&2	
TIMED PRINT	OFF	25.0 °C
		MAN
INTERVAL	00:00:10	
START	00:00:00	
STOP	23:59:59	

EXIT	menu escape key
AUTO CAL PRINT	when set to ON this will automatically set sample number to no. 1 after calibration
CAL PRINT	specifies which sensor information will be included in a calibration printout
TIMED PRINT	allows the timed print facility to be turned on or off using the arrow keys
INTERVAL	can be set for hours, minutes and seconds. A printout will be initiated at that interval
START	start time set
STOP	stop time set





AUTO CAL PRINT

Select AUTO CAL PRINT menu using the  key and use  arrow key or press  to highlight options. Select ON or OFF option as required and press  to confirm.





CAL PRINT

Select CAL PRINT menu using the  key and use  key or  key to highlight options. Select Sensor 1, Sensor 2 or Sensors 1& 2 as required and press  to confirm.





TIMED PRINT

Select TIMED PRINT menu using the  key and use  arrow key or press  to highlight options. Select ON or OFF option as required and press  to confirm.





INTERVAL

Select the INTERVAL menu using the  key and use  or  key to highlight options. The value may be adjusted by selecting the required time, in units of hours:minutes:seconds using the numeric keys and then press  to confirm.

START

Select the START menu using the  key and use  or  key to highlight options. The value may be adjusted by selecting the required time, in units of hours:minutes:seconds using the numeric keys and then press  to confirm.

STOP

Select the STOP menu using the  key and use  or  key to highlight options. The value may be adjusted by selecting the required time, in units of hours:minutes:seconds using the numeric keys and then press  to confirm.

ALARM POINTS... SUB-MENU

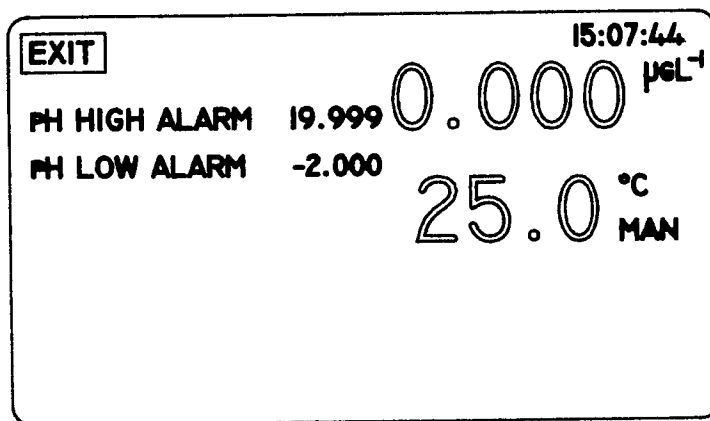

EXIT

menu escape key





XX HIGH ALARM

if the reading exceeds this value an alarm warning will appear on the display and the high output alarm will become active





XX LOW ALARM

if the reading exceeds this value an alarm warning will appear on the display and the low output alarm will become active

HIGH ALARM (default 19.999)

Select HIGH ALARM menu using the  key and use  or  key to highlight options. The value may be adjusted using the numeric keys and then pressing  to confirm.

LOW ALARM (default -2.000)



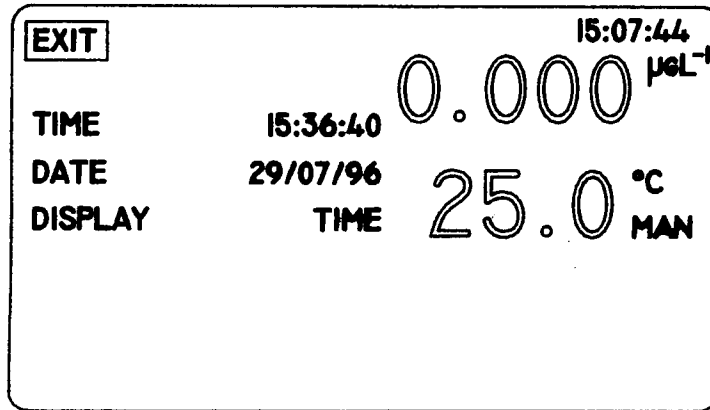

Select LOW ALARM menu using the  key and use  or  key to highlight options. The value may be adjusted using the numeric keys and then pressing  to confirm.

CLOCK SET UP SUB-MENU







EXIT	menu escape key
TIME	real time clock set up
DATE	date set up
DISPLAY	used to select display of time, date or none





TIME

Select the TIME menu using the  key and use  or  key to highlight options. The value may be adjusted by selecting the required time, in units of hours:minutes:seconds using the numeric keys and then press  to confirm.

DATE

Select the DATE menu using the  key and use  or  key to highlight options. The value may be adjusted by selecting the required time, in units of day:month:year using the numeric keys and then press  to confirm.

DISPLAY

Select DISPLAY menu using the  key and use  arrow key or press  to highlight options. Select time, date or none option as required and press  to confirm.

3.2 USING THE INSTRUMENT WITH 2 SENSORS



The Model CDB-430 is designed to operate with the following sensor combinations - pH only, Conductivity only or pH and Conductivity combined.

The instrument can be operated with either one or two sensors connected. Access to the individual displays can be made using the  key. Using this key will focus on one of the two sensors, thus providing a primary and secondary display (as shown below). The primary display will be shown over half of the screen, with the secondary display appearing in the opposite corner.

Access can now be gained to the parameters for the primary sensor. The menu options will now move over to the primary sensor and allow operation to take place as normal.

The secondary sensor will not be disabled automatically and will continue to measure.

3.3 OPERATING THE INSTRUMENT WITH 1 SENSOR

The instrument has the facility to disable the secondary display, allowing the the use of 1 sensor only. This can be achieved by entering the INSTRUMENT SET UP and setting the SECONDARY CHANNEL option to OFF using the   keys. The instrument will now only show the primary sensor details.

NOTE: This will be globally disabled.

3.4 ENDPOINT DETECTION

The endpoint detection facility can be altered to suit the requirements of individual tests being carried out on very slow reacting chemicals.

To change the endpoint detection enter the INSTRUMENT SETUP mode and highlight the ENDPOINT SUPPRESS option. The value may be adjusted by selecting the required time, in units of seconds (1-999), using the arrow keys and then press .

The instrument will not show the endpoint symbol until the selected time has elapsed. The time entered is shared time on both channels i.e. it applies to both simultaneously.

3.5 pH MODE - SETTING UP PARAMETERS

pH SET UP MENU

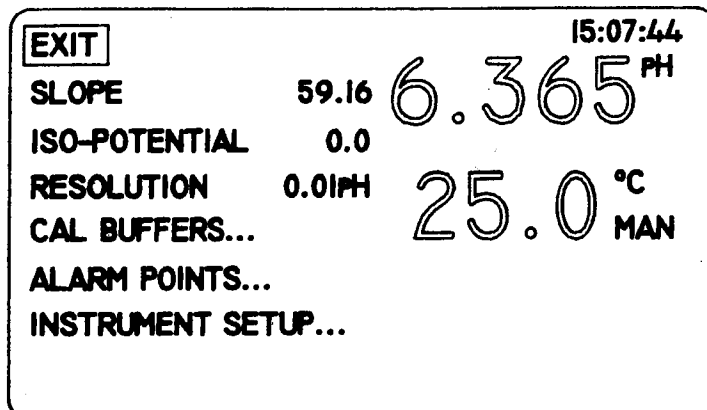

EXIT	menu escape key
SLOPE	electrode slope value between CAL1 and CAL2
ISO-POTENTIAL	allows the sensor iso-potential to be changed. The iso-potential point is the sensor potential which does not change with temperature
RESOLUTION	allows the number of decimal places for the measured parameter shown on the display to be changed using the arrow keys
CAL BUFFERS...	allows the calibration buffers for the selected mode and sensor input to be viewed and changed
ALARM POINTS...	used to view and change alarm points for the selected mode and channel
INSTRUMENT SETUP...	used to select the next set up menu for instrument parameters

ELECTRODE SLOPE (1 point cal)

Enter pH SETUP menu and select SLOPE. Adjust the reading as required using the numeric keys and press . The reading will default to 2 decimal places.

ISOPOTENTIAL POINT



Enter pH SETUP menu and select ISOPOTENTIAL. Adjust the reading as required using the numeric keys and press .

RESOLUTION

Enter pH SETUP menu and select RESOLUTION. Select the preferred resolution (0.001, 0.01 or 0.1) from a set of pre-defined options using the arrow keys and press .

3.6 ENTERING pH BUFFER VALUES



The Model CDB-430 will allow pH buffer values to be entered in two ways - either in pH SETUP or CALIBRATION.

Select the pH mode using the arrow keys and press . Move the cursor to highlight the SETUP menu option and press . Select the CAL BUFFERS... menu option using the arrow keys and press .

Selecting this menu allows access to 3 buffer settings. Buffer values can be entered in any order and do not need to be incremental or decramental.

Adjustment can be made by entering the required buffer value via the numeric keys.

If a mistake is made the  key can be used as a delete key, starting from lowest digit. If you wish to alter the entered value keep pressing this key until a blank box appears. Pressing the key again will default to the original value.

Once the correct value is entered pressing the  key will update the display to the new value corrected to 3 decimal places. If you wish to abort pressing the  key will return the cursor to CAL 1 BUFFER.

If a value which is higher or lower than the preset instrument default values is entered the unit will automatically default to the appropriate default values (above or below).

Values can be entered as exponential numbers and these will be shown as standard values.

It is possible to change polarity at any time but the -ve sign can only be applied after entering a number.

CALIBRATION MODE

Buffer values can be changed at the point of calibration, eliminating the need to exit the calibration routine. On entering the CAL mode the menu option CAL BUFFERS should be selected and appropriate values should be entered using the numeric keypad.

3.7 pH CALIBRATION - AUTOMATIC

Auto buffer recognition operates over the range of 0 to 100°C and will recognise 2.00, 4.00, 7.00, 9.22 and 10.00pH. If calibration values other than 2.00, 4.00, 7.00, 9.22 and 10.00 are set the instrument will consider this to be a manual buffer calibration.

NOTE: Rinse electrode(s) in deionised water between measurements.

Calibration is performed by selecting the pH mode and then moving the cursor to the CAL menu option and pressing . The instrument will then show:

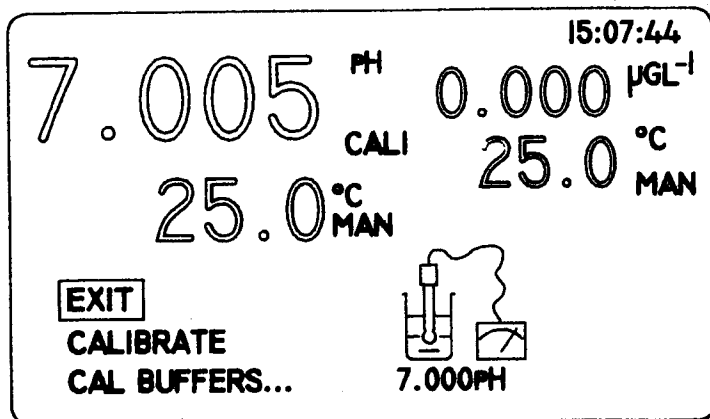



An icon will appear indicating the CAL 1 buffer value and the first part of the calibration. The buffer value(s) can be changed at this point by entering the CAL BUFFERS... menu and setting new values by using the numeric keys and pressing .

To calibrate the instrument select the CALIBRATE menu option using the arrow keys. The electrode(s) should be placed into the first buffer solution and the reading allowed to stabilise (the endpoint symbol will be displayed) prior to pressing the  key. The display will then update to the standard buffer value, corrected for temperature (actual temperature will be displayed).

The icon will then change to show the CAL 2 buffer value. If a one point calibration only is required select the EXIT option using the arrow keys and pressing . The instrument will return to the pH mode.

If a two point calibration is required the electrode(s) should be rinsed and then placed into the second buffer solution. Allow the reading to stabilise (the endpoint symbol will be displayed) prior to pressing the  key. The display will then update to the standard buffer value, corrected for temperature (actual temperature will be displayed).

The icon will then change to show the CAL 3 buffer value. If a two point calibration only is required select the EXIT option by using the arrow keys and press  . The instrument will then return to the pH mode.

If a three point calibration is required the electrode(s) should be rinsed and then placed into the third buffer solution. Allow the reading to stabilise (the endpoint symbol will be displayed) prior to pressing  . The display will then update to the standard buffer value, corrected for temperature (actual temperature will be displayed). The instrument will then return to the main pH display.

Once calibration is completed the instrument is now ready to perform sample measurement.

Rinse electrode(s) and place in sample. Allow the reading to stabilise (the endpoint symbol will be displayed).

Repeat for each sample

At the end of sample measurement re-check the calibration of the instrument using one standard solution.

3.8 pH CALIBRATION - MANUAL

Select the pH menu. Entering buffer values manually can be carried out in either the pH SETUP MENU or in CALIBRATION mode.

Calibration is performed by selecting the pH mode and then moving the cursor to the CAL menu option and pressing  .

An icon will appear indicating the CAL 1 buffer value and the first part of the calibration. The buffer value(s) can be changed at this point by entering the CAL BUFFERS... menu and setting new values by using the numeric keys and pressing  .

To calibrate the instrument select the CALIBRATE menu option using the arrow keys. The electrode(s) should be placed into the first buffer solution and the reading allowed to stabilise (the endpoint symbol will be displayed) prior to pressing the  key. The display will then update to the standard buffer value, corrected for temperature (actual temperature will be displayed).

The icon will then change to show the CAL 2 buffer value. If a one point calibration only is required select the EXIT option using the arrow keys and pressing  . The instrument will return to the pH mode.

If a two point calibration is required the electrode(s) should be rinsed and then placed into the second buffer solution. Allow the reading to stabilise (the endpoint symbol will be displayed) prior to pressing the  key. The display will then update to the standard buffer value, corrected for temperature (actual temperature will be displayed).

The icon will then change to show the CAL 3 buffer value. If a two point calibration only is required select the EXIT option by using the arrow keys and press . The instrument will then return to the pH mode.

If a three point calibration is required the electrode(s) should be rinsed and then placed into the third buffer solution. Allow the reading to stabilise (the endpoint symbol will be displayed) prior to pressing . The display will then update to the standard buffer value, corrected for temperature (actual temperature will be displayed). The instrument will then return to the main pH display.

Once calibration is completed the instrument is now ready to perform sample measurement.

Rinse electrode(s) and place in sample. Allow the reading to stabilise (the endpoint symbol will be displayed).

Repeat for each sample

At the end of sample measurement re-check the calibration of the instrument using one standard solution.

3.9 ERROR CODES

If a problem is detected during calibration the following error codes will be displayed;

CAL OUT OF RANGE

This indicates that the instrument has calculated an electrode offset at pH7 outside the -30 to +30mV limits. The error code will be displayed for 3 seconds and will then reset the calibration back to the ideal Nernst response (0mV @ pH 7, 59.16mV/pH @ 25°C).

SLOPE OUT OF RANGE

This indicates that the slope value is out of range. The error code will be displayed for 3 seconds and will then reset the calibration data back to the ideal Nernst response (0mV @ pH 7, 59.16mV/pH @ 25°C).

3.10 mV MODE - SETTING UP PARAMETERS

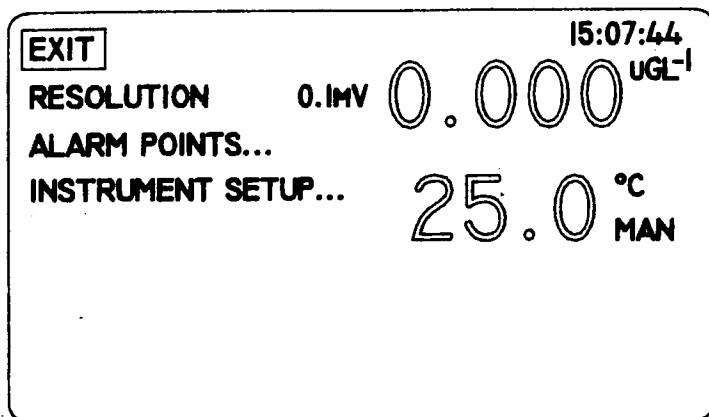

- EXIT** menu escape key
- RESOLUTION** allows the number of decimal places for the measured parameter on the display to be changed using the arrow keys
- ALARM POINTS....** allows the alarm points for the selected mode and channel to be viewed and changed
- INSTRUMENT SETUP...** used to select the next set up menu for instrument parameters

RESOLUTION

Enter mV SETUP menu and select RESOLUTION. Select the preferred resolution (0.1 or 1mV) from pre-defined options using the arrow keys and press .

Absolute Millivolts

When this mode is selected the unit will display the actual voltage developed by the electrode when it is immersed in a solution containing ions to which the electrode is sensitive.

The electrode may be a combination type or a suitable sensing/reference pair, depending on the specific test being carried out.

pH, Redox and Ion Selective electrodes can all be used in this mode. Most of these determinations will require the preparation of calibration curves or other analytical methods to enable the mV reading to be converted to a concentration unit. For further information on these determinations refer to the electrode instructions, which will normally give details of calibration solutions, interferences and the limits of the methodology.

A very useful application of the Absolute mV range is for monitoring the performance of standard pH electrodes. Using accurate and fresh buffers at a constant temperature, the millivolt output of the electrode should be noted and compared to the theoretical ideal. As the electrode ages, becomes contaminated or

dirty, these values will drift, indicating that corrective action should be taken.



Recording these values as part of a routine Quality Control program can give a good indication of the condition of the electrode.

Relative Millivolts

This mode is suitable for determinations using Redox and Ion Selective Electrodes and has the additional benefit of being able to zero any offset voltage developed by the electrode in a blank solution, i.e; a solution that has none of the ions to be measured, but has all the other characteristics of the unknown samples. A blank solution would normally have its ionic strength and pH adjusted as required for the electrode in use. As the display is zeroed automatically when the Relative millivolt mode is selected, it is necessary to immerse the electrode in the blank solution with the Absolute mV mode selected. When the reading has stabilised the Relative mV mode should then be selected. The display will be set to zero, thereby removing any offset voltage.

Sample measurement is then carried out by using a variety of well tried analytical methods; from simple calibration curves through titrations, to single and multiple addition methods.



mV Measurement

Select the mV mode by using the arrow keys and pressing . The instrument can toggle between Absolute and Relative millivolts by using the  key with REL or ABS menu option highlighted. Relative mV is indicated by REL appearing on the display.

3.11 TEMPERATURE MEASUREMENT

The instrument will perform temperature measurement by using an ATC probe, the Conductivity probe or both.

If neither is present the instrument will revert to manual temperature measurement.

Manual values can be entered via the SETUP and INSTRUMENT SETUP... menus and selecting MAN TEMPERATURE using the arrow keys and pressing . Adjustment is made using the numeric keypad and pressing .

3.12 CONDUCTIVITY MODE - SETTING UP PARAMETERS

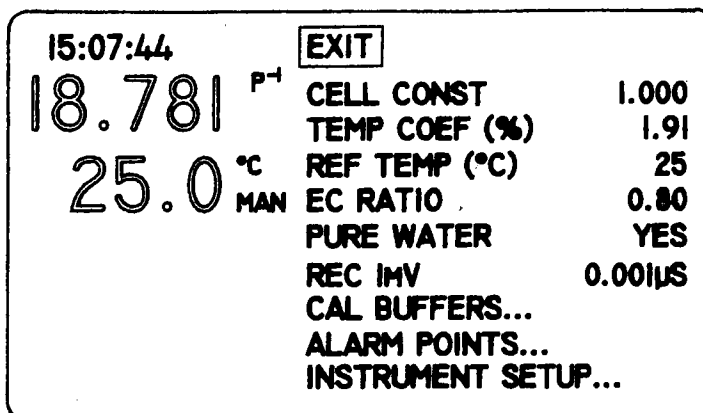

SET UP MENU



EXIT	menu escape key.
CELL CONSTANT	this is the cell constant applied to the conductivity cell when performing a 1 point calibration.
TEMP COEFF (%)	used to set the temperature coefficient (in units of %/°C) value of the sample under test.
REF TEMP (°C)	used to set the temperature to which the conductivity measurements are referenced to.
EC RATIO	the ratio between Electrical Conductivity (EC) and Total Dissolved Solids (TDS) is a variable dependent upon the electrolyte balance of the solution under test. It is normal for this ratio to be between 0.55 and 0.7. The commonly accepted default value is 0.6.
PURE WATER	used to enable the non-linear temperature coefficient characteristics associated with low conductivity water.
REC 1mV	allows recorder output sensitivity to be entered. The value entered will give a 1mV change in recorder output.
CAL BUFFERS ...	allows the calibration buffers for the selected mode and sensor input to be viewed and changed.
ALARM POINTS ...	used to view and change alarm points for the selected mode and channel.
INSTRUMENT SET UP	used to select the next set up menu for instrument parameters.

3.13 ENTERING CONDUCTIVITY BUFFER VALUES



The Model CDB-430 will allow calibration values to be entered in two ways - either in COND SETUP or CALIBRATION.

Select the Conductivity/TDS mode using the arrow keys and press . Move the cursor to highlight the SETUP menu option and press . Select the CAL BUFFERS... menu option using the arrow keys and press .

Selecting this menu allows access to 3 buffer settings. Values must be entered in increasing or decreasing order.

Adjustment can be made by entering the required buffer value via the numeric keys.

If a mistake is made the  key can be used as a delete key, starting from lowest digit. If you wish to alter the entered value keep pressing this key until a blank box appears. Pressing the key again will default to the original value.

Once the correct value is entered pressing the  key will update the display to the new value corrected to 3 decimal places. If you wish to abort pressing the  key will return the cursor to CAL 1 BUFFER.

If a value which is higher or lower than the preset instrument default values is entered the unit will automatically default to the appropriate default values (above or below).

Values can be entered as exponential numbers and these will be shown as standard values.

It is possible to change polarity at any time but the -ve sign can only be applied after entering a number.

CALIBRATION MODE

Buffer values can be changed at the point of calibration, eliminating the need to exit the calibration routine. On entering the CAL mode the menu option CAL BUFFERS ... should be selected and appropriate values should be entered using the numeric keypad.

3.14 CONDUCTIVITY MODE

This gives a direct readout of the conductivity of the sample under test. The auto ranging facility will give the optimum display resolution with units of S, mS or μ S.

3.15 TOTAL DISSOLVED SOLIDS MODE

This gives a direct readout of the total dissolved solids (TDS) contained within the sample under test. The auto ranging facility will give the optimum display resolution with units in g/l or mg/l.

3.16 RESISTIVITY MODE

This gives a direct readout of the resistivity of the sample under test to a resolution of 0.01M Ω hms.

3.17 CALIBRATION

The CDB-430 has three methods of calibration available. The method of calibration used is determined by the level of accuracy required.

PREPARATION OF CONDUCTIVITY STANDARDS

Suitable conductivity standards are available commercially or these can be made up as required from A.R. reagents with reference to the relevant physical tables.

Method for general purpose conductivity standard

- 1) Accurately weigh out 0.746 grammes of dried A.R. grade Potassium Chloride (KCl).
- 2) Dissolve in 1 litre of good quality deionised water.

This produces a 0.01N solution with a conductivity of 1413 μ S @ 25°C.





Storage



This solution must be stored in a plastic container and the air space should be kept to an absolute minimum. The shelf life of 1 week can be increased by storing below 4°C, but where any doubt exists about the viability of stored solution a fresh batch should be prepared.

CALIBRATION (with Known Cell Constant)





This method is the most basic and least accurate.



Enter into the SET UP mode by selecting the SET UP menu option and pressing the  key.

Select the CELL CONST menu option using the   keys. Once highlighted, adjustment of the cell constant proceeds by pressing . The value can then be adjusted using the numeric keys and pressing .

Zero the cell by selecting the ZERO option using the   keys. Hold the cell in free air, once the reading has stabilised i.e. the endpoint symbol has appeared, press the  key. This will cause the primary display to read zero. Should the instrument detect that the offset required to zero the cell is too great (>2 μ S) a CAL OUT OF RANGE error will be displayed for approx. 2 seconds and the instrument will not perform the zero calibration.

Prior to entering the calibration routine the standard solution value must be entered. Enter into the SET UP mode by selecting the SET UP menu option and pressing the  key.

Select the CAL BUFFERS ... menu option using the   keys. Once highlighted, adjustment of the standard solution proceeds by pressing . The value can then be adjusted using the numeric keys and pressing .

Zero the cell by selecting the ZERO option using the   keys. Hold the cell in free air, once the reading has stabilised i.e. the endpoint symbol has appeared, press the  key. This will cause the primary display to read zero. Should the instrument detect that the offset required to zero the cell is too great ($>2\mu\text{S}$) a CAL OUT OF RANGE error will be displayed for approx. 2 seconds and the instrument will not perform the zero calibration.

Calibration is performed by selecting the pH mode and then moving the cursor to the CAL menu option and pressing .

An icon will appear indicating the CAL 1 buffer value and the first part of the calibration. The buffer value(s) can be changed at this point by entering the CAL BUFFERS... menu and setting new values by using the numeric keys and pressing .

To calibrate the instrument select the CALIBRATE menu option using the arrow keys. The electrode(s) should be placed into the first buffer solution and the reading allowed to stabilise (the endpoint symbol will be displayed) prior to pressing the  key. The display will then update to the buffer value.

The icon will then change to show the CAL 2 buffer value. If a one point calibration only is required select the EXIT option using the arrow keys and pressing . The instrument will return to the COND mode.

If a two point calibration is required the electrode(s) should be rinsed and then placed into the second buffer solution. Allow the reading to stabilise (the endpoint symbol will be displayed) prior to pressing the  key. The display will then update to the buffer value.

The icon will then change to show the CAL 3 buffer value. If a two point calibration only is required select the EXIT option by using the arrow keys and press . The instrument will then return to the COND mode.

If a three point calibration is required the electrode(s) should be rinsed and then placed into the third buffer solution. Allow the reading to stabilise (the endpoint symbol will be displayed) prior to pressing . The display will then update to the buffer value. The instrument will then return to the main COND display.

Once calibration is completed the instrument is now ready to perform sample measurement.

Rinse electrode(s) and place in sample. Allow the reading to stabilise (the endpoint symbol will be displayed).

Repeat for each sample.

At the end of sample measurement re-check the calibration of the instrument using one standard solution.



At any point during the calibration, should the instrument detect that the linearised slope calculated from the standard solutions is outside the limits of 0.015 to 19.99 a CAL OUT OF RANGE error will be displayed for approx. 2 seconds and the instrument will not perform the calibration.

Calibration mode can be exited at any time by moving to the EXIT option using the arrow keys and pressing .

3.18 DATALOGGING

STORING RESULTS

The STORE menu is used to store the displayed readings in any measurement mode. Select the STORE menu by using the arrow keys and pressing . When the STORE key is pressed the display will show the main and auxiliary readings, the previous menu options will be replaced by a new set containing the menu option ABORT NN (NN is the first available free location of the displayed reading).

To store the displayed reading at the current index number the  key should be pressed. If no key is pressed within 5 seconds the reading will be automatically stored in this location. The instrument will then return to the previously selected mode. If the reading is not to be stored, moving to the ABORT option using the arrow keys and pressing  will return the instrument to the previously selected mode without storing the reading. To store a reading in a specific location use the arrow keys to select the required location and press . If no other key is pressed within 5 seconds the reading will be automatically stored in this location. The instrument will then return to the previously selected mode.



NOTE: Automatic storage after 5 seconds is only instigated after the last key press. If a key is pressed and held down the timer is disabled until the key is released. At this stage the 5 second timer is re-initialised.

The non-volatile storage area has the facility to store 100 readings. If, however, an attempt is made to store a reading with all locations full, the highlighted message MEMORY FULL will be displayed, returning the highlighting to the ABORT option. If it is necessary to store the reading the location will have to be selected within the index option using the arrow keys.



NOTE: Storing a reading when the memory is full will overwrite any previous data stored in the selected location.

RECALLING STORED READINGS

To recall a stored reading select the RECALL menu option by using the arrow keys and then pressing . The display will update to the stored reading and the stored index number will be shown at the bottom of the display. If no stored reading is present the display will give the message NO RECORD STORED.

To select a specific stored reading, select the RECORD # option using the arrow keys and press . To select the required location use the arrow keys. The display will update to the selected reading. To exit the RECALL mode select the EXIT option and press . The instrument will return to the previous display.

CLEARING STORED READINGS

To clear an individual stored reading select the RECALL mode using the arrow keys and press . Select RECORD # by using the arrow keys and pressing ENT. Select the specific location to be deleted by using the arrow keys. Move to the DELETE menu option by using the arrow keys and press . The display will clear and update to show the message NO RECORD STORED, returning the highlighting to the location number.

Selecting the EXIT option and pressing  will return the instrument to the previous display.

To clear all stored readings select the CLEAR-ALL menu option using the arrow keys and press . The display will momentarily display the message DELETING... The display will then update to show the message ALL RECORDS DELETED.





Selecting the EXIT option and pressing  will return the instrument to the previous display.

DOWNLOADING STORED READINGS

To download or print stored readings press the  key from within the RECALL mode.

REAL TIME CLOCK SET UP

Real time clock set-up is performed by entering into the INSTRUMENT SETUP mode, selecting CLOCK SETUP using the arrow keys and pressing  .

Select the real time clock parameter to be changed using the arrow keys. Once highlighted adjustment of the parameter proceeds by pressing  . The first part of the parameter is highlighted and can be adjusted to the required value using the arrow keys. If further adjustment is required move the highlighted cursor to the next adjustable position using the  arrow key and adjust as required. Continue moving across the parameter until full adjustment has been made. to confirm new time or date press  or press the  key until the selected parameter is re-highlighted.

3.19 GOOD PRACTICE GUIDELINES

CONDUCTIVITY

1. The presence of particulate matter in the sample can lead to unstable and non-reproducible results. If necessary filter, or allow the particles to settle prior to immersion.
2. Ensure no air bubbles are trapped in the measuring cell. Gentle agitation of the cell should ensure that bubbles are purged.
3. The entire plate area must be immersed in the solution under test. The slots in the side of the sensor should be below the surface.
4. Whilst the 4-plate construction minimises the effect of fouling it is still advisable to clean the sensor if contamination is evident. This should be approached in a progressive manner, beginning with deionised water and progressing to other solvents or a soft air brush if the deposits persist. The carbon plates can be damaged and should not come into contact with anything which is likely to abrade their surface.
5. The temperature coefficient is very dependent on the solution being measured and its concentration level. The effect of temperature change on conductivity can be very significant, and if the temperature coefficient is not known it is wise to measure all samples at the same temperature.
6. Both the salinity and TDS modes display results which have been calculated from the measurement of conductivity. The salinity mode assumes that the major constituent responsible for the conductivity of the solution is sodium chloride. If significant quantities of other conductive species are present then the displayed results could be inaccurate. Likewise, the TDS mode assumes some knowledge of the electrolyte balance of the analyte. The EC ratio parameter found in the set up routine allows selection of a factor suitable for the solution under test. Most analysers not offering this option use a default value of 0.6.

pH ELECTRODES





The types of electrodes are many and various. For the majority of tests carried out on aqueous solutions with a reasonable ionic strength, at ambient temperatures and with limited use in strongly acidic or alkaline solutions, the standard glass or epoxy bodied electrode is ideal. For other applications a more suitable pH/reference electrode pair may be required, details or advice available on request.

The following general guidelines indicate the care and maintenance required for the three main groups of electrodes, i.e. combination, reference and pH.

- 1) After Use Rinse thoroughly with distilled water
Short Term Storage Immerse in pH4 buffer
Long Term Storage Fit wetting cap with pH7 buffer (combination)
Fit wetting cap with pH4 buffer (Reference/pH)
- 2) Electrodes should be stored:
 - a) away from direct sunlight
 - b) in a vertical position
 - c) within their specified temperature range
- 3) Always ensure the electrode is used within its specified temperature range. Ageing of electrodes used above their specified temperature is rapid and irreversible.
- 4) Ensure the level of the fill solution is above the internal elements in the electrode and that this level remains above the sample level in use.

- 5) DO NOT touch the sensitive glass pH membrane or reference junction during use. Excess droplets of solution may be removed by gently blotting with filter paper or tissue. DO NOT rub the electrode as this may induce an electrostatic charge.
- 6) Ensure no air bubbles are trapped at the bottom of the electrode. Removal of the air bubbles is possible by holding the electrode vertically and gently tapping the electrode body. Larger bubbles may be removed by shaking the electrode in a downward direction.
7. During use ensure the electrode is rinsed between each measurement to eliminate contamination of solutions.
8. Ensure that the side port/inlet is uncovered, especially during a long run of tests.

3.20 OPERATING THE INSTRUMENT WITH OPTIONAL STIRRER

The Model CDB-430 may be used with the optional bench and overhead stirrers. The stirrer should be connected to the instrument via the rear panel socket. Stirrer speed can be set by entering the SETUP and INSTRUMENT SETUP modes using the arrow keys and pressing . Select STIRRER OUTPUT (%) using the  arrow key and press  or .

Adjust the stirrer speed using the numeric keypad. Once set, select EXIT and press  to return to the main menu.

SECTION 4

MAINTENANCE

GENERAL

The Model CDB-430 is designed to give optimum performance with minimum maintenance. It is only necessary to keep the external surfaces clean and free from dust. To give added protection when the unit is not in use the unit should be disconnected from the mains supply and covered with the optional dust cover (544 008). For longer term storage or re-shipment it is recommended that the unit be returned to the original packing case.

CONDUCTIVITY

All conductivity cells should be thoroughly rinsed after use and stored in deionised water. Do not attempt to clean the surface of the plates as this could result in damage to the black platinised surface.

PROBE RE-PLATINISATION

Probe types CDE-430-1 and CDE-430-01 have a black platinum film on the cell plates. Deterioration of this film will be apparent either visually or functionally by causing a low reading to be obtained, particularly on conductive solutions.

Should this occur the following procedure should be carried out:

WARNING - THE CHEMICALS USED IN THIS PROCEDURE ARE CORROSIVE. ALL NORMAL SAFETY PRECAUTIONS SHOULD BE OBSERVED.

Solution

1.5 grammes Chloroplatinic Acid

0.015 grammes Lead Acetate

Deionised Water

The chemicals should be placed in a suitable container and made up to 50ml using the deionised water.

PROCEDURE

- 1) Connect the probe to the rear panel platinising socket.
- 2) Rinse the cell thoroughly in deionised water to ensure it is clean and free from contamination. In extreme cases rinsing in Chromic Acid may be necessary.
- 3) Completely immerse the plates in the platinising solution.
- 4) The probe should be left in the solution for a period of no greater than 10 minutes. At the end of this time the plates should have an even black appearance.
- 5) Carefully remove the cell from the platinising solution and wash in deionised water.
- 6) Completely immerse the plates in a 1M Sulphuric Acid solution and leave for a period of 10 minutes.
- 7) Rinse the probe in deionised water and recalibrate the probe.

CLEANING/RE-CONDITIONING OF GLASS pH ELECTRODES

For general purpose use combination electrodes can be cleaned with a mild detergent solution or a commercial glass cleaning solution (provided these are not strongly acidic). The electrode surface should be wiped with a clean cloth soaked in the cleaning agent, and/or allow the membrane to stand in the solution until clean. Rinse and repeat as necessary.

TABLE FOR CLEANING OF GLASS ELECTRODES

NOTE: Epoxy bodied electrodes should not be cleaned with aggressive solvents.

DEPOSIT	CLEANING AGENT
General deposits	Mild detergent solution
Inorganic coatings	Commercial glass cleaning solution (not strongly acidic)
Metal compounds	Acid solution, not stronger than 1M
Oil/Grease	Complexing agent (EDTA) or suitable solvent
Resins/Lignins	Acetone, alcohol or detergent (not strongly alkaline)
Proteins (blood, etc)	Enzyme solutions e.g. pepsin in 0.1M HCl
Stubborn deposits	Weak hydrogen peroxide solution, sodium hypochlorite solution or domestic bleach

Electrodes which have been allowed to dry out (often indicated by a hard, dry deposit of KCl crystals on the electrode body) should be rehabilitated by soaking overnight in warm distilled water.

SECTION 5

OPTIONAL ACCESSORIES

The following list of items are available for use with the Model CDB-430:

PRT-431	40 Column Printer	Stirrers	
060 287	Paper Roll	555 001	Bench Stirrer
060 288	Printer Ribbon	556 001	Overhead Stirrer
PHRS-320	Jensoft Software 3½" disk		
542 009	Interface Cable Kit		

Power Supplies

CDB-430-PW-UK	U.K. 230V Power Supply
CDB-430-PW-EC	European 230V Power Supply
CDB-430-PW	U.S. 115V Power Supply
CDB-430-PW-230	230V leaded Power Supply

Conductivity Electrodes

CDE-430-1	Conductivity Cell with ATC K=1
CDE-430-01	Conductivity Cell with ATC K=0.1
CDE-430-1F	Conductivity Cell with ATC K=1 (flow through)
CE-430-01-EP	Conductivity Cell with ATC K=0.1 Epoxy
CDE-430-1-EP	Conductivity Cell with ATC K=1 Epoxy
CDE-430-10-EP	Conductivity Cell with ATC K=10 Epoxy

SECTION 6

INTERFACING

Analog

All units are provided with 2 x 4mm sockets, marked as ANALOG OUT, on the rear panel.

The CDB-430 allows the recorder output sensitivity to be fixed, so that it is independent of the display auto-ranging function.

The voltage is proportional to the displayed primary reading. In mV mode there is a direct relationship i.e. 1mV on the display = 1mV from the analog output.

In pH mode 1mV = 0.01pH i.e. 7.000pH = 700mV, 2.345pH = 234mV.

In Conductivity mode the user can set the sensitivity of the analog output using the REC mV menu option. From INSTRUMENT SETUP mode on the CDB-430, place the cursor on the REC 1mV menu option and then press the enter key. The arrow keys can then be used to scroll through the various sensitivity options for the recorder output, as shown below:

Instrument Setup from Conductivity Mode

0.001 μ S
0.01 μ S
0.1 μ S
0.001mS
0.01mS
0.1mS
0.001S
0.01S

Instrument Setup from TDS Mode

0.001mg l^{-1}
0.01mg l^{-1}
0.1mg l^{-1}
1mg l^{-1}
0.01gl l^{-1}
0.1gl l^{-1}
1gl l^{-1}

For example, if you set the recorder level (REC 1mV) to 0.001mS, then a displayed reading of 1.245mS will give a recorder output of:

$$\frac{1.245 \times 10^{-3} \times 1\text{mV}}{0.001 \times 10^{-3}} = 1245\text{mV}$$

Similarly, if the reading changes to 10.35 μ S, then the recorder output will give:

$$\frac{10.35 \times 10^{-6} \times 1\text{mV}}{0.001 \times 10^{-3}} = 10\text{mV}$$

Karl Fischer

A polarised Karl Fischer output is provided. Karl Fischer titrations are enabled by the provision of a 10 μ A polarising current output.

RS232

The Model CDB-430 emulates data communicating equipment, which allows direct connection to the signals of data terminal equipment, such as personal computers and serial printers.

The Bi-directional RS232 interface is available on the rear panel 25 way D type connector.

The connections are as follows:

TXD 2	- INPUT TO CDB-430
RXD 3	- OUTPUT FROM CDB-430
RTS 4	- LINKED TO CTS
CTS 5	- LINKED TO RTS
DSR 6	- OUTPUT FROM CDB-430
DCD 8	- OUTPUT FROM CDB-430
DTR 20	- INPUT TO CDB-430 (must be active)
GND 7	

Suggested interconnections are detailed below:

CDB-430		IBM PC XT (25 pin "D")	
TXD 2	_____	2	TXD (From PC)
RXD 3	_____	3	RXD (To PC)
RTS 4	_____	4	RTS (From PC)
CTS 5	_____	5	CTS (To PC)
DSR 6	_____	6	DSR (To PC)
DCD 8	_____	8	DCD (To PC)
DTR 20	_____	20	DTR (From PC)
GND 7	_____	7	GND

CDB-430		IBM PC XT (9 pin "D")	
TXD 2	_____	3	TXD (From PC)
RXD 3	_____	2	RXD (To PC)
RTS 4	_____	7	RTS (From PC)
CTS 5	_____	8	CTS (To PC)
DSR 6	_____	6	DSR (To PC)
DCD 8	_____	1	DCD (To PC)
DTR 20	_____	4	DTR (From PC)
GND 7	_____	5	GND

The RS232 communications parameters on the computer or printer need to be set to match those of the Model CDB-430, as detailed below:

1200 Baud
7 Data Bits
Odd Parity
1 Stop Bit

The Model CDB-430 supports both hardware (DTR/DSR) flow control and software XON/XOFF flow control.

Pressing the PRINT key outputs from the RS232 interface.

Sending an ASCII "D" to the CDB-430 causes a printout of the current displayed reading plus sample number.

Sending an ASCII "C" causes a printout of the last calibration parameters (same as printout after performing a calibration).

Sending an ASCII "P" causes downloading of stored readings.

ALARM CONNECTIONS

Each sensor channel has independent alarms. When a reading goes outside the alarm limits, the CDB-430 activates an open collector transistor alarm output to indicate that a low or high alarm limit has been exceeded. Each transistor can sink up to 0.5A. The maximum no load voltage for each transistor is 50V dc.

The alarm transistor output connections are available on the 25 pin D socket:

pin 12 sensor 1 (pH) open collector transistor low alarm output
pin 13 sensor 1 (pH) open collector transistor high alarm output
pin 10 sensor 2 (Cond) open collector transistor low alarm output
pin 9 sensor 2 (Cond) open collector transistor high alarm output
pin 17 ground connection for alarms

Both outputs will sink current to the common line (pin 7) i.e. the emitters of both alarm transistors are connected to pin 7.

NOTE: The open circuit voltage on pin 12 or pin 13 must not exceed 50V d.c. with respect to pin 7.

EC Declaration of Conformity

EN 50081-1:1992 Electromagnetic compatibility - Generic emission standard

EN 50082-1:1992 Electromagnetic compatibility - Generic immunity standard (Performance criterion B)

EN 61010-1:1993 Safety requirements for electrical equipment for measurement, control and laboratory use

Following the provision of:

EMC Directive - 89/336/EEC and Low Voltage Directive - 73/23/EEC

NOTES:

NOTES:

WARRANTY/DISCLAIMER

OMEGA ENGINEERING, INC. warrants this unit to be free of defects in materials and workmanship for a period of **25 months** from date of purchase. OMEGA's WARRANTY adds an additional one (1) month grace period to the normal **two (2) year product warranty** to cover handling and shipping time. This ensures that OMEGA's customers receive maximum coverage on each product.

If the unit malfunctions, it must be returned to the factory for evaluation. OMEGA's Customer Service Department will issue an Authorized Return (AR) number immediately upon phone or written request. Upon examination by OMEGA, if the unit is found to be defective, it will be repaired or replaced at no charge. OMEGA's WARRANTY does not apply to defects resulting from any action of the purchaser, including but not limited to mishandling, improper interfacing, operation outside of design limits, improper repair, or unauthorized modification. This WARRANTY is VOID if the unit shows evidence of having been tampered with or shows evidence of having been damaged as a result of excessive corrosion; or current, heat, moisture or vibration; improper specification; misapplication; misuse or other operating conditions outside of OMEGA's control. Components in which wear is not warranted, include but are not limited to contact points, fuses, and triacs.

OMEGA is pleased to offer suggestions on the use of its various products. However, OMEGA neither assumes responsibility for any omissions or errors nor assumes liability for any damages that result from the use of its products in accordance with information provided by OMEGA, either verbal or written. OMEGA warrants only that the parts manufactured by it will be as specified and free of defects. OMEGA MAKES NO OTHER WARRANTIES OR REPRESENTATIONS OF ANY KIND WHATSOEVER, EXPRESS OR IMPLIED, EXCEPT THAT OF TITLE, AND ALL IMPLIED WARRANTIES INCLUDING ANY WARRANTY OF MERCHANTABILITY AND FITNESS FOR A PARTICULAR PURPOSE ARE HEREBY DISCLAIMED. LIMITATION OF LIABILITY: The remedies of purchaser set forth herein are exclusive, and the total liability of OMEGA with respect to this order, whether based on contract, warranty, negligence, indemnification, strict liability or otherwise, shall not exceed the purchase price of the component upon which liability is based. In no event shall OMEGA be liable for consequential, incidental or special damages.

CONDITIONS: Equipment sold by OMEGA is not intended to be used, nor shall it be used: (1) as a "Basic Component" under 10 CFR 21 (NRC), used in or with any nuclear installation or activity; or (2) in medical applications or used on humans. Should any Product(s) be used in or with any nuclear installation or activity, medical application, used on humans, or misused in any way, OMEGA assumes no responsibility as set forth in our basic WARRANTY/DISCLAIMER language, and, additionally, purchaser will indemnify OMEGA and hold OMEGA harmless from any liability or damage whatsoever arising out of the use of the Product(s) in such a manner.

RETURN REQUESTS/INQUIRIES

Direct all warranty and repair requests/inquiries to the OMEGA Customer Service Department. BEFORE RETURNING ANY PRODUCT(S) TO OMEGA, PURCHASER MUST OBTAIN AN AUTHORIZED RETURN (AR) NUMBER FROM OMEGA'S CUSTOMER SERVICE DEPARTMENT (IN ORDER TO AVOID PROCESSING DELAYS). The assigned AR number should then be marked on the outside of the return package and on any correspondence.

The purchaser is responsible for shipping charges, freight, insurance and proper packaging to prevent breakage in transit.

FOR **WARRANTY** RETURNS, please have the following information available BEFORE contacting OMEGA:

1. Purchase Order number under which the product was PURCHASED,
2. Model and serial number of the product under warranty, and
3. Repair instructions and/or specific problems relative to the product.

FOR **NON-WARRANTY** REPAIRS, consult OMEGA for current repair charges. Have the following information available BEFORE contacting OMEGA:

1. Purchase Order number to cover the COST of the repair,
2. Model and serial number of the product, and
3. Repair instructions and/or specific problems relative to the product.

OMEGA's policy is to make running changes, not model changes, whenever an improvement is possible. This affords our customers the latest in technology and engineering.

OMEGA is a registered trademark of OMEGA ENGINEERING, INC.

© Copyright 2016 OMEGA ENGINEERING, INC. All rights reserved. This document may not be copied, photocopied, reproduced, translated, or reduced to any electronic medium or machine-readable form, in whole or in part, without the prior written consent of OMEGA ENGINEERING, INC.

Where Do I Find Everything I Need for Process Measurement and Control? **OMEGA...Of Course!** *Shop online at omega.comSM*

TEMPERATURE

- ☑ Thermocouple, RTD & Thermistor Probes, Connectors, Panels & Assemblies
- ☑ Wire: Thermocouple, RTD & Thermistor
- ☑ Calibrators & Ice Point References
- ☑ Recorders, Controllers & Process Monitors
- ☑ Infrared Pyrometers

PRESSURE, STRAIN AND FORCE

- ☑ Transducers & Strain Gages
- ☑ Load Cells & Pressure Gages
- ☑ Displacement Transducers
- ☑ Instrumentation & Accessories

FLOW/LEVEL

- ☑ Rotameters, Gas Mass Flowmeters & Flow Computers
- ☑ Air Velocity Indicators
- ☑ Turbine/Paddlewheel Systems
- ☑ Totalizers & Batch Controllers

pH/CONDUCTIVITY

- ☑ pH Electrodes, Testers & Accessories
- ☑ Benchtop/Laboratory Meters
- ☑ Controllers, Calibrators, Simulators & Pumps
- ☑ Industrial pH & Conductivity Equipment

DATA ACQUISITION

- ☑ Data Acquisition & Engineering Software
- ☑ Communications-Based Acquisition Systems
- ☑ Plug-in Cards for Apple, IBM & Compatibles
- ☑ Data Logging Systems
- ☑ Recorders, Printers & Plotters

HEATERS

- ☑ Heating Cable
- ☑ Cartridge & Strip Heaters
- ☑ Immersion & Band Heaters
- ☑ Flexible Heaters
- ☑ Laboratory Heaters

ENVIRONMENTAL MONITORING AND CONTROL

- ☑ Metering & Control Instrumentation
- ☑ Refractometers
- ☑ Pumps & Tubing
- ☑ Air, Soil & Water Monitors
- ☑ Industrial Water & Wastewater Treatment
- ☑ pH, Conductivity & Dissolved Oxygen Instruments