



DP18 Series

Models DP18-M1F

RTD Input Temperature Indicator

INSTRUCTION SHEET

M2314/0995



TEMPERATURE METERS FOR 100 Ω Pt RTD (Resistance Temperature Detector) INPUT DIN 43760, $\alpha = 0.00385$.

PROVIDED WITH BUILT-IN CURRENT EXCITATION AND LINEARIZATION FOR DIRECT READOUT IN DEGREES FAHRENHEIT.

ACCEPT SENSORS WITH 2 OR 3 WIRES AND AUTOMATIC MAXIMUM LEAD RESISTANCE COMPENSATION IS 10 Ω.

THIS MODEL CAN ACCEPT ADDITIONAL BOARDS FOR ANALOG OUTPUT AND UPPER BOARDS FOR DIGITAL OR CONTROL OUTPUTS.

SPECIFICATIONS

DISPLAYS 3½ digits, 7 segment, red LED
 HEIGHT 0.56" (14.2 mm.)
 SYMBOLS ± 1.8.8.8
 DECIMAL POINTS Selectable by jumpers
 OVERRANGE INDICATION Display flashes

INPUT CONFIGURATION Bipolar single
 ZERO Automatic
 SPAN ADJUSTMENT ± 5 %

CONVERTER Dual-slope, average value
 POLARITY Automatic ±
 SIGNAL INTEGRATION PERIOD 80 ms.
 READ RATE 3.12 / sec.
 RANGES See table, fig. 3
 HOLD Optional

NOISE REJECTION NMR 50 dB. 50/60 Hz.
 ACCURACY See table, fig. 3
 WARMUP TO RATED ACCURACY 2 minutes
 SPAN TEMPCO 150 ppm
 ZERO TEMPCO 2.5 μV/°C.

OPERATING TEMPERATURE 0 to 50 °C (32 to 122 °F)
 STORAGE TEMPERATURE -40 to 80 °C (-40 to 176 °F)
 WEIGHT 310 gr. (0.68 lb)
 CASE MATERIAL ABS, DIN 43700, black color
 STANDARD POWER 110 Vac. ± 10 %, 50/60 Hz.
 POWER CONSUMPTION 5.5 VA for AC.
 ELECTRICAL CONNECTIONS Push-in cable connectors
 BURN-IN 24 h.

FIG. 1

FRONT VIEW

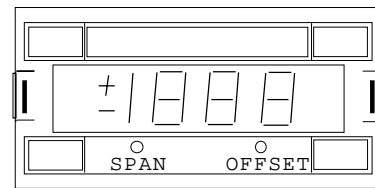

SPAN: ADJUST THE MAXIMUM READING.

OFFSET: NOT IN SERVICE

SPAN ADJUSTMENT IS ACCESSIBLE BEHIND THE LOW DOOR.

FIG. 2

REAR VIEW

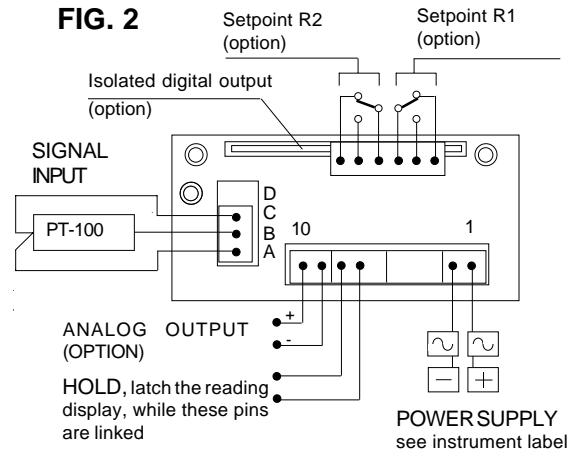

3 WIRE CONNECTION

FIG. 3

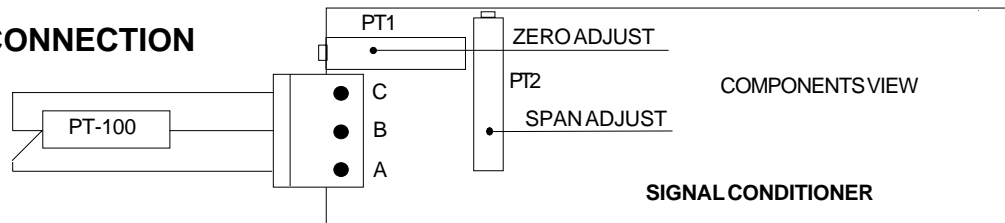

2 WIRE CONNECTION

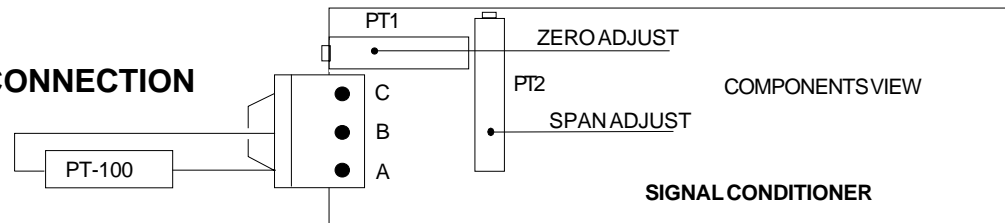

MODEL	TEMPERATURE RANGE	ACCURACY	RESOLUTION	MAXIMUM COMPENSATION
DP18-M1F	-200 to +400 °F	1 °F ±1	1 °F	10 Ω



OPTIONS AND POWER SUPPLIES AVAILABLE FOR DP18 Series

CONTROL OUTPUT/COMMUNICATIONS OPTIONS
Select a maximum of one option from each column

POWER SUPPLY OPTIONS

Table with 4 columns: OPTION, DESCRIPTION, OPTION, DESCRIPTION. Lists control output options like BCD, R1, R2, APH1, 232, A01, A02, A03, APH2.

Table with 4 columns: OPTION, POWER, OPTION, POWER. Lists power supply options like 230, STD, 24, 48.

SELECTION OF : DECIMAL POINTS AND SPECIAL OPTIONS

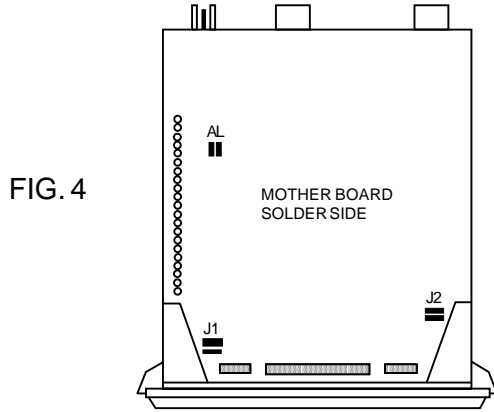

JUMPERS SELECTION FOR SPECIAL OPTIONS

AL: OPEN ONLY WHEN ALARM SETPOINT CARD OPTION IS ADDED
J1: OPEN TO ELIMINATE THE LEAST-SIGNIFICANT DIGIT (LSD)
J2: OPEN TO ELIMINATE THE INDICATION ±

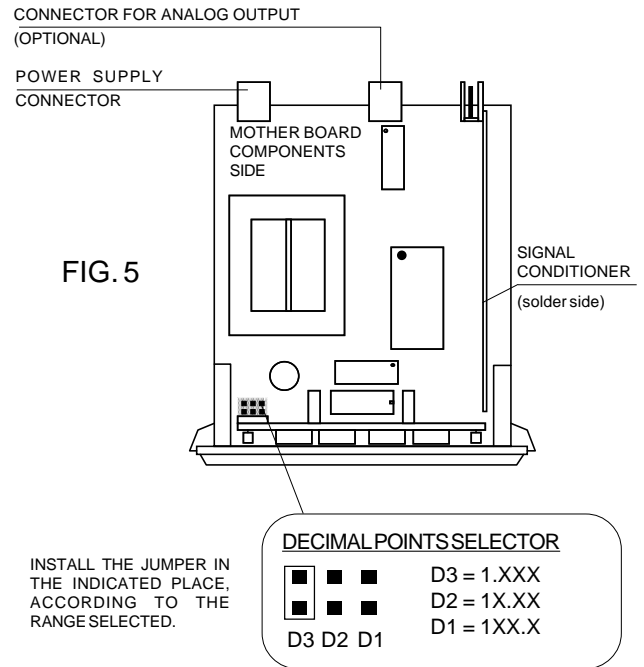

INSTALL THE JUMPER IN THE INDICATED PLACE, ACCORDING TO THE RANGE SELECTED.

DECIMAL POINTS SELECTOR

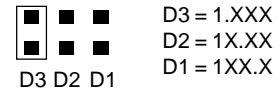

MECHANICAL DIMENSIONS mm (in)

FIG. 6

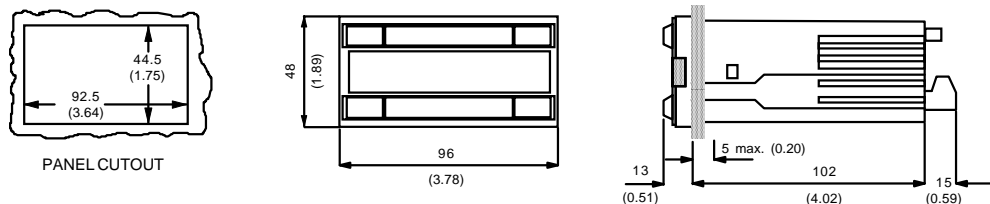

WARRANTY/DISCLAIMER

OMEGA warrants this unit to be free of defects in materials and workmanship and to give satisfactory service for a period of 13 months from date of purchase.

OMEGA is pleased to offer suggestions on the use of its various products. However OMEGA neither assumes responsibility for any omissions or errors nor assumes liability for any damages that result from the use of its products.

LIMITATION OF LIABILITY: The remedies of purchaser set forth herein are exclusive and the total liability of OMEGA with respect to this order, whether based on contract, warranty, negligence, indemnification, strict liability or otherwise, shall not exceed the purchase price of the component upon which liability is based.

CONDITIONS: Equipment sold by OMEGA is not intended to be used, nor shall it be used: (1) as a "Basic Component" under 10 CFR 21 (NRC), used in or with any nuclear installation or activity;



Servicing USA and Canada: Call OMEGA Toll Free USA Canada

One Omega Drive, Box 4047 Stamford, CT 06907-0047 Telephone: (203) 359-1660 FAX: (203) 359-7700

796 Bergar Laval (Quebec) H7L 5A1 Telephone: (514) 856-6928 FAX: (514) 856-6886

Servicing Europe: One OMEGA Drive, River Bend Technology Centre

Northbank, Irlam, Manchester M44 5EX, England Telephone: 44 (161) 777-6611 FAX: 44 (161) 777-6622

RETURN REQUESTS/INQUIRIES

Direct all warranty and repair requests/inquiries to the OMEGA ENGINEERING Customer Service Department. BEFORE RETURNING ANY PRODUCT(S) TO OMEGA, PURCHASER MUST OBTAIN AN AUTHORIZED RETURN (AR) NUMBER FROM OMEGA'S CUSTOMER SERVICE DEPARTMENT.

FOR WARRANTY RETURNS, please have the following information available BEFORE contacting OMEGA:

- 1. P.O. number under which the product was PURCHASED.
2. Model and serial number of the product under warranty, and
3. Repair instructions and/or specific problems relative to the product.

FOR NON-WARRANTY REPAIRS, consult OMEGA for current repair charges. Have the following information available BEFORE contacting OMEGA:

- 1. P.O. number to cover the COST of the repair,
2. Model and serial number of product, and
3. Repair instructions and/or specific problems relative to the product.

OMEGA's policy is to make running changes, not model changes, whenever an improvement is possible. This affords our customers the latest in technology and engineering.

OMEGA is a registered trademark of OMEGA ENGINEERING, INC. © Copyright 1998 OMEGA ENGINEERING, INC. All rights reserved. This documentation may not be copied, photocopied, reproduced, translated, or reduced to any electronic medium or machine-readable form, in whole or in part, without prior written consent of OMEGA ENGINEERING, INC.