

1 YEAR
WARRANTY

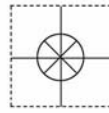

User's Guide



Shop online at

omega.com[®]

Ω OMEGA[®]

omega.com

e-mail: info@omega.com

*For latest product manuals:
omegamanual.info*

ISO 9001
CERTIFIED
CORPORATE QUALITY

STAMFORD, CT

ISO 9001
CERTIFIED
CORPORATE QUALITY

MANCHESTER, UK

LVCN-120, -130 & -140 Series Remote Relay Controllers



OMEGAnet® Online Service
omega.com

Internet e-mail
info@omega.com

Servicing North America:

U.S.A.:
ISO 9001 Certified

Omega Engineering, Inc., One Omega Drive, P.O. Box 4047
Stamford, CT 06907-0047 USA

Toll Free: 1-800-826-6342
FAX: (203) 359-7700

TEL: (203) 359-1660
e-mail: info@omega.com

Canada:

976 Bergar
Laval (Quebec), Canada H7L 5A1
Toll-Free: 1-800-826-6342
FAX: (514) 856-6886

TEL: (514) 856-6928
e-mail: info@omega.ca

For immediate technical or application assistance:

U.S.A. and Canada: Sales Service: 1-800-826-6342/1-800-TC-OMEGA®
Customer Service: 1-800-622-2378/1-800-622-BEST®
Engineering Service: 1-800-872-9436/1-800-USA-WHEN®

Mexico:

En Español: 001 (203) 359-7803
info@omega.com.mx

FAX: (001) 203-359-7807
e-mail: espanol@omega.com

Servicing Europe:

Benelux:

Managed by the United Kingdom Office
Toll-Free: 0800 099 3344
FAX: +31 20 643 46 43

TEL: +31 20 347 21 21
e-mail: sales@omega.nl

Czech Republic:

Frystatska 184
733 01 Karviná, Czech Republic
Toll-Free: 0800-1-66342
FAX: +420-59-6311114

TEL: +420-59-6311899
e-mail: info@omegashop.cz

France:

Managed by the United Kingdom Office
Toll-Free: 0800 466 342
FAX: +33 (0) 130 57 54 27

TEL: +33 (0) 161 37 29 00
e-mail: sales@omega.fr

Germany/Austria:

Daimlerstrasse 26
D-75392 Deckenpfronn, Germany
Toll-Free: 0 800 6397678
FAX: +49 (0) 7056 9398-29

TEL: +49 (0) 7059 9398-0
e-mail: info@omega.de

United Kingdom:
ISO 9001 Certified

OMEGA Engineering Ltd.
One Omega Drive, River Bend Technology Centre, Northbank
Irlam, Manchester M44 5BD England
Toll-Free: 0800-488-488
FAX: +44 (0)161 777-6622

TEL: +44 (0)161 777-6611
e-mail: sales@omega.co.uk

It is the policy of OMEGA Engineering, Inc. to comply with all worldwide safety and EMC/EMI regulations that apply. OMEGA is constantly pursuing certification of its products to the European New Approach Directives. OMEGA will add the CE mark to every appropriate device upon certification.

The information contained in this document is believed to be correct, but OMEGA accepts no liability for any errors it contains, and reserves the right to alter specifications without notice.

WARNING: These products are not designed for use in, and should not be used for, human applications.

The LVCN-120/-130/-140 Series Controllers are general-purpose level controllers offered in three configurations for pump and valve control. The LVCN-140 Series features a single 10A SPDT relay output and can accept one level sensor as an input. The LVCN-130 Series features a single 10A SPDT latching relay output and can accept one or two level sensor(s) as an input. This package is ideal for the automatic filling or emptying of a tank. The LVCN-120 Series features both a single 10A SPDT and a single 10A Latching SPDT relay. This package allows for a three-input system that can perform a automatic operations (fill or empty) and an alarm operation (high or low). The LVCN-120 series can also be a two-input controller that can perform dual alarms (2-high, 2-low or 1-high, 1-low). Package either controller series with level switch sensors and fittings.

Features

- Fail-Safe relay control of pumps, valves or alarms with a 0 to 60 second delay
- Optional flashing alarm brings immediate attention to level alarm conditions.
- Polypropylene enclosure can be DIN rail mounted or back panel mounted.
- Easy setup with LED indicators for sensor(s), power and relay status.
- Invert switch changes relay state from NO to NC without rewiring.
- AC powered

Table of Contents

Specifications: 4

Dimensions:..... 4

Safety Precautions: 5

Make a Fail-Safe System: 6

Components:..... 6

Getting Started:..... 7

Features of the Single Input High or Low Relay:..... 7

Features of the Dual Input Automatic Fill/Empty Relay: 7

Guide to Controls: 8

Electrical..... 9

Connecting Switches to Input Terminals: 9

VAC Power Input Wiring: 9

Relay Input Wiring: 10

Changing from 120 to 240 VAC..... 10

Installation 11

Application Exmaples..... 12

Low Level Alarm:..... 12

High Level Alarm: 12

LED Indication: 12

Automatic Fill: 13

Automatic Empty: 13

Appendix 14

Controller Logic..... 14

Relay Latching Logic Table (LVCN-120 & -130 Series only)..... 14

Troubleshooting..... 14

- Supply voltage: 120 / 240 VAC, 50 - 60 Hz.
- Consumption: 5 Watts max.
- Sensor inputs: (1) level switch
(LVCN-130 series only) (1 or 2) level switches
(LVCN-120 series only) (1, 2 or 3) level switches
- Sensor supply: 13.5 VDC @ 27 mA
- LED indication: Sensor, relay & power status
- Contact type: (1) SPDT Relay
(LVCN-130 series only) (1) SPDT Relay, Latched
(LVCN-120 series only) (2) SPDT Relays, only 1 Latched
- Contact rating: 250 VAC, 10A
- Contact output: Selectable NO or NC
- Contact delay: 0 to 60 seconds
- Contact latch: Select On/Off
(LVCN-120 & LVCN-130 series only)

- Electronics temp.: F: -40° to 158°
C: -40° to 70°
- Enclosure rating: 35mm DIN (EN 50 022)
- Enclosure material: PP (U.L. 94 VO)
- Fail safety: Power fail-safe
- CE compliance: EN 61326 EMC
EN 61010-1 Safety

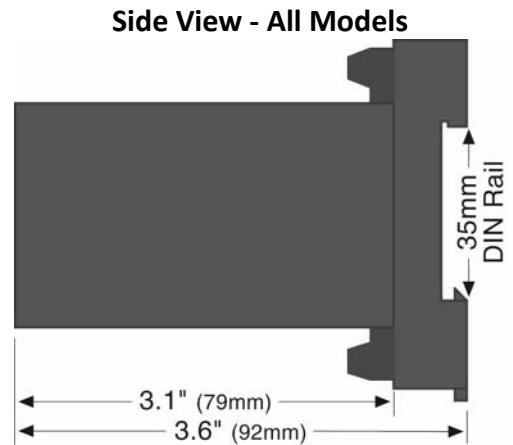
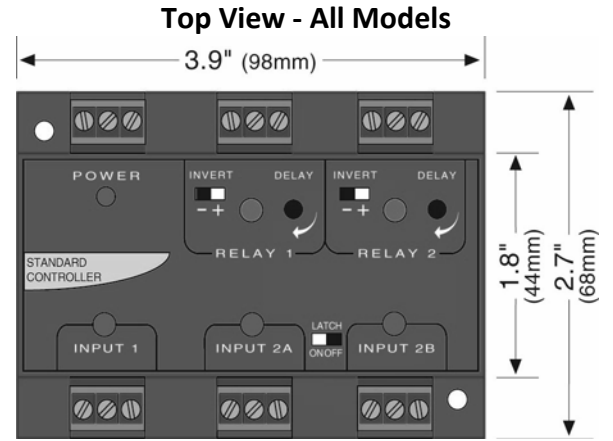

LVCN-140 series faceplate: 1 sensor input, 1 relay output.

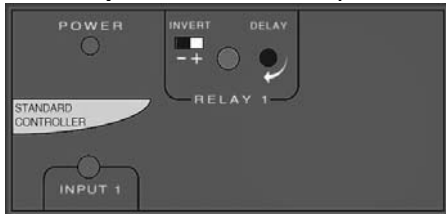

LVCN-130 series faceplate: 2 sensor inputs, 1 relay output.
The relay included is a latching relay.

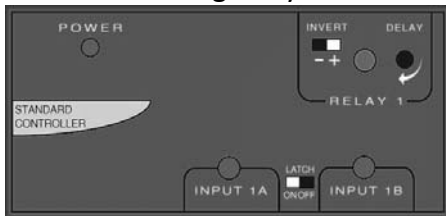

LVCN-120 series faceplate: 3 sensor input, 2 relay outputs.
One relay is latching and the other is a single input relay.

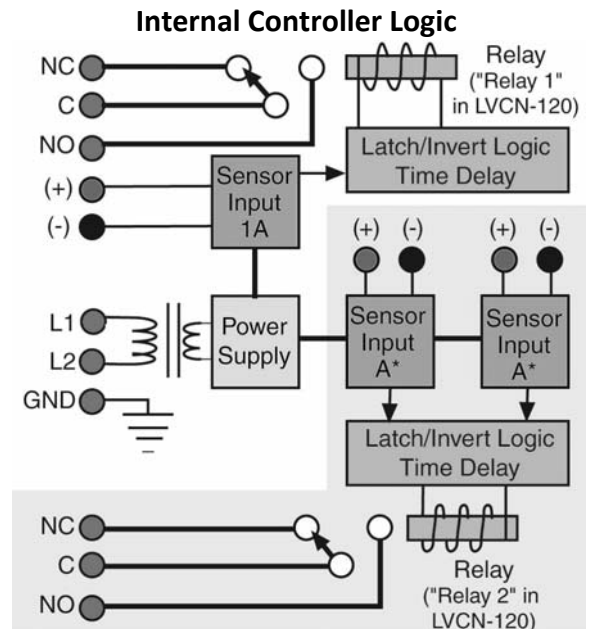

- ⚠ **About This Manual:** PLEASE READ THE ENTIRE MANUAL PRIOR TO INSTALLING OR USING THIS PRODUCT. This manual includes information on three different models of Remote Relay Controllers from OMEGA ENGINEERING: LVCN-120, LVCN-130 and LVCN-140 series. Many aspects of installation and use are similar between the three models. Where they differ, the manual will note it. Please refer to the part number on the controller you have purchased as you read.
- ⚠ **User's Responsibility for Safety:** OMEGA ENGINEERING manufactures several models of controller, with different mounting and switching configurations. It is the user's responsibility to select a controller model that is appropriate for the application, install it properly, perform tests of the installed system, and maintain all components.
- ⚠ **Electrical Shock Hazard:** It is possible to contact components on the controller that carry high voltage, causing serious injury or death. All power to the controller and the relay circuit(s) it controls should be turned OFF prior to working on the controller. If it is necessary to make adjustments during powered operation, use extreme caution and use only insulated tools. Making adjustments to powered controllers is not recommended. Wiring should be performed by qualified personnel in accordance with all applicable national, state and local electrical codes.
- ⚠ **Flammable or Explosive Applications:** *The entire LVCN-120/-130/-140 series remote mount controllers should not be used with explosive or flammable liquids, which require an intrinsically safe or explosion proof rating.* If you are unsure of the suitability of a controller for your installation, consult your Omega Engineering representative for further information.
- ⚠ **Install In a Dry Location:** The controller housing is not designed to be immersed. When installed properly, the controller is not designed to be immersed. It should be mounted in such a way that it does not normally come into contact with liquid. Refer to an industry reference to ensure that compounds that may splash onto the controller housing will not damage it. Such damage is not covered by the warranty.
- ⚠ **Relay Contact Rating:** The relay is rated for a 10 amp resistive load. Many loads (such as a motor during start-up or incandescent lights) are reactive and may have an inrush current characteristic that may be 10 to 20 times their steady-state load rating. The use of a contact protection circuit may be necessary for your installation if the 10 amp rating does not provide an ample margin for such inrush currents.

Make a Fail-Safe System: Design a fail-safe system that accommodates the possibility of relay or power failure. If power is cut off to the controller, it will de-energize the relay. Make sure that the de-energized state of the relay is the safe state in your process. For example, if controller power is lost, a pump filling a tank will turn off if it is connected to the Normally Open side of the relay.

While the internal relay is reliable, over the course of time relay failure is possible in two modes: under a heavy load the contacts may be “welded” or stuck into the energized position, or corrosion may buildup on a contact so that it will not complete the circuit when it should. In critical applications, redundant backup systems and alarms must be used in addition to the primary system. Such backup systems should use different sensor technologies where possible.

While this manual offers some examples and suggestions to help explain the operation of OMEGA ENGINEERING products, such examples are for information only and are not intended as a complete guide to installing any specific system.

Components:

- LVCN-140 - Single Input High or Low Relay Controller
- LVCN-140-CE - Single Input High or Low Relay Controller w/ CE
- LVCN-130 - Dual Input Automatic Fill/Empty Relay Controller
- LVCN-130-CE - Dual Input Automatic Fill/Empty Relay Controller w/ CE
- LVCN-120 - Three Input Auto Fill/Empty Relay Controller with Single Input High or Low Relay
- LVCN-120-CE - Three Input Auto Fill/Empty Relay Controller with Single Input High or Low Relay w/ CE
- Owner’s Manual

Features of a Single Input High or Low Relay: Single Input Relays (LVCN-140 series, LVCN-130 series with latch turned OFF and LVCN-120 series) are designed to receive a signal from a single liquid sensor. It turns its internal relay ON or OFF (as set by the invert switch) in response to the presence of liquid, and changes the relay status back again when the sensor is dry.

High Alarm:

Invert is OFF. Relay will energize when the switch becomes Wet and will de-energize when the switch becomes Dry (out of liquid).

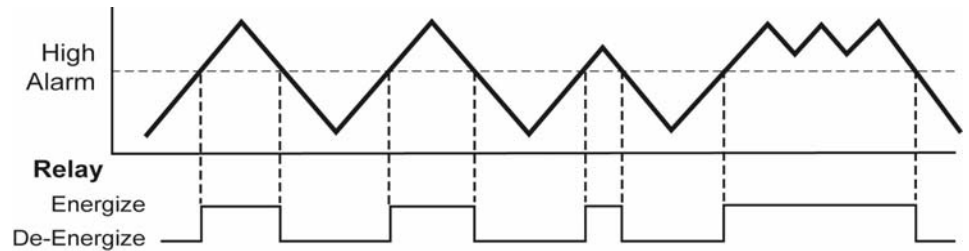

Low Alarm:

Invert is ON. Relay will energize when the switch becomes Dry (out of liquid) and will de-energize when the switch becomes Wet.

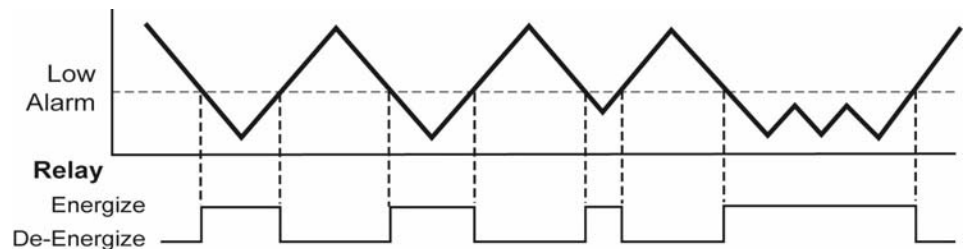

Single Input Relays may be used with almost any kind of sensor signal: current sensing or contact closure. The relay is a single pole, double throw type; the controlled device can be connected to either the normally open or normally closed side of the relay. A time delay from 0 to 60 seconds can be set before the relay responds to the sensor input. Typical applications for Single Input Relays are high level or low level switch/alarm operations (opening a drain valve whenever liquid level rises to a sensor point) and leak detection (sounding an alarm when a leak is detected, etc.).

Features of a Dual Input Automatic Fill/Empty Relay: The Dual Input Automatic Fill/Empty Relay (LVCN-120 and LVCN-130 series only) is designed to receive signals from two liquid sensors. It turns its internal relay ON or OFF (as set by the invert switch) in response to the presence of liquid on both sensors, and changes the relay status back again when both sensors are dry.

Automatic Empty:

Latch is ON & Invert is OFF. Relay will energize when level reaches high switch (both switches are wet). Relay will de-energize when level is below the bottom switch (both switches are dry).

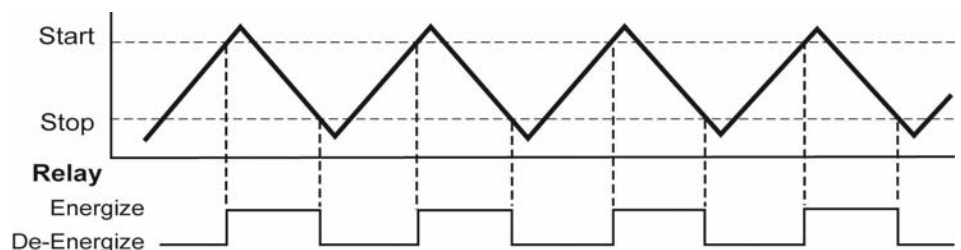

Automatic Empty:

Latch is ON & Invert is ON. Relay will energize when level is below the bottom switch (both switches are dry). Relay will de-energize when level reaches high switch (both switches are wet).

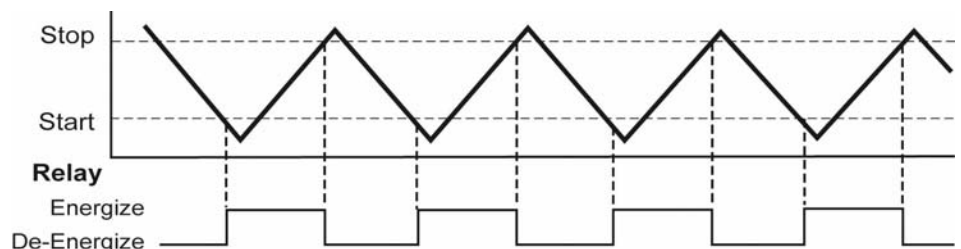

The Dual Input Automatic Fill/Empty Relay may be used with almost any kind of sensor signal: current sensing or contact closure. The relay is a single pole, double throw type; the controlled device can be connected to either the normally open or normally closed side of the relay. A time delay from 0 to 60 seconds can be set before the relay responds to the sensor input. Typical applications for Dual Input Relays are automatic filling (starting fill pump at a low level and stopping pump at a high level) or automatic emptying operations (opening a drain valve at a high level and closing valve at low level).

Guide to Controls: Below is a listing and the location of the different components for the controller:

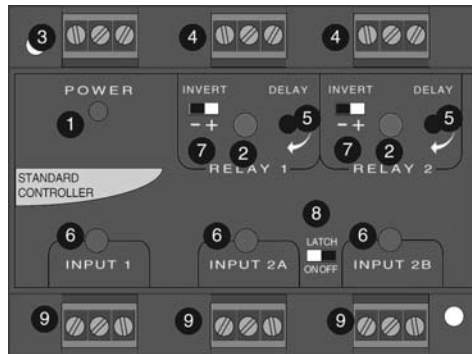

1. **Power indicator:** This green LED lights when AC power is ON.
2. **Relay indicator:** This red LED will light whenever the controller energizes the relay, in response to the proper condition at the sensor input(s) and after the time delay.
3. **AC Power terminals:** Connection of 120 VAC power to the controller. The setting may be changed to 240 VAC if desired. This requires changing internal jumpers; this is covered in the Installation section of the manual. Polarity (neutral and hot) does not matter.
4. **Relay terminals (NC, C, NO):** Connect the device you wish to control (pump, alarm etc.) to these terminals: supply to the COM terminal, and the device to the NO or NC terminal as required. The switched device should be a non-inductive load of not more than 10 amps; for reactive loads the current must be derated or protection circuits used. When the red LED is ON and the relay is in the energized state, the NO terminal will be closed and the NC terminal will be open.
5. **Time delay:** Use potentiometer to set delay from 0.15 to 60 seconds. Delay occurs during switch make and switch break.
6. **Input indicators:** Use these LEDs for indicating WET or DRY status of switch. When switch is WET, LED will be Amber. When switch is DRY, LED will either be Green for powered switches or OFF for reed switches.
Note: Powered switches may be reversed for WET/OFF, DRY/Amber indication.
7. **Invert switch:** This switch reverses the logic of the relay control in response to the switch(es): conditions that used to energize the relay will now de-energize the relay and vice versa.
8. **Latch switch (LVCN-120 and LVCN-130 series only):** This switch determines how the relay will be energized in response to the two sensor inputs. When LATCH is OFF, the relay responds to sensor Input A only; when LATCH is ON, the relay will energize or de-energize only when both switches (A and B) are in the same condition (both wet or both dry). The relay will remain latched until both switches change conditions.
9. **Input terminals:** Connect the switch wires to these terminals: **Note the polarity:** (+) is a 13.5 VDC, 27 mA power supply (connected to the red wire of a OMEGA ENGINEERING level switch), and (-) is the return path from the sensor (connected to the black wire of a OMEGA ENGINEERING level switch). If polarity is reversed, the sensors will not work.

Connecting switches to input terminals: Please note a difference between OMEGA ENGINEERING powered level switches and reed switches. All powered level switches (series LTU-100, LVU-150, LVP-51, LVC-152 & LVF-210 series) will be wired with the Red wire to the (+) terminal and the Black wire to the (-) terminal. OMEGA ENGINEERING reed switches (series LVV-110 & LVH-200 series) will have a particular wiring based upon part number. See the illustration below to indicate wiring for your switch. Note: the Shield wire will be used only for long cable runs or where excessive electrical noise is present.

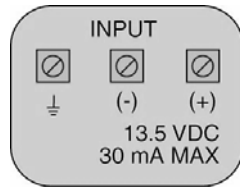
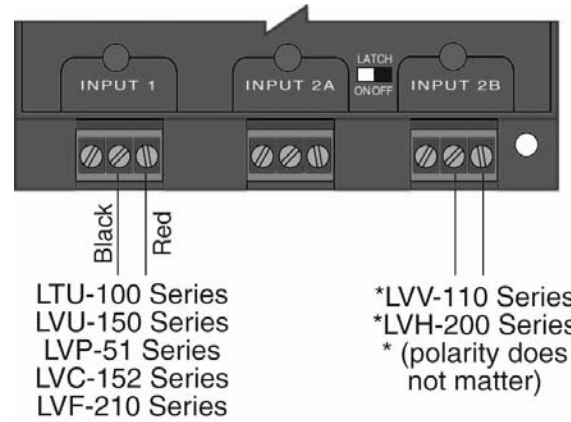

* LVV-110 series can be wired using the White and Black wires for NO operations or the Red and Black wires for NC operations.

LED Indication: Use LED's located above the input terminals to indicate whether the switch is in a wet or dry state. With powered switches, Green indicates dry and Amber indicates wet. With reed switches, Amber indicates wet and no LED indicates dry. Note: reed switches may be wired in reverse so that wet indicates dry and Amber indicates dry.

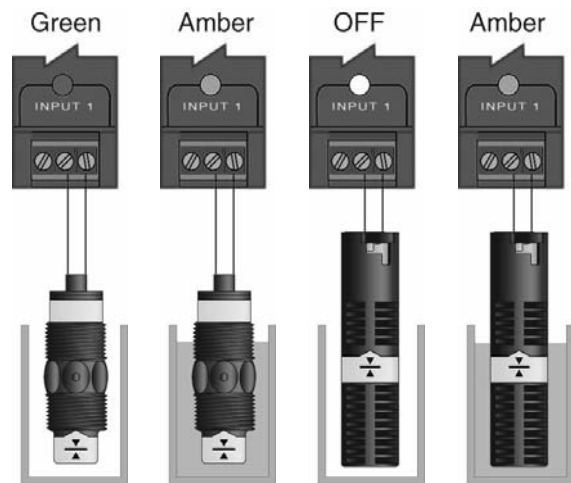

Powered Switches

Reed Switches

VAC Power Input Wiring: Observe the POWER SUPPLY label on the LVCN-120/-130/-140 series. The label identifies the power requirement (120 or 240 VAC) and the terminal wiring. **Note:** Polarity does not matter with the AC input terminal.

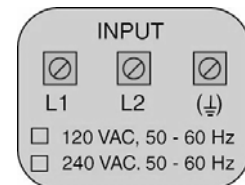
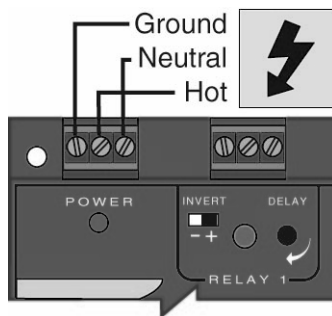
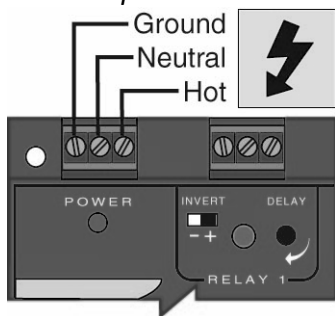

Relay Input Wiring: The relay is a single pole, double throw type rated at 250 Volts AC, 10 Amps, 1/4 Hp. The two terminal NO and NC (normally open and normally closed) will be used in different applications. Remember that the "normal" state is when the relay coil is de-energized and the Red relay LED is Off / de-energized.

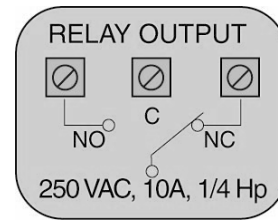

Changing from 120 to 240 VAC:

1. Remove the back panel of the controller and gently slide the printed circuit board from the housing. Use caution when removing the PCB.
2. Located jumpers JW1, JW2 and JW3 on the PCB.
3. To change to 240 VAC, remove jumpers from JW1 and JW2 and place a single jumper across JW3. To change to 120 VAC, remove jumper JW3 and place jumpers across JW1 and JW2.
4. Gently return PCB into housing and replace back panel.

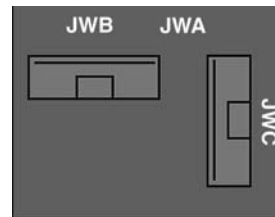

**120 VAC
Configuration**

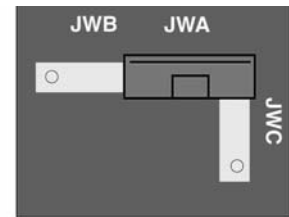

**240 VAC
Configuration**

Panel DIN Rail Mounting: The controller may be mounted by either a back panel using two screws through mounting holes located at the corners of the controller or by snapping the controller on 35 mm DIN Rail.

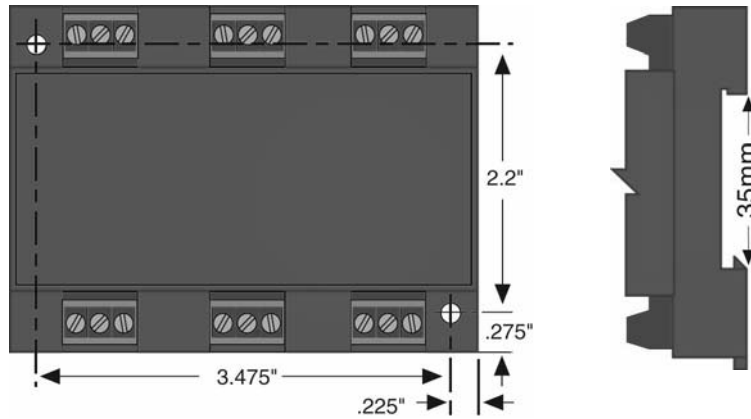

Note: Always install the controller in a location where it does not come into contact with liquid.

Low Level Alarm: The goal is to make sure that the liquid level does not fall below a certain point. If it does, an alarm is supposed to sound, alerting the operator of a low level condition.

If power is accidentally cut to the controller, the sensor's ability to notify the operator of a low level condition could be lost. The system must alert the operator not only to low liquid level, but to controller power loss.

To do this, connect the hot lead of the alarm to the NC side of the relay terminal of the controller. If power is lost, the relay will be de-energized, and the alarm will sound (if there is still power to the alarm circuit itself). The alarm circuit should have a non-interruptible power supply or some other indicator or backup alarm to warn of a power failure in the alarm circuit.

In this application, the normal status if the sensor at the bottom of the tank will be wet, and the relay will be energized holding the alarm circuit open. Both the relay LED and the Input LED will be on simultaneously, so for this application, Invert should be set to the OFF position.

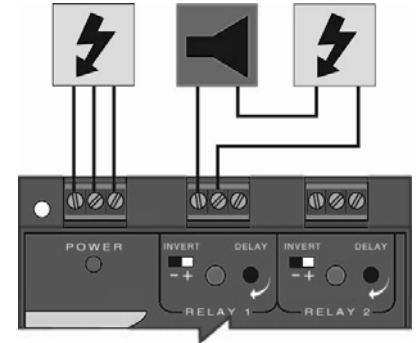

High Level Alarm: In the same manor, this system can be used to sound an alarm when fluid reaches a high level, with just a change in the location of the sensor and the setting of the Invert switch.

The alarm is still connected to the NC side of the relay to allow for a power failure alarm.

The sensor is normally dry. In this condition, we want the relay to be energized so the alarm does not sound: i.e., the Red relay LED should be on whenever the Input LED is Amber. So we turn Invert On. If the fluid level rises to the high sensor point, the sensor goes on, the relay de-energizes, and the alarm sounds.

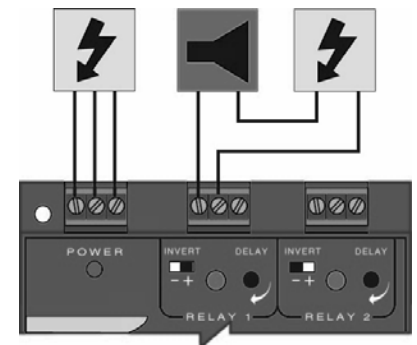

LED Indication: To determine whether the switch is in a wet or dry state, observe the LED's located above the input terminals. With powered switches, Green indicates dry and Amber indicates wet. With reed switches, Amber indicates wet and no LED indicates dry. **Note:** reed switches may be wired in reverse so that wet indicates dry and Amber indicates dry.

Automatic Fill: This system consists of a tank with a high level sensor, a low level sensor, and a pump that is controlled by the controller. Part of a proper fail-safe design for this particular system is that if power is lost to the controller for any reason, the pump filling the tank must be turned off. Therefore, we connect the pump to the NO side of the relay. When the relay is energized, the pump will turn on and fill the tank. The relay indicator will correspond directly to the ON/OFF status of the pump.

NOTE: If the pump motor load exceeds the rating of the controller's relay, a stepper relay of higher capacity must be used as part of the system design.

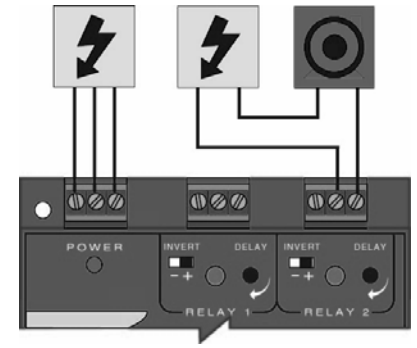

Determining the settings of LATCH and INVERT: This is the way the system must operate:

- When both the high and low sensors are dry, the pump should turn on, starting to fill the tank.
- When the low sensor gets wet, the pump should stay on.
- When the high sensor gets wet, the pump should turn off.

Latch: In any two-sensor control system, LATCH must be ON.

Invert: Referring to the logic chart in Step Nine, we look for the setting that will de-energize the relay (start the pump) when both inputs are wet (Amber LEDs). In this system, Invert should be ON.

Determining A or B input connections: When LATCH is ON, there is no effective difference between Input A and B, since both sensors must have the same signal in order for status to change. When wiring any two-input relay section, the only consideration for hooking a particular sensor to A or B is if LATCH will be OFF.

Automatic Empty: Note that similar system logic can be used for an automatic empty operation simply by controlling a pump that pumps fluid out of the tank instead of into it. However, note the importance of fail-safe design. If the tank is being passively filled, and a pump must be used to actively empty it, a power failure to either the controller or the pump circuits will cause overflow.

Alternatively, an electrically-controlled drain valve could be used. In this case, the valve should be a type that will automatically open if power is lost; in other words, power must be used to hold it closed. The valve would be connected to the NO side of the relay—if power is lost to the controller, the relay de-energizes, the valve loses the power that was holding it shut, and fluid will drain from the tank into some other safe containment until power is restored. In this system, whenever the red relay LED of the controller is ON, the drain is closed, allowing fluid to rise.

In this case, Invert should be ON: when both sensors are wet, the relay de-energizes, the switch to the valve opens, and the tank will drain.

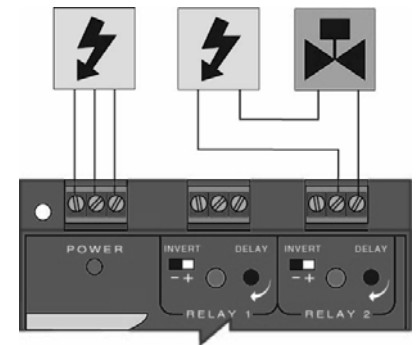

Controller Logic: Please use the following guide to understand the operation of the controllers.

1. **Power LED:** Make sure the Green power LED is ON when power is supplied to the controller.
2. **Input LED(s):** The input LED(s) on the controller will be Amber when the switch(es) is/are wet and Green or OFF when the switch(es) is/are dry. If the LED's are not switching the input LED, test the level switch.
3. **Single-Input Relays:** When the input LED turn OFF and ON, the relay LED will also switch. With invert OFF, the relay LED will be ON when the input LED is ON and OFF when the input LED is OFF. With invert ON, the relay LED will be OFF when the input LED is ON and ON when the input LED is OFF.
4. **Dual-Input (latching) Relays:** When both inputs are wet (Amber LED's ON), the relay will be energized (Red LED ON). After that, if one switch becomes dry, the relay will remain energized. Only when both switches are dry (both amber LED's OFF) will the controller de-energize the relay. The relay will not energize again until both switches are wet. See the Relay Latch Logic Chart below for further explanation.

Relay Latch Logic Table (latching relays only): The relay can either be an independent relay (high or low level alarm) or can be a latching relay (automatic fill or empty) with latch ON. With Latch OFF, the relay will only respond to the INPUT A setting. INPUT B will be ignored.

With Latch ON, the relay will actuate when INPUT A and INPUT B are in the same condition. The relay will not change its condition until both inputs reverse their state.

Invert OFF		Latch OFF
INPUT A*	INPUT B*	Relay
ON	No Effect	ON
OFF	No Effect	OFF

Invert ON		Latch Off
INPUT A*	INPUT B*	Relay
ON	No Effect	OFF
OFF	No Effect	ON

Caution: Some sensors (particularly buoyancy sensors) may have their own inverting capability (wired NO or NC). This will change the logic of the invert switch. Check your system design.

Invert OFF		Latch ON
INPUT A*	INPUT B*	Relay
ON	ON	ON
OFF	ON	No Change
ON	OFF	No Change
OFF	OFF	OFF

Invert ON		Latch ON
INPUT A*	INPUT B*	Relay
ON	ON	OFF
OFF	ON	No Change
ON	OFF	No Change
OFF	OFF	ON

Troubleshooting

PROBLEM	SOLUTION
Relay switches only from input A (ignores input B)	Latch is turned OFF. Flip the latch switch to turn ON.
Level reaches alarm ON, but relay is OFF.	First, check to make sure the input LED is ON. If not, check wiring to sensor. Second, check status of Relay LED. If incorrect, flip the Invert switch to change the relay state.
Pump or Valve is supposed to stop, but it does not.	First, check to make sure the input LEDs are both in the same state (both ON or both OFF). If not, check wiring to sensor each sensor. Second, check status of Relay LED. If incorrect, flip the Invert switch to change the relay state.
Controller is powered, but nothing happens.	First check the Power LED to make sure it is Green. If not, check the wiring, power and make sure the terminal is seated correctly over the 6-pins.



WARRANTY/DISCLAIMER

OMEGA ENGINEERING, INC. warrants this unit to be free of defects in materials and workmanship for a period of **13 months** from date of purchase. OMEGA's WARRANTY adds an additional one (1) month grace period to the normal **one (1) year product warranty** to cover handling and shipping time. This ensures that OMEGA's customers receive maximum coverage on each product.

If the unit malfunctions, it must be returned to the factory for evaluation. OMEGA's Customer Service Department will issue an Authorized Return (AR) number immediately upon phone or written request. Upon examination by OMEGA, if the unit is found to be defective, it will be repaired or replaced at no charge. OMEGA's WARRANTY does not apply to defects resulting from any action of the purchaser, including but not limited to mishandling, improper interfacing, operation outside of design limits, improper repair, or unauthorized modification. This WARRANTY is VOID if the unit shows evidence of having been tampered with or shows evidence of having been damaged as a result of excessive corrosion; or current, heat, moisture or vibration; improper specification; misapplication; misuse or other operating conditions outside of OMEGA's control. Components in which wear is not warranted, include but are not limited to contact points, fuses, and triacs.

OMEGA is pleased to offer suggestions on the use of its various products. However, OMEGA neither assumes responsibility for any omissions or errors nor assumes liability for any damages that result from the use of its products in accordance with information provided by OMEGA, either verbal or written. OMEGA warrants only that the parts manufactured by the company will be as specified and free of defects. OMEGA MAKES NO OTHER WARRANTIES OR REPRESENTATIONS OF ANY KIND WHATSOEVER, EXPRESSED OR IMPLIED, EXCEPT THAT OF TITLE, AND ALL IMPLIED WARRANTIES INCLUDING ANY WARRANTY OF MERCHANTABILITY AND FITNESS FOR A PARTICULAR PURPOSE ARE HEREBY DISCLAIMED. LIMITATION OF LIABILITY: The remedies of purchaser set forth herein are exclusive, and the total liability of OMEGA with respect to this order, whether based on contract, warranty, negligence, indemnification, strict liability or otherwise, shall not exceed the purchase price of the component upon which liability is based. In no event shall OMEGA be liable for consequential, incidental or special damages.

CONDITIONS: Equipment sold by OMEGA is not intended to be used, nor shall it be used: (1) as a "Basic Component" under 10 CFR 21 (NRC), used in or with any nuclear installation or activity; or (2) in medical applications or used on humans. Should any Product(s) be used in or with any nuclear installation or activity, medical application, used on humans, or misused in any way, OMEGA assumes no responsibility as set forth in our basic WARRANTY/DISCLAIMER language, and, additionally, purchaser will indemnify OMEGA and hold OMEGA harmless from any liability or damage whatsoever arising out of the use of the Product(s) in such a manner.

RETURN REQUESTS/INQUIRIES

Direct all warranty and repair requests/inquiries to the OMEGA Customer Service Department. BEFORE RETURNING ANY PRODUCT(S) TO OMEGA, PURCHASER MUST OBTAIN AN AUTHORIZED RETURN (AR) NUMBER FROM OMEGA'S CUSTOMER SERVICE DEPARTMENT (IN ORDER TO AVOID PROCESSING DELAYS). The assigned AR number should then be marked on the outside of the return package and on any correspondence.

The purchaser is responsible for shipping charges, freight, insurance and proper packaging to prevent breakage in transit.

FOR **WARRANTY** RETURNS, please have the following information available BEFORE contacting OMEGA:

1. Purchase Order number under which the product was PURCHASED,
2. Model and serial number of the product under warranty, and
3. Repair instructions and/or specific problems relative to the product.

FOR **NON-WARRANTY** REPAIRS, consult OMEGA for current repair charges. Have the following information available BEFORE contacting OMEGA:

1. Purchase Order number to cover the COST of the repair,
2. Model and serial number of the product, and
3. Repair instructions and/or specific problems relative to the product.

OMEGA's policy is to make running changes, not model changes, whenever an improvement is possible. This affords our customers the latest in technology and engineering.

OMEGA is a registered trademark of OMEGA ENGINEERING, INC.

© Copyright 2009 OMEGA ENGINEERING, INC. All rights reserved. This document may not be copied, photocopied, reproduced, translated, or reduced to any electronic medium or machine-readable form, in whole or in part, without the prior written consent of OMEGA ENGINEERING, INC.

Where Do I Find Everything I Need for Process Measurement and Control? **OMEGA...Of Course!** *Shop online at omega.comSM*

TEMPERATURE

- M Thermocouple, RTD & Thermistor Probes, Connectors, Panels & Assemblies
- M Wire: Thermocouple, RTD & Thermistor
- M Calibrators & Ice Point References
- M Recorders, Controllers & Process Monitors
- M Infrared Pyrometers

PRESSURE, STRAIN AND FORCE

- M Transducers & Strain Gages
- M Load Cells & Pressure Gages
- M Displacement Transducers
- M Instrumentation & Accessories

FLOW/LEVEL

- M Rotameters, Gas Mass Flowmeters & Flow Computers
- M Air Velocity Indicators
- M Turbine/Paddlewheel Systems
- M Totalizers & Batch Controllers

pH/CONDUCTIVITY

- M pH Electrodes, Testers & Accessories
- M Benchtop/Laboratory Meters
- M Controllers, Calibrators, Simulators & Pumps
- M Industrial pH & Conductivity Equipment

DATA ACQUISITION

- M Data Acquisition & Engineering Software
- M Communications-Based Acquisition Systems
- M Plug-in Cards for Apple, IBM & Compatibles
- M Datalogging Systems
- M Recorders, Printers & Plotters

HEATERS

- M Heating Cable
- M Cartridge & Strip Heaters
- M Immersion & Band Heaters
- M Flexible Heaters
- M Laboratory Heaters

ENVIRONMENTAL MONITORING AND CONTROL

- M Metering & Control Instrumentation
- M Refractometers
- M Pumps & Tubing
- M Air, Soil & Water Monitors
- M Industrial Water & Wastewater Treatment
- M pH, Conductivity & Dissolved Oxygen Instruments