

# User's Guide

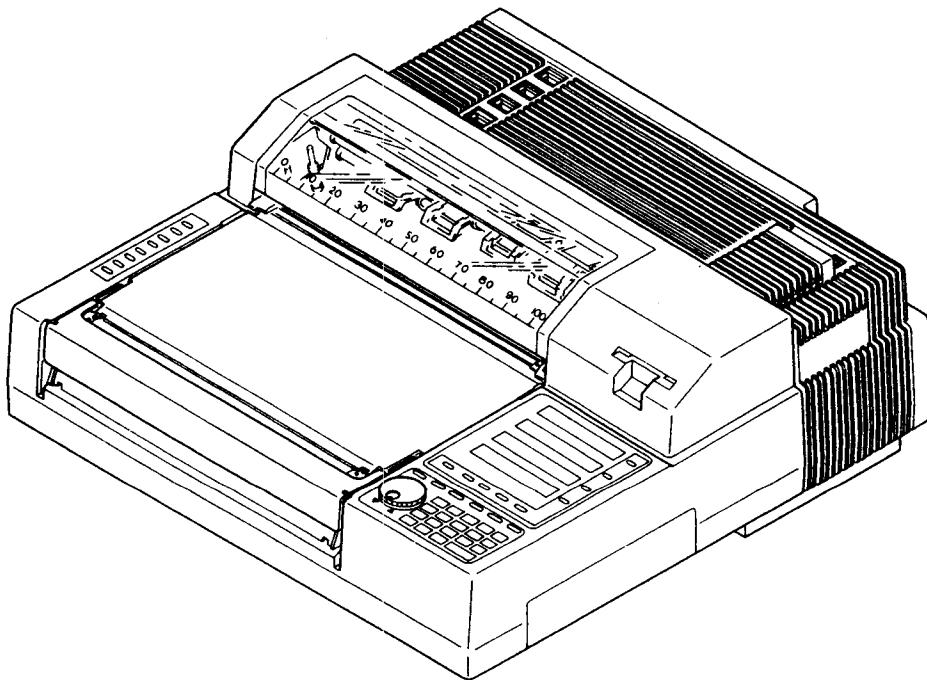

<http://www.omega.com>  
e-mail: [info@omega.com](mailto:info@omega.com)

**RD3721**  
**Flatbed Recorder with Printer**  
**RD3722**  
**Flatbed Recorder without Printer**



**OMEGAnet<sup>SM</sup> On-Line Service**  
<http://www.omega.com>

**Internet e-mail**  
[info@omega.com](mailto:info@omega.com)

### **Servicing North America:**

**USA:**  
ISO 9001 Certified

One Omega Drive, Box 4047  
Stamford, CT 06907-0047  
Tel: (203) 359-1660  
e-mail: [info@omega.com](mailto:info@omega.com)

FAX: (203) 359-7700

**Canada:**

976 Bergar  
Laval (Quebec) H7L 5A1  
Tel: (514) 856-6928  
e-mail: [canada@omega.com](mailto:canada@omega.com)

FAX: (514) 856-6886

### **For immediate technical or application assistance:**

**USA and Canada:** Sales Service: 1-800-826-6342 / 1-800-TC-OMEGA<sup>SM</sup>  
Customer Service: 1-800-622-2378 / 1-800-622-BEST<sup>SM</sup>  
Engineering Service: 1-800-872-9436 / 1-800-USA-WHEN<sup>SM</sup>  
TELEX: 996404 EASYLINK: 62968934 CABLE: OMEGA

**Mexico and  
Latin America:**

Tel: (95) 800-TC-OMEGA<sup>SM</sup>  
En Español: (203) 359-7803

FAX: (95) 203-359-7807  
e-mail: [espanol@omega.com](mailto:espanol@omega.com)

### **Servicing Europe:**

**Benelux:**

Postbus 8034, 1180 LA Amstelveen, The Netherlands  
Tel: (31) 20 6418405  
Toll Free in Benelux: 06 0993344  
e-mail: [nl@omega.com](mailto:nl@omega.com)

FAX: (31) 20 6434643

**Czech Republic:**

ul. Rude armady 1868, 733 01 Karvina-Hranice, Czech Republic  
Tel: 420 (69) 6311627  
e-mail: [czech@omega.com](mailto:czech@omega.com)

FAX: 420 (69) 6311114

**France:**

9, rue Denis Papin, 78190 Trappes  
Tel: (33) 130-621-400  
Toll Free in France: 0800-4-06342  
e-mail: [france@omega.com](mailto:france@omega.com)

FAX: (33) 130-699-120

**Germany/Austria:**

Daimlerstrasse 26, D-75392 Deckenpfronn, Germany  
Tel: 49 (07056) 3017  
Toll Free in Germany: 0130 11 21 66  
e-mail: [germany@omega.com](mailto:germany@omega.com)

FAX: 49 (07056) 8540

**United Kingdom:**  
ISO 9002 Certified

25 Swannington Road,  
Broughton Astley, Leicestershire,  
LE9 6TU, England  
Tel: 44 (1455) 285520  
FAX: 44 (1455) 283912

P.O. Box 7, Omega Drive,  
Irlam, Manchester,  
M44 5EX, England  
Tel: 44 (161) 777-6611  
FAX: 44 (161) 777-6622

Toll Free in England: 0800-488-488

e-mail: [uk@omega.com](mailto:uk@omega.com)

It is the policy of OMEGA to comply with all worldwide safety and EMC/EMI regulations that apply. OMEGA is constantly pursuing certification of its products to the European New Approach Directives. OMEGA will add the CE mark to every appropriate device upon certification.

The information contained in this document is believed to be correct but OMEGA Engineering, Inc. accepts no liability for any errors it contains, and reserves the right to alter specifications without notice.

**WARNING:** These products are not designed for use in, and should not be used for, patient connected applications.

# How to use this Instruction Manual

This instruction manual describes the standard functions and operating procedures of RD3721 and RD3722 recorders. Options are discussed either in the rear of this manual or in a separate manual (for the list of options, refer to the following):

<u>OPTION NAME</u>	<u>SUFFIX*</u>	<u>MANUAL NUMBER</u>
Calculation function	-MATH	rear of this manual (M1348)
Built-in alarm	-AK04	rear of this manual (M1348)
Remote control	-REM	rear of this manual (M1348)
GPIB Interface	/GP-IB or -GPIB	M1432
RS232C Interface	/RS232C or -RS232	M1432

\*Note: The suffix with a "-" or "/" means the same thing.

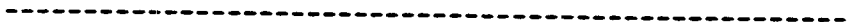

## UNPACKING

Remove the Packing List and verify that all equipment has been received. If there are any questions about the shipment, please call the OMEGA Customer Service Department.

Upon receipt of shipment, inspect the container and equipment for any signs of damage. Take particular note of any evidence of rough handling in transit. Immediately report any damage to the shipping agent.

### NOTE

The carrier will not honor any claims unless all shipping material is saved for their examination. After examining and removing contents, save packing material and carton in the event reshipment is necessary.

**This Page is Intentionally Blank.**

# CONTENTS

<b>How to use this Instruction Manual</b> .....	1
<b>1. UPON RECEIVING THE PRODUCT</b> .....	
1.1 Checking the Model and Its Specifications .....	1-1
1.2 Checking the Accessories and Appearance .....	1-4
1.3 Prior to Using the Recorder .....	1-6
<b>2. OUTLINE</b> .....	
2.1 Product Outline .....	2-1
2.2 Features .....	2-1
2.3 Recording Examples .....	2-3
2.3.1 Four Analog Recording Channels Plus Various Print-outs (RD3721 only) .....	2-3
2.3.2 List Print-out (RD3721 only) .....	2-5
2.3.3 List Print-out Description (RD3721 only) .....	2-6
<b>3. FUNCTIONAL DESCRIPTION</b> .....	
3.1 Front Panel .....	3-1
3.2 Rear Panel .....	3-5
3.3 Side Panel (Left Side) .....	3-5
<b>4. INSTALLATION</b> .....	
4.1 Installation Location .....	4-1
4.2 External Dimensions .....	4-1
<b>5. WIRING</b> .....	
5.1 Power Supply .....	5-1
5.2 Input .....	5-1
5.2.1 DC voltage and Thermocouple .....	5-1
5.2.2 RTD Input .....	5-3
<b>6. OPERATION</b> .....	
6.1 Operating Procedure Flow Chart .....	6-1
6.2 Preparation .....	6-3
6.2.1 Ribbon Cassette Installation and Replacement .....	6-3
6.2.2 Chart Loading and Replacement .....	6-6
6.2.3 Chart Recoll Unit (/REROL) Attachment (Option) .....	6-11
6.2.4 Pen Cartridge Mounting and Replacement .....	6-14
6.2.5 Battery Replacement .....	6-16
6.2.6 Battery Installation and Replacement (from the IC memory card) ..	6-17
6.3 Turning the Power Supply ON .....	6-18
6.4 Setting .....	6-20
6.4.1 Setting the Chart Feed Speed .....	6-20
6.4.2 Measuring Range Setting .....	6-22
6.4.3 ZERO Adjustment .....	6-48
6.4.4 SPAN Adjustment .....	6-49

6.4.5	RECORDING AREA ADJUST (Zone recording)	6-51
6.4.6	Alarm Setting	6-52
6.4.7	TAG No. Setting (RD3721 only)	6-55
6.4.8	Partially Suppressed and Expanded Recording Setting	6-56
6.4.9	AUTO.Span Shift Mode Setting	6-59
6.4.10	Message Setting (RD3721 only)	6-61
6.4.11	Time Setting	6-63
6.4.12	Set - value Initialization (RAM CLEAR)	6-65
6.4.13	IC Memory Card Setting	6-66
	1. 8KB IC Memory Card (RD-MC8)	6-66
	<Setting Information Memory>	6-67
	2. 256KB IC Memory Card (RD-MC256)	6-70
	<Setting Information Memory>	6-70
	<Measured Data Memory>	6-71
	Writing Data (WRITE)	6-74
	Reading Data (READ)	6-83
	WRITE Information (INFO)	6-87
6.4.14	SET UP Mode	6-89
6.4.15	Program Table	6-104
6.4.16	Error Message	6-105
<b>7.</b>	<b>MAINTENANCE</b>	<b>7-1</b>
	7.1 Fuse Replacement	7-1
	7.2 Cleaning	7-3
<b>8.</b>	<b>SPECIFICATIONS</b>	<b>8-1</b>
<b>9.</b>	<b>ADJUSTMENT</b>	<b>9-1</b>
	9.1 Span Adjustment	9-1
	9.2 A/D Accuracy Adjustment	9-3
<b>10.</b>	<b>OVERALL WIRING</b>	<b>10-1</b>

# 1. UPON RECEIVING THE PRODUCT

The OMEGA® RD3721/RD3722 Recorder has been delivered after a thorough in-house inspection. However, make sure of the following when you receive it.

## 1.1 Checking the Model and Its Specifications

The RD3721/RD3722 Recorder is provided with a nameplate on its rear panel that indicates the model number, etc as shown in Figure 1.1. When you receive your recorder, check the information on the nameplate to make sure that it is specified by your order. Also, when you contact OMEGA, inform the caller of the Model number and serial number as given on the nameplate.

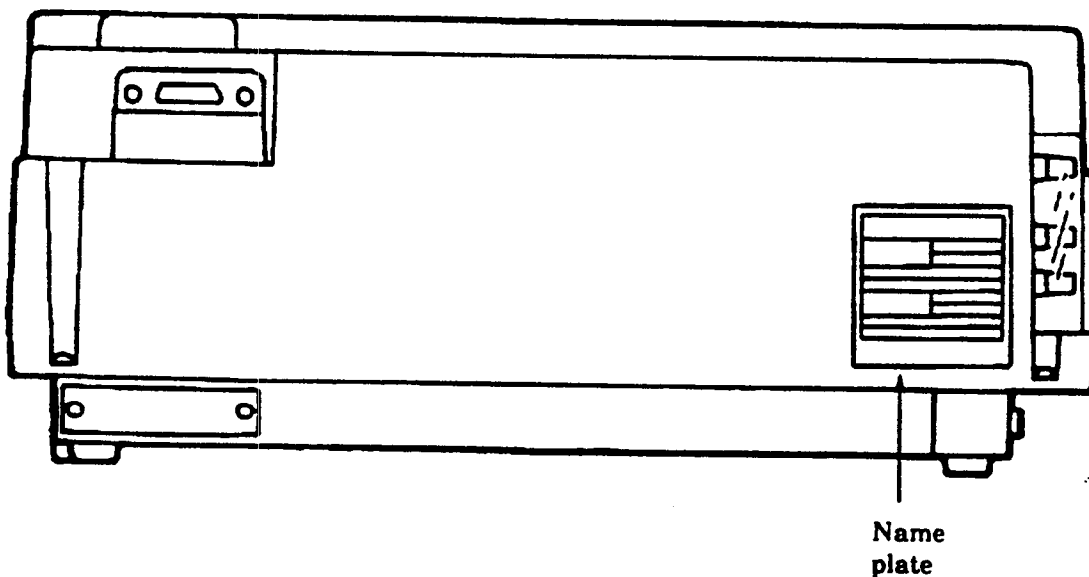

Figure 1.1

## Model and Suffix Code

MODELS AND OPTIONS

<u>PART NUMBER</u>	<u>DESCRIPTION</u>
RD3721-12	1 pen recorder, T/C, V with printer and electrical pen lift
RD3721-15	1 pen recorder, T/C, RTD, V with printer and electrical pen lift
RD3721-22	2 pen recorder, T/C, V with printer and electrical pen lift
RD3721-25	2 pen recorder, T/C, RTD, V with printer and electrical pen lift
RD3721-32	3 pen recorder, T/C, V with printer and electrical pen lift
RD3721-35	3 pen recorder, T/C, RTD, V with printer and electrical pen lift
RD3721-42	4 pen recorder, T/C, V with printer and electrical pen lift
RD3721-45	4 pen recorder, T/C, RTD, V with printer and electrical pen lift
RD3722-12	1 pen recorder, T/C, V without printer, with manual pen lift
RD3722-15	1 pen recorder, T/C, RTD, V without printer, with manual pen lift
RD3722-22	2 pen recorder, T/C, V without printer, with manual pen lift
RD3722-25	2 pen recorder, T/C, RTD, V without printer, with manual pen lift
RD3722-32	3 pen recorder, T/C, V without printer, with manual pen lift
RD3722-35	3 pen recorder, T/C, RTD, V without printer, with manual pen lift
RD3722-42	4 pen recorder, T/C, V without printer, with manual pen lift
RD3722-45	4 pen recorder, T/C, RTD, V without printer, with manual pen lift

OPTIONS

<u>OPTION CODE</u>	<u>DESCRIPTION</u>
-AKO4	Alarms (internal, 4 points)
-MATH	Mathematical functions
-GPIB	GPIB interface
-RS232	RS232C interface
-REM	Remote Controls (consult sales)
-DF	°F display (consult sales)
-ROL	Roll chart drive function (consult sales)
-REROL	Reroll function (consult sales)



## Accessories & Spares

Name		Standard accessories	Model	
			Part No	Order Q'ty
Ribon cassette		1 pc.	RD3720-RC	1 unit (1 pc. / unit)
Z - fold chart (344mm x 20m)		1 chart	RD3720-ZFP	10 units (1 pc. / unit)
Roll chart (344mm x 20m)		1 chart	RD3720-RP	10 units (1 pc. / unit)
* Disposal felt - tip pen cartridge	1st channel(red)	—	RD3720-01	1 unit (3 pcs. / unit)
	2nd channel(green)	—	RD3720-02	
	3rd channel(blue)	—	RD3720-03	
	4th channel(brown)	—	RD3720-04	
IC memory card (setting data)		1 pc.8KB	RD-MC8	1 unit (1 pc. / unit)
Dust cover		—	B9619AV	
Lithium battery (for mainframe)		1 pc.	B9588ZB	
Lithium battery (for RD-MC8 )		1 pc.	B9586JU	2 units (1 pc. / unit)
Lithium battery (for RD-MC256)		—	B9586JV	
Measurement leads (1m)		—	B9409JA	1 set
Power cord		1 set		
Fuse		1 pc.		

### ACCESSORY

Part Name	Part No.	Description
IC memory card	RD-MC256	256 KB

## 1.2 Checking the Accessories and Appearance

The recorder is provided with the accessories shown in Figure 1.2.

Check the accessories to make sure that they are all there. Further, visually check the recorder to make sure that it has not been damaged.

Should the number of accessories be short or the recorder be damaged, contact the representative where you purchased it.

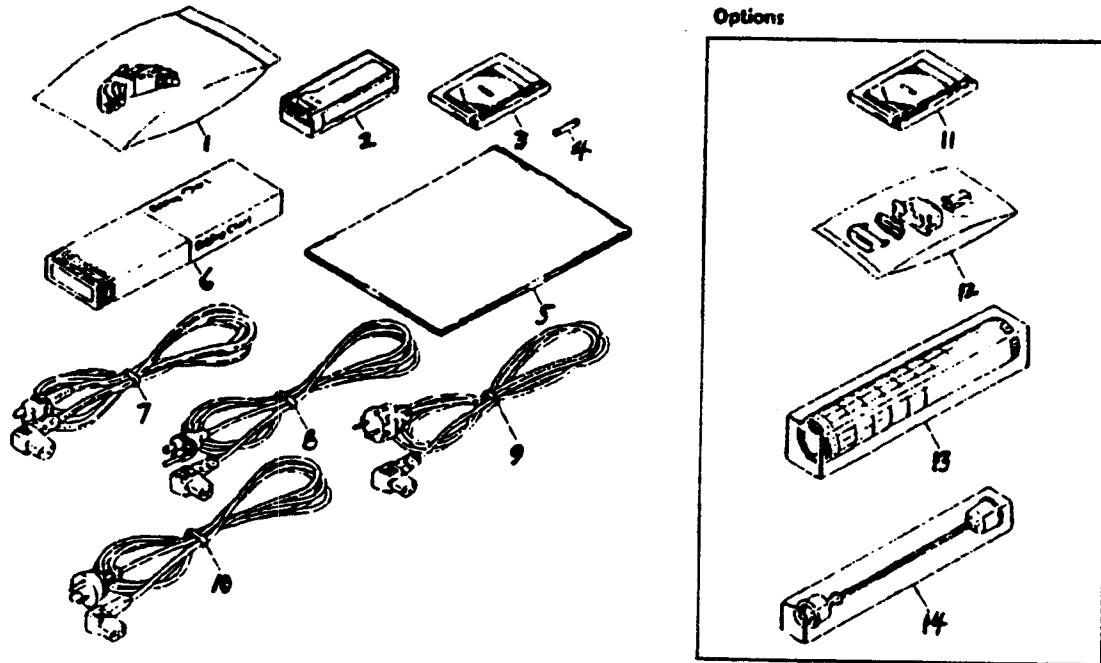

Figure 1.2

Table 1.1

Standard Accessory	No.	Name	Part No.	Qty	Remarks
	1	Pen cartridge	-	1/color	same as No. of pens
	2	Ribbon cassette	RD3720-RC	1	RD3721
	3	IC memory card	RD-MC8	1	8K byte
	4	Fuse	A9134 KF	1	(Installed in fuse holder)
	5	Operator's Manual	M1348	1	
	*6	Chart, folding	RD3720-ZFP	1	About 20m
	7	Cable assembly	(other than UL, VDE, and SAA)		- special order
	8	Cable assembly	(for UL)		
	9	Cable assembly	(for VDE - special order)		
	10	Cable assembly	(for SAA - special order)		
Option	11	IC memory card	RD-MC256	1	256K byte
	12	Connector (for alarm, remote control)	A9026KC	1	
	13	Roll chart paper	RD3720-RP	1	about 20 m
	14	Stock roller		1	when /ROL or /REROL is specified

\* When /ROL or /REROL is specified, roll chart paper is delivered instead of the folding chart paper

## <Optional Reroll Function (/REROL)>

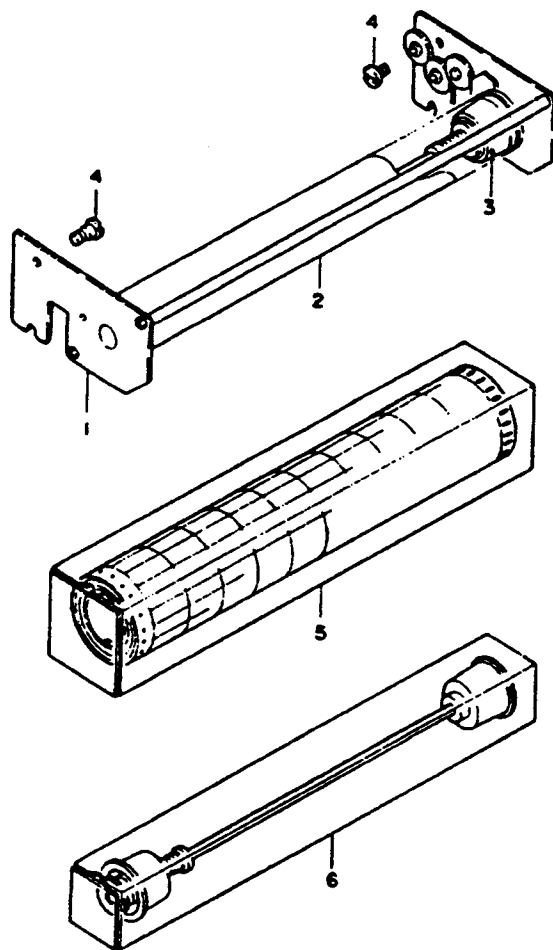

Figure 1.3

Table 1.2

Standard Accessory	No.	Name	Part No.	Qty	Remarks
	①	Reroll metal fitting	-	1/color	same as No. of pens
	②	Roll core	.B9585SH	1	RD3721 only
	③	Reroll stock roller	3789 01	1	8KB
	④	mounting screw	A9134KF	1	(Installed in fuse holder)
	*⑤	Roll chart paper	RD3720-RP	1	about 20m
	⑥	Chart stock roller		1	

\*The reroll chart cassette (with gear) are delivered together with the recorder by specifying /REROL when ordering.

## 1.3 Prior to Using the Recorder

After unpacking the recorder, open the top transparent cover to remove Shipment packing as shown in Figure 1.4

- (1) Peel the top transparent cover seal to expose the cover.
  - (2) remove the cushions located on both left and right sides of the pen carriage.
  - (3) Remove the tie wire (RD3721 only) holding the printer head in the center.
  - (4) Unpacking procedures are completed.
- The recorder is now ready to use.

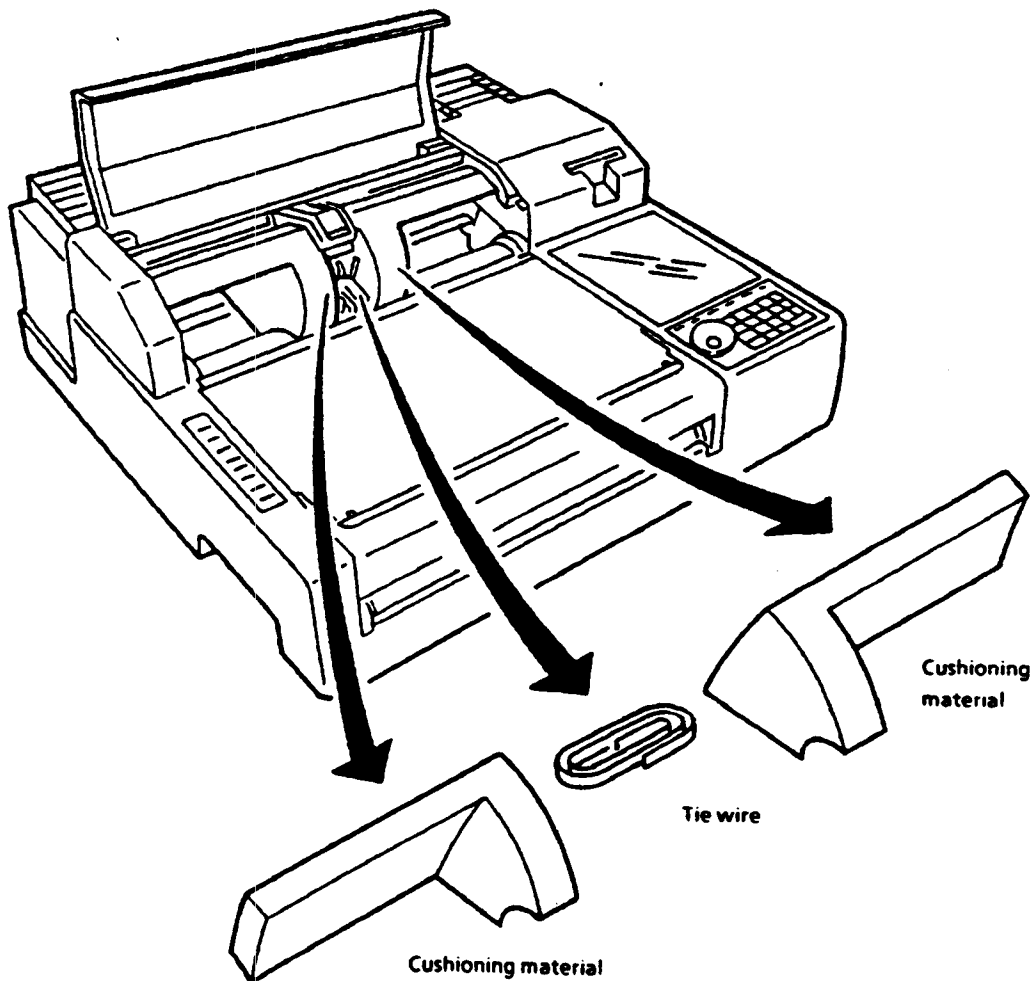

Figure 1.4

## 2. OUTLINE

### 2.1 Product Outline

OMEGA's RD3721/RD3722 is a high performance, multipen recorder. Any DC voltage, thermocouple or RTD input can be selected for each channel. In addition to analog recording, the recorder also allows measured values, dates, scales, alarm lists, and messages to be printed out or partial suppression-recorded through the use of a wire dot printer. Easy-to-read fluorescent display tubes are used and the recorder is capable of selecting measured data, bar-graph and range data displays for each channel. Thus, while the RD3721/RD3722 offers high performance, it is easy to operate. Basic items such as range and chart speed can be easily set interactively with the display unit via function keys and setting knobs.

Further, the recorder range of applications can be expanded by adding various optional functions, such as the memory function in the form of an IC memory card, calculation and GPIB/RS232 communications functions, and an alarm output.

### 2.2 Features

#### ■ Highly Functional and Intelligent

- Wide range of DC voltage, thermocouple and RTD inputs  
A single RD3721/RD3722 recorder can cope with all DCV, T/C, and RTD inputs. Further, it has cryogenic gold-iron-cromege™ (KP vs Au7Fe) T/C input which is built into it as standard equipment.

- Versatile print-out functions (RD3721 only).  
Includes measured data, date, scale markings, alarms, messages, manual prints, lists, etc.

- A choice of 3 display functions  
Measured data, bar-graph and range data can be selected as required.

- Zone recording (recording area adjustment)  
The recording range can be arbitrarily set by adjusting the pen position.

- Partial suppression and extension  
The RD3721/RD3722 can suppress the recording of unnecessary areas and extend the recording of important areas.

- AUTO span shift  
Selecting this mode automatically shifts the recording span by + 50%, and continues recording when an input exceeds the measuring range (span).

#### ■ Computer Friendly

- GP-IB and RS-232C interfaces bi-directional communication is available in which both interfaces allow data output and panel setting. Further, communication input can be analog-recorded, enabling raw measured data and communication input data to be recorded simultaneously.

- **Simple operation**  
The RD3721/RD3722 can be operated as simply as conventional analog recorders, even though it has multifunctional capabilities. Using the function keys and setting knobs, various settings are made simply by using an interactive system with the display unit.
- **New recording mechanism**  
The adoption of new pens allows the recorder to record for about 1500 m (about twice that of conventional units).  
Further, the chart is 20 m long, enabling continuous operating time to be extended considerably. In addition, the provision of grooves in the platen has almost eliminated ink blots at the chart folding lines, which is a problem at low chart feed speeds in conventional recorders.
- **High-speed Response 1600 mm/s**  
Maximum pen speed is 1600 mm/s, significantly improving traceability at high-speed.
- **IC memory Card**  
An IC memory card stores the set values and measured data.
  - **Set value memory (standard)**  
Previously-used set values can be stored in an IC memory card and used again simply by inserting the IC memory card into the unit.
  - **Set value and data memory (optional)**  
Can store measured data in which an alarm or external contact is triggered. Memory capacity is 256K bytes and the memory can store a maximum of 32,000 data/channel.  
Stored data can be recorded or output for communication as required.
- **Power Supply: 90 to 250V AC**
- **A wide range of Optional Features**
  - **Mathematical functions (/MATH)**  
This function is in addition to the standard difference calculation and scaling functions and is capable of executing various calculations such as arithmetic operations, square root extraction (SQR), absolute value (ABS), common logarithms (LOG) and exponents (EXP). Calculated data can be recorded or output for communication.
  - **Remote control function (/REM)**  
Chart start/stop, chart speed control, chart speed change, recording ON/OFF selection, message, and manual print-out are controlled remotely. Selecting recording ON/OFF allows the pens to be raised and lowered independently.
  - **Alarm output (/AK-04)**  
Four alarm outputs can be obtained and two upper or lower limit alarm levels can be set per channel.
  - **Roll chart drive function (/ROL)**  
The roll chart can be used by attaching hardware for roll chart.
  - **Reroll function (/REROLL)**  
The roll chart can be rerolled by using a chart cassette which is provided with reroll functions.

## 2.3 Recording Examples

### 2.3.1 Four Analog Recording Channels Plus Various Print-outs

(RD3721 only)

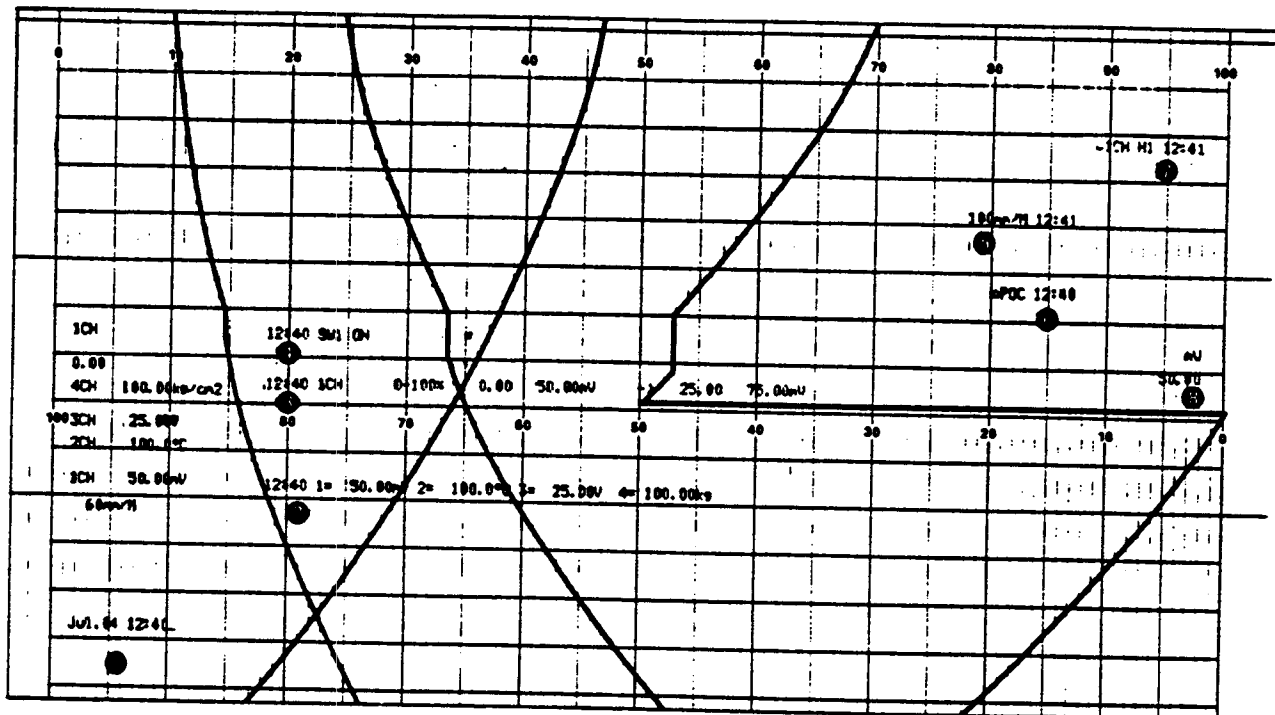

(1) **Fixed Time Print-out (\*)**

Executes print-out per specified time span (minimum : 1 minute).

(2) **Manual Print-out**

Pressing the MAN PRINT key prints out the time and measured data for all channels in a single line.

(3) **Range Change Print-out**

The range change and time contents are printed out when the range is changed in the AUTO Span Shift mode.

(4) **Message Print-out**

Can be set arbitrarily within 70 characters (with time data)

MESSAGE (0) : Pressing the MESSAGE key starts print-out.

MESSAGE (1 to 4) : If the REMOTE function (optional) is provided, print-out is executed at external contact input. (4 points maximum).

(5) **Print-out at Chart Speed Change**

Chart speed and the time prior to and following a chart speed change are printed out.

(6) **Pen-Offset Compensation ON / OFF Print-out**

The ON / OFF mark and time are printed out when pen-offset compensation is ON / OFF.

(7) **Alarm Print-out (\*)**

The channel No., alarm type, and ON / OFF time are printed out.

**(8) Scale Print Out (\*)**

0% and 100% values are printed out at the same intervals as fixed time print-out.

Note) In (1), (6) above and chart start print-out, when pen-offset compensation is set to AUTO, (selection at SET UP mode. If AUTO is not selected, channel is always pen-offset compensation reference channel) the pen-offset compensation reference channel is printed out.

example  $\Delta$ Poc 3                      12:40

This indicates that the reference channel is 3CH and Pen-offset Compensation is ON.

When the chart paper is fed for a fixed length, the print-out marked with (\*) executes the next line printing.

Hence if the chart feeding speed is slow, it takes much time to start print-out. The print-out marked with (\*) is disabled while chart feed is halted.

Any of the print-out other than that of the marked with (\*) executes print-out with the change recognized.

When the chart feed is halted, one line is fed after pointing (manual print message print-out). For other cases, print-out is disabled while chart feed is halted.

When starting the chart, each print-out is executed corresponding to the change at this time line feeding after print-out is disabled.

Hence, if the chart feed speed is slow print-out may overlap the previous print-out data. Further, when multiple print-out data occurs at the same time, print-out may be executed with a little lag time.

Further move, when the chart is fed in high speed the print-out may be slanted.

<Relationship between Fixed-time Printout and Chart Feeding Speed>

Chart Feeding Speed				Fixed Time Print-out Intervals
mm/min	inch/min	mm/h	inch/h	
1200~300	45.0~12.0	—	—	Every minute
299~30	11.9~1.2	—	—	Every 10 minute
29~10	1.1~0.5	1200~120	45.0~5.0	Every hour
—	—	119~60	4.9~2.4	Every 2 hours
—	—	59~40	2.3~1.6	Every 3 hours
—	—	39~20	1.5~0.8	Every 6 hours
—	—	19~10	0.7~0.5	Every 12 hours



### 2.3.2 List Print-out

CH	TRG No	ALRM	LEVEL	ALRM	LEVEL2	ZONE	NBS	PARTIAL
1	1CH	N	1.000V	1	OFF	0	0	
2	2CH	F	20.0°C	2	N	01.0°C	3	
3	LP-001	OFF						
4	LN-001	OFF		70	OFF	00	00	00

CH	TRG No	ALRM	LEVEL	ALRM	LEVEL2	ZONE	NBS	PARTIAL
1	1CH	N	1.000V	1	OFF	0	0	
2	2CH	F	20.0°C	2	N	01.0°C	3	
3	LP-001	OFF						
4	LN-001	OFF		70	OFF	00	00	00

CH	TRG No	ALRM	LEVEL	ALRM	LEVEL2	ZONE	NBS	PARTIAL
1	1CH	N	1.000V	1	OFF	0	0	
2	2CH	F	20.0°C	2	N	01.0°C	3	
3	LP-001	OFF						
4	LN-001	OFF		70	OFF	00	00	00

### 2.3.3 List Print-out Description (RD3721 only)

- ① Scale : Recording is performed with a pen corresponding to each channel scale.  
(however only when scale print-out is on in SET UP mode)
- ② Date and time
- ③ Print-out mode setting contents of chart speeds (1) and (2) and phase synchronization (POC)
- ④ Contents of fixed time print-out
  - ALARM : Alarm print-out ON/OFF
  - SCALE : Scale print-out ON/OFF
  - TIME : Time print-out ON/OFF
  - DIGITAL : Measured data print-out ON/OFF
- ⑤ Measuring conditions
  - CH : Channel No.
  - TAG No. : Used instead of the channel No. (up to 7 characters)
  - MODE : Measuring mode
  - RANGE/TYPE/REF/EXPRESSION  
Range/thermocouple type/difference calculation reference  
CH/calculation expression (when "/MATH" is used)
  - SPAN LEFT : Input span left
  - SPAN RIGHT : Input span right
  - SCALE RIGHT : Scaling right
  - FILTER : Input filter frequency (OFF / 0.1 Hz / 1 Hz)
- ⑥ Calculation content (with MATH is used)
- ⑦ Alarm conditions and others
  - CH : Channel No.
  - TAG No. : Used instead of the channel No. (up to 7 characters)
  - ALARM (LEVEL 1 and 2)
  - MODE : H, L or OFF
  - VAL : Alarm set-value
  - RLY : Output relay No.
  - ZONE : Recording range (0 to 100%)
  - ATSS : Automatic span shift ON/OFF
  - PARTIAL : Partial suppression and extension recording limit value
- ⑧ MESSAGE : Contents of messages 0 to 4 (up to 70 characters)
- ⑨ RJC content : External reference junction compensation (EXT RJC)CH (TAG NO.) and reference junction compensation voltage

# 3. FUNCTIONAL DESCRIPTION

## 3.1 Front Panel

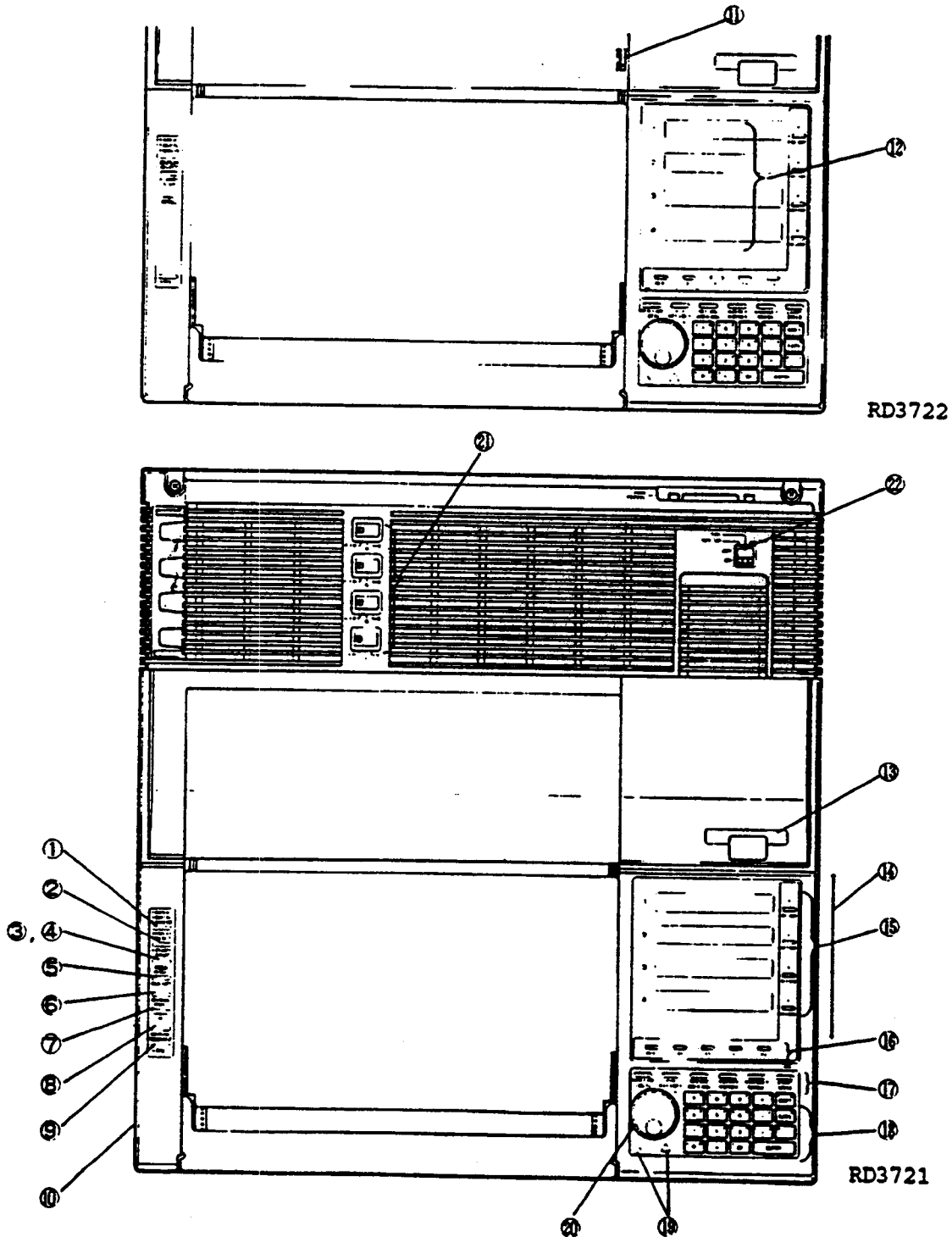
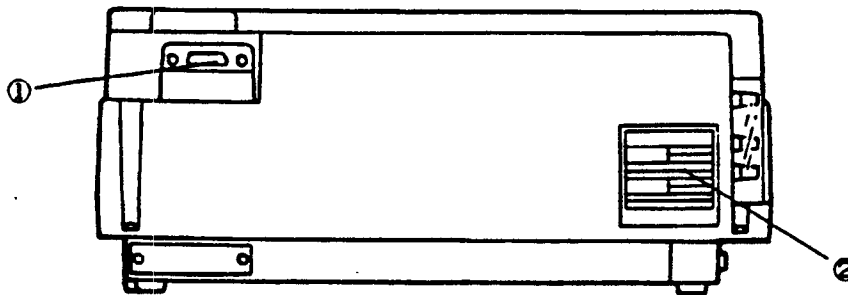

Figure 3.1 Front panel(4-channel model)

- ① **DISPLAY SELECT**  
Used to select measured data, bar-graph and range data.  
Measured data and bar-graph are about 1 second display renewal intervals.
- ② **CHART START**  
Starts/stops the chart feed. The LED lights up when the chart is being fed.
- ③ **FEED**  
Feeds the recording chart.
- ④ **REROL**  
Press after the SHIFT key enabled only when the reroll function is provided (SET UP setting is also required). The recorder starts the chart reroll.  
To stop the chart reroll, repress the FEED or REROL key.
- ⑤ **PEN LEFT (RD3721 only)**  
Used to raise/lower the pens simultaneously. Setting the RECORD keys to ON/OFF allows the pens to be raised/lowered individually.
- ⑥ **MANUAL PRINT (RD3721 only)**  
Prints out measured data when this switch is pressed. For analog recording, all the channel measured data is printed out continuously at high speed in about 1.5 seconds.
- ⑦ **LIST (RD3721 only)**  
Prints out the present setting state. Further, each channel's scale is traced by a corresponding pen.
- ⑧ **MANUAL MESSAGE (RD3721 only)**  
Prints out the setting conditions of Message (0). (Up to 70 characters)  
Note) The print-out of messages (1) to (4) is started by external contact input (option). Using communication function (option), print-out is possible.
- ⑨ **POC (Pen Offset Compensation)**  
Used to turn phase compensation ON/OFF(not provided with the one-pen model). When phase compensation is set to ON, the LED lights up, and when it's set to ON/OFF, the time and the ON/OFF mark are printed out.
- ⑩ **POWER Switch**  
Turns the power supply ON/OFF.
- ⑪ **PEN lift lever (RD3722 only)**  
Note) During the chart reroll, the pens are lifted automatically (RD3721 only)
- ⑫ **Display Units**  
Equipped with easy to read fluorescent display tubes which are used to display and set data. A display unit consists of 20 characters/line, and the number of display lines is the same as the number of input channels. other than tow lines for one-pen recorder.
- ⑬ **IC Memory Card Insertion Slot**  
Used to insert a set value memory card (attached) or a set value and data memory card (option).
- ⑭ **Drawer**  
The operation guide, pens and ribbon cassettes may be stored.
- ⑮ **RECORD**  
Sets recording to ON/OFF. Measurement continues even if it is set to OFF and therefore, display and communication output (option) are available. When this is set to OFF, The Pens move to the right end and raised automatically.
- ⑯ **Function Keys**  
F1 to F4 : Function keys corresponding to setting displays (menus)  
Next : A NEXT key for menus (display scroll)

- ⑩ **Function Keys**
- CHART SPEED : Selects chart speed.
- ◀ RANGE ▶ : Allows a measuring range to be set for each channel by using the setting knob. Pressing this key after the SHIFT key enables you to set any measuring scale, execute scaling or set the filter frequency by using the ALPHANUMERIC and ENTRY keys.
- RANGE
- ◀ ZERO ▶ : Enables you to adjust the pen's zero position for each channel with the setting knob. Pressing this key after the SHIFT key allows you to adjust the span.
- ◀ SPAN ▶
- RECORD : Sets the recording zone arbitrarily by moving the pen position.
- AREA ADJ
- AUX : Sets alarms, tag numbers, messages and the clock.
- KEY LOCK : When this key is pressed successively to the SHIFT key, the keys from ⑩ to ⑭ can be locked.
- MEM CARD : A setting key for use with an IC memory card.
- LOCAL : When this key is pressed successively to the SHIFT key, sets the mode in LOCAL mode when the GP-IB is used.
- ⑪ **ALPHANUMERIC Key** : Sets various digital data and characters.
- ENTRY key : Enters the setting contents.
- SHIFT key : Pressing this key once enters the characters at the upper left of the ALPHANUMERIC key. Pressing this key twice enters the characters at the upper right of the ALPHANUMERIC key. In the range program mode and at span adjustment, select a function key after this key has been pressed.
- CAPS key : When the LED at the upper right is OFF, uppercase letters are available and, when it is ON, lowercase letters are available.
- ⑫ **Cursor Key**  
Shifts the cursor on the setting display panel up and down.
- ⑬ **Setting Knob** : Sets range and chart speed. When the setting knob is used, the LED on the upper right lights up. Fine to coarse adjustment for ZERO SPAN adjustment and RECORD AREA ADJ is available by changing the rotation speed.
- ⑭ **Guard Terminal / B Terminal Selector Switch**  
select Guard terminal or B terminal.
- G : Guard terminal is selected.
- B : When RTD input is used, set to B terminal
- G-LO : G (Guard) terminal and LO (negative) terminal are short circuited.
- ⑮ **CAL / SET UP Switch**
- CAL : Calibration adjustment switch — used only when the recorder is calibrated. This switch should not be touched by the uses.
- SET UP : Used to change the chart speed unit from mm to inches, etc (by setting it to ON)

## 3.2 Rear Panel



## 3.3 side Panel (Left side)

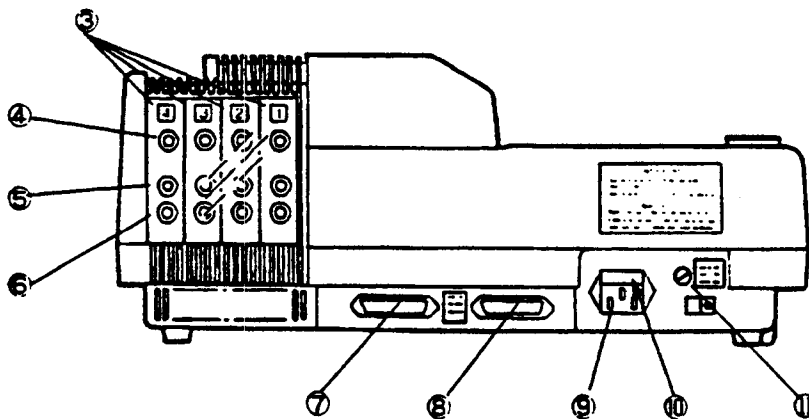

Figure 3.2 Rear Panel (4-channel model)

- ① **GP-IB/RS-232C Connector (Option)**  
GP-IB or RS-232C communication interface connector.
- ② **Nameplate**  
Check the Model and supply voltage inscribed on the nameplate.
- ③ **Input Module**  
One, two, three or four modules are built into the recorder as specified.
- ④ **Guard Terminal or B-terminal**  
Used as a guard terminal for voltage or thermocouple input and as a B-terminal for RTD input.
- ⑤ **Positive Terminal**  
Used as a positive terminal for voltage and thermocouple inputs and as an A-terminal for RTD input.
- ⑥ **Negative Terminal**  
Used as a negative terminal for voltage and thermocouple inputs and as a B-terminal for RTD input.
- ⑦ **Alarm Connector (Option)**  
An alarm output (4 points) connector
- ⑧ **Remote Control Connector (Option)**  
The chart speed can be controlled using external control signals.
- ⑨ **Power Supply Connector**

- ④ Fuse Holder (spare fuse also contained)
- ④ Ground Terminal

**This Page is Intentionally Blank.**



## **4. INSTALLATION**

### **4.1 Installation Location**

Install the recorder where :

- (1) Mechanical vibration is low.
- (2) There are no corrosive gasses or where concentrations are low.
- (3) Temperature is stable and near a normal temperature of 23°C.
- (4) There is no direct, high radiation heat source.
- (5) Magnetic field effects are low, and
- (6) Humidity is not too high or too low. Ideally it should be kept to about 55%.

### **4.2 External Dimensions**

Fig. 4.1 (next page) shows the external dimensions.

Unit : mm

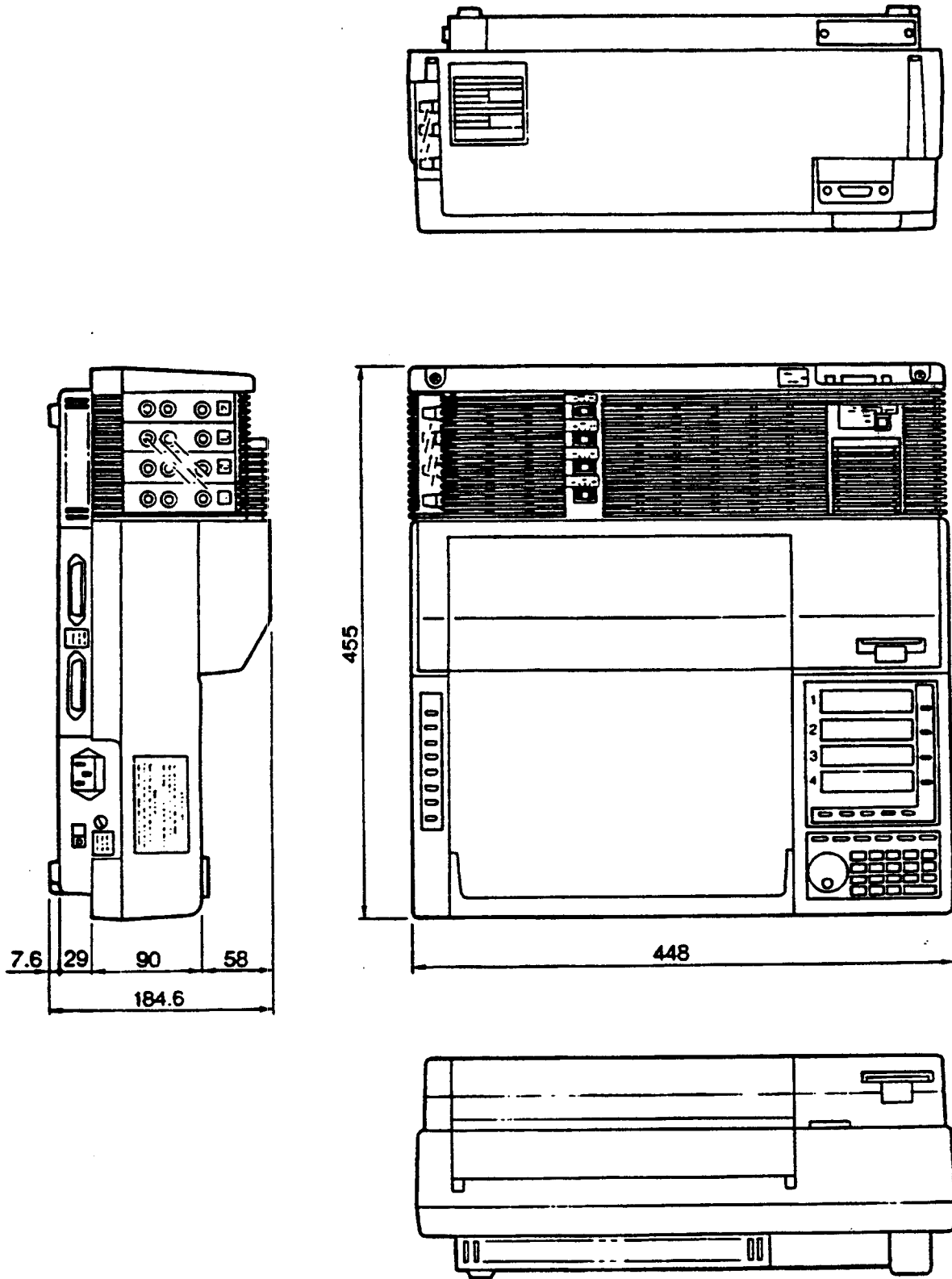

Figure 4.1 Dimensions

## 5. WIRING

### 5.1 Power Supply

With the power switch OFF, connect the power supply cord to the power supply connector on the rear panel shown in Figure. 3.2.

### 5.2 Input

Connect the input terminals on the recorder rear panel as described below.

#### 5.2.1 DC Voltage and Thermocouple

The input terminal consists of three terminals; positive (H), negative (L) and guard (G).

- (1) When the recorder is used in a laboratory or in a high-voltage range, connect an input line between terminals H and L with terminals L and G shorted (Fig. 5.1).

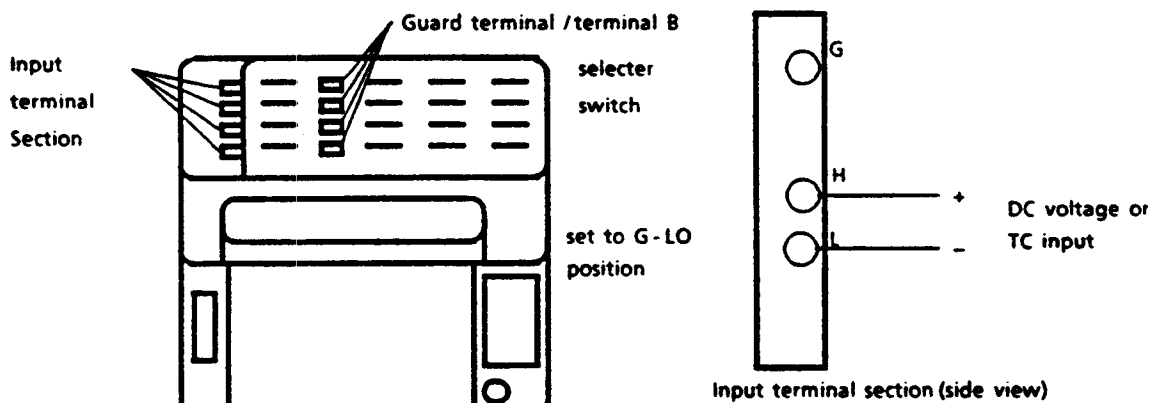

Figure 5 - 1

#### Instructions for high sensitive and temperature measurements

- (1) The change in the temperature difference between the recorder interior and exterior may cause a zero drift, so when installing the recorder the following instructions must be observed.
  - ① Use the recorder at an area where the recorder is hardly to be affected by the wind from an air conditioner supply opening.  
(when starting or stopping the air conditioner, the ambient temperature considerably changes and the recorder is influenced by the thermoelectromotive force).
  - ② Use the recorder in an area where the temperature change at day and night is small by avoiding the area where the temperature changes abruptly such as windy place or area subject to direct sunlight.
  - ③ To keep the terminal temperature stable, always use the terminal cover supplied with the recorder. Avoid using the recorder with the air vent of the case closed.

- (2) When wiring input terminals, if metal tips or wiring materials other than copper are used, several  $\mu\text{v}$  thermoelectromotive force may be generated, so for high sensitive measurement be sure to use copper wire.
- (3) When measuring thermocouples, if large capacity tip type terminals are used, the temperature at terminals changes and reference junction compensation error may occur. For connecting the thermocouples, thermocouple element wires must be connected directly.

(2) For high-sensitivity measurement, warm up the recorder for at least an hour. If the recorder is likely to be affected by noise, etc. in high-sensitivity measurement, or if it is likely to be affected by common mode voltage, use the guard (G) terminal and when wiring, use shielded cables as where as possible. Figs. 5.2 thru 5.4 show general wiring examples.

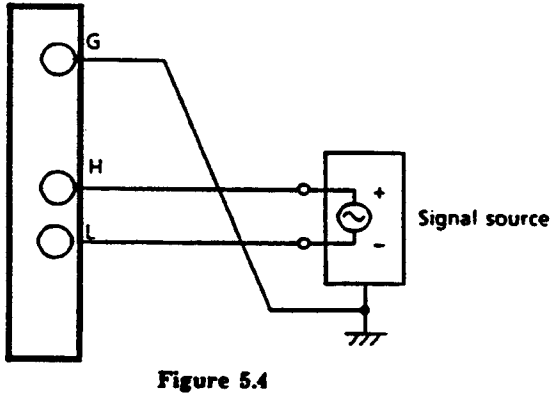
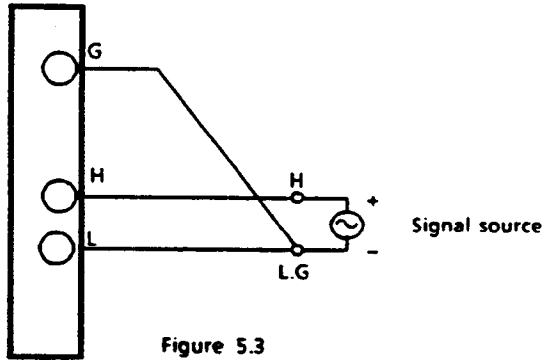
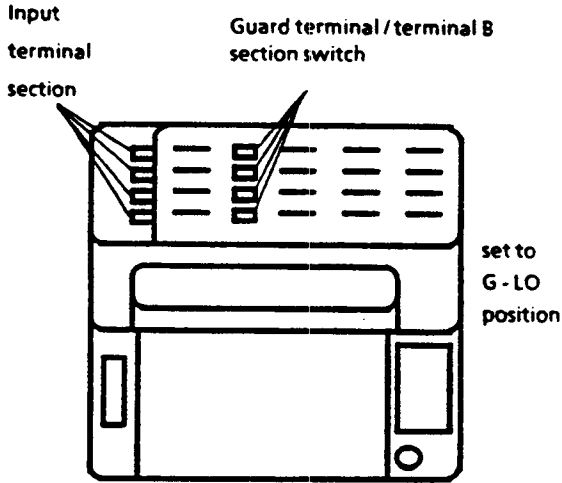
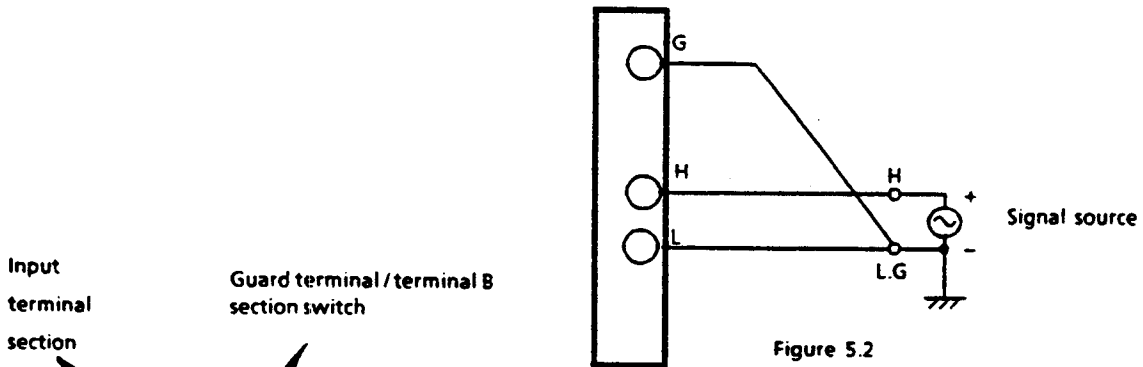

**Notes:**

1. The recorder should be grounded for any of the above cases.
2. The guard terminal function is not provided for low-sensitivity models.
3. For the high-sensitivity range use as short an input cord as possible.
4. Maximum input voltage is 250 V DC. If the voltage exceeds 250 V, the input circuit may be damaged.
5. Allowable signal source resistance is  $1\text{K}\Omega$  or less for DC voltage and thermocouple input. If it is greater, take a bias current of about 4 nA into account. In this case, 4 nA (signal source resistance) is added to the input voltage, and the voltage drop will be in error.
6. Maximum common mode voltage is 250 V AC rms. If it exceeds this value, an error may occur or the input circuit may be damaged.

**5.2.2 RTD Input**

Use a three-wire RTD.

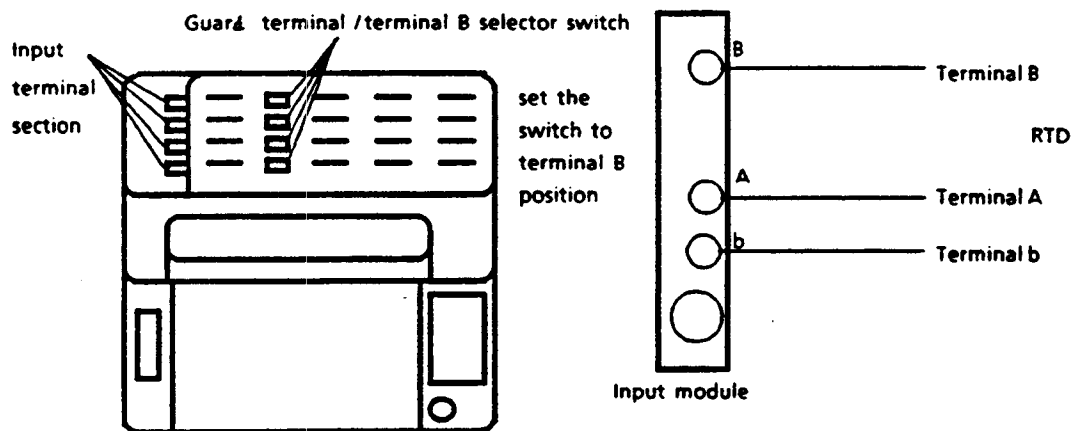

**Figure 5.5 RTD Input Wiring**

**Notes:**

1. Balance the three lead wire resistance lines for RTD input. Further, the following error is due to lead wire resistance.
 

Pt 100, Ni 100	:	0.1°C at 10 Ω.
Pt 50	:	0.1°C at 5 Ω.
2. Maximum common mode voltage is 250 V AC rms. If it exceeds that value, an error may occur or the input circuit may be damaged.

**This Page is Intentionally Blank.**

## 6. OPERATION

### 6.1 Operating Procedure Flow Chart

General setting and operating procedures for the RD3721/RD3722 are described in the following flowchart.

Two types of setting modes: standard and program modes, are available. When only the functions equivalent to those provided by conventional analog pen recorders are used, only the standard mode settings are required. When performing applied operations, make the settings in regular sequence in the program mode.

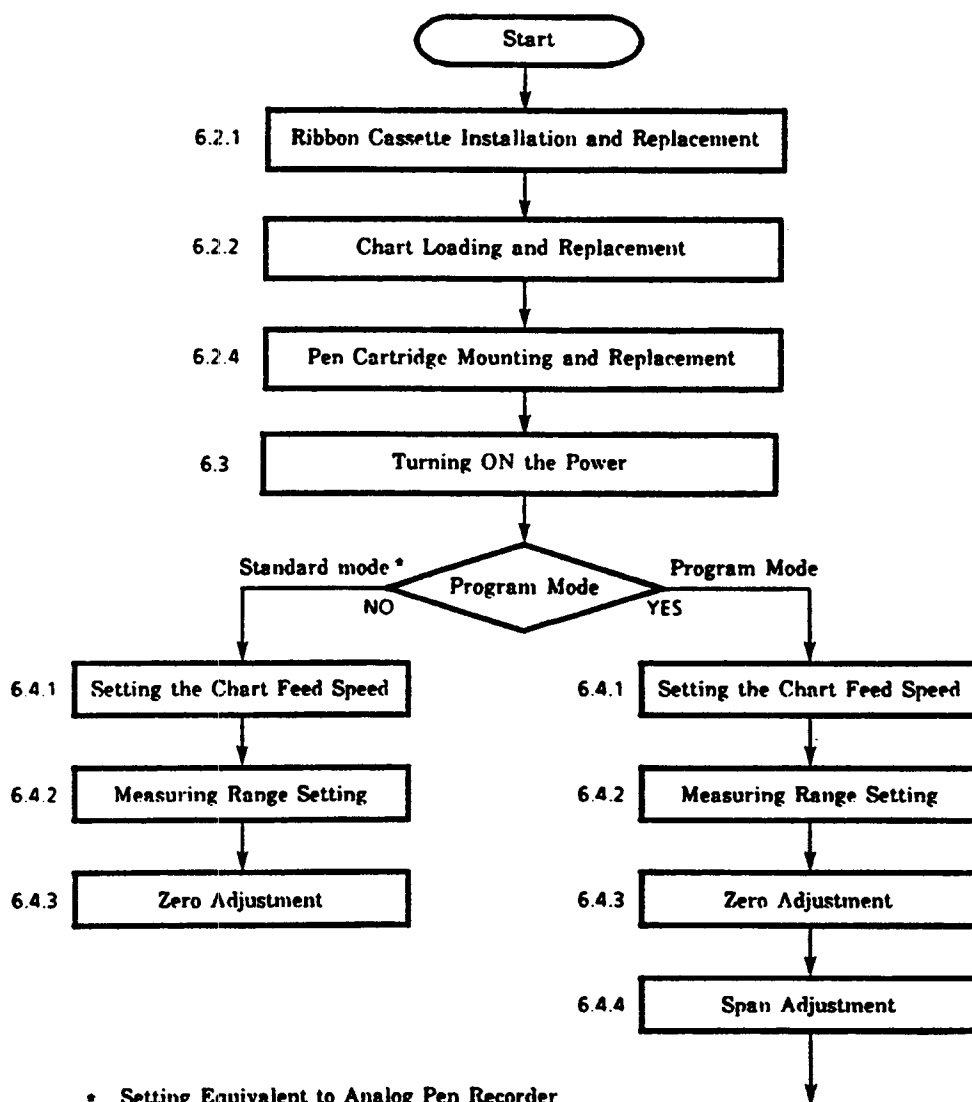

**Notes :**

1. No setting is required for unrequired items :  
only the necessary items need be set.
2. When initializing setting information, see Section 6.4.12, Set value Information.
3. When using an IC memory card, see Section 6.4.13, IC memory Card.
4. When changing initially set values such as °C/°F see Section 6.4.14, SET UP Mode.
5. When referring to the whole contents of the program, see Section 6.4.15, Program Table Setting.
6. See Section 6.4.16, Error Messages.

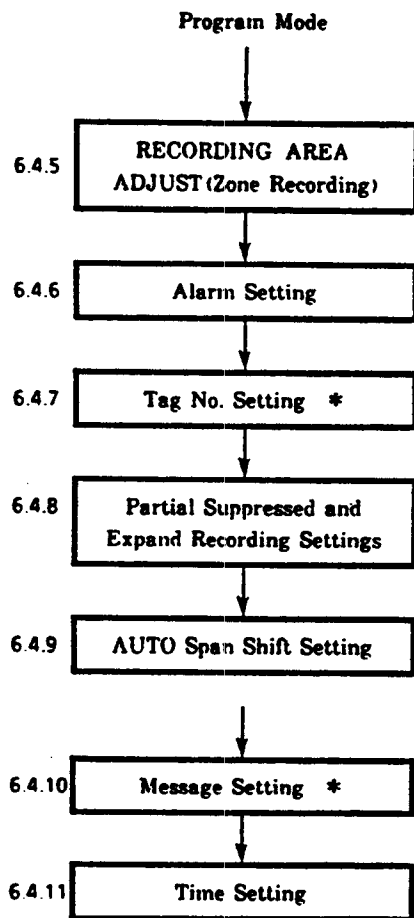

\* RD3721 only



## 6.2 Preparation

### 6.2.1 Ribbon Cassette Installation and Replacement (RD3721 only)

The ribbon cassette must be replaced with the power turned OFF.

- (1) Lift the metal chart holder fitting at the front section as shown in Figure 6.1.
- (2) While lifting the metal chart holder fitting, lift the chart tray slantly and pull it to remove from the recorder.
- (3) Move the printer carriage to the extreme left, and all pens on the pen carriages to the extreme right.

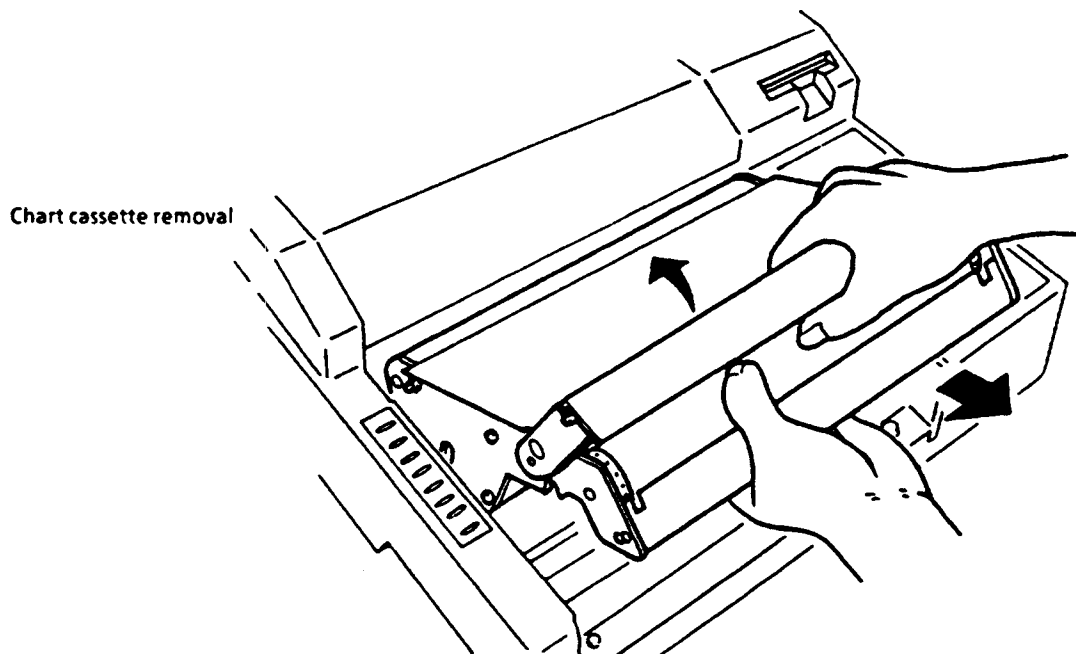

Figure 6.1

- (4) Pull out the ribbon slightly from the ribbon cassette and install the ribbon onto the two guide pins. At this time, the ribbon adjustment knob must face down. (Figure 6.2)
- (5) Move the ribbon cassette approx. 20 mm to the right beyond the printer carriage with the ribbon passed through the two guide pins. (Figure 6.3)
- (6) Move that ribbon cassette back by approx. 10 mm toward the guide pins. Be sure to install the ribbon to the guide roller by dropping the slackened ribbon on the roller section so as to cover the front and rear of the printer head. (Figure 6.4)
- (7) Bring the ribbon cassette to the middle of the recorder, then change it from the right hand to the left hand to prevent the right hand from coming into contact with the pen carriage. Insert half of the cassette into the square hole on the right side plate and push the angled section at the end of the cassette. (Figure 6.5)
- (8) Push the cassette into the square hole on the right sideplate until it latches with a click. (Figure 6.6)
- (9) When the slack ribbon falls below the wire dot printer, repeat the above procedure to remove ribbon slackening.

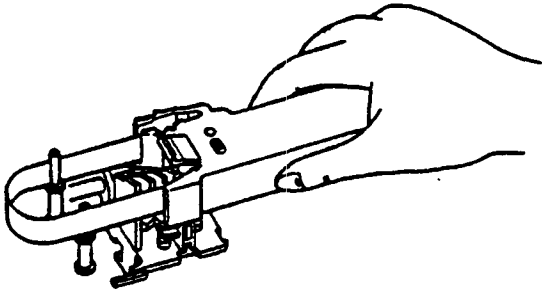

Figure 6.2

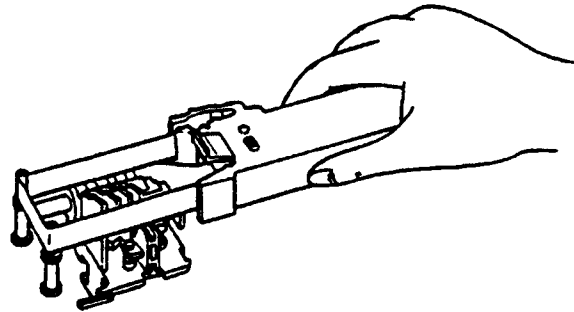

Figure 6.3

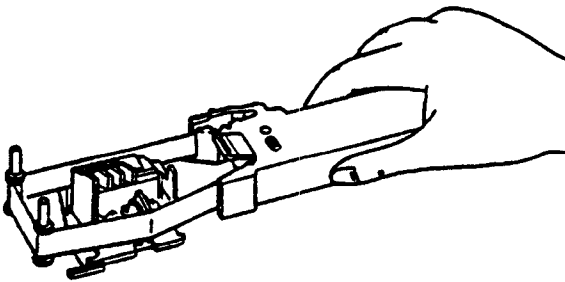

Figure 6.4

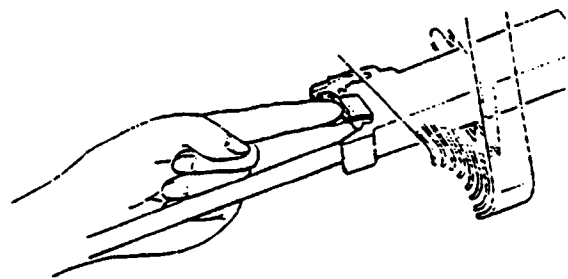

Figure 6.5

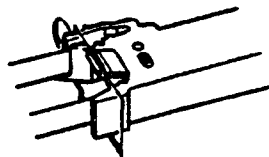

Figure 6.6

- (10) When replacing the ribbon cassette, pinch the cassette latchlevers, then pull the cassette out of the hole. (Figure. 6.7) Use the same procedure when installing new cassettes.
- (11) Lift the metal chart holder fitting at the front section, lift the projections on the right and left sides of the chart tray into the notches in the recorder to install the chart tray into the recorder. (See Figure. 6.8)

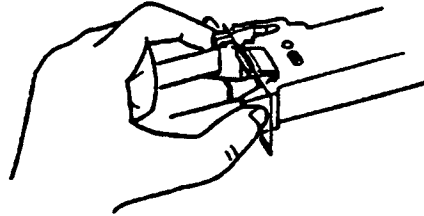

Figure 6.7

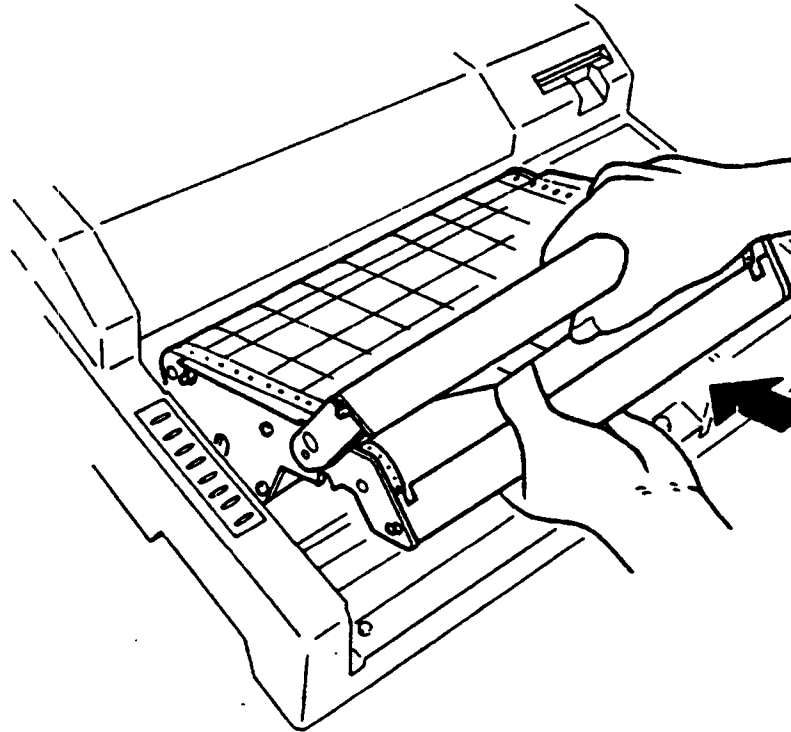

Figure 6.8

### 6.2.2 Chart Loading and Replacement

Chart replacement can be performed whether the power is turned on or not.

<z-fold chart>

- (1) Ruffle both ends of the chart so that the chart sheets can be fed one by one. (See Figure. 6.9).
- (2) Lift the metal chart holder fitting at the front position and remove the chart tray from the recorder (See Figures. 6.1).
- (3) Turn the removed chart tray upside down so that the flat - bed side faces downwards. (See Figure. 6.10)

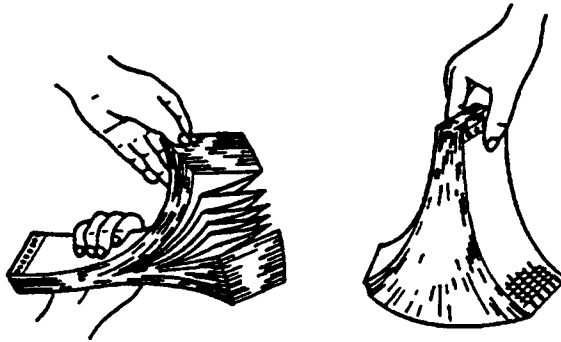

Figure 6.9

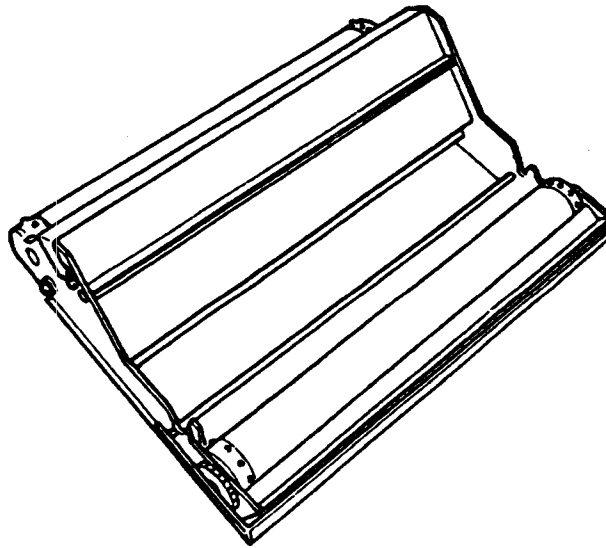

Figure 6.10

- (4) While pressing both right and left projections of the metal chart holder fitting at the rear section of the chart tray toward inside, lift it in the direction of the arrows with your hands and turn the metal chart holder fitting toward you. (See Figure 6.11)
- (5) Set the chart so that the round holes in the chart are positioned at the right and the chart end with both edges cut off is positioned in the forward. (Figure. 6.12)

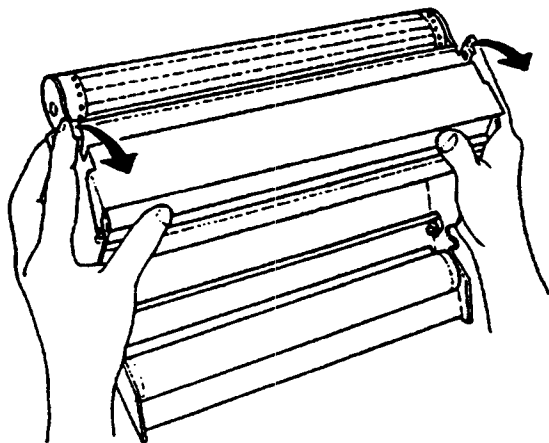

Figure 6.11

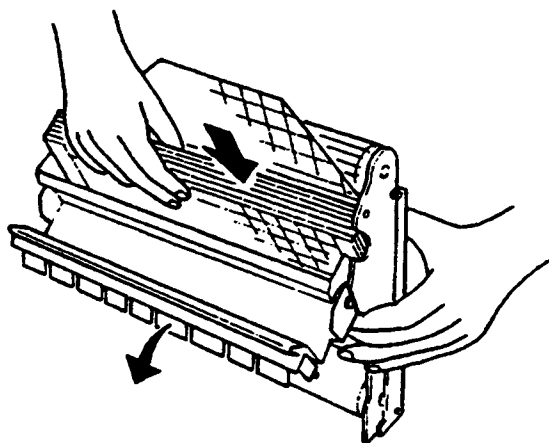

Figure 6.12

- (6) To install the chart in parallel with the sprockets at both sides, align the ruled line indicated to the chart right and left edges at 5cm intervals with the follows (indicated with the arrow marks) located on the right and left side panels of the cassette. At this time, pull the chart end to the center of the chart tray table (See Figure. 6.14).
- (7) Reinstall the metal chart holder fitting in place (attach). In this case, while taking care not to deform the chart end, the metal projections on the right and left sides of the chart holder at the rear section should be matched with the oval holes on the right and left sides panels of the cassette security.

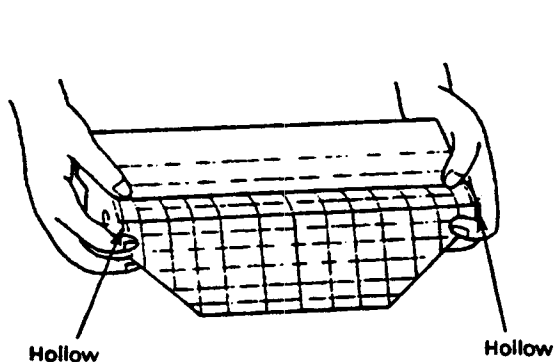

Figure 6.13

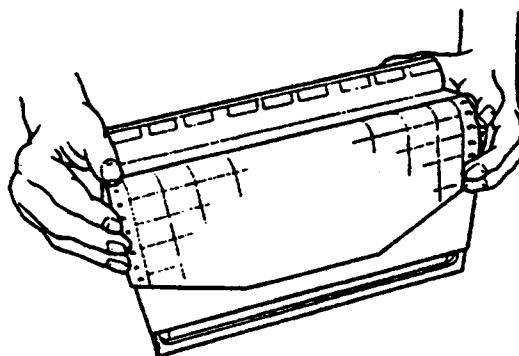

Figure 6.14

- (8) Lift the metal chart holder fitting at the front section with your hands, fit the projections on the chart tray into the notches in the notches in the recorder. (See Figure 6. 8)

At this time, pass the chart through under the metal chart holder fitting and mate the right and left chart holes with sprockets and put down the chart holder at the front section (See Figure 6.15)

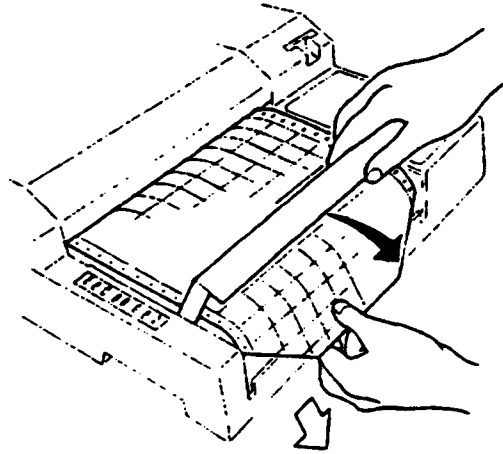

Figure 6.15

- (9) Turn ON the power and press the FEED pushbutton on the left front panel of the recorder to feed more than three folded portions of the chart to the chart receiving section at the recorder front. In this case, make sure that the chart is feeding normally. If the chart does not feed correctly, repeat the procedure from step (2) above.
- (10) When the chart is nearly finished, a vermilion band indicating "RENEW CHART" appears on the chart. When this appears, install a new recorder chart.
- (11) When the chart is finished, the CHART END indicator lights up at the top of the front panel. When this happens, replace the chart with a new one by following the procedure described in steps (1) to (9) above.

**Note:**

Always use recorder roll chart paper OMEGA part number RD3720-RP. Use of other paper may present problems.

<Roll chart>

The roll chart can be used when the optional / ROL or / REROL is attached.

- (1) Install a roll chart into the special stock roller. (See Figure 6.16)

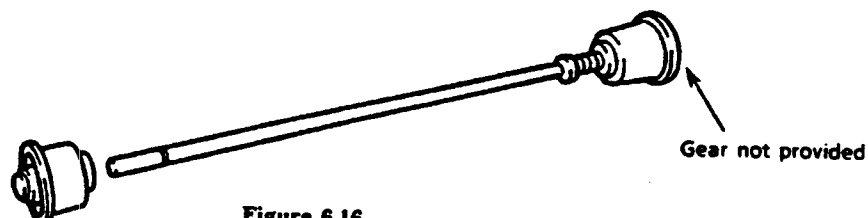

Figure 6.16

- \* Gear is provided with the stock roller for the optional / REROL, to be attached to the chart reroll unit.

Pull the flange that can be removed from the stock roller shaft out of the shaft.  
 Insert the shaft through the roll chart roller with the chart oval holes located at fixed flange side.

Mate the removed flange with the chart roller notches and reassemble the flange (See Figure 6.17)

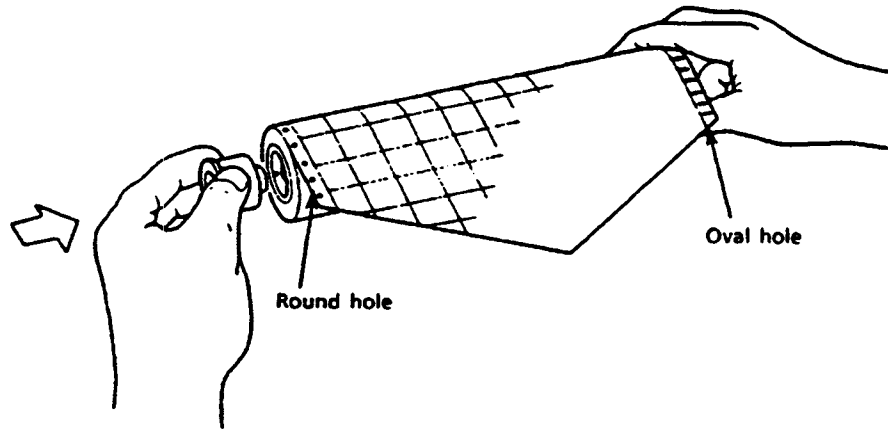

Figure 6.17

- (2) Lift the metal chart holder fitting at the front section of the recorder to remove the chart tray (See Figure 6.1).
- (3) Remove the metal chart holder fitting at the rear section (when the roll chart is used, this is not used)  
 Push up the rear metal chart holder fitting in the direction **(A)**.  
 Next, apply force lightly in the direction **(B)** and it can be easily removed. (See Figure 6.18)

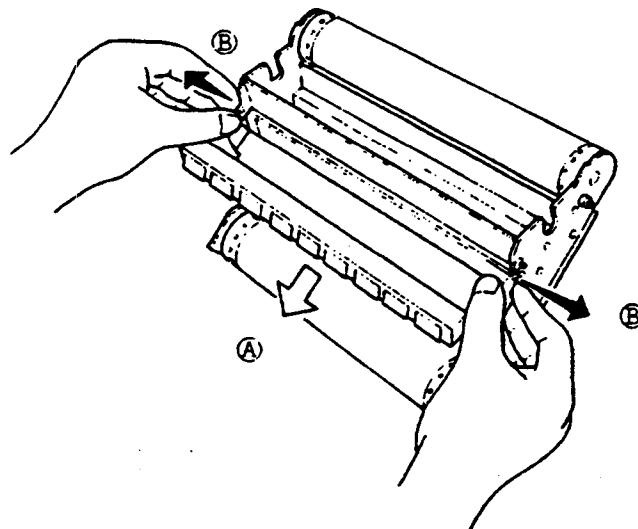

Figure 6.18

- (4) While pressing both stock roller shaft ends (bearings) toward inside concurrently insert the stock roller shaft ends into the chart tray guide notches (See Figure 6.19). When each end of the stock roller shaft reaches the notch bottom, weaken the pressure and confirm that the both end bearings are securely inserted the notches (Figure 6.20).

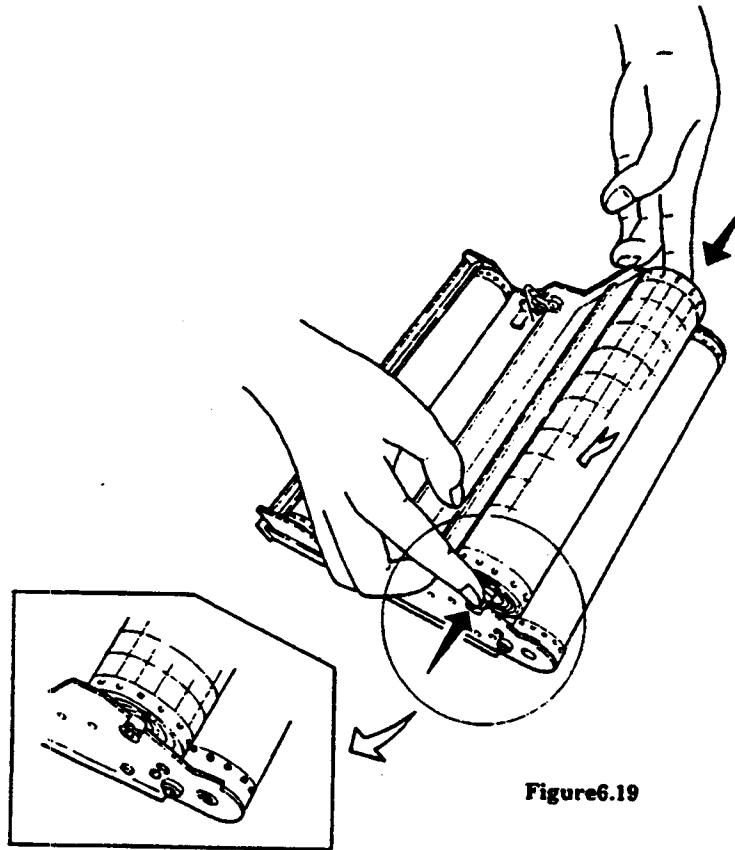

Figure6.19

Figure 6.20

- (5) Mate the holes of the chart at the right and left edges with the sprockets so that the chart is installed in parallel with the sprockets and pull the chart and to the center of the chart tray table (See Figure 6. 14)
- (6) Hereinafter the procedure is the same as steps (8) to (11) for the Z-fold chart described before.



### 6.2.3 Chart Reroll Unit (/REROL) Attachment (Option)

1. Remove the chart cassette (See Figure 6.1)
2. Mate the U-shaped groove parts at the right and left bottom of the chart reroll unit metal attachment with the projections to the recorder side panels (Figure 6.21)

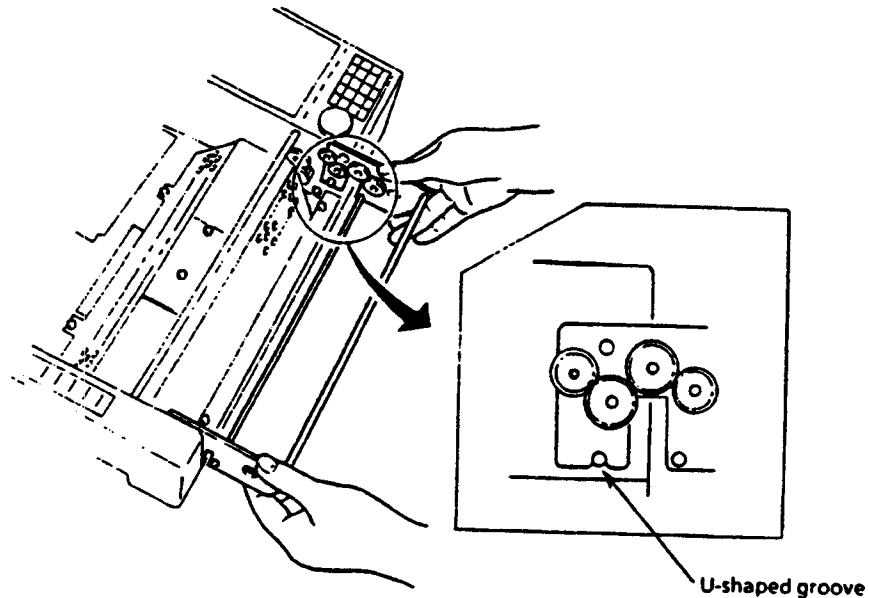

Figure 6.21

3. Using a flat blade screwdriver, attach the chart reroll unit metal attachment to the mainframe with the two special screws supplied with the chart reroll unit (See Figure 6.22).

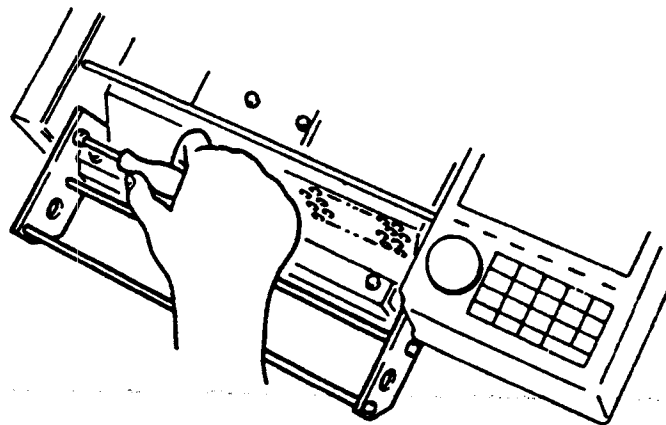
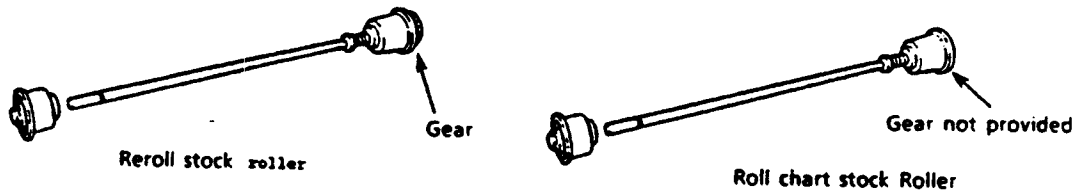

Figure 6.22

4. Assemble a roll core to the chart reroll stock roller.



(Note) As the gear is not provided with the roll chart stock roller, chart reroll is disabled even if it is mounted on the chart reroll unit metal attachment.

5. Mount the stock roller 4 on the chart reroll unit metal attachment from the direction shown by the arrow mark (Figure 6.23)

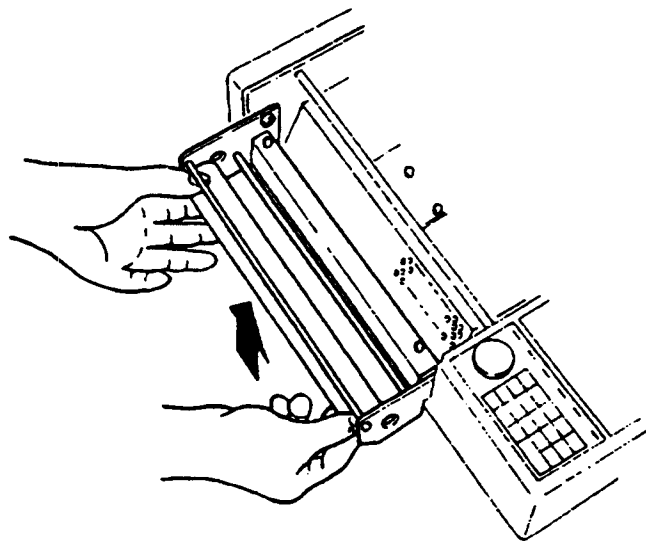

Figure 6.23

6. Install the roll chart in the reroll chart in the reroll chart cassette (See Figure 6.24) and install the reroll chart cassette in the recorder. (See Figure 6.25)

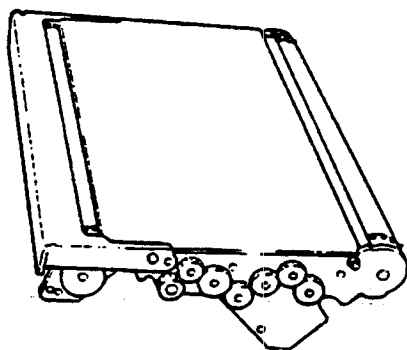

Figure 6.24

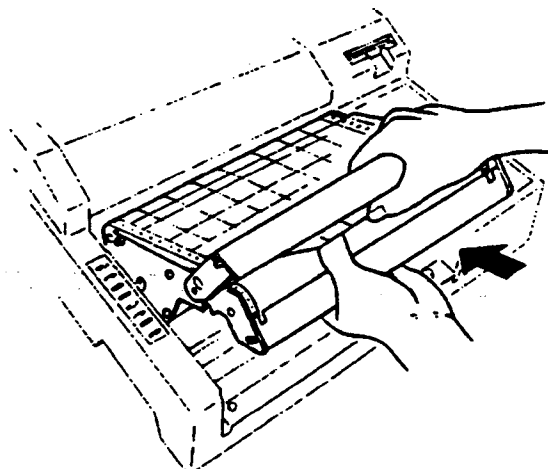

Figure 6.25

\* Gears are provided with the reroll chart cassette.

7. Pull the roll chart for about 10cm from the chart table end and mate the holes of the chart at the right and left edges with the sprockets (Figure 6. 26).

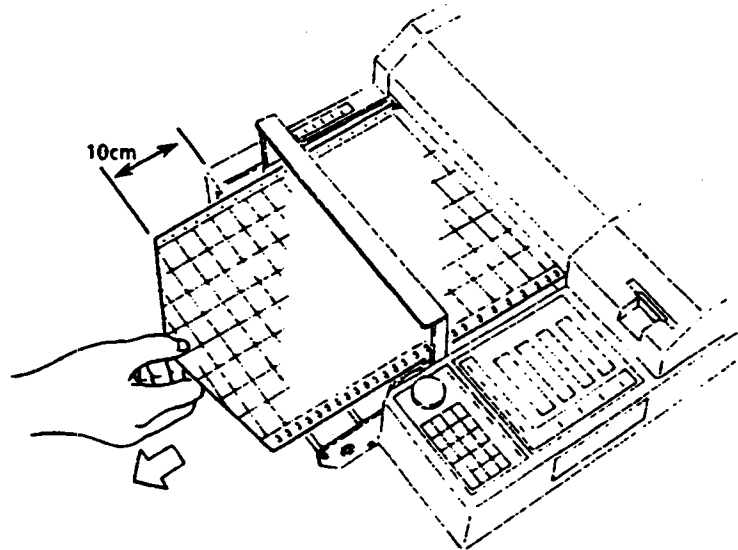

Figure 6. 26

8. As shown in Figure 6.27, thread the roll chart under the front metal chart holder fitting, and using a piece of cellophane tape, stick the chart end on the roll core.

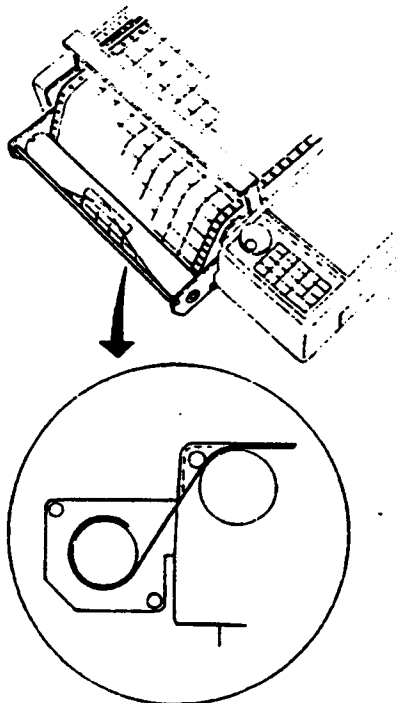

Figure 6. 27

- ※ To remove the stock roller, push the left side of the roller with fingers at the outside of the winder attachment bracket.

### 6.2.4 Pen Cartridge Mounting and Replacement

Replace pen cartridges with the power supply OFF.

- (1) Remove the cap from the pen cartridge and insert it into the drawer at the right side of the product for storage.

- (2) Install a pen cartridge to the holder.

Make sure that a pen corresponding to the pen number and color shown on the pen holder has been installed. Note, however, that pens with different numbers and colors can also be mounted.

When installing the cartridge, insert it into the holder so that the projection at the rear of the cartridge is positioned below the pen cartridge shaft, then press it onto the holder (Figure. 6.28).

Cartridge installation is complete when a locking sound is heard and the pen is flush with the holder.

- (3) Pens can be removed from the pen holder by lifting the center portion of the cartridge upward (Figure. 6.29).

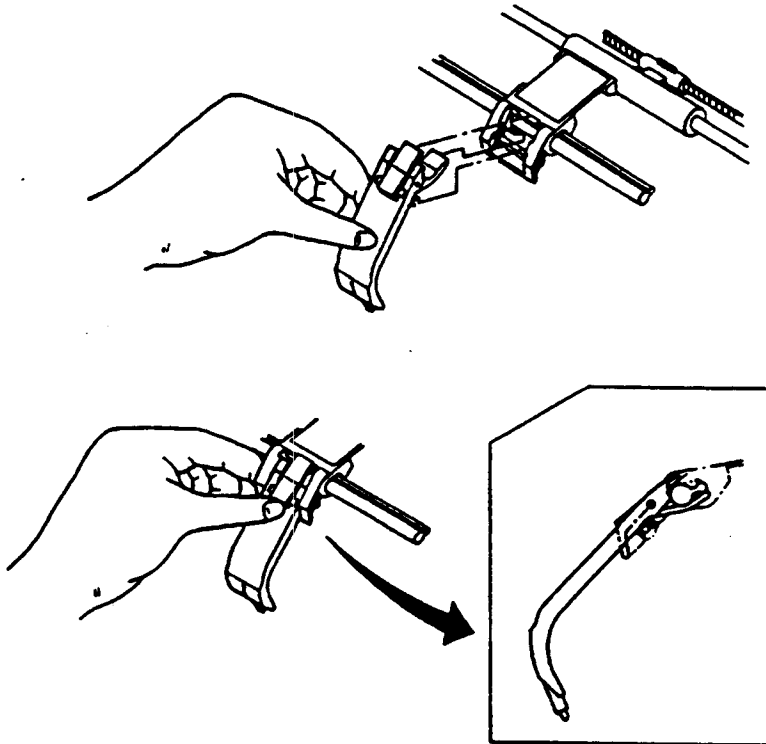

Figure 6.28

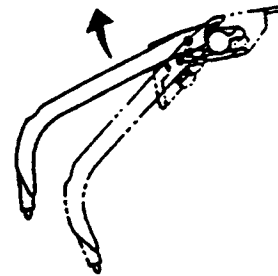

Figure 6.29

- (4) There are three types of pens: standard, high-speed (special order) and low-speed (special order).

A selection guide showing how to distinguish between them is set out below.

Standard	:	is used for normal recording with a pen recording speed of about 800 mm/s or less Color of the bracket at the rear of the pen : Gray
High-speed type (Special order)	:	is used for recording high-speed phenomenon requiring a pen recording speed of more than 800 mm/s color of the bracket at the rear of the pen : Blue
Low-speed type (Special order)	:	is used for low-speed feeding with a chart feed speed of about 100 mm/h or less Color of the bracket at the rear of the pen : White

**Notes:**

1. Forcing the pen holders right and left with the power supplied may damage their function.
2. If the recorder is not used for a long time, remove the pens and always cover them with pen caps.  
When the pens are stored in a packing bag and sealed securely, storage life will be lengthened.
3. A pen cartridge has latch sections at its right and left.  
Make sure that both latches are firmly set and that the cartridge is flush with the holder.

Note that an inclined pen cartridge will not record correctly.

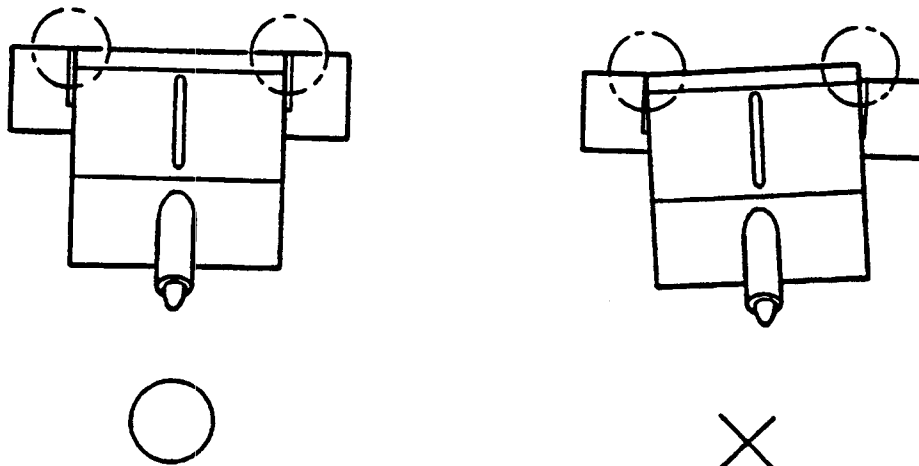

## 6.2.5 Battery Replacement

Set data protection batteries are installed prior to delivery.

- (1) If the MAIN BAT error message is displayed while the power is turned on replace the batteries.
- (2) Remove the chart cassette (See Figure 6.1).
- (3) Turn the power switch OFF, using a Phillips screwdriver, remove total of five screws - two on recorder front, two on recorder rear and one on the right side panel (See Figure 6.30).
- (4) Remove the recorder top cover upward. There is lithium battery pack on the right side when viewed from the front (Figure 6.31).  
The battery pack incorporates lead wires and connectors.
- (5) Remove the battery from the recorder using a phillips screwdriver and then take the leads and connector off the battery.
- (6) Mount a new battery (Part NO : B9588ZB) onto the connector of the main board from which the used battery was removed.
- (7) Fix the battery in place with a screw.
- (8) Install the cover to complete replacement

(Note) Replacing the battery erases the set data. If the set data is required, store it in an IC memory card (For storing the set data see section 6.4.13).

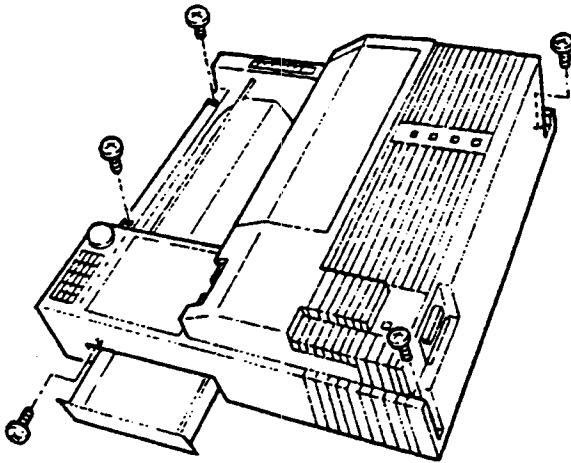

Figure 6.30

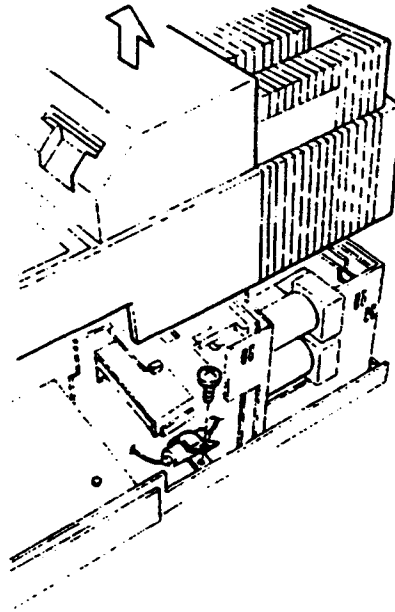

Figure 6.31

### 6.2.6 Battery Installation and Replacement (from the IC Memory Card)

The following describes the IC memory card set data protection battery installation and replacement procedure.

- (1) Hold the IC memory card so that the side which shows the part number faces upward.
- (2) Place your finger nail in the battery holder groove and pull it forward to take out the battery holder (Figure 6.32).
- (3) Insert a new battery (B9586JU or B9586JV : optional) into the battery holder.
- (4) Insert the battery holder into the IC memory card.

This completes battery installation upon delivery. The following describes how to replace the battery.

- (5) While operating the memory card menu, if the error message \*\* CARD BAT \*\* is displayed, the batteries are worn out, so replace the batteries. When the batteries are not installed in the recorder, the battery error cannot be detected.
- (6) The battery should be removed with the recorder power supply set to ON and the IC memory card installed in the recorder. Note that replacing the battery when the power is OFF, or after the card has been removed from the recorder, erases the set data.
- (7) Place your finger nail into the battery holder groove at the near right of the IC memory card to pull out the battery holder.
- (8) Replace the battery with a new one and return the battery holder to the IC memory card.

This completes IC battery replacement.

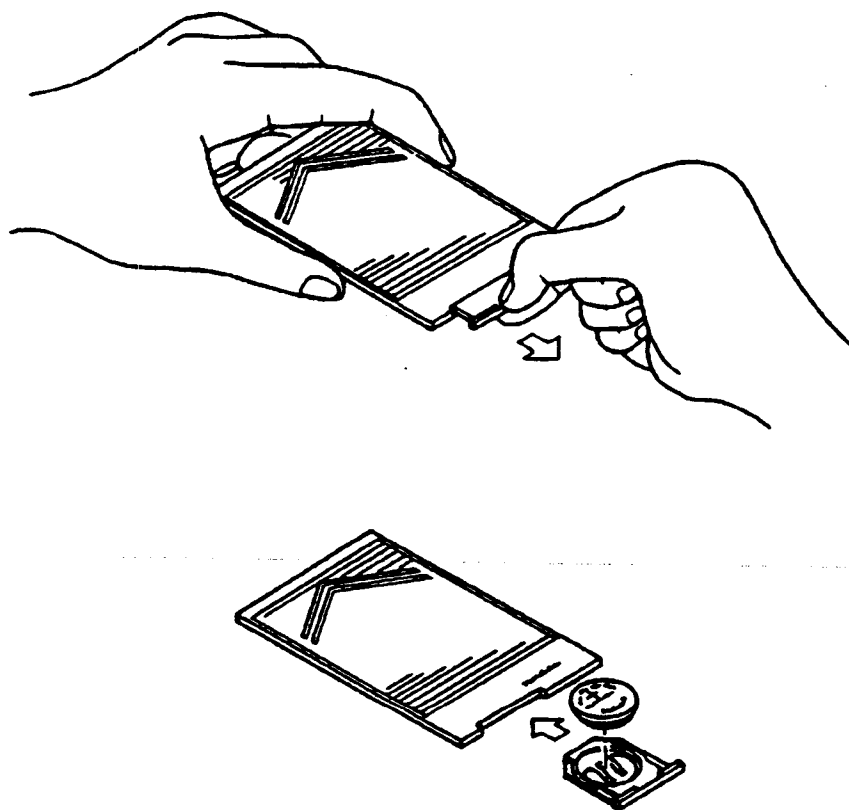













Figure 6.32

## 6.3 Turning the Power Supply ON





Turn ON the power on the front panel. The operation and program keys are set prior to shipment.

### (1) Operation Key

Key	Initial Setting Status
 DISPLAY SELECT	DIGITAL
<input type="checkbox"/>  CHART START	OFF
 FEED REROLL	OFF
 PENLIFT	UP
 MANUAL PRINT	OFF
 LIST	OFF
 MANUAL MESSAGE	OFF
<input type="checkbox"/>  POC	OFF
 MEM CARD LOCAL	LOCAL (with GP-IB)
 AUX KEY LOCK	OFF
<input type="checkbox"/>  RECORD	OFF



## (2) Program Key

Key	Initial Setting Status	
 CHART SPEED	10mm / M	
 RANGE RANGE	MODE	VOLT
	RANGE	200V
	SPAN L	0.00V
	SPAN R	200.00V
	FILTER	OFF
 ZERO SPAN	ZERO	0.00~200.00V
	SPAN	0.00~200.00V
 RECORD AREA ADJ	0~100%	
 AUX	ALARM	OFF
	TAG No.	CH
	MESSAGE	Space
	RCD	can not set
	RAM CLEAR	NO

## 6.4 Setting

### Precautions

- ① Note that the number of display rows differs depending on the number of input channels between the setting panel described here and the actual setting panel.
- ② For setting, always press the keys with your fingers. If nail or pointed tool is used the keys will be damaged.

### 6.4.1 Setting the Chart Feed Speed

Two modes; standard and program, are used in setting chart feed speed.

#### (1) Standard Mode

**Function** : Selects the chart feed speed corresponding to that of analog recorders via the function keys and setting knob.

**[Key operation]**

**[Setting display]**

**[Description]**

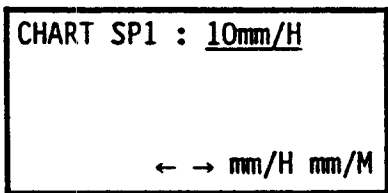

Press the CHART SPEED function key. If the speed is to be changed from mm/M to mm/H, press function key F3.



Set chart feed speed with the setting knob. Chart feed speeds that can be selected in the standard mode are shown in Table 6.1.

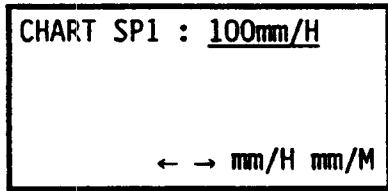

Pressing the ENTRY key twice completes setting. Then, the display returns to the original status.



Because setting becomes valid when the key is pressed once, press the ENTRY key to check to see if the chart is fed at the rate set.







**Table 6.1 Standard Mode Chart Feed Speed**

mm / min mm / h	10	12	20	30	50	60	75
	100	120	150	200	300	500	600
	750	1000	1200				
*inch / min inch / h	0.5	1	1.2	2	3	5	6
	10	12	20	30	45		

\* For transferring to inch series, see Section 6.4.14 Set Up Mode.

## (2) Program Mode

**Function** : Allows the recorder to set chart feed speed in 1 mm units by pressing the ALPHANUMERIC key.

[Key operation]	[Setting display]	[Description]
   	CHART SP1 : <u>10</u> mm/H  ← → mm/H mm/M	<p>Press the CHART SPEED function key. To change the speed from mm/M to mm/H, press function key F3.</p> <p>Set the data (digits) you desire by pressing the ALPHANUMERIC key.</p>
 	CHART SP1 : <u>100</u> mm/H  ← → mm/H mm/M	<p>Pressing the ENTRY key twice completes setting. Then, the display returns to the original status.</p> <p>(Because setting becomes valid when the key is pressed once, press the ENTRY key to check to see if the chart is fed at the rate set.)</p>

### 6.4.2 Measuring Range Setting

Two modes, standard and program, can be used in setting the measuring range.

#### (1) Standard Mode

Function :

Selects the measuring range corresponding to that of analog recorder via the function keys, cursor keys and setting knob.

[Key operation]

[Setting display]

[Discription]



1CH	200V	0.00~200.00
2CH	200V	0.00~200.00
3CH	200V	0.00~200.00
4CH	200V	0.00~200.00

Pressing the RANGE function key allows the display unit to show the present measuring range for every channel.

The cursor blinks at the CH1 setting display, indicating that the CH1 measuring range can be changed.



1CH	<u>5V</u>	<u>0.000~5.000</u>
2CH	200V	0.00~200.00
3CH	200V	0.00~200.00
4CH	200V	0.00~200.00

Turning the setting knob transfers the CH1 measuring range contents shown in Table 6.2 in the order of DC voltage, thermocouple and RTD successively.

Select any range.

Lighting up of the LED at the top right of the setting knob indicates that setting knob operation is valid. Further, the pen moves corresponding to range change.



1CH	5V	0.000~5.000
2CH	<u>200V</u>	<u>0.00~200.00</u>
3CH	200V	0.00~200.00
4CH	200V	0.00~200.00

Then, press the cursor key below the setting knob to shift the cursor to the next channel. This allows you to set the measuring range to the next channel.

or



1CH	5V	0.000~5.000
2CH	<u>T</u>	<u>-200.0~400.0</u>
3CH	50mV	0.00~50.00
4CH	<u>10V</u>	<u>0.000~10.000</u>

After the final channel measuring range has been set, press the ENTRY key twice. This enables the display to return to the original status.

Table 6.2 Standard Mode Range and Span Table

DC Voltage range		SPAN	
High Sensitivity	Medium Sensitivity	100 $\mu$ V	0 to 100 $\mu$ V
		200 $\mu$ V	0 to 200 $\mu$ V
		500 $\mu$ V	0 to 500 $\mu$ V
	Low Sensitivity	1 mV	0 to 1 mV
		2 mV	0 to 2 mV
		5 mV	0 to 5 mV
		10 mV	0 to 10 mV
		20 mV	0 to 20 mV
		50 mV	0 to 50 mV
		100 mV	0 to 100 mV
		200 mV	0 to 200 mV
		500 mV	0 to 500 mV
		1 V	0 to 1 V
		2 V	0 to 2 V
		5 V	0 to 5 V
10 V	0 to 10 V		
20 V	0 to 20 V		
50 V	0 to 50 V		
100 V	0 to 100 V		
200 V	0 to 200 V		

Temperature range	SPAN			
	$^{\circ}$ C	$^{\circ}$ F		
TC	R	0.0 to 1700.0 $^{\circ}$ C	100 to 3200 $^{\circ}$ F	
	S	0.0 to 1700.0 $^{\circ}$ C	100 to 3200 $^{\circ}$ F	
	B	0.0 to 1800.0 $^{\circ}$ C	100 to 3300 $^{\circ}$ F	
	K	-200.0 to 1300.0 $^{\circ}$ C	-300.0 to 2400.0 $^{\circ}$ F	
		-200.0 to 800.0 $^{\circ}$ C	-300.0 to 1400.0 $^{\circ}$ F	
	J	-200.0 to 1100.0 $^{\circ}$ C	-300.0 to 2000.0 $^{\circ}$ F	
	T	-200.0 to 400.0 $^{\circ}$ C	-300.0 to 700.0 $^{\circ}$ F	
	N	0.0 to 1300.0 $^{\circ}$ C	100.0 to 2300.0 $^{\circ}$ F	
		0.0 to 2300.0 $^{\circ}$ C	100 to 4100 $^{\circ}$ F	
	L (J DIN)	-200.0 to 900.0 $^{\circ}$ C	-300.0 to 1600.0 $^{\circ}$ F	
	U (T DIN)	-200.0 to 400.0 $^{\circ}$ C	-300.0 to 700.0 $^{\circ}$ F	
	Kp VS Ap7Fe	0.0 to 300.0 K	0.0 to 300.0 K	
	RTD	Pt 100 : 1	-200.0 to 800.0 $^{\circ}$ C	-300.0 to 1500.0 $^{\circ}$ F
		Pt 100 : 2	-200.0 to 400.0 $^{\circ}$ C	-300.0 to 700.0 $^{\circ}$ F
		Pt 100 : 3	-100.0 to 100.0 $^{\circ}$ C	-200.0 to 300.0 $^{\circ}$ F
Pt 50 : 1		-200.0 to 600.0 $^{\circ}$ C	-300.0 to 1100.0 $^{\circ}$ F	
Pt 50 : 2		0.0 to 600.0 $^{\circ}$ C	0.0 to 1100.0 $^{\circ}$ F	
Pt 100 : 1 / JPt		-200.0 to 600.0 $^{\circ}$ C	-300.0 to 1100.0 $^{\circ}$ F	
Pt 100 : 2 / JPt		-200.0 to 400.0 $^{\circ}$ C	-300.0 to 700.0 $^{\circ}$ F	
Pt 100 : 3 / JPt		-100.0 to 100.0 $^{\circ}$ C	-200.0 to 300.0 $^{\circ}$ F	
Pt 50 : 1		-200.0 to 600.0 $^{\circ}$ C	-300.0 to 1100.0 $^{\circ}$ F	
Pt 50 : 2		0.0 to 600.0 $^{\circ}$ C	0.0 to 1100.0 $^{\circ}$ F	
Ni100 (DIN)		0.0 to 100.0 $^{\circ}$ C	0.0 to 300.0 $^{\circ}$ F	
Ni100 (SAMA)		-200.0 to 200.0 $^{\circ}$ C	-300.0 to 400.0 $^{\circ}$ F	

(2) Program Mode

Function :

Allows the recorder to set application modes other than the standard mode per channel to the program as shown in the tables below.

Seven settings are available in the standard function. For details, see the succeeding pages.

<p><b>[OFF]</b></p> <p>4CH MODE : OFF</p>	<p><b>[VOLT]</b></p> <p>4CH MODE : VOLT RANGE : 5V SPAN L : 0.000V SPAN R : 5.000V FILTER : OFF</p>	<p><b>[TC]</b></p> <p>4CH MODE : TC TYPE : S SPAN L : 0.0 °C SPAN R : 1760.0 °C FILTER : OFF</p>
<p><b>[RTD]</b></p> <p>4CH MODE : RTD TYPE : Pt100:1 SPAN L : 0.0 °C SPAN R : 100.0 °C FILTER : OFF</p>	<p><b>[DELTA]</b></p> <p>4CH MODE : DELT REF CH : 1CH SPAN L : 0.000mV SPAN R : 5.000mV FILTER : 1Hz</p>	<p><b>[SCALE]</b></p> <p>4CH MODE : SCALE/VOLT RANGE : 200V TYPE:(IN CASE OF SCALE/TC) SPAN L : 0.00V SPAN R : 200.00V SCALE L : 1% SCALE R : 100% UNIT : % FILTER : 0.1Hz</p>
<p><b>[COPY]</b></p> <p>4CH MODE : COPY CH:1CH</p>		

(Note) For the one-pen type, the upper most CH setting input is not provided.



[OFF]

**Function** : Turns channels not used for measuring OFF.

**Setting Item** : ① Channel Selection  
 ② Channel OFF

**Setting Example** : Setting CH4 to OFF

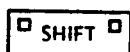
[Key operation]

RANGE

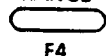

F4

[Setting display]

```

1CH
MODE : VOLT
RANGE : 5V
SPAN L : 0.000V
SPAN R : 5.000V
FILTER : OFF
1CH 2CH 3CH 4CH
  
```

[Description]

Press the RANGE function key after the SHIFT key to enable the setting display to appear. The display unit always shows the present CH1 setting display. Press the F4 key to select CH4.

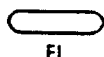

F1

```

4CH
MODE : VOLT
RANGE : 5V
SPAN L : 0.000V
SPAN R : 5.000V
FILTER : OFF
↓ OFF VOLT TC RTD
  
```

The display unit shows the present CH4 setting contents. Press the F1 key to set the channel OFF mode.



ENTRY



ENTRY

```

4CH
MODE : OFF
↓ OFF VOLT TC RTD
  
```

The OFF mode appears. After confirming it, press the ENTRY key. This validates the setting contents.

To complete the setting, press the ENTRY key once more. This enables the display to return to the original status.

**Note** : If the range is set OFF, alarms set so far will be released automatically. Apart from alarms, Auto Span Shift (and partial contraction / expansion mode) is also released automatically.

[VOLT]

**Function** : Setting to measure VOLT (voltage).

**Setting Item** :

- ① CH : Channel No.
- ② RANGE : Measuring range
- ③ SPAN L : Span (measuring range) left value
- ④ SPAN R : Span (measuring range) right value
- ⑤ FILTER : Low-pass-filter frequency

**Setting Example** :

- ① CH : 4CH
- MODE : VOLT
- ② RANGE : 5V
- ③ SPAN L : 1.000 V
- ④ SPAN R : 5.000 V
- ⑤ FILTER : 1 HZ

[Key operation]

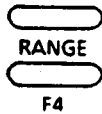
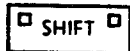

[Setting display]

```

1CH
MODE : VOLT
RANGE : 5V
SPAN L : 0.000V
SPAN R : 5.000V
FILTER : OFF
1CH 2CH 3CH 4CH
    
```

[Description]

Press the function key "RANGE" after the SHIFT key to show enable the setting display panel. The display panel always shows the setting display panel corresponding to the present CH1. Press the F4 key to select CH4.

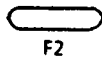

```

4CH
MODE : OFF

↓ OFF VOLT TC RTD
↓ DELT SCAL COPY
    
```

When the channel is selected, the cursor shifts automatically to MODE. Press the F2 key to set MODE to VOLT.



**[Key operation]****[Setting display]**

```

4CH
MODE : VOLT
RANGE : 2V
SPAN L : 0.0000V
SPAN R : 2.0000V
FILTER : OFF

```

**[Description]**

Select the range (5 V) using the setting knob.  
After range selection, press the cursor key to move to the next setting.

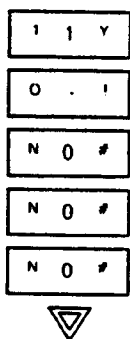

```

4CH
MODE : VOLT
RANGE : 5V
SPAN L : 0.000V
SPAN R : 5.000V
FILTER : OFF
← → del

```

Set SPAN L using the ten key. The span setting range is as shown in Table 6.2. The number of digits is changed by entering numerics or by pressing the F1 (←) or F2 (→) keys. Unnecessary numerics can be deleted by pressing the F3 (del) key. After the setting ends, press the cursor key. When no numeric change is required, press the cursor key to move to the next setting.

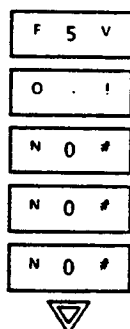

```

4CH
MODE : VOLT
RANGE : 5V
SPAN L : 1.000V
SPAN R : 5.000V
FILTER : OFF
← → del

```

Set the right span (SPAN R) using the ten key. The setting procedure is the same as for the left span. After setting is finished, press the cursor key.

[Key operation]

[Setting display]

[Description]

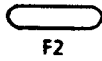

4CH  
 MODE : VOLT  
 RANGE : 5V  
 SPAN L : 1.000V  
 SPAN R : 5.000V  
 FILTER : OFF  
 0.1 1Hz OFF

Set the low pass filter frequency to 1Hz by pressing the F2 key.



4CH  
 MODE : VOLT  
 RANGE : 5V  
 SPAN L : 1.000V  
 SPAN R : 5.000V  
 FILTER : 1Hz  
 0.1 1Hz OFF

Press the Entry key. The details set at this time are used for the measurement, and the cursor returns to the CH position. Continue program setting as required, and when it is necessary to end the setting, press the ENTRY key to return the display to the original display.

Table 6.2 Span setting range

Input range		Setting range			
High Sensitivity	Medium Sensitivity	100 $\mu$ V	- 110.00 to 110.00 $\mu$ V		
		200 $\mu$ V	- 220.00 to 220.00 $\mu$ V		
		500 $\mu$ V	- 550.0 to 550.0 $\mu$ V		
	Low Sensitivity	Medium Sensitivity	1 mV	- 1.1000 to 1.1000 mV	
			2 mV	- 2.2000 to 2.2000 mV	
			5 mV	- 5.500 to 5.500 mV	
		Low Sensitivity	Low Sensitivity	10 mV	- 11.000 to 11.000 mV
				20 mV	- 22.000 to 22.000 mV
				50 mV	- 55.00 to 55.00 mV
				100 mV	- 110.00 to 110.00 mV
				200 mV	- 220.00 to 220.00 mV
				500 mV	- 550.0 to 550.0 mV
				1 V	- 1.1000 to 1.1000 V
				2 V	- 2.2000 to 2.200 V
				5 V	- 5.500 to 5.500 V

\* Exceeding the setting range causes overrange

[TC]

**Function** : Setting to perform measurement by TC

**Setting Item** :

- ① CH : Channel No.
- ② Type : Thermocouple type
- ③ SPAN L : Span (measuring range) left value
- ④ SPAN R : Span (measuring range) right value
- ⑤ FILTER : Low-pass-filter frequency

**Setting Example** :

- ① CH : 4CH
- ② TYPE : T
- ③ SPAN L : 100 °C
- ④ SPAN R : 300 °C
- ⑤ FILTER : OFF

[Key operation]

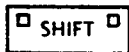

RANGE

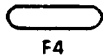

F4

[Setting display]

```

1CH
MODE : VOLT
RANGE : 5V
SPAN L : 0.000V
SPAN R : 5.000V
FILTER : OFF
1CH 2CH 3CH 4CH

```

[Description]

Press the function key "RANGE" after the SHIFT key to show the setting display panel. The display panel always shows the setting display panel corresponding to the present (No.1) CH.

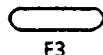

F3

```

4CH
MODE : OFF
↓ OFF VOLT TC RTD
↓ DELT SCAL COPY

```

Press the F4 key to select CH4. When the channel is selected, the cursor shifts automatically to MODE. Press the F3 key to set MODE to TC.

[Key operation]

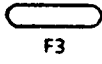
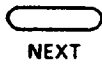

or

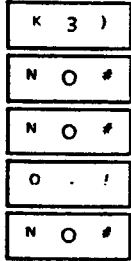
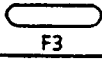
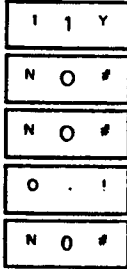
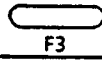

[Setting display]

```

4CH
MODE : TC
TYPE : S
SPAN L : 0.0 °C
SPAN R : 1760.0 °C
FILTER : 1Hz
↓ R S B K
↓ E J T N
↓ W L U Kpvs
    
```

```

4CH
MODE : TC
TYPE : T
SPAN L : -200.0 °C
SPAN R : 400.0 °C
FILTER : 1Hz
← → del
    
```

```

4CH
MODE : TC
TYPE : T
SPAN L : 100.0 °C
SPAN R : 400.0 °C
FILTER : 1Hz
← → del
    
```

[Description]

Set thermocouples (type 'T') by pressing the NEXT and F3 keys or by turning the setting knob. After the setting ends, press the cursor key.

Set SPAN L (100.0°C) by pressing the numeric keypad. The span setting range is as shown in Table 6.3. Press the cursor key.

Set SPAN R (300.0) by pressing the numeric keypad, then press the cursor key.

[Key operation]

[Setting display]

[Description]



  
F3

```

4CH
MODE : TC
TYPE : T
SPAN L : 100.0 °C
SPAN R : 300.0 °C
FILTER : 1Hz
0.1 1Hz OFF

```

Press the F3 key to turn OFF the filter. Press the ENTRY key.

```

4CH
MODE : TC
TYPE : T
SPAN L : 100.0 °C
SPAN R : 300.0 °C
FILTER : OFF

```

The details set at this time are used for the measurement and the cursor returns to the CH position.

Continue program settings as required, then when it is necessary to end the setting, press the ENTRY key.

Table 6.3 Span Setting Range

Input Range	°C	°F
R	0.0 to 1760.0	32 to 3200
S	0.0 to 1760.0	32 to 3200
B	0.0 to 1820.0	32 to 3308
K	-200.0 to 1370.0	-328.0 to 2498.0
E	-200.0 to 800.0	-328.0 to 1472.0
J	-200.0 to 1100.0	-328.0 to 2012.0
T	-200.0 to 400.0	-328.0 to 752.0
N	0.0 to 1300.0	32.0 to 2372.0
C (W)	0.0 to 2315.0	32 to 4199
L (J DIN)	-200.0 to 900.0	-328.0 to 1652.0
U (T DIN)	-200.0 to 400.0	-328.0 to 752.0
Kp vs Au7Fe	0.0 to 300.0K	0.0 to 300.0K

[RTD]

**Function** : Setting to perform measurement by RTD

- Setting Item** :
- ① CH : Channel No.
  - ② Type : RTD type
  - ③ SPAN L : Span (measuring range) left value
  - ④ SPAN R : Span (measuring range) right value
  - ⑤ FILTER : Low-pass-filter frequency

- Setting Example** :
- ① CH : 4CH
  - ② TYPE : Pt100 : 1 / JPt
  - ③ SPAN L : 0.0°C
  - ④ SPAN R : 50.0°C
  - ⑤ FILTER : 1Hz

[Key operation]

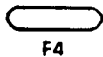
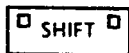

[Setting display]

```

1CH
MODE : VOLT
RANGE : 5V
SPAN L : 0.000V
SPAN R : 5.000V
FILTER : OFF
1CH 2CH 3CH 4CH
    
```

[Description]

Press the function key "RANGE" after the SHIFT key to show the setting display panel, which always displays the setting display panel corresponding to the present CH1.

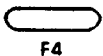

```

4CH
MODE : OFF

↓ OFF  VOLT  TC  RTD
↓ DELT SCAL COPY
    
```

Press the F4 key to select CH No.4.

When the channel is selected, the cursor shifts automatically to MODE. Press the F4 key to set MODE to RTD.

**[Key operation]**

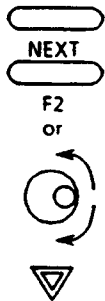

**[Setting display]**

```

4CH
MODE : RTD
TYPE : Pt100:1/JPt
SPAN L : -200.0 °C
SPAN R : 600.0 °C
FILTER : OFF
↓ Pt1 Pt2 Pt3 Pt4
↓ Pt5 Pt1J Pt2J Pt3J
↓ Pt4J Pt5J Ni1D Ni1S
↓ J263
    
```

**[Description]**

Selecting the RTD type (Pt 100 : 1/JPt)

The type can be selected by pressing the F1 to F4 keys or by turning the setting knob. Refer to table 6.4 for the relationship between RTD types, and their abbreviations.

After setting is finished, press the cursor key. (When the F1 to F4 keys are pressed, the cursor shifts automatically.)

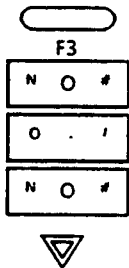

```

4CH
MODE : RTD
TYPE : Pt100:1/JPt
SPAN L : -200.0 °C
SPAN R : 600.0 °C
FILTER : OFF
← → del
    
```

Set SPAN L (0.0°C) by pressing the numeric keypad.

The span setting range is as shown in Table 6.4 Press the cursor key.

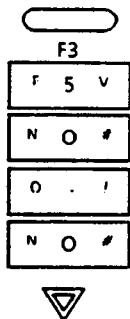

```

4CH
MODE : RTD
TYPE : Pt100:1/JPt
SPAN L : 0.0 °C
SPAN R : 600.0 °C
FILTER : OFF
← → del
    
```

Set SPAN R (50.0°C) by pressing the numeric keypad, then press the cursor key.

[Key operation]

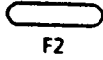

[Setting display]

```

4CH
MODE : RTD
TYPE : Pt100:1/JPt
SPAN L : 0.0 °C
SPAN R : 50.0 °C
FILTER : OFF.
0.1 1Hz OFF
    
```

[Description]

Press the F2 key to set the filter to 1 Hz.



```

4CH
MODE : RTD
TYPE : Pt100:1/JPt
SPAN L : 0.0 °C
SPAN R : 50.0 °C
FILTER : 1Hz
    
```

Press the ENTRY key. The details set at this time are used for the measurement and the cursor returns to the CH position.

Change the other CH setting when required, and when it is necessary to end the setting, press the ENTRY key.

Table 6.4 RTD Range

Menu Display	Display	Measuring Range	
		°C	°F
Pt1	Pt100: 1	- 200.0 to 850.0	- 328.0 to 1562.0
Pt2	Pt100: 2	- 200.0 to 400.0	- 328.0 to 752.0
Pt3	Pt100: 3	- 150.0 to 150.0	- 238.0 to 302.0
Pt4	Pt50 : 1	- 200.0 to 640.0	- 328.0 to 1184.0
Pt5	Pt50 : 2	- 50.0 to 600.0	- 58.0 to 1112.0
Pt1J	Pt100: 1/JPt	- 200.0 to 640.0	- 328.0 to 1184.0
Pt2J	Pt100: 2/JPt	- 200.0 to 400.0	- 328.0 to 752.0
Pt3J	Pt100: 3/JPt	- 150.0 to 150.0	- 328.0 to 302.0
Pt4J	Pt50 : 1/JPt	- 200.0 to 640.0	- 328.0 to 1184.0
Pt5J	Pt50 : 2/JPt	- 50.0 to 600.0	- 58.0 to 1112.0
Ni1D	Ni100/DIN	- 60.0 to 180.0	- 76.0 to 356.0
Ni1S	Ni100/SAMA	- 200.0 to 250.0	- 328.0 to 482.0



**[DELTA]**

- Function** : Calculates the differential from the other channel (CH).
- Setting Item** :
- ① CH : Which undergoes differential calculation
  - ② REF CH : Reference channel
  - ③ SPAN L : Span (measuring range) left value
  - ④ SPAN R : Span (measuring range) right value
  - ⑤ FILTER : Low-pass-filter frequency
- Restrictions** :
- ① The CH No. which undergoes differential calculation must be higher than the reference CH No.  
Therefore if CH1 is specified to the CH which undergoes differential calculation, DELTA mode cannot be selected.
  - ② The CH No. which undergoes differential calculation and the reference CH RANGE (voltage) or TYPE (temperature) must be the same.
  - ③ If the CH No. which undergoes differential calculation, or the reference CH MODE, RANGE or TYPE is changed, the DELTA mode is released automatically.
  - ④ The differential calculation cannot be set when MODE is other than VOLT, TC and RTD.
  - ⑤ For the one-pen model, DELTA mode cannot be selected.
- Setting Example** :
- ① CH : 4CH
  - ② REF CH : 2CH (TC, TYPE T)
  - ③ SPAN L : -50.0°C
  - ④ SPAN R : 50.0°C
  - ⑤ FILTER : 1Hz

[Key operation]

[Setting display]

[Description]

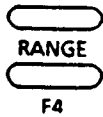

```

1CH
MODE : VOLT
RANGE : 5V
SPAN L : 0.000V
SPAN R : 5.000V
FILTER : OFF
1CH 2CH 3CH 4CH
    
```

Press the function key "RANGE" after the SHIFT key to show the setting display panel. The display panel always shows the setting display panel corresponding to the present CH1.

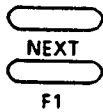

```

4CH
MODE : OFF
↓ OFF VOLT TC RTD
↓ DELT SCAL COPY
    
```

If the channel is selected, the cursor shifts to MODE automatically. Press the NEXT and F1 keys to set MODE to DELTA.

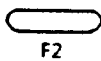

```

4CH
MODE : DELTA
REF CH : 1CH
SPAN L : -200.0 °C
SPAN R : 400.0 °C
FILTER : OFF
1CH 2CH 3CH 4CH
    
```

Set the reference CH (CH2).

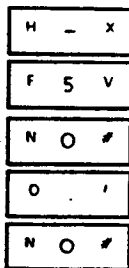

```

4CH
MODE : DELTA
REF CH : 2CH
SPAN L : -200.0 °C
SPAN R : 400.0 °C
FILTER : OFF
← → del
    
```

Set SPAN L (-50.0°C) by pressing the numeric keypad. The span that can be set is as shown in Table 6.5. After completing setting, press the cursor key.

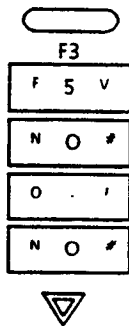

```

4CH
MODE : DELTA
REF CH : 2CH
SPAN L : -50.0 °C
SPAN R : 400.0 °C
FILTER : OFF
← → del
  
```

Set SPAN R (50.0°C)

The decimal point position is corrected automatically during ENTRY by pressing the cursor key.

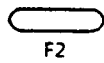

```

4CH
MODE : DELTA
TYPE : 2CH
SPA L : -50.0 °C
SPA R : 50.0 °C
FILTER : OFF
0.1 1Hz OFF
  
```

Press the F2 key to set the filter frequency to 1 Hz.

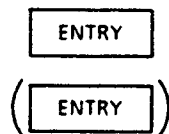

```

4CH
MODE : DELTA
REF CH : 2CH
SPAN L : -50.0 °C
SPAN R : 50.0 °C
FILTER : 1Hz
  
```

Press the ENTRY key.

The details set at this time are used for the measurement, and as a result the cursor returns to the CH1 position. When completing the setting, press the ENTRY key again.

## (1) Thermocouple

Table 6.5 DELTA Mode Setting Range

	°C	°F
	Range	Range
R	-1760.0 to 1760.0	-3200 to 3200
S	-1760.0 to 1760.0	-3200 to 3200
B	-1820.0 to 1820.0	-3295 to 3295
K	-1370.0 to 1370.0	-2498.0 to 2498.0
E	-800.0 to 800.0	-1472.0 to 1472.0
J	-1100.0 to 1100.0	-2012.0 to 2012.0
T	-400.0 to 400.0	-752.0 to 752.0
N	-1300.0 to 1300.0	-2372.0 to 2372.0
C (W)	-2315.0 to 2315.0	-4199 to 4199
L (J DIN)	-900.0 to 900.0	-1562.0 to 1562.0
U (T DIN)	-400.0 to 400.0	-752.0 to 752.0
Kp vs Au 7Fe	-300.0 to 300.0K	-300.0 to 300.0K

## (2) Resistance Temperature Detector

	°C	°F
	Range	Range
Pt100 : 1	-850.0 to 850.0	-1562.0 to 1562.0
Pt100 : 2	-400.0 to 400.0	-752.0 to 752.0
Pt100 : 3	-150.0 to 150.0	-302.0 to 302.0
Pt50 : 1	-640.0 to 640.0	-1184.0 to 1184.0
Pt50 : 2	-600.0 to 600.0	-1112.0 to 1112.0
Pt100 : 1/JPt	-640.0 to 640.0	-1184.0 to 1184.0
Pt100 : 2/JPt	-400.0 to 400.0	-752.0 to 752.0
Pt100 : 3/JPt	-150.0 to 150.0	-302.0 to 302.0
Pt50 : 1	-640.0 to 640.0	-1184.0 to 1184.0
Pt50 : 2	-600.0 to 600.0	-1112.0 to 1112.0
Ni100 /DIN	-180.0 to 180.0	-356.0 to 356.0
Ni100/SAMA	-250.0 to 250.0	-482.0 to 482.0

## (3) Voltage

Range
+ 110% of each range
Example : In 10mV range
-11.000 to 11.000 mV

**[SCALE]**

**Function** : Converts voltage outputs from various converters to the respective physical amounts, along with performing temperature range scaling.

**Setting Item** :

- ① CH : Channel No.
- ② RANGE : Input type or TYPE
- ③ SPAN L : Span (measuring range) left value
- ④ SPAN R : Span (measuring range) right value
- ⑤ SCALE L : Scaling span left value
- ⑥ SCALE R : Scaling span right value
- ⑦ UNIT : Engineering unit (Up to 6 characters)
- ⑧ FILTER : Low - pass - filter frequency

**Setting Example** :

- ① CH : 4CH
- ② RANGE : 5 V
- ③ SPAN L : 1.000 V
- ④ SPAN R : 5.000 V
- ⑤ SCALE L : 0.00
- ⑥ SCALE R : 100.00
- ⑦ UNIT : %
- ⑧ FILTER : 1 Hz

[Key operation]

[Setting display]

[Description]

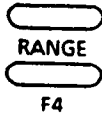

```

1CH
MODE : VOLT
RANGE : 5V
SPAN L : 0.000V
SPAN R : 5.000V
FILTER : OFF
1CH 2CH 3CH 4CH
    
```

Press the function key "RANGE" after the SHIFT key to show the setting display panel. The display panel always shows the setting display panel corresponding to the present CH1. Press the F4 key to select CH4.

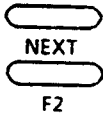

```

4CH
MODE : OFF
↓ OFF VOLT TC RTD
↓ DELT SCAL COPY
    
```

When the channel is selected, the cursor shifts automatically to MODE. Press the NEXT and F2 keys to set MODE to SCALE.

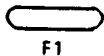

```

4CH
MODE : SCALE/VOLT
RANGE : 2V
SPAN L : 0.0000V
SPAN R : 2.0000V
SCALE L : 1.000ABC
SCALER : 10.000ABC
UNIT : ABC
FILTER : OFF
VOLT TC RTD COM
    
```

Press the F1 key to set SCALE MODE to VOLT (voltage). VOLT, TC (thermocouple), RTD (resistance temperature detector) and optional COM (communication) are available as SCALE MODES.



```

4CH
MODE : SCALE/VOLT
RANGE : 2V
SPAN L : 0.0000V
SPAN R : 2.0000V
SCALE L : 1.000ABC
SCALE R : 10.000ABC
UNIT : ABC
FILTER : OFF
    
```

Select RANGE (5 V) by turning the setting knob, and after setting is finished, press the cursor key.

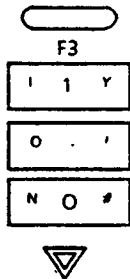
**[Key operation]****[Setting display]**

```

4CH
MODE : SCALE/VOLT
RANGE : 5V
SPAN L : 0.000V
SPAN R : 5.000V
SCALE L : 1.000ABC
SPALE R : 10.000ABC
UNIT : ABC
FILTER : OFF

```

← → del meas

**[Description]**

Enter SPAN L (1.000 V), then press the cursor key.

The decimal point position is corrected automatically during ENTRY.

The application of meas, which is displayed on the menu at this time, is explained at the end of [SCALE].

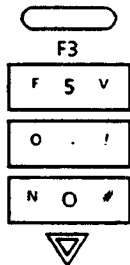

```

4CH
MODE : SCALE/VOLT
RANGE : 5V
SPAN L : 1.000V
SPAN R : 5.000V
SCALE L : 1.000ABC
SPALE R : 10.000ABC
UNIT : ABC
FILTER : OFF

```

← → del meas

Enter SPAN R (5.000 V) then, press the cursor key.

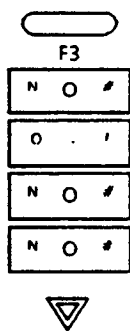

```

4CH
MODE : SCALE/VOLT
RANGE : 5V
SPAN L : 1.000V
SPAN R : 5.000V
SCALE L : 1.000ABC
SPALE R : 10.000ABC
UNIT : ABC
FILTER : OFF

```

← → del

Set SCALE L (0.00), then press the cursor key.

[Key operation]

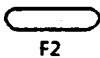
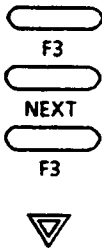
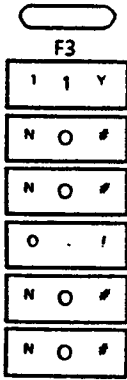

[Setting display]

```

4CH
MODE : SCALE/VOLT
RANGE : 5V
SPAN L : 1.000V
SPAN R : 5.000V
SCALE L : 0.00ABC
SCALE R : 100.00ABC
UNIT : ABC
FILTER : OFF
← → del
    
```

```

4CH
MODE : SCALE/VOLT
RANGE : 5V
SPAN L : 1.000V
SPAN R : 5.000V
SCALE L : 0.00ABC
SCALE R : 100.00ABC
UNIT : ABC
FILTER : OFF
↓ ← → del
↓ Ω μ % &
    
```

```

4CH
MODE : SCALE/VOLT
RANGE : 5V
SPAN L : 1.000V
SPAN R : 5.000V
SCALE L : 0.00%
SCALE R : 100.00%
UNIT : %
FILTER : OFF
0.1 1Hz OFF
    
```

[Description]

Set SCALE R (100.00), then press the cursor key.

Set UNIT to %. Delete the present contents by pressing the F3 key, press the NEXT and F3 keys in this order, then press the cursor key.

Set characters other than those on the menu by pressing the ALPHANUMERIC key. Up to 6 characters can be entered, but SCALE is displayed in 5 characters. In addition, data is displayed in 2 characters from the head.

Press the F2 key to set the filter frequency to 1Hz.



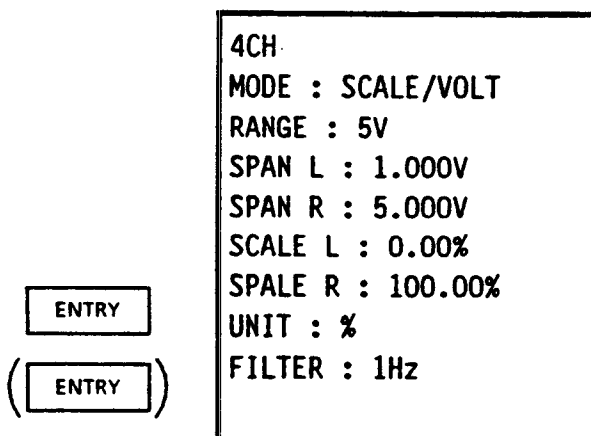

Press the ENTRY key.

The details set at this time are used for the measurement, and the cursor returns to the CH position. Continue program setting as required, and when it is necessary to end the setting, press the ENTRY key to return the display to the original display.

**Notes :**

1. When the scale L decimal point position differs from that of SCALE R, match this position with the smaller number of digits after the decimal point.
2. When SPAN is set from 1 to 5 V and SCALE from 0 to 10 kg, outputs are as follows for an input of 1.2 V.

SCALE	0 to 10kg	0.0 to 10.0kg	0.00 to 10.00kg
	↓	↓	↓
Output	0 kg	0.5 kg	0.50 g

3. When the input exceeds SPAN L and SPAN R, the overflow display appears.
4. For the displayed value, the digits below the effective display digits are discarded. When the right and left value width of the scale value is large (e.g. scale value is - 2.0000 and when the decimal point is rejected the scale width is 40000 and this is larger than 32767), the maximum of two digit error may cause in the displayed value.

**(Meas. Function)**

This recorder converter output voltages at ZERO and FULL can be set directly as span left and right values during VOLT range span setting.

Thus, slight converter errors are corrected automatically.

(Example) When the physical amount of 0 to 10 kg is converted by the converter and the converted result is recorded on the RD3721/RD3722.

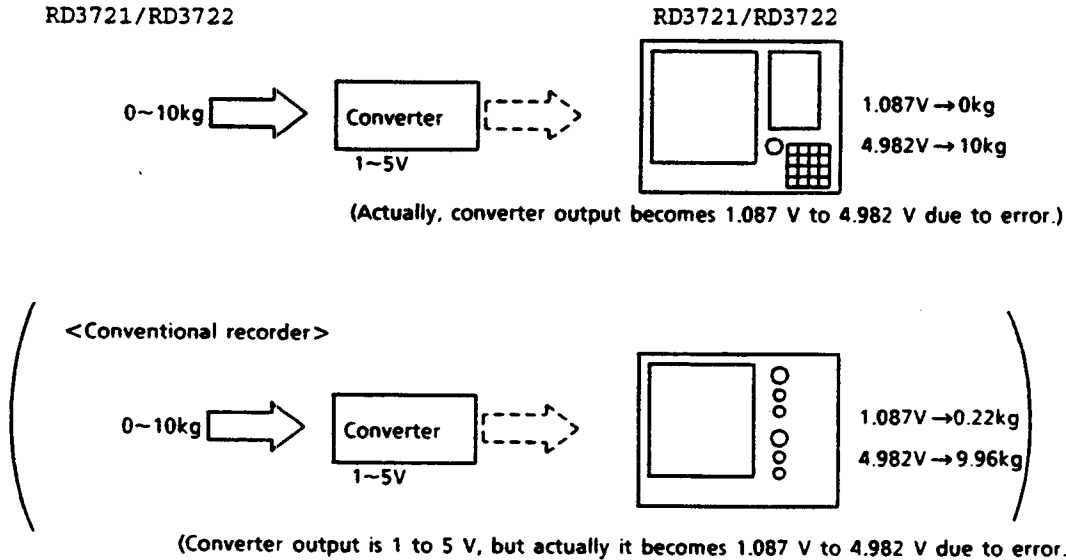

The RD3721/RD3722 reads converted signals as the actual measured values which are displayed digitally and printed out.

0kg→(1.087V), 10kg(→4.982V)

Thus, even if there is a slight error in converter output, the RD3721/RD3722 maintains accuracy measured values without needing to recalibrate the converter as long as linearity is maintained between converter input and output.

**meas. Function Setting**

Pressing the F4 key (meas.) during span setting can substitute the actual measured-value for the SPAN value.

**[Key operation]**

**[Setting display]**

**[Description]**

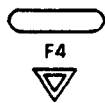

```

4CH
MODE : SCALE/VOLT
RANGE : 5V
SPAN L : 0.000V
SPAN R : 5.000V
SCALE L :
SCALE R :
UNIT :
FILTER :
← → del meas
    
```

Conduct this setting with the input connected. Assume that the actual measured-value correspond to SPAN L 1.010 V and SPAN R 4.990 V. Press the F4 key (meas) in the SPAN L item, then press the cursor key.

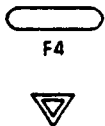

```

4CH
MODE : SCALE/VOLT
RANGE : 5V
SPAN L : 1.010V
SPAN R : 5.000V
SCALE L :
SCALE R :
UNIT :
FILTER :
← → del meas
    
```

The measured value 1.010V is assigned.

Press the F4 key in the item of SPAN R, then press the cursor key.

```

4CH
MODE : SCALE/VOLT
RANGE : 5V
SPAN L : 1.010V
SPAN R : 4.990V
SCALE L :
SCALE R :
UNIT :
FILTER :
    
```

The measured value 4.990 V is assigned. The other setting is the same as the SCALE setting already described.

[COPY]

**Function :** Setting in which the contents of the settings mode to the other CH are used without modification.  
For the one - pen model, COPY function is not provided.

**Setting Item :** ① CH : Channel No.  
② Copy CH : Other channel No. to be copied.

**Setting Example :** ① CH : 4CH  
② Copy CH : 2CH

[Key operation]



[Setting display]

```

1CH
MODE : VOLT
RANGE : 5V
SPAN L : 0.000V
SPAN R : 5.000V
FILTER : OFF
      1CH 2CH 3CH 4CH
    
```

[Description]

Press the RANGE function key after the SHIFT key to enable the setting display to appear. The display unit always shows the present CH1 setting display. Press the F4 key to select CH4.



F3

```

4CH
MODE : OFF
      ↓ OFF  VOLT  TC  RTD
      ↓ DELT SCAL COPY
    
```

When a channel is selected, the cursor moves to MODE automatically. Press the NEXT and F3 keys to set MODE to COPY.

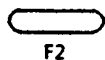
**[Key operation]****[Setting display]****[Description]**

F2

4CH  
 MODE : COPY CH : CH

1CH 2CH 3CH 4CH

Select the CH (CH2) to be copied by pressing the F2 key. Thus, the contents of the CH2 are copied to CH4.

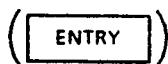

4CH  
 MODE : VOLT  
 RANGE : 5V  
 SPAN L : -5.000V  
 SPAN R : 5.000V  
 FILTER : OFF

Press the ENTRY key. The details set at this time are used for the measurement, and the cursor returns to the CH position. Continue program setting if required, and when it is necessary to end the setting, press the ENTRY key to return the display to the original display.

### 6.4.3 ZERO Adjustment

#### Function

Adjustment of zero position and pen position parallel movement can be made independently according to the RECORD ON/OFF switch (Ⓞ in Section 3.1) status of each pen.

① RECORD OFF status  
Pressing ◀ZERO▶ moves the pen to the zero position and as a result, any zero position can be set by turning the setting knob in the same way as with conventional analog pen recorders.

② RECORD ON status  
Pressing ◀ZERO▶ enables the data to be moved (pen position) during measurement by turning the setting knob (SPAN also moves in parallel.)

#### [Key operation]



#### [Setting display]

1CH	0.000 ~ 5.000V
2CH	0.00 ~ 200.00V
3CH	0.00 ~ 200.00V
4CH	0.00 ~ 200.00V

#### [Description]

Press the ◀ZERO▶ function key.

All the pens set to the DC voltage range and RECORD OFF move to their zero positions and the display panel simultaneously shows the measuring range of each channel.

The cursor flashes at the first channel position.

\* Ranges other than DC voltage (VOLT) ranges are displayed as "Cannot be set", and the channel RECORD on continues to record the data

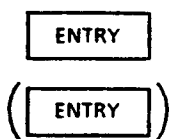

1CH	0.000 ~ 5.000V
2CH	0.00 ~ 200.00V
3CH	0.00 ~ 200.00V
4CH	0.00 ~ 200.00V

Select the channel to be zero-adjusted by the cursor.

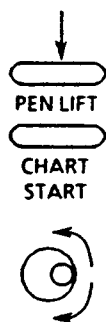

Lower the pen by pressing the PEN LIFT key, then press the CHART START key to feed the chart.

Match the ZERO point to the main division on the chart by turning the setting knob while drawing a line with the pen.

When ZERO adjustment of each channel ends, press the ENTRY key twice, and the display returns to the original display panel.

**Note :** For ZERO and SPAN adjustments and VOLT measurement.

If the SPAN LEFT or RIGHT value exceeds the present input measuring range (refer to Table 6.2 and for the 5 V range : +5.5 V), the suitable internal range is selected automatically.

If the SPAN is narrow and both ends of SPAN LEFT and RIGHT enter the present lower (high-sensitivity side) reference range (for 5 V range : + 5 V), the internal lower range is selected automatically.

#### 6.4.4 SPAN Adjustment

**Function**

: Adjust SPAN (measuring range) by turning the setting knob. When the input changes suddenly during recording, SPAN can be changed immediately by using this mode without showing the range setting SPAN display panel.

**Setting Item**

- : ① CH : Channel No.  
 ② L : SPAN left value adjustment  
 ③ R : SPAN right value adjustment  
 ④ L&R : Adjustment of SPAN L and R.  
 ⑤ srch : Searches the low range for the measuring range and sets a range which does not overflow so that SPAN automatically, becomes +110% of range.

**Setting Example :** Search the span of CH4 then change the range to -550 to 450 mV after selecting -550 to 550 mV.

**Restrictions**

- : ① SPAN can be adjusted only when MODE is set to VOLT, TC or RTD and COM (optional).  
 ("Can not be set" is displayed in modes other than the above.)  
 ② Only the voltage range can be searched.

[Key operation]

[Setting display]

[Description]

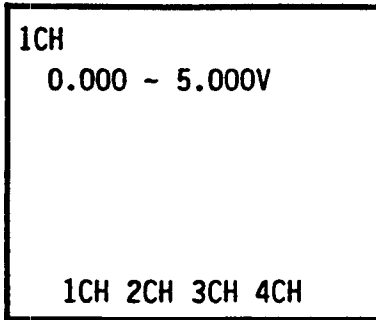
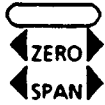

Press the SPAN key after the SHIFT key to enable the setting display to appear. The display unit always shows the present CH1 setting display. Press the F4 key to select CH4.

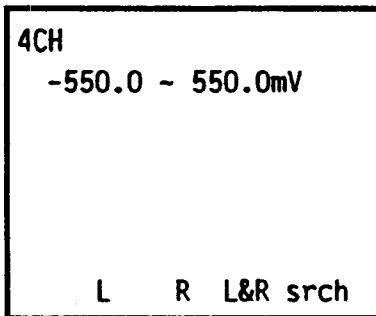
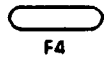

Press the F4 key to set the optimum span. Press the F4 key for a few seconds.  
\* When srch is not made, this setting is not required.

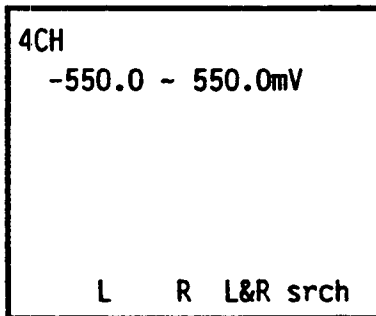
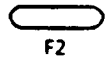

Press the F2 key to change SPAN RIGHT to 450 mV.

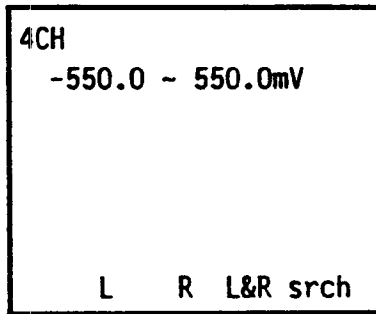

Select 450.0 mV by turning the setting knob to the left.

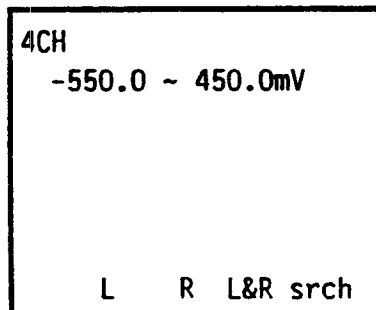
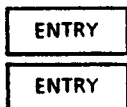

Pressing the ENTRY key twice returns the display to the original display panel.



### 6.4.5 RECORDING AREA ADJUST (Zone recording)

**Function :** The recording area (zone) can be freely set by the pen position. Since the pen position can be matched to a main division on the chart. Chart expansion and contraction can be corrected by setting the left side (Left) of the recording area to 0% and the right side (Right), to 100%.  
Reference Recording chart may expand or contract up to approximately 2mm when the humidity changes from 30 to 80% at the temperature of 23°C.

**Setting Item :**

- ① CH : Channel No.
- ② L : Recording position at left
- ③ R : Recording position at right

**Setting Example :**

- ① CH : 4
- ② L : 50%
- ③ R : 100%

**[Key operation]**



**[Setting display]**

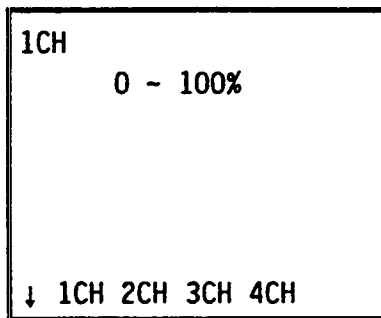

**[Description]**

Press the RECORD AREA ADJ key.  
Press the F4 key to select CH4.  
For the one-pen model CH input is not available.

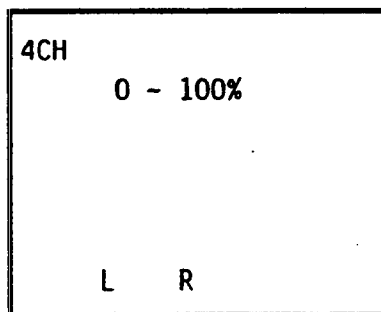

Set the pen position to the Left (50%) value by turning the setting knob, then press the F2 key.

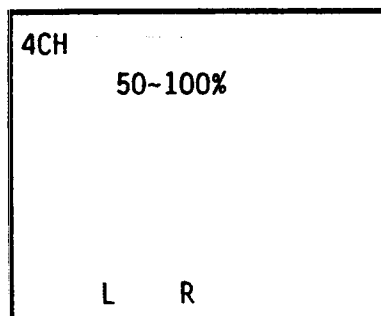

Match to the Right (100%) position by turning the setting knob.  
Pressing the ENTRY key twice returns the display to the original display panel.

### 6.4.6 Alarm Setting

**Function**

:

The two level alarms can be set per one channel. When an alarm occurs, the alarm can be printed out (RD3721 only) or output (option).

**Setting Item**

- : ① CH : Channel No.  
 ② L1 or L2 : Level 1 or 2  
 ③ MODE : H(high limit) or L(low limit)  
 ④ VAL : Alarm set-value  
 ⑤ RLY : Relay No. (1 to 4)

Can be set, but output is optional.

**Restrictions**

- : (1) Alarm setting may be turned OFF if the RANGE of the relevant channel is changed.

Therefore, carry out alarm setting after RANGE setting.

- (2) For the one . pen model CH input is not available and display of possible setting range is also not available.

**Setting Example :**

- ① CH : 4  
 ② MODE : L1  
 ③ VAL : 1.000 V  
 ④ RLY : 1

[Key operation]

[Setting display]

[Description]



AUX

↓ ALM TAG RCD MSG

↓ CLK RAM

Pressing the AUX key turns the mode to the AUX mode to show the menu at the bottom of the display panel.  
Press the F1 key to output the alarm (ALM) setting display panel.

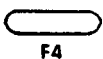

1CH (-5.500~5.500)  
LI MODE : OFF  
L2 MODE : OFF

1CH 2CH 3CH 4CH

Press the F4 key to select CH4. The alarm range that can be set is displayed in parentheses after the CH No.

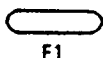

4CH (-5.500~5.500)  
LI MODE : OFF  
L2 MODE : OFF

H L OFF

Press the F1 key to change the L1 (level 1) alarm mode to H.

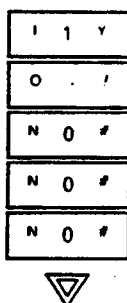

4CH (-5.500~5.500)  
LI MODE : H  
VAL : 0.000V  
RLY : OFF  
L2 NODE : OFF

← → del

Set the alarm high-limit to 1.000V using the numeric keypad.  
Then press the cursor key.

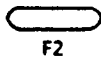
**[Key operation]****[Setting display]****[Description]**

```

4CH(-5.500-5.500)
L1 MODE : H
  VAL : 1.000V
  RLY : OFF
L2 MODE : OFF

↓ OFF  1  2  3
  
```

Press the F2 key to select the output relay No. (1).

( Relay output is not made available if the optional code /AK-04 is not provided. )

4



```

4CH (-5.500-5.500)
L1 MODE : H
  VAL : 1.000V
  RLY : 1
L2 MODE : OFF
  
```

Keep L2 (level 2) turned OFF. Pressing the ENTRY key once makes the alarm setting effective.

When ending the setting, press the ENTRY key again.

**Notes :**

1. Alarm detection sampling is made every second. Therefore, it may take 1 sec. to detect the alarm after it is activated.
2. A slight variation in the measured-value may cause alarm ON / OFF repetitions. To prevent this, alarm hysteresis must be set. For details, refer to the SET UP mode in Section 6.4.14

### 6.4.7 TAG No. Setting (RD3721 only)

**Function :** A Tag No. of up to 7 characters representing the measured object can be set instead of the channel No. (1 to 4).

**Setting Item :** TAG1 to 4  
Letters and numerics up to 7 characters.

**Setting Example :** Tag No. 1 is set to RD3721

**[Key operation]**

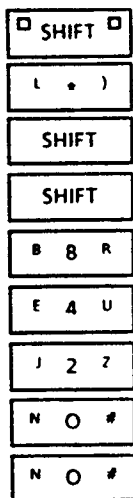
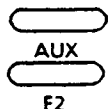

**[Setting display]**

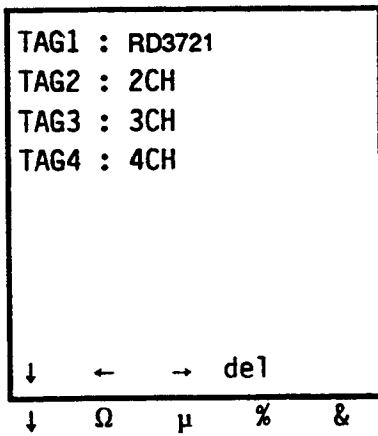
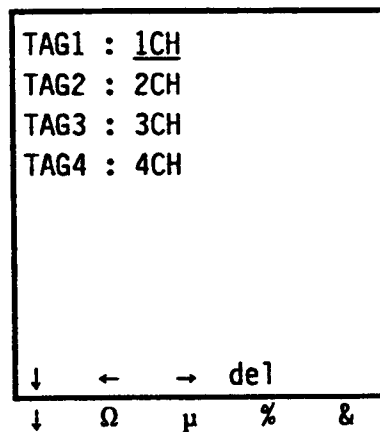
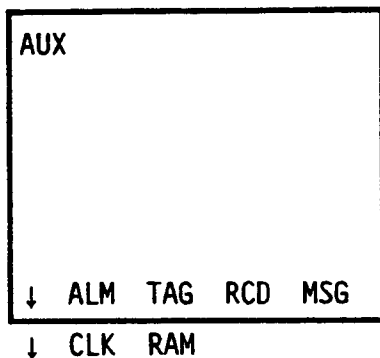

**[Description]**

Pressing the AUX key sets the mode to the AUX mode and as a result, the menu is shown at the bottom of the display. Press the F2 key to show the TAG setting display panel.

Set TAG1 to RD3721

When setting the Tag No. after TAG2, press the cursor key. After the setting is finished, press the ENTRY key. The setting becomes effective when the ENTRY key is pressed once.

Pressing the ENTRY key again returns the display to the original display panel.

### 6.4.8 Partially Suppressed and Expanded Recording Setting

**Function :** For recording, the unnecessary recording section is suppressed and important recording section is extended.

- Setting Items :**
- ① CH Channel No.
  - ② PARTIAL : Partially suppressed and extended
  - ③ RATE : Partial suppression factor
  - ④ BDY : Partial suppression boundary value

- Restrictions :**
- ① This function must be turned ON in the SET-UP mode. (Refer to Section 6.4.14.)
  - ② This function is turned OFF if RANGE (MODE,RANGE, SPAN and scaling) is changed. Set this function after RANGE setting is finished.

- Setting Example :**
- ① CH : 4CH
  - ② PARTIAL : ON
  - ③ RATE : 25%
  - ④ BDY : 1.000 V

[Key operation]

[Setting display]

[Description]

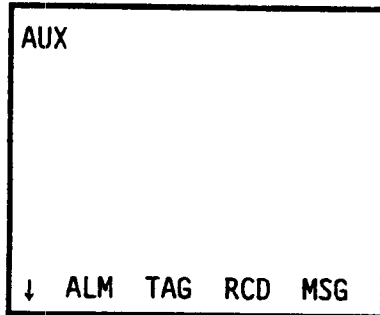
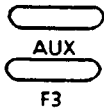

Press the AUX and F3 keys. The display is changed to the PARTIAL setting display panel.

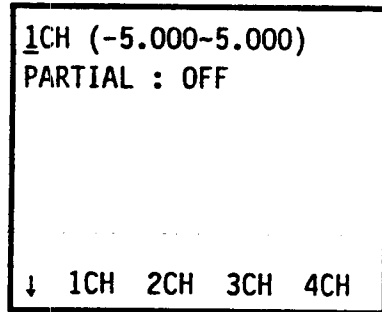

Press the F4 key to select CH4. Figures in ( ) on the right of the CH No are SPAN. BDY setting can be made within this range.

For the one-pen model, CH input and SPAN display are not available.

**[Key operation]**

**[Setting display]**

**[Description]**



4CH (-5.000~5.000)  
PARTIAL : OFF  
  
ON OFF

Press the F1 key to turn PARTIAL ON.

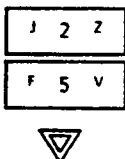

4CH (-5.000~5.000)  
PARTIAL : ON  
RATE : 10%  
BDY : 2.500V  
  
← → del

Set RATE to 25%, then press the cursor key.

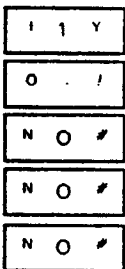

4CH (-5.000~5.000)  
PARTIAL : ON  
RATE : 25%  
BDY : 2.500V  
  
← → del

Set BDY to 1.000 V.

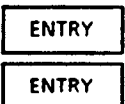

4CH (-5.000~5.000)  
PARTIAL : ON  
RATE : 25%  
BDY : 1.000V

After setting is finished, press the ENTRY key. The setting becomes effective when the ENTRY key is pressed once. Set the other channel in succession when required. Pressing the ENTRY key again returns the display to the original display panel.

**Example of partially expanded / suppressed - scale recording.**

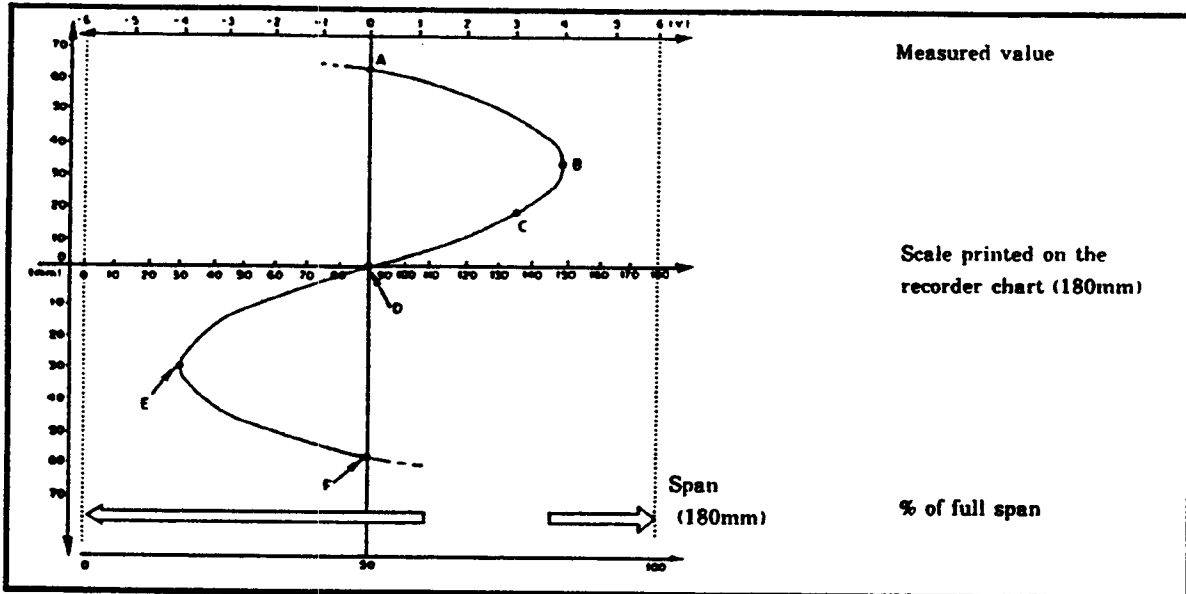

Figure A

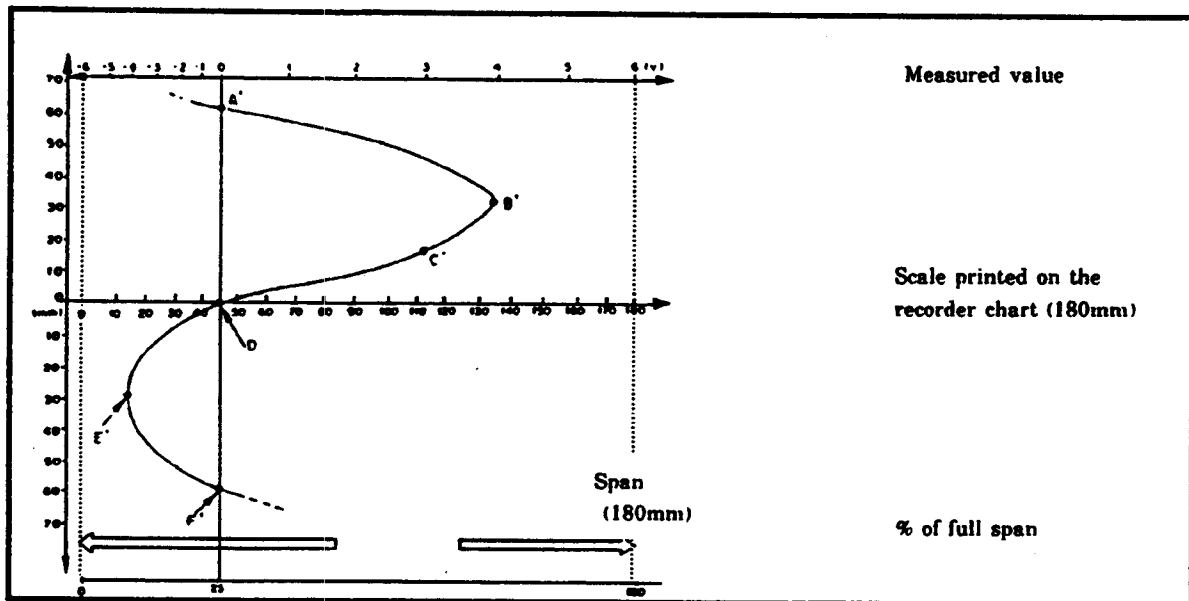

Figure B

(Explanations of partially expanded/suppressed-scale recording)

- Figure A shows the ordinary recording when the span is set to 180mm. At this time point 0V is located at 90mm (50% of span) from the left edge on the recorder chart (measured value full span (-6 to 6V) is set to 180mm).
- Figure B shows the partially suppressed scale recording. At this time point 0V is located at 45mm (25% of span) from the left edge on the recorder chart (measured value full span (-6 to 6V) is set to 180mm).

It is clear that bordering on the partially suppressed border value, the value of recording span (180mm in the example) multiplied by numerical value (%) of the partially suppressed scale recording width, and the value of recording span multiplied by the value (%) subtracted the partially suppressed scale recording width from 100 are allocated to the left hand side (here indicates negative side) on the recorder chart and the right hand side (here indicates positive side) respectively.



### 6.4.9 AUTO Span Shift Mode Setting

- Function** : When input exceeds the recording span, the +50% span is shifted automatically to continue recording.
- Setting Items** : ① CH : Channel No.  
② AUTO SPAN SHIFT : AUTO Span Shift ON/OFF
- Restrictions** : ① This mode must be turned ON in the SET - UP mode. (Refer to Section 6.4.14.)  
② This mode can be used only when RANGE is in VOLT, TC or RTD and/or COM. (NO DELTA, SCALE and MATH can be set.)  
③ If RANGE is changed to OFF, DELTA, SCALE or MATH, this mode is turned OFF automatically. Set this mode after RANGE change.  
④ The span shift range is up to VOLT range + 10% (For the 1V range : 1.1 V, and for ranges other than VOLT : within their measuring ranges.)
- Setting Example** : ① CH : 4  
② AUTO SPAN SHIRT : ON
- For example, in the range 1V, when the span 0.0 to 1.0V is set, by shifting for 50%, the span will be 0.5V to 1.5V.  
However the shift range is up to 1.1V, so 0.1V to 1.1V is the actual value.
- On the negative side, -0.5V to 0.5V are within the measuring range, so this will be the actual shifted span.
- <Span shift example for 0 to 1V input>

<Span shift example for 0 to 1 V input>

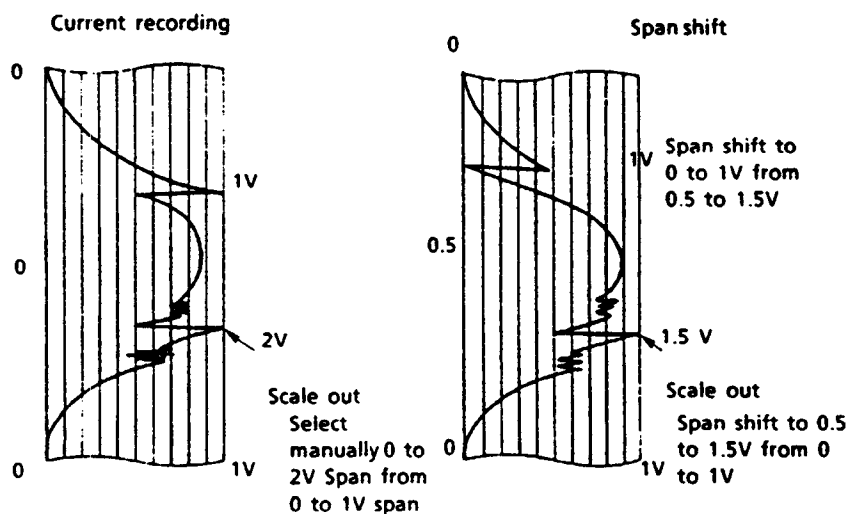

- \* If an over-range occurs, the manual range compensation is not required.
- \* Refer to section 2. 3 for recording examples.

**[Key operation]**

**[Setting display]**

**[Description]**

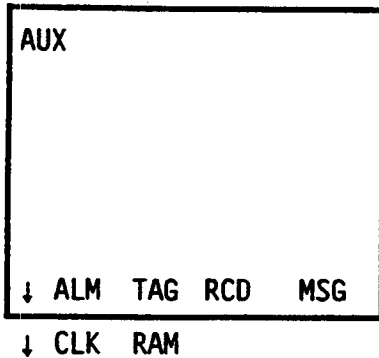
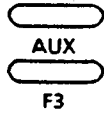

Press the AUX and F3 keys. The display changes to the AUTO SPAN SHIFT setting display panel.

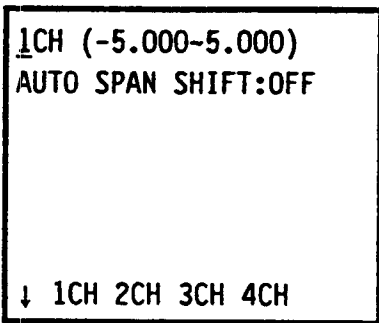
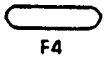

Press the F4 key to select CH4. CH selection is not available for one-pen model.

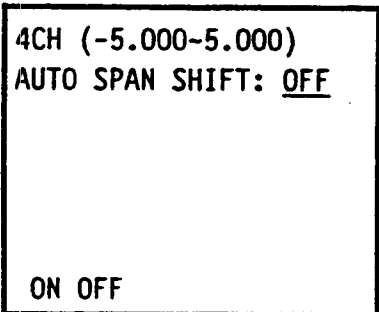
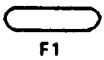

Press the F1 key to turn AUTO SPAN SHIFT ON.

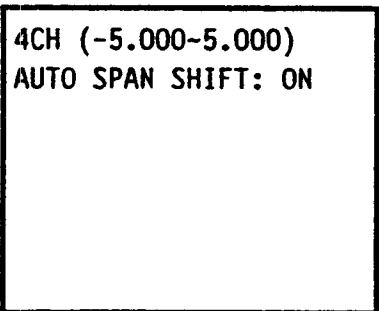
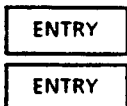

After setting is finished, press the ENTRY key. The setting becomes effective when the ENTRY key is pressed once. Set the other channels in succession when required. Pressing the ENTRY key again returns the display to the original display panel.

### 6.4.10 Message Setting (RD3721 only)

- Function** : Print-out is made when a message of up to 70 characters is set, and the MANUAL MESSAGE key at the front is pressed (MESSAGE 0), or optional external contact input (MESSAGE 1 to 4) is accepted.
- Setting Items** : Letters or numerics of up to 70 characters.
- Restrictions** : MESSAGE 1 to 4 can be set, but no print-out is made when no optional remote function (/REM) is provided. Print-out by the communication function is available.
- Setting Example** : Set MESSAGE 0 to SW1 ON.

#### [Key operation]

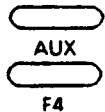

#### [Setting display]

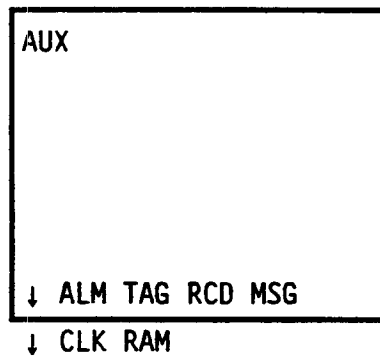

#### [Description]

Pressing the AUX key sets the mode to the AUX mode to show the menu at the bottom of the display panel. Press the F4 key to show the MESSAGE (MSG) setting display panel.

**[Key operation]**

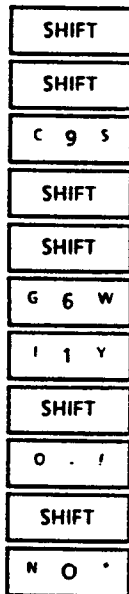

**[Setting display]**

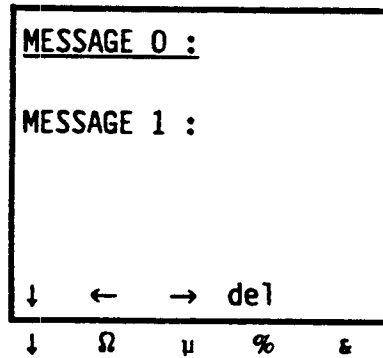

**[Description]**

Set MESSAGE to SW1 ON. For lower case letters, make the setting after the CAPS key is pressed.

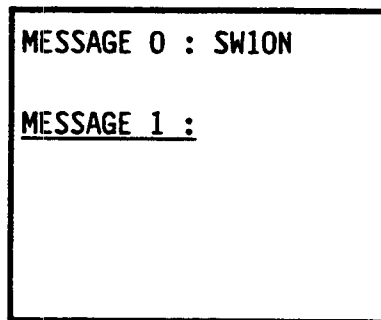

When setting the Tag No. after MESSAGE1, press the cursor key.

After the setting is finished, press the ENTRY key. The setting becomes effective when the ENTRY key is pressed once. Pressing the ENTRY key again returns the display to the original display panel.

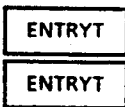

### 6.4.11 Time Setting

**Function** : Set year, month, day, hour, min., and sec.

**Setting items** : ① DATE : Year / month / day  
 ② TIME : Hour / min. / sec.

**Setting example** : ① DATE : Feb. 1, 1988  
 ② TIME : 12 - hour, 34 - min. and 56 - sec.

**[Key operation]**

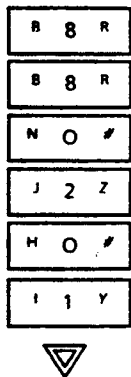
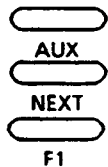

**[Setting display]**

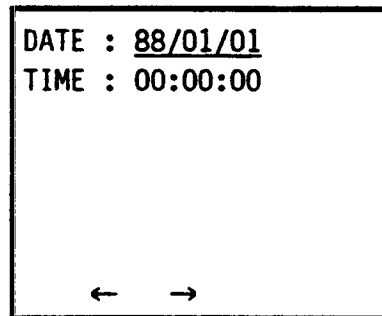
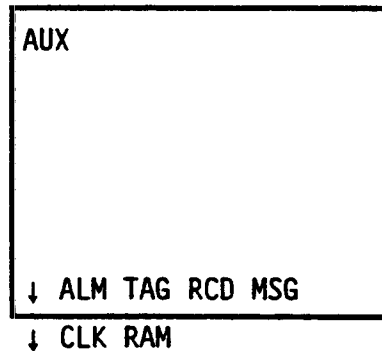

**[Description]**

Pressing the AUX key sets the mode to the AUX mode. Press the NEXT and F1 keys to show the time (CLK) setting display panel.

Set the data to Feb. 1, '88. When only certain numerics are changed, shift the digit by pressing the F1 or F2 key to set the new numerics, then press the cursor key.

**[Key operation]**

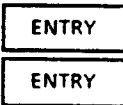
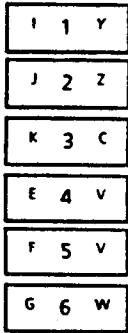

**[Setting display]**

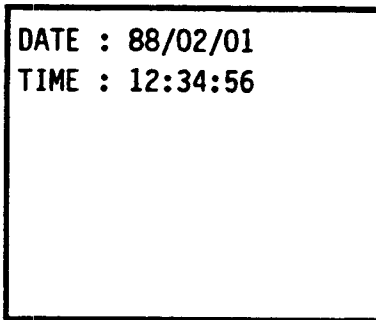
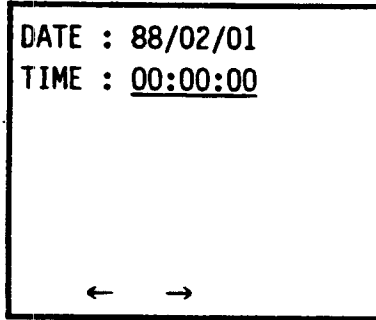

**[Description]**



Set the time to 12 hours, 34 min. and 56 sec.  
When only certain numerics are changed, shift the digit by pressing the F1 or F2 key to set the new numerics.  
Time is changed every 24 hours.

After setting is finished, press the ENTRY key twice.  
Time is enabled when the ENTRY key is pressed once.

### 6.4.12 Set-value Initialization (RAM CLEAR)

**Function** : Setting information currently set (excluding CLOCK) is all initialized.

**[Key operation]**

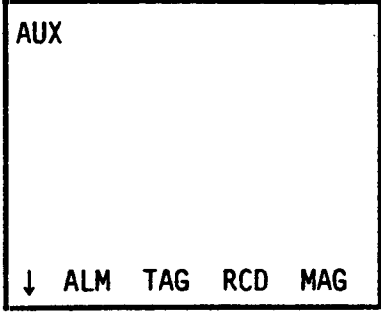

  
 AUX  
  
 NEXT  
  
 F2

**[Setting display]**

  
 AUX  
  
 ↓ ALM TAG RCD MAG  
 ↓ CLK RAM

**[Description]**

Pressing the AUX key sets the mode to the AUX mode. Press the NEXT and F2 keys to show the RAM CLEAR setting display panel.

  
 F1  

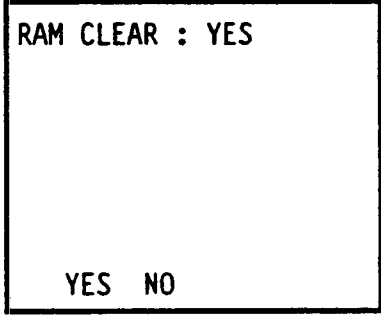

  
 RAM CLEAR : YES  
  
 YES NO

When returning to the initial setting, press the F1 key. To suspend the procedure at this stage, press the F2 key. The setting becomes effective when the ENTRY key is pressed once, the display then returns to the original display.

### 6.4.13 IC Memory Card Setting

**Precautions**

There are two types of IC memory cards as follows :

Standard Card (Part No. RD-MC8) . . . . . Memory Capacity 8KB

Optional Card (Part No. RD-MC256) . . . . . Memory Capacity 256 KB

**1. 8KB IC memory card**

**Function**

: The contents of settings such as range, etc. corresponding to up to 5 files can be stored in an IC memory card and used as required.

**Setting Items :**

- ① SET : Set condition SAVE (write) and LOAD (read) and File name registration (up to 8 characters).
- ② INIT : IC memory card initialization and VOLUME name registration during initialization (up to 6 characters).

**Operation :**

- ① Load the lithium cells attached to the IC memory card by referring to Section 6.2.6.
- ② Face the up and down display mark of the IC memory card to downward, then insert the IC memory card into the slot on the right front side of the mainframe. If the mark is upside down, the card cannot be inserted into the slot.
- ③ IC memory card initialization When the IC memory card is used for the first time after delivery, it must be initialized. The user's name and experimental details of up to 6 characters can be set for each IC memory card as VOLUME name during initialization. If an IC memory card already holding the set-value is initialized, the contents of the memory may be deleted.
- ④ When operating MENU, if message \*\* CARD BAT \*\* is displayed, the IC memory card batteries are worn out. Replace the batteries as per paragraph 6.2.6.



<Setting Information Memory>

**Setting example**

- (1) Initialize the IC card, then register the VOLUME name
- (2) Register FILE1 as LR1 to perform SAVE and LOAD.

**[Key operation]**



**[Setting display]**

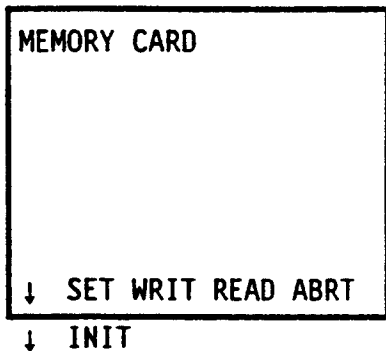

**[Description]**

Press the MEMORY CARD function key to show the setting display panel.  
Press the NEXT and F1 keys (INIT) to show the initialize display panel.

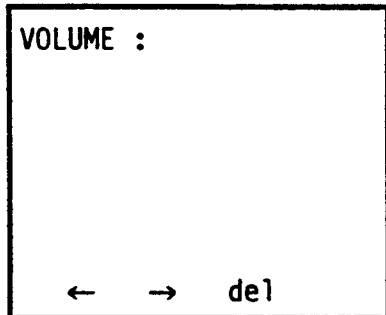
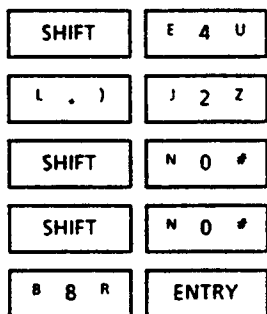

Register the VOLUME name as RD3721/RD3722. (Error occurs in all spaces)

Press the ENTRY key to end initialization.  
The display shows the MEMORY CARD menu.

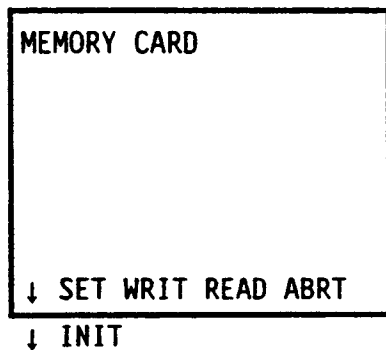
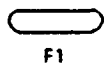

This is the operation for saving currently set setting information. First, press the F1 key (SET) to show the setting information memory menu.

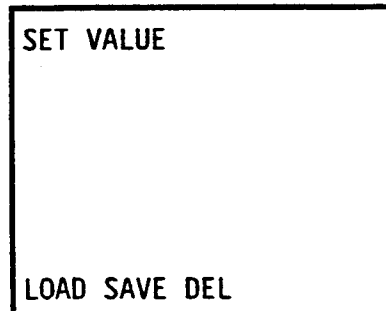

Press the F2 key (SAVE) to show the SAVE setting display panel.  
When deleting setting information which is no longer necessary, press the F3 key (DEL).

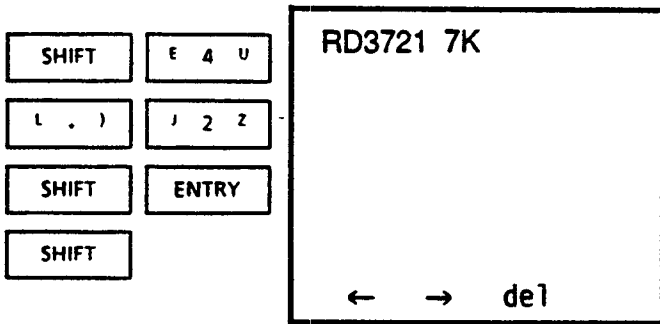

Enter the FILE name (LR1), then press the ENTRY key to end SAVE.

In addition, residual memory (unit : KB) is displayed between the VOLUME and FILE names.

When the FILE name has already been entered, select the file name with the cursor key.

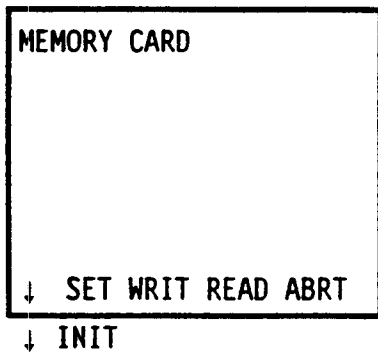
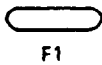

This is the operation for loading the setting information which has been saved in LR1. First, press the F1 key (SET).

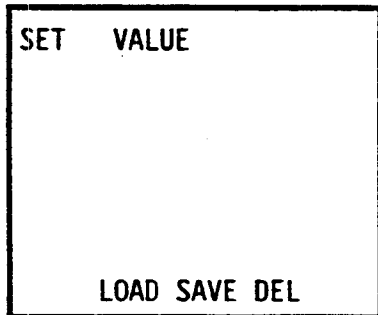
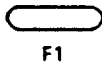

Press the F1 key (LOAD) to show the LOAD setting display panel.

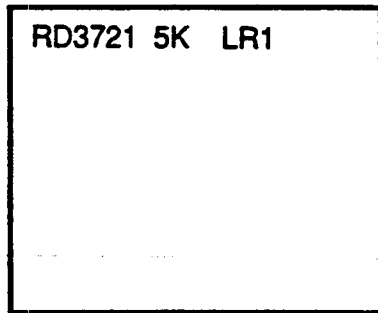

Select the FILE name to be loaded by the cursor key. Since there is only FILE1 (LR1) here, FILE1 can be loaded simply by pressing the ENTRY key.

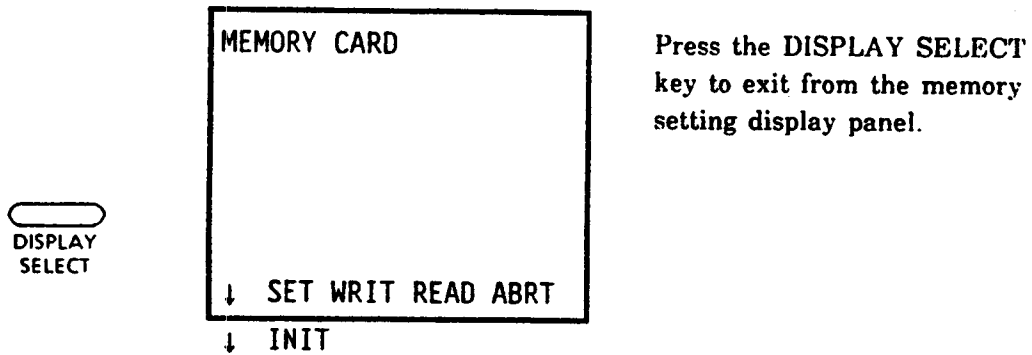

### Notes:

- The standard IC memory card (8K bytes) cannot store measured values (which is possible with optional RD-MC256). Therefore, the MEMORY CARD menu on the setting display panel shows WRIT (F2), READ (F3) and ABRT (F4) which cannot be used without optional IC memory card RD-MC256.
- The IC memory card has a seal attached to it for VOLUME and FILE entry. However, never stick the seal to the grounding surface at the rear center of the IC memory card as the effectiveness of the static electricity measures is lost and the stored content may be detected.

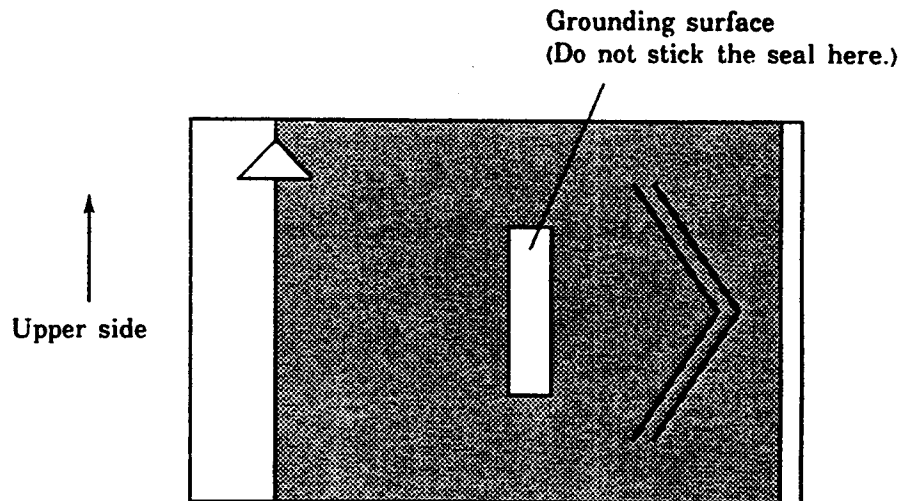

- IC memory cards being used for the first time must be initialized, otherwise, they will not be effective.

## 2. 256KB IC Memory Card

### Function

An IC memory card is used to store measured and panel setting data.

The measured data storing function is manually or trigger executed by alarms CHART END or external contact signals.

Interface input data and computed data ( /MATH Model) can also be stored.

Stored panel setting data can be easily retrieved from the memory card for repeated use in the recorder.

Stored data can also be read and transmitted at any time.

### Setting Items

SET : Loads and saves panel setting data.

WRIT : Sets writing (sampling) conditions and writes measured data.

READ : Sets readout conditions and prints out measured data (sampled data)

ABRT : Interrupts WRITE or READ operations.

INIT : Initializes the memory card.

### Operation

Items (1) to (4) are the same as those of the previous section

## 1. 8KB IC Memory Card (RD-MC8) (see 6 - 67)

### <Setting Informaion Memory>

#### Setting Example

Same as the example described in the previous section. (See p6 - 67 to p6 - 70.)

## <Measured Data Memory>

### 1. Preliminary

- (1) Each card has a 256 byte memory capacity, which is used to store measured and panel setting data.

A total number of 47 files can be stored in the memory.

Two files are always required : one for measured data, the other for setting data.

- (2) The card dedicates 1K to 3.5 byte to file management (1K : 8K card, 3.5k : 256K card) Therefore, 255K bytes is available for data storage.

1.35K bytes/file is used for panel setting data. The required measured data capacity calculation is given below.

- (3) Every measured data file produced, produces a corresponding setting data file.

- The measured data file size is calculated as follows.

$$([Sampled\ data\ length] \times 2) \times [Sampling\ channel\ number] + \underline{512}$$

↓

File header information data length

Sampled data length : Sampling length designated data length

Sampling channel number : Channel number with RANGE ON.

- 1000 bit 4 channel data  
 $(2 \times 1000 \times 4 + 512) / 1024 = 8.3125$   
 uses about 8K bytes.
- 32000 bit 4 channel data  
 $(2 \times 32000 \times 4 + 512) / 1024 = 250.5$   
 uses about 250K bytes. Here 1K byte = 1024 bytes
- A panel setting data file simultaneously produced with a measured data file always requires 1K byte of memory (equivalent to one channel).

- (4) The IC card (256K bytes) has a maximum of 48 files.

Example :

$$\left. \begin{array}{l} \text{Number of panel setting data files; } 3 \\ \text{Number of measured data files; } 4 \end{array} \right\} \text{ The number of files} \\ 3 + 4 \times 2 = 11$$

↑

One measured data file produces one panel setting data file.

### Memory Card Data

(1) MATH data which is computed with computational expressions comes after the measurement data stored in the memory card (see the figure below).

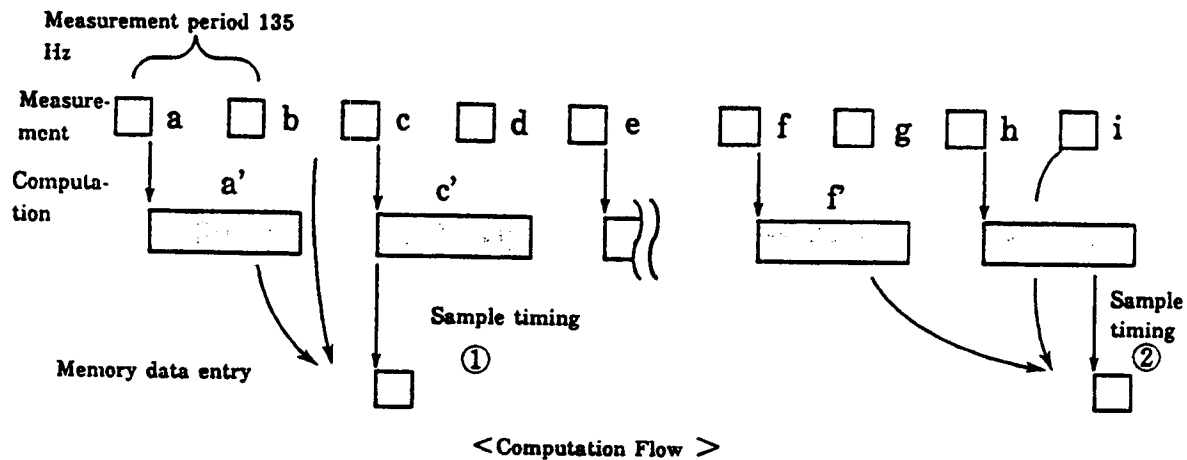

Refer to the figure above as an aid to the following explanation:

In sample timing (1), the measured data (c) and computed value a' are entered in the memory data entry area. a' is a computation result from the measured data a. In sample timing (2), the measured data "i" and computed value f are entered in the memory data entry area. The computation results are taken from previously measured data.

Note: Panel display and recording data are output simultaneously. Measured data sent via communications is displayed simultaneously with the panel display or recording data.

(2) Reading stored data.

Data in a computation channel, which is already stored in the memory card, can be computed and read. This permits modification of the computation expressions and data to be re-calculated.

When computational constants are modified and used for the computation of new data, press the F1 key to turn OFF the data entry set and start computation.

**Note:** When communications input values (C1 to C4) are used in the computation channel in the memory card, send these values via communications for data reading. Data in measurement mode (COM) is stored in memory, so this data can be read easily.

When communications input data (C1 to C4) must be displayed, proceed as follows:

**(Example)**

Set channel 1 to COM and apply a communications input value to channel 1 with CV1. Set channel 2 to "MATH". Set computational expressions using data in channel 1 (do not use C1 in this case).

When data is read an input channel is set with computational expressions after which data can be computed.

<Measured Data Memory>

Writing Data (WRITE)

**Function** : Writes measured data onto the IC memory card while simultaneously producing measuring ranges and coefficients (/MATH option).

- Setting Items** :
- ① **FILE** : Setting measuring conditions
    - FILE Name; max. 8 characters
    - MEM LEN; Data length setting  
1000/2000/4000/8000/16000/32000 data/CH
    - TRIG MODE; Trigger mode on or off
    - SAMPL; Sampling rate setting 0.2/0.5/1/3/5/9/135 Hz
    - PRE TRIG; Used when TRIG MODE on.  
0 to 100%, 10% increments
  - ② **DEL** : Deletes unnecessary files.

- Setting Example** :
- ① **FILE Name** : LR 1
  - ② **MEM LEN**: 2000 (2K)
  - ③ **TRIG MODE** : ON
  - ④ **SAMPL** : 9 Hz
  - ⑤ **PRE TRG** : 10 %
  - ⑥ **TRIGGER** : Alarm Only ON.

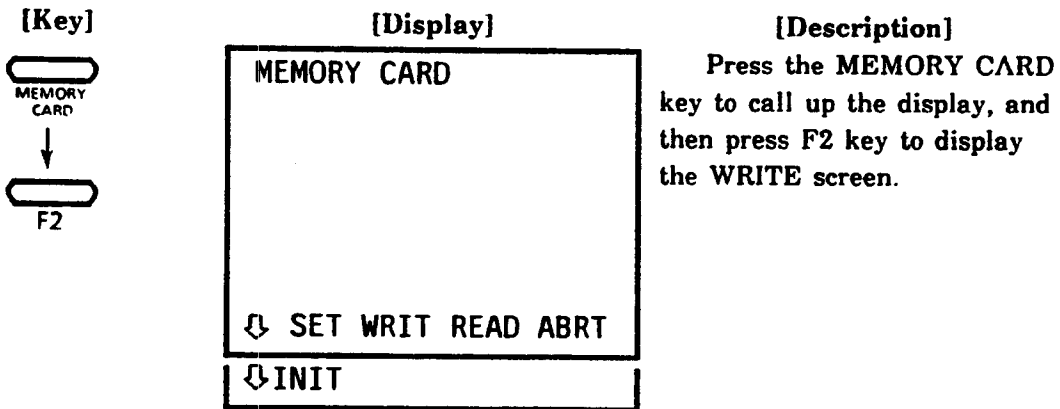



F1

WRITE

FILE DEL

Press F1 (FILE) key to register the file name.

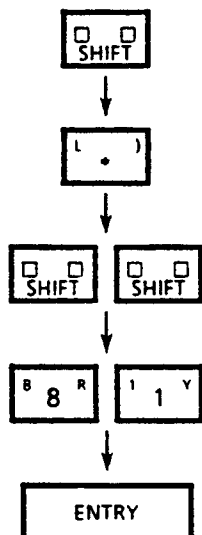

LR1 255K

← → DEL

Enter LR1.  
Total number of 47 files are shared by SET and WRITE.

The same name can be used with both SET and WRITE because they are independent of each other.  
Press ENTRY key.

F2

MEM LEN : 2000

TRIG MODE : OFF

SAMPL : 135Hz

⇩ 1K 2K 4K 8K

⇩ 16K 32K

Press F2 key to enter 2000 (2K) into MEM LEN.

All channels excepting those with RANGE OFF can sample respective data.



  
F1

```
MEM LEN : 2000
TRIG MODE : OFF
SAMPL : 135Hz

ON OFF
```

Press F1 key to turn ON the TRIG MODE.

In TRIG mode, if any of trigger conditions — ALARM, CHART and RMT — is true (satisfied), data entry is started. In free mode, data entry is started manually.

  
NEXT  
↓  
  
F2

```
MEM LEN:2000
TRIG MODE:ON
SAMPL:135Hz
PRE TRIG:10%
TRIG ALARM:ON
TRIG CHART:OFF
TRIG RMT :OFF
↓ 0.2 0.5 1 3
↓ 5 9
```

Set the sampling rate (SAMPL) to 9 Hz.

The sampling rate can be selected from 0.2, 0.5, 1, 3, 5, 9 and 135 Hz.

  
F2

```
MEM LEN : 2000
TRIG MODE : ON
SAMPL : 9Hz
PRE TRIG : 10%
TRIG ALARM:ON
TRIG CHART:OFF
TRIG RMT :OFF
↓ 0 10 20 30
↓ 40 50 60 70
↓ 80 90 100
```

Set the PRE TRIG to 10% which allows MEM LEN to memorize an extra 10% of the data before the trigger acts.

In the free mode (when the TRIG MODE is OFF), start waiting press the ENTRY key

  
F2

MEM LEN : 2000  
TRIG MODE : OFF  
SAMPL : 9Hz  
PRE TRIG:10%  
TRIG ALARM:ON  
TRIG CHART:OFF  
TRIG RMT :OFF  
ON OFF

Set TRIG ALARM. In TRIG ALARM ON status, alarms are entered in memory.

  
F1

MEM LEN : 2000  
TRIG MODE : OFF  
SAMPL : 9Hz  
PRE TRIG:10%  
TRIG ALARM:ON  
TRIG CHART:OFF  
TRIG RMT :OFF  
ON OFF

Set TRIG CHART. In TRIG CHART ON status, data is entered in the memory card when the recorder is out of paper.

  
F1

  
ENTRY

MEM LEN : 2000  
TRIG MODE : OFF  
SAMPL : 135Hz  
PRE TRIG:10%  
TRIG ALARM:ON  
TRIG CHART:OFF  
TRIG RMT :OFF  
ON OFF

Set TRIG RMT. In TRIG RMT ON status, when /REM option is added, data is entered in the memory card with a remote contact input. When the ENTRY key is pressed, the recorder is in the trigger wait status. Data entry is started in the free mode (in "TRIG MODE OFF") when the ENTRY key is pressed.

DISPLAY  
SELECT

MEMORY CARD
↓ SET WRIT READ ABRT
↓ INIT

To exit from the MEMORY CARD display, press the DISPLAY SELECT key.

To abort writing, press F4 (ABRT) key.

## [Trigger Conditions]

### ① Pre-trigger

For data sampling in the trigger mode use the pre-trigger.

The pre-trigger is detected only for trigger set point values over 0%.

Any data prior to the pre-trigger data is ignored. Sampling continues for data following the trigger sampling period.

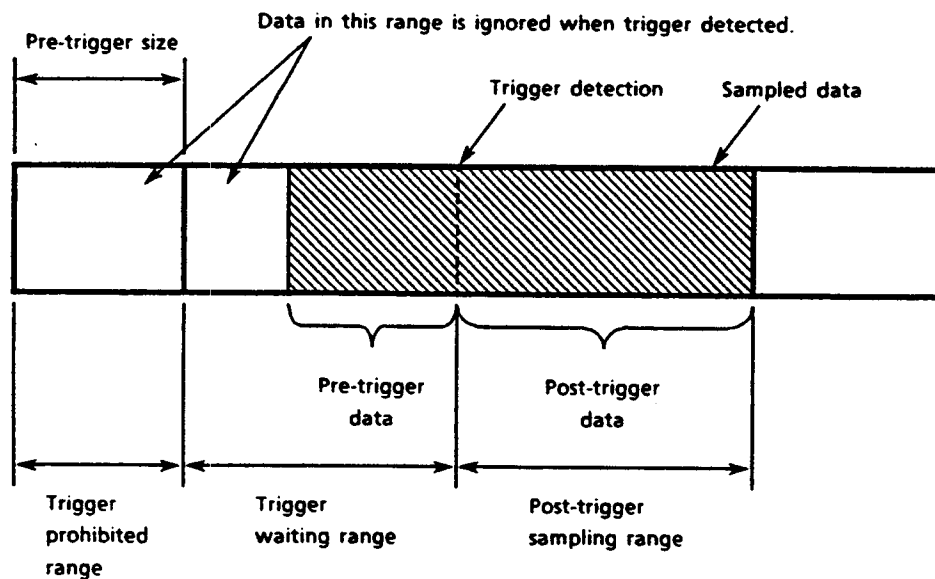

## ② Internal Alarm Trigger

A trigger can be produced in an alarm state.

At the beginning of the trigger waiting range, the alarm having already occurred produces a trigger during the sampling period.

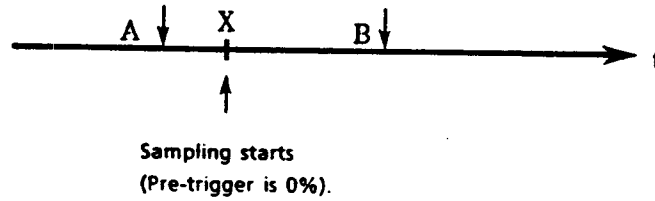

- The trigger is detected at point X when the alarm occurs at point A and sampling starts from point X.
- The trigger is detected at point B when sampling starts from point X and the alarm occurs at point B.

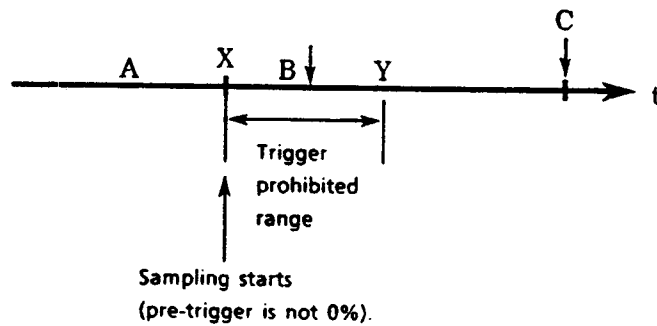

- If the alarm occurs at point A or B the trigger is detected at Y.
- If the alarm occurs at C the trigger is detected at C.

### ③ Alarm Trigger Detection

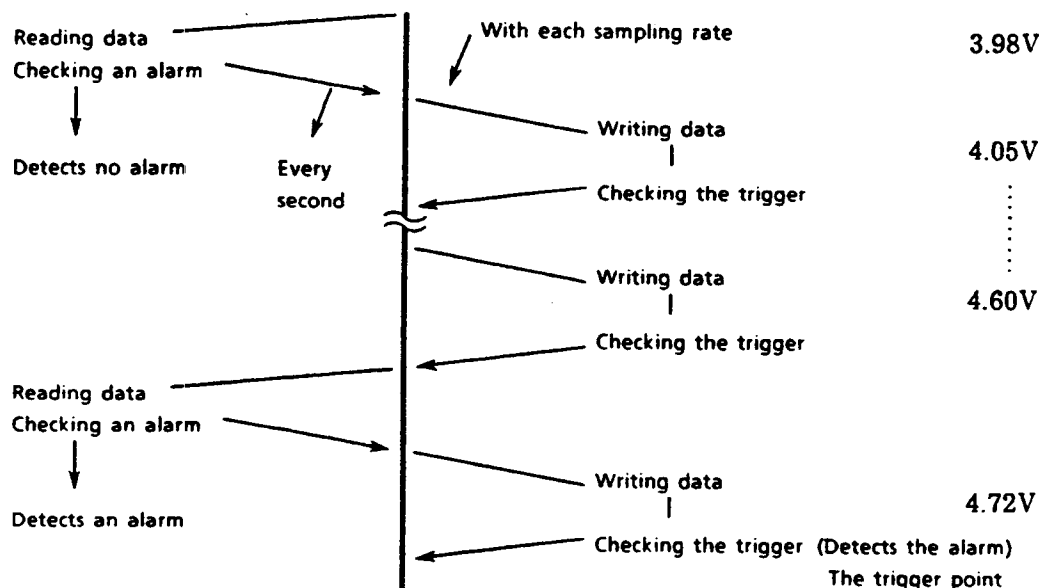

Assume that a high alarm is set at 4V.

On the initial search, an alarm is not detected as the sampled data is 3.98V. When the sampled data reaches 4V, the alarm is detected 1 second later at 4.60V. The trigger is then detected from the sampled data.

Therefore, data exceeds the alarm level prior to reaching the trigger point.

Especially, when sampling is executed in 135Hz in trigger mode, several tenth points alarm data may exist prior to the beginning of the trigger.

## [WRITE Completion Conditions]

Data sampling terminates upon any one of the following conditions:

- (1) Sampling completion of data assigned to the data length.
- (2) Measuring condition variation detection. e.g. measuring range change.
- (3) Using the F4 ABRT key.

In the case (3) above, if trigger has not been detected, the data file cannot remain in the IC memory card.

## [WRITE Indication]

During data sampling, an (\*) appears in the sampling channel as shown in the figure below (only for the channel displaying the measuring data).

1ch	110.00mV 1200mm/H *	Sampling data mark
2ch	L-120.00mV 18:35:45	
3ch	90.84mV Oct.13.87	
4ch	-12.33mV	

### CAUTION

Do not remove the IC memory card from the recorder while writing, as data sampling will be interrupted and data already entered will remain on the IC memory card.

Sometimes sampling continues for a few seconds after removal of the card (the time period is determined by the sampling rate).

- (1) Data remaining on the card cannot be used as the file ends incorrectly. Note therefore that when reusing this stored file the incomplete file is ignored. However, the file remains stored in the card.
- (2) The incomplete file can be deleted along with other files by using the DEL function in the MEMORY CARD WRITE menu.



## Reading Data (READ)

- Function** : Performs IC memory card measured data printouts or produces interface outputs (optional).
- Setting Items** :
- ① FILE : Sets necessary data output conditions.
    - FILE Name ; File name to be output.
    - SAMPL ; 0.2/0.5/1/3/5/9/135 Hz
    - START; Set the output start point
    - LOAD ; Decides whether measured data and panel setting data effective while in DATA.
  - ② INFO : Indicates the DATA panel setting data.
- Setting Example** :
- ① FILE Name : LR1
  - ② SAMPL : 9 Hz
  - ③ START: 1
  - ④ LOAD : OFF

[Key]

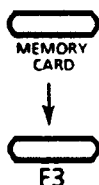

[Display]

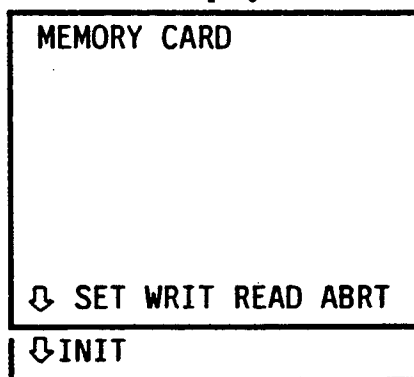

[Description]

Press the MEMORY CARD key, then the F3 key to display the READ panel.

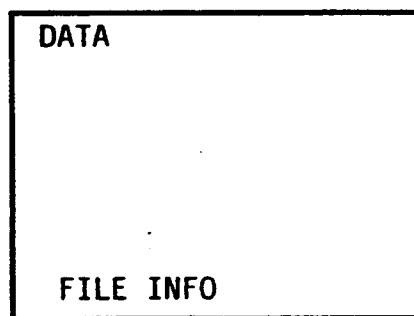

Press F1 key to call up the FILE setting display.  
To display the INFO panel, press F2 key.

ENTRY

```
RD3721 8K LR1
FILE02  FILE03
```

Select the file to be retrieved using the cursor.  
In this example, only press the ENTRY key because the file name is LR1.

NEXT  
↓  
F2

```
SAMPL : 135Hz
START : 1
LOAD  : ON
↓ 0.2  0.5  1  3
↓ 5    9  135
```

To select SAMPLE 9 Hz, press ENTRY then F2 key.

▽

```
SAMPL : 9Hz
START : 1
LOAD  : ON
```

Set the output start point. In this example, output begins from data 1. Therefore, no change to the display is necessary. Continue to the next screen using the cursor key.

An error message appears if the set data length exceeds DATA LEN in the INFO display.

F1  
↓  
ENTRY

```
SAMPL : 9Hz
START : 1
LOAD  : ON

ON OFF
```

Press F1 to load the printout conditions (data for RANGE or /MATH).

Press ENTRY to execute READ.



<p>MEMORY CARD</p>
<p>⇓ SET WRIT READ ABRT</p>
<p>⇓ INIT</p>

Exit from the MEMORY CARD screen by pressing the DISPLAY SELECT key.

Press the F4 (ABRT) key to terminate the READ process.

### CAUTION

- (1) If LOAD is ON when setting the necessary items, the recorder reads the setting (RANGE, SPAN) and measured data. Setting data entering the recorder overrides the current setting data.
- (2) When LOAD is OFF, the measuring range or chart speed can be READ through the panel setting condition display.  
If the measuring range differs from the sampling set range, the indicated and recorder printed characters differ from those at sampling even though the recorded waveform is similar to the original one.  
The non-selected channel sampling data (OFF) is not reproduced. The OFF channel shows current input data.

## [READ Indication]

During reading, an (\*) appears in the reading channel as shown in the figure below (only for the channel showing the measuring data).

1ch	110.00mV 1200mm/H *	Data reading mark
2ch	L-120.00mV 18:35:45	
3ch	90.84mV Oct.13.87	
4ch	-12.33mV	

## [READ Completion Operations]

- (1) Reading is terminated automatically after the recorder READs all assigned data. The memory channel changes to RECORD OFF. To restart the recording mode revert to RECORD ON.
- (2) The same procedure applies to ABRT (F4 key) executed during the READ mode.

**WRITE Information (INFO)**

**Function** : Displays writing information.

**Indicating Items :**

- ①
- ②
- ③
- ④
- ⑤
- ⑥

```

Apr.01.88 00: 59
CH:12--
DATA LEN: 8000
SAMPL: 9Hz
TRIG MODE: ON
TRIG POINT: 401

```

- ① Displays the sampling start time when TRIG is OFF.  
Displays the TRIG ON time.
- ② Displays the data writing channel number. Channels with RANGE MODE OFF are shown as (-). (In the above example the 3rd and 4th channels are in this mode.)
- ③ Displays the data length actually sampled.
- ④ Displays the sampling rate set value.
- ⑤ Indicates whether the TRIG MODE is ON or OFF.  
The following TRIG is not indicated if the current TRIG is OFF.
- ⑥ Displays the trigger starting point.

**Operation** : Press F2 when the READ setting condition panel is displayed.

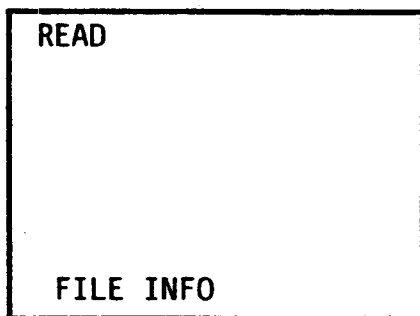

## <IC Memory Card (RD-MC256) Specifications> (Supplement)

<b>Function:</b>	Panel setting and measured data storage
<b>Medium:</b>	IC memory card
<b>Memory Capacity:</b>	256K bytes
<b>Sampling Mode:</b>	Free Mode; Manual start Trigger Mode; Starts with trigger conditions
<b>Sampling Rate:</b>	Free Mode; 135 / 9 / 5 / 3 / 1 / 0.5 / 0.2 Hz ... possible to switch common setting to each channel Trigger Mode; 9 / 5 / 3 / 1 / 0.5 / 0.2 Hz ... possible to switch common setting to each channel
<b>Data Length:</b>	1000 / 2000 / 4000 / 8000 / 16000 / 32000 data / channel, common setting for each channel, 2 bytes/data resulting in 32000 data (max) for 4-channel model.
<b>Sampling:</b>	Each selected channel data stored simultaneously (excepting RANGE OFF channel).
<b>Trigger Condition:</b>	Alarm Detection; Starts with any alarm ON (Detecting interval is 1 second) External Contact Signal; Storing begins with an external contact (ON) signal, available for optional model with /REM function. Chart End Detection; Starts with chart end.
<b>Pre-trigger:</b>	Can be set from 0 to 100%, 10% increments.
<b>Memory Data:</b>	Panel setting data Measured data Interface input data (for Model with /GP-IB or /RS232C)
<b>Output:</b>	Printout; data output rate ... 135 / 9 / 5 / 3 / 1 / 0.5 / 0.2 Hz, possible to switch Interface Output (for Model with /GP-IB or /RS232C); ASCII to BINARY output
<b>Battery:</b>	Lithium battery (lifetime approx. 3 years)

## 6.4.14 SET UP Mode

**Function** : Performs initial settings such as °C / °F selection and chart speed mm or inch selection.

**Setting Items** : The outline of functions executed in the SET UP mode is shown in the following.

Menu	Setting item	function					Details
		NE-XT	F1	F2	F3	F4	
UNIT	TEMP UNIT		°C	°F			Sets temperature setting units
	CHART SPD UNIT		mm	inch			Sets speed setting units
PRN (Not available for RD3722)	CHANGE INFO		ON	OFF			Chart speed change print out
	TIME INFO		T/M	TIME	OFF		Time print out
	ALARM INFO		ON	OFF			Alarm print out
	SCALE INFO		ON	OFF			Scale print out
	MESSAGE TIME		ON	OFF			Time print out during message print out
	TAG/CH		CH	TAG			TAG or CH selection during print out
RCD	*POC TRACE		P-P	MEAN			Pen offset compensation selection
	POC REF CH		MAX	AUTO			Reference channel select on for pen offset compensation recording
	1CH FORM & 4CH FORM		OFF	PART	ATSS		Recording format
RMT (option) (/REM)	REMOTE CNTRL		ON	OFF			Presence or absence of remote control
	CHART SPD2		ON	OFF			Presence or absence of CHART SPD 2 by remote control
	CHART CLOCK		INT	EXT			Internal, external switching of chart feed clock
COM (option)	GP-IB ADDRESS	<input type="radio"/>	0	1	2	3	GP-IB address
		<input type="radio"/>	4	5	6	7	
		<input type="radio"/>	8	9	10	11	
	RS BAUD RATES	<input type="radio"/>	12	13	14	15	RS232C, Baud rate
		<input type="radio"/>	75	150	300	600	
		<input type="radio"/>	1200	2400	4800	9600	
	RS STOP BITS		1	1.5	2		RS232C, Stop bit
RS PARITY		EVEN	ODD	NONE		RS232C, Parity error check	
RS DATA BITS		7	8			RS232C, Data bit length	
RS HANDSHAKE	<input type="radio"/> <input type="radio"/>	OFF : C:R	X:E	X:R	C:E	RS232C, Handshake	
RJC	1CH RJC & 4CH RJC		INT	EXT			RJC INTERNAL/EXTERNAL
OTHR	ALARM HYS		←	→	del		Alarm hysteresis
	MATH ERR						Data handling during calculation error
	CHART REROLL		ON	OFF			/REROL function selection
	ZERO		L	R			Zero point right / left position specification
RAM	RAM CLEAR		YES	NO			Setting information initialization

\*For the setting of RMT, refer to the end of this manual

\*For the setting of COM, refer to the separate manual (Manual Number M1432).

\* Not available for one-pen model.

**Operation** : SET-UP mode setting Turn ON the SET UP switch (Ⓣ in Section 3.1) with the recorder power turned OFF, then turn ON the recorder power while pressing the ENTRY key to set to the SET UP mode.  
After SET-UP mode has been set, and in normal operation mode, turn off the SET UP switch.  
The updated setting contents are not affected even if the setting is executed with the SET UP switch turned off.

**(1) UNIT Setting**

**Function** : Sets temperature and chart speed units.

**Setting Items** :

- ① TEMP UNIT : °C or °F
- ② CHART SPD UNIT : mm or inch

**Setting Example** :

**Note** : If the TEMP UNIT is changed, RANGE MODE is initialized.



[Key operation]

[Setting display]

[Description]

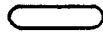
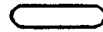
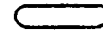
 F1	<div style="border: 1px solid black; padding: 5px;">                     SET UP                       ↓ UNIT PRN RCD RMT                      ↓ COM RJC OTHR RAM                 </div>	<p>Press the F1 key to enter the UNIT setting mode.</p>
 F2	<div style="border: 1px solid black; padding: 5px;">                     TEMP UNIT : °C                      CHART SPD UNIT : mm                        °C    °F                 </div>	<p>Press the F2 (°F) key to select the temperature unit. (Prior to shipment)</p>
 F2	<div style="border: 1px solid black; padding: 5px;">                     TEMP UNIT : °F                      CHART SPD UNIT : mm                        mm inch                 </div>	<p>Press the F2 (inch) key to determine the chart speed (mm)</p>
<div style="border: 1px solid black; padding: 2px; display: inline-block;">ENTRY</div> ( <div style="border: 1px solid black; padding: 2px; display: inline-block;">ENTRY</div> )	<div style="border: 1px solid black; padding: 5px;">                     TEMP UNIT : °F                      CHART SPD UNIT : inch                 </div>	<p>After completing the setting, press the ENTRY key. If the ENTRY key is pressed once, the display returns to the SET UP menu and, if it is pressed twice, the start-up state is returned.</p>

(2) PRN Setting (RD3721 only)

Function : Performs various digital print-out related settings.

Setting Items :

- ① CHANGE INFO : Print-out ON/OFF during chart speed change and POC selection
- ② TIME INFO : Fixed time print-out related setting.
  - T/M : Prints out time and measured value
  - TIME : Only fixed time print out.
  - OFF : No print out is made.
- ③ ALARM INFO : Alarm print-out ON/OFF
- ④ SCALE INFO : Scale print-out ON/OFF during fixed time print out and list print out.
- ⑤ MESSAGE TIME : Time print out ON/OFF during MESSAGE print out.
- ⑥ TAG/CH : TAG and CH selection of fixed time, alarm and scale print out.

Setting Example :

- ① CHANGE INFO : OFF
- ② TIME INFO : TIME
- ③ ALARM INFO : OFF
- ④ SCALE INFO : OFF
- ⑤ MESSAGE TIME : OFF
- ⑥ TAG/CH : TAG

\* For print-out, refer to Section 2.3.

## [Key operation]

## [Setting display]

## [Description]

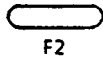

```

SET UP

↓ UNIT PRN RCD RMT
↓ COM RJC OTHR RAM

```

Press the F2 key to enter the PRN setting mode.

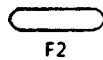

```

CHANGE INFO : ON
TIME INFO : T/M
ALARM INFO : ON
SCALE INFO : ON
MESSAGE TIME : ON
TAG/CH : CH
      ON  OFF

```

Select CHANGE INFO by pressing the F2 (OFF) key. (Set ON prior to shipment.)

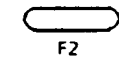

```

CHANGE INFO : OFF
TIME INFO : T/M
ALARM INFO : ON
SCALE INFO : ON
MESSAGE TIME : ON
TAG/CH : CH
      T/M TIME OFF

```

Set TIME INFO to TIME by pressing the F2 key. (Set to T/M prior to shipment.)

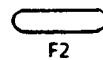

```

TIME INFO : TIME
ALARM INFO : ON
SCALE INFO : ON
MESSAGE TIME : ON
TAG/CH : CH
      ON  OFF

```

Select ALARM INFO by pressing the F2 (OFF) key. (Set ON prior to shipment.)

[Key operation]

[Setting display]

[Description]

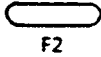

ALARM INFO : OFF  
SCALE INFO : ON  
  
ON OFF

Select SCALE INFO by pressing the F2 (OFF) key. (Set ON prior to shipment.)

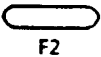

SCALE INFO : OFF  
MESSAGE TIME : ON  
  
ON OFF

Select MESSAGE TIME by pressing the F2 (OFF) key. (Set ON prior to shipment.)

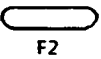

MESSAGE TIME : OFF  
TAG/CH : CH  
  
CH TAG

Select TAG/CH by pressing the F2 (TAG) key. (Set CH prior to shipment.)  
Even if TAG is selected by CH in MANUAL PRINT mode.



CHANGE INFO : OFF  
TIME INFO : TIME  
ALARM INFO : OFF  
SCAL INFO : OFF  
MESSAGE TIME : OFF  
TAG/CH : TAG

After setting is finished press the ENTRY key.  
If the ENTRY key is pressed once, the display returns to the SET UP menu and, if it is pressed twice, to the start-up state.

**(3) RCD Setting**

**Function** : Sets pen off set compensation method and recording format.

**Setting Items** :

- ① POC TRACE : Setting during pen offset compensation recording (not available for one-pen model)
- P-P : Records maximum and minimum values
- MEAN : Records the mean value.  
Mean value is that of the maximum and minimum values sampled while the chart is fed by 1 step (0.05 mm).
- \* Recording is set to MEAN recording automatically at chart speeds exceeding 180 mm/H. (poc input is not available for one-pen model)
- ② POC REF CH : Reference CH selection and setting in pen offset compensation recording mode.
- MAX : Pen offset compensation recording is performed in the maximum number CH (e.g. CH4) for 4-pen recorder) regarded as reference CH.
- AUTO : In the POC ON or chart start mode, pen offset compensation is performed in the maximum number CH among the measuring CHs (CH of which range is not set to OFF ) regarded as reference CH. During recording, even if the greater number than the reference CH number is set to the measuring CH, the CH cannot perform pen offset compensation recording.  
If the pen offset compensation recording is required, turn OFF the POC once or perform CHART STOP then retry POC recording, and the CH performs pen offset recording as a new reference CH.
- ③ 1 to CH4 FORM : Recording format
- OFF : Normal mode
- PART : Performs partially suppressed and extended recording
- ATSS : Performs AUTO Span Shift.

**Restrictions** : PART and ATSS cannot be used in the same channel. However, one of them must be selected.

**Setting Example** :

POC TRACE : MEAN

POC REF CH : AUTO

1 to CH4 FORM :

1CH : ATSS

2CH : PART

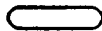
**[Key operation]****[Setting display]****[Description]**

F3

```

SET UP
+ UNIT PRN RCD RMT
+ COM RJC OTHR RAM
  
```

Press the F3 key to enter the RCD setting mode.



F2

```

POC TRACE : P-P
1CH FORM : OFF
|
4CH FORM

P-P MEAN
  
```

Select POC TRACE by pressing the F2 (MEAN) key. (Set to P-P prior to shipment.)



F2

```

POC TRACE : P-P
POC REF CH : AUTO
1CH FORM : OFF
|
4CH FORM : OFF

MAX AUTO
  
```

Select POC REF CH by pressing the F2 (AUTO) key (Set to Max prior to shipment.)



F3

```

POC TRACE : MEAN
POC REF CH : AUTO
1CH FORM : OFF
2CH FORM : OFF
|
4CH
OFF PART ATSS
  
```

CH1 select from (Set OFF prior to shipment.)

**[Key operation]****[Setting display]****[Description]**

  
F2

```

POC TRACE : MEAN
POC REFCH : AUTO
1CH FORM : ATSS
2CH FORM : OFF
|
4CH

OFF PART ATSS

```

CH2 and the succeeding channels in the same way as for CH1. (Prior to shipment it is set to OFF.)

  
ENTRY

  
ENTRY

```

POC TRACE : MEAN
POC REFCH : AUTO
1CH FORM : ATSS
2CH FORM : PART
|
4CH

OFF PART ATSS

```

After setting is finished press the ENTRY key.  
If the ENTRY key is pressed once, the display returns to the SET UP menu and, if it is pressed twice, to the start-up state.

**<Pen Offset Compensation Recording> (Supplement)**

(1) The POC reference pen selectable function is used in the following cases.

When the POC recording is performed by only two pens of CH1 and 2 on a 4 - pen model, for the current model, because the CH4 was the reference CH, the POC recording was performed in CH4 regardless of the reference.

Consequently, the trace of the CH2 lags behind the actual real - time waveform by the chart feeding time for the gap between pens of CH4 and CH2.

For the LR, with the measuring mode of each channel 3 and 4 set to OFF,

- ① When the CHART START is turned ON in the POC ON state
- ② When the POC is turned ON in the CHART STRT ON state.

the POC recording can be performed automatically in CH2.

Note)

When the POC reference CH is selectable

- ① The POC reference CH is indicated on the POC modified printing when the POC is turned ON.

△POC3 13 : 54

The POC starts in CH3 regarded as reference CH.

- ② The POC reference CH is indicated on the chart start printing at the CHART START time in POC ON status.

△1000mm/M POC 2 16 : 38

POC recording starts in CH2 regarded as a reference CH

- ③ The POC reference CH is also indicated in the fixed time printing  
60mm/M POC3

(2) When the CHART STOP is pressed during POC recording, the chart feeding continues until the pen 1 terminates recording the pen offset corresponding data and stops.

- ① When the chart speed is 200mm/M or more, the chart is fed while keeping that speed.
- ② When the chart speed is less than 200mm/M, the remaining pen offset data can be recorded at the chart speed increased up to 200mm/M. Hence, even the recording is performed at extreme low speed, the pen offset data can be swept at several seconds and the chart can be stopped.
- ③ When the chart is fed by external clock, the speed is changed to 200mm/M internally to output the pen offset data.
- ④ The pens in number 2 or greater move to stand - by positions in the order from the pen which wrote pen offset data.

When all the pens write pen offset data, the pens return to measuring data position.



**(4) RJC Setting**

internally or externally.

**Function** : Sets whether or not thermocouple range RJC (reference junction compensation) is made internal or external

**Setting Items** :

- ① CH : Channel No.
- ② INT/EXT : Internal (INT)/external (EXT) selection of reference junction compensation
- ③ Reference junction compensation voltage when EXT is selected.  
Set the value in the range of  $-20000$  to  $20000$   $\mu\text{V}$ .

**Setting Example** :

- ① CH : 1
- ② INT/EXT : EXT
- ③ Compensation voltage :  $0\mu\text{V}$

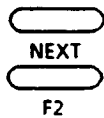
**[Key operation]****[Setting display]**

```

SET UP

+ UNIT PRN RCD RMT
+ COM RJC OTHR RAM
  
```

```

1CH RJC : INT
2CH RJC : INT
      )
4CH RJC : INT
  
```

```

INT EXT
  
```

**[Description]**

Press the NEXT and F2 key to enter the RJC setting mode.

Select RJC by pressing the F2 (EXT) key.  
(Set to INT prior to shipment.)

N O #

```

1CH RJC : EXT  ___ μV
2CH RJC : INT
  |
4CH RJC : INT

←  →  del
    
```

When set to EXT, the RJC value can be entered to the right of EXT.

Set the value in the -20000 to 20000 μV range.

When the ice point reference chamber or dewar flask (0°C) is used, input 0μV.

ENTRY

ENTRY

```

1CH RJC : EXT  0μV
2CH RJC : INT
  |
4CH RJC : INT

INT EXT
    
```

Similarly, the same setting is made up to CH4.

After setting is finished press the ENTRY key. If the ENTRY key is pressed once, the display returns to the SET UP menu and, if it is pressed twice, to the start-up state.

(5) OTHER Setting

Function : Set alarm hysteresis, processing during calculation error, select reroll function and zero point position.

Setting Items :

- ① ALARM HYS : Alarm hysteresis setting range 0 to 100%  
Hysteresis should be specified using ratio with respect to recoding span width currently set.
- ② MATH ERR : Data processing during calculation error occurrence  
UP : Processed as (+) overflow  
DOWN: Processed as (-) overflow
- ③ CHART REROLL : Chart reroll function selection. When the Optional metal fitting is attached, this should be turned ON. If not attached, be sure to turn OFF.
- ④ ZERO : Specify zero point position whether zero point is to be located on the right or left side.

Setting example :

- ① ALARM HYS : 2%
- ② MATH ERR : DOWN
- ③ CHART REROLL : ON
- ④ ZERO : LEFT

[Key operation]

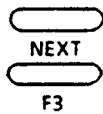

[Setting display]

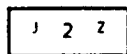
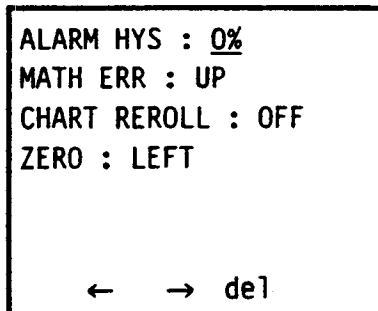
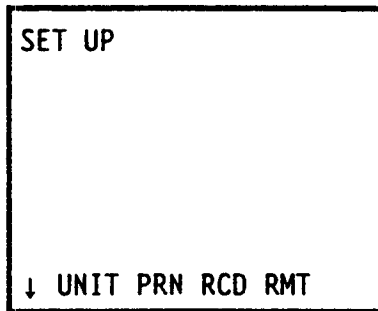

[Description]

Press the NEXT and F3 key to enter the OTHER setting mode.

Set alarm hysteresis within the 0 to 100% range.  
Set hysteresis in % with respect to span width.  
(0% set at the factory.)

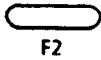

ALARM HYS : 2%  
 MATH ERR : UP  
 CHART REROLL : OFF  
 ZERO : LEFT

UP DOWN

Set MATH ERR to F2 (DOWN).  
 (Set to UP prior to shipment.)

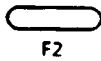

ALARM HYS : 2%  
 MATH ERR : DOWN  
 CHART REROLL : OFF  
 ZERO : LEFT

OFF ON

After setting is finished press  
 the ENTRY key.

If the ENTRY key is pressed  
 once, the display returns to the  
 SET UP menu and, if it is  
 pressed twice, to the start-up  
 state.

Set CHART REROLL to F2 (ON)  
 (Set to OFF prior to shipment.)

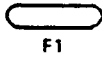

ALARM HYS : 2%  
 MATH ERR : DOWN  
 CHART REROLL : ON  
 ZERO : LEFT

L R

Set ZERO to F1 (LEFT).  
 (Set to LEFT prior to shipment.)



ALARM HYS : 2%  
 MATH ERR : DOWN  
 CHART REROLL : ON  
 ZERO : LEFT

L R

After setting is finished press  
 the ENTRY key.

If the ENTRY key is pressed  
 once, the display returns to the  
 SET UP menu and, if it is  
 pressed twice, the display returns  
 to the start-up state.

**(6) RAM CLEAR Setting**

**Function** : Returns the SET UP, range, etc. settings currently set to their initial values.

**Note** : SET-UP TEMP UPNIT and time setting are not cleared.

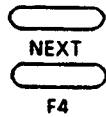
**[Key operation]****[Setting display]****[Description]**

SET UP

↓ UNIT PRN RCD RMT

↓ COM RJC OTHR RAM

Press the NEXT and F4 key to enter the RAM CLEAR setting mode.

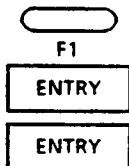

RAM CLEAR : NO

↓ YES NO

Press the F1 key when returning to the initial setting. (Set to ON prior to shipment.) To suspend the procedure at this stage, press the F2 key. If the ENTRY key is pressed once, the display returns to the SET UP menu to execute RAM CLEAR, and if the ENTRY key is pressed twice, the display returns to the start-up state.

### 6.4.15 Program Table

Table 6.6 shows the functions which can perform settings at the initial settings prior to shipment.

Table 6.6

		NE XT	F1	F2	F3	F4		
Function Selection	CH	*↓	1CH	2CH*	3CH*	4CH*		
	MODE	↓	OFF	VOLT	TC	RTD*		
		↓	DELT	SCAL	COPY	COM*		
		↓	MATH*					
	FILTER		0.1Hz	1Hz	OFF			
	TC TYPE	↓	R	S	B	K		
		↓	E	J	T	N		
		↓	W	L	U	KpvsAu7fe		
	RTD TYPE	↓	Pt1D(Pt100 : 1)	Pt2D(Pt100 : 2)	Pt3D(Pt100 : 3)	Pt4D(Pt150 : 1)		
		↓	Pt5D(Pt50 : 2)	Pl1(Pt100 : 1 / JPt)	Pl2J(Pt100 : 2 / JPt)	Pl3J(Pt100 : 3 / JPt)		
		↓	Pl4J(Pt150 : 1 / JPt)	Pl5J(50 : 2 / JPt)	Ni1D(Ni100 : 1 / DIN)	Ni1S(Ni100 : 1 / SANA)		
		↓	J263*B					
	Sub mode		VOLT	TC	RTD*	COM*		
	MOVE SPAN		L	R	L & R	Srch		
	RECORD AREA ADJUST		L	R				
	AUX	↓	ALM	TAG*	RCD	MSG*		
		↓	CLK	RAM				
	ALM		H	L	OFF			
	ALM(RLY)	↓	OFF	1	2	3		
		↓	4					
		↓						
	Recording format		ON	OFF				
	SPAN SCALE, etc		←	→	del			
	SCALE mode span		←	→	del	meas		
Unit, etc.	↓	←	→	del				
	↓	Ω	μ	%	&			
Chart speed		←	→	mm / H	mm / M			
Setting knob Selection	Chart speed mm / min mm / h	10	12	20	30	50	60	75
		100	120	150	200	300	500	600
		750	1000	1200				
	Chart speed inch / min inch / h	0.5	1	1.2	2	3	5	6
		10	12	20	30	45		
	Range high-sensitivity	100μV	200μV	500μV	1mV	2mV	5mV	10mV
		20mV	50mV	100mV	200mV	500mV	1V	2V
		5V	10V	20V	50V	100V	200V	
	Range medium-sensitivity	1mV	2mV	5mV	10mV	20mV	50mV	100mV
		200mV	500mV	1V	2V	5V	10V	20V
		50V	100V	200V				
	Range low-sensitivity	10mV	20mV	50mV	100mV	200mV	500mV	1V
2V		5V	10V	20V	50V	100V	200V	

\* Depending on Model name (No. of pens) and options these functions may not be provided.

### 6.4.16 Error Message

Incorrect operation panel key operation causes an error message to be displayed.

The details of incorrect settings can be read from the numerics next to the error display. Therefore, re-set in this case.

Error No.	Details
1	Grammar incorrect
2	The entered value exceeds the specified range or it is a value which cannot be set.
3	CH No. unsettingtable.
4	The entered constant exceeds the specified range or it is a value which cannot be set.
5	Character unsettingtable.
7	The entered mode type is not appropriate.
9	An unsettingtable range is selected.
10	The equation setting is inappropriate.
12	The set value is out of the settingtable range or is incorrect.
13	The set value is out of the settingtable range or is incorrect.
26	The RJC value is out of 20000 in the SET UP mode and at RJC EXT.
27	The ALARM HYS set-value exceeds 0 to 100% in the SET UP mode and at RTC OTHER.
31	IC memory card error <ul style="list-style-type: none"> <li>◦ No memory card is inserted.</li> <li>◦ Format error (not initialized)</li> <li>◦ Error detected in file control area data</li> <li>→ Pull out the card and reinstall it</li> <li>→ Initialize the card</li> </ul>
32	Capacity error <ul style="list-style-type: none"> <li>◦ Insufficient card memory capacity (no free area)</li> <li>◦ Sampling is attempted using 8KB card</li> <li>→ Delete unrequired card</li> <li>→ Reduce sampling length / number of sampling CH<sub>S</sub></li> <li>→ Use 256 KB Card (error in sampling)</li> </ul>
33	File name error <ul style="list-style-type: none"> <li>◦ NO VOLUME / FILE Name input (or all spaces)</li> <li>→ Enter VOLUME / FILE Name correctly</li> </ul>
34	Sample / Readout BUSY <ul style="list-style-type: none"> <li>◦ During Sampling / Readout, attempt to execute Sampling / Readout is made</li> <li>→ Wait the end of current Sampling / Readout or break the Sampling / Readout using ABORT and retry it.</li> </ul>
35	Directory Error <ul style="list-style-type: none"> <li>◦ New file cannot be registered in the directory (up to 47 files)</li> <li>→ Use separate card or delete unrequired file</li> </ul>
36	(Deletion inhibited File) <ul style="list-style-type: none"> <li>*◦ Attempt to delete deletion inhibited file. The file created in a personal computer which does not support in RD3721/RD3722 specifies deletion inhibited (write inhibited) file, or attempt to delete subdirectory system file is made.</li> </ul>
37	Turns all triggers OFF in trigger mode

Error No.	Details	
38	Start data position error	<ul style="list-style-type: none"> <li>◦ Readout start data number exceeding the actual number of sampled data is used.</li> </ul>
41	Number of sample CH <sub>5</sub> error	<ul style="list-style-type: none"> <li>◦ Sampling is attempted with all CH measurements set to OFF.</li> </ul>
42	TOO LONG data length	<ul style="list-style-type: none"> <li>◦ *Readout data length exceeds 32000 points (When sampled data is read out by other measuring instruments)</li> </ul>
43	Format ILLEGAL	<ul style="list-style-type: none"> <li>◦ *The format of the memory card sampled data file is not supporting objective.</li> </ul>
44	No Sample data	<ul style="list-style-type: none"> <li>◦ *Data readout cannot be executed because the number of actual sampled data is 0.</li> </ul>
45	Setting file error  *Error  When sampling is performed using the recorder and the sample data file is readout by the recorder, no error occurs. This error occurs when the sampled data is read out using other measuring instruments.	<ul style="list-style-type: none"> <li>◦ *When set point is LOAD               <ol style="list-style-type: none"> <li>1) Excessive large file size</li> <li>2) Error is detected in file header information</li> </ol> </li> </ul>



## 7. MAINTENANCE

### 7.1 Fuse Replacement

It is recommended that the fuse be replaced every 2 years as part of preventative maintenance.

- (1) The fuse holder is at the top of the power connector on the left side panel. (Fig. 7.1)
- (2) Insert a screwdriver into the top of the fuse holder then pull it forward to remove the fuse holder.  
The fuse holder can house 2 fuses; the fuse in service and a spare fuse. (Fig. 7.2)
- (3) Replace the fuse in service with a new or spare fuse.  
Fuse in service: 2 A time lag type  
Part No. A9134KF
- (4) Return the fuse holder to its original position to complete fuse replacement.

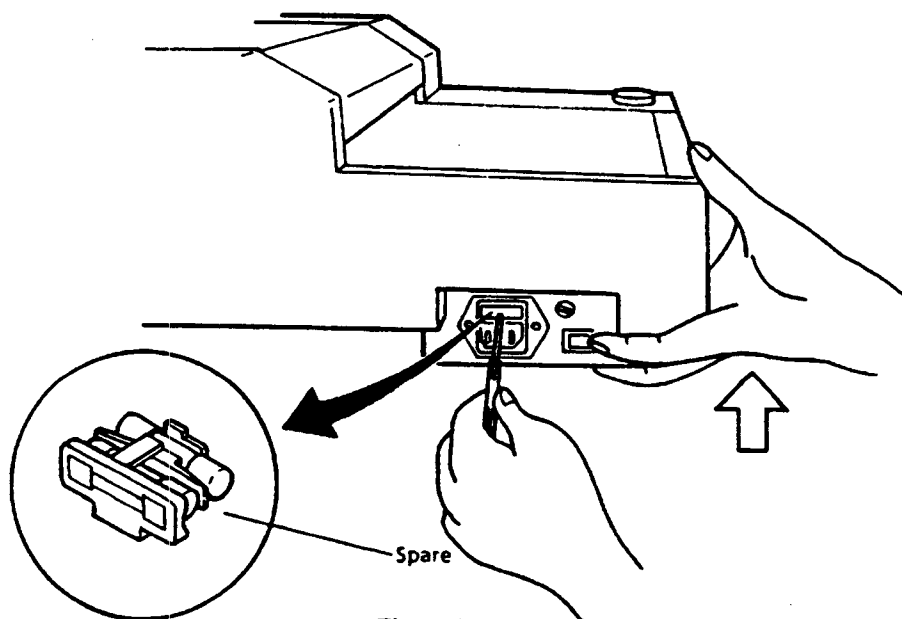

Figure 7.1

## **7.2 Cleaning**

When cleaning the RD3721/RD3722 panel, wipe off dust using a soft cloth. Never attempt to clean the panel with thinner or alcohol.

# 8. Specifications

## MEASUREMENTS

**Drive System:** Automatic null-balancing digital servo mechanism with brushless DC servomotor.

**Type of Input:** Floating, guarded and shielded (No guard on 10 mV F.S. model).

**Input Types & Measuring Ranges:** DC V... 10 mV to 200V F.S., 1 mV to 200 V F.S., or 0.1 mV to 200 V F.S.

TC (ANSI, DIN, JIS)...Type R, S, B, K, E, J, T, N, W, L (DIN), U (DIN).

TC (NBS)...KP vs Au7Fe (4 to 280K).

RTD (DIN, JIS or SAMA)...Pt 100  $\Omega$  (1 mA), Pt 50  $\Omega$  (1 mA), Ni 100  $\Omega$ .

RTD...Pt 100 (1 mA), JPt 100 (1 mA), Pt 50 (1 mA), Ni 100 (1 mA)

**Accuracy:** DC V...  $\pm (0.05\% \text{ of rdg} + 0.03\% \text{ of range} + 0.5 \mu\text{V})$ .

TC...  $\pm (0.05\% \text{ of rdg} + 0.5^\circ\text{C})$  for K, E, J, T, L, U and KP vs Au7Fe.  $\pm (0.05\% \text{ of rdg} + 1^\circ\text{C})$  for R, S and B.  $\pm (0.1\% \text{ of rdg} + 0.5^\circ\text{C})$  for N.  $\pm (0.1\% \text{ of rdg} + 1^\circ\text{C})$  for W.

RTD...  $\pm (0.05\% \text{ of rdg} + 0.2^\circ\text{C})$  for Pt 100 $\Omega$  and Ni 100  $\Omega$ .  $\pm (0.05\% \text{ of rdg} + 0.3^\circ\text{C})$  for Pt 50  $\Omega$

### Reference Junction Compensating Accuracy (TC):

$\pm 0.5^\circ\text{C}$  for K, E, J, T, N, W, L, U and KP vs Au7Fe,  $\pm 1^\circ\text{C}$  for R, S and B (measuring range of down to  $-100^\circ\text{C}$ ).

**Bias Current:** 4 nA.

**Filter:** 0.1, 1 Hz or OFF (selectable).

**Zero Set:** Adjustable.

**Measuring Cycle:** 135 Hz.

**Pen Offset Compensation (Standard):** Average, max./min. recording selectable (with compensation ON/OFF switch), resolution on time axis... 0.05 mm, automatic sweep function for pen offset data selectable POC (Pen Offset Compensation) reference pen.

**Input Impedance:** Approx. 1 M $\Omega$  (DC V & TC).

**Allowable Source Resistance:** Less than 1 k $\Omega$  (DC V & TC).

**Temperature Coefficient:** Zero drift...  $0.05 \mu\text{V}/^\circ\text{C} + 0.01\%$  of range/ $^\circ\text{C}$ , F.S....  $0.01\%$  of range/ $^\circ\text{C}$ .

**Maximum Allowable Input Voltage:** 250 V DC.

**Maximum Common Mode Voltage:** 250 Vrms AC.

**Common Mode Rejection:** More than 150 dB at AC.

**Normal Mode Rejection:** More than 50 dB at 50 or 60 Hz.

## RECORDING & PRINTING

**Writing System:** Ink writing using disposable felt-tip pen cartridges (analog data).

**Printing System:** Wire-dot printer using ribbon cassette (digital data).

**Effective Recording Span:** 250 mm (analog data).

**Pen Offset between Channels:** Approx. 4 mm on the time axis.

**Number of Channels:** 1, 2, 3 or 4.

**Recording Colors:** 1st pen...red, 2nd pen...green, 3rd pen...blue, 4th pen...brown.

**Recording Accuracy:** Measurement accuracy +  $\pm 0.2\%$  of effective recording span (including non-linearity, dead-band and error between ranges).

**Maximum Pen Speed:** Approx. 1,600 mm/s.

**Maximum Pen Acceleration:** Approx. 8G.

**Printing Rate:** Approx. 1.5 s/line.

**Chart:** Z-fold chart (270 mm  $\times$  20 m), Roll chart (270 mm  $\times$  20 m)...optional.

**Chart Speeds:** 10 to 1,200 mm/min & mm/h (1 mm steps), and 0.5 to 45.0 inch/min & inch/h (0.1 inch steps).

**Change of Chart Speed:** Changes chart speed with remote control signals (optional).

**RECORD ON/OFF Selectors:** Independently provided for each channel on the front panel (ON...measurement/recording, OFF...measurement)

**Pen Lift:** All pens are simultaneously lifted and lowered.

**Chart Drive:** Pulse motor drive.

**Chart Speed Accuracy:**  $\pm 0.1\%$  (at recording of longer than 1 m).

**Digital Data Printout:** Time, chart speed, channel number (tag number), measured data and engineering unit are printed out at the following intervals:

Chart speed		Printing intervals
mm/min	mm/h	
1,200 to 300	—	1 min
299 to 30	—	10 min
29 to 10	1,200 to 120	1 h
—	199 to 60	2 h
—	59 to 40	3 h
—	39 to 20	6 h
—	19 to 10	12 h

**Tag Number Printout:** Tag number can be printed out in place of channel number (up to 7 alphanumeric).

**Alarm Printout:** Channel number, alarm type, and the time of alarm ON/OFF are printed.

**Scale Markings Printout:** 0% and 100% scale values can be printed out at the same interval as digital printout.

**Program List Printout:** Contents of entire setting memory can be listed on the chart.

**Manual Printout:** Time and measured data for all channels can be printed out in a single line by a push of MANUAL PRINT key.

**Message Printout:** Message of up to 70 characters can be printed at a push of MANUAL MESSAGE key (Message 0), or by external contact signal (Message 1 to 4; optional, up to 4 channels).

**Change of Chart Speed Printout:** Chart speed and time can be printed out at the change of chart speed.

**Pen Offset Compensation ON/OFF Printout:** ON, OFF mark and time can be printed out.

**Change of Range Printout:** Changed contents and time can be printed at the change of range (on Auto span shift mode).

**Partially Expanded-Scale Recording:** Any portion within full scale can be expanded or reduced for each channel.

**Auto Span Shift Mode:** Automatically shifts to  $\pm 50\%$  of span, and recording continues when the input exceeds the measuring span.

**External Input Span:** Small error of external converter can be corrected by setting the span with actual input voltage (zero...span left, full...span right).

\*Note: RD3721 only.

## DISPLAY

**Type of Display:** Vacuum fluorescent display (5 x 7 dot matrix, blue), 20 characters for each channel.

**Display Modes:** 3 display modes can be selected at a push of DISPLAY SELECT key. Digital data display... Measured data (7 digits), date and time, or chart speed. Bar graph display (2.5% resolution). Range data display.

## ALARMS

**Number of Alarm Set Levels:** Up to 2 levels/channel.

**Alarm Types:** High(H), low(L), delta high(dH), and delta low(dL).

**Alarm Outputs (Optional):** Up to 4 points (internal, contact rating... 24 V DC and AC 1A).

## COMPUTING FUNCTIONS

**Standard Functions:** Scaling (ranges... -22000 to +22000), and delta T.

**Optional Mathematical Functions:** +, -, x,  $\div$ , square root, absolute value, logarithm, exponential function (up to 4 channels).

## GENERAL SPECIFICATIONS

**Standard Memory Card:** For storing the setting data (memory capacity of 8K bytes), standard accessory... lithium battery, 1 pc. (battery life of about 5 years).

**Battery-Backup Memory:** Maintains all setting for about 10 years (at room temperature) when power is removed.

**Chart END Alarm:** Automatic pen lift (RD3721 only) at out-of-chart condition (alarm output, optional).

**Mounting:** Horizontal (may be inclined up to  $10^\circ$  from horizontal)

**Operating Temperature Range:** 0 to 40°C (32 to 104°F).

**Humidity Range:** 30 to 80% relative humidity.

**Insulation Resistance:** More than 100 M $\Omega$  at 500 V DC between power line and case, and between input terminals and case.

**Dielectric Strength:** 1,500 V AC for one minute between power line and case, and between input terminals and case.

**Power Requirements:** 90 to 250 V AC, for both 50 and 60 Hz.

**Power Consumption:** 1 channel model... 85 VA max., 45 VA balanced, 2 channel model... 100 VA max., 50 VA balanced, 3 channel model... 115 VA max., 55 VA balanced, 4 channel model... 130 VA max., 60 VA balanced.

**Dimensions:** Approx. 185(H) x 448(W) x 455(D)mm, (7 - 1/4 x 17 - 5/8 x 17 - 7/8").

## Weight (Approx.):

Model	1-channel	2-channel	3-channel	4-channel
RD3721	12.5kg(27.6lbs)	13kg(28.7lbs)	13.5kg(29.8lbs)	14kg(30.9lbs)
RD3722	11.5kg(25.4lbs)	12kg(26.5lbs)	12.5kg(27.6lbs)	13kg(28.7lbs)

## OPTIONAL FEATURES

### ■ GPIB INTERFACE (/GP-IB)

**Functional, Electrical and Mechanical Specifications:**

Meets the IEEE Standard 488-1978

**Talker Functions:** Input of measured data (ASCII), output of measured data (ASCII and binary), input/output of setting data (ASCII), output of memory data (ASCII and binary).

**Listener Functions:** Controls except for power ON/OFF key lock ON/OFF and chart drive.

### ■ RS-232C INTERFACE (/RS232C)

**Functional, Electrical and Mechanical Specifications:**

Meets the EIA RS-232C.

**Controller Interface Functions:** Input of measured data (ASCII), output of measured data (ASCII and binary), input/output of setting data (ASCII), output of memory data (ASCII and binary).

**Data Transfer Rates:** 75, 150, 300, 600, 1,200, 2,400, 4,800, 9,600 bps.

### ■ REMOTE CONTROLS (/REM)

**Remote Control Signals:** External contact, open collector or TTL-level signal.

**Chart Drive Control:** Start... L logic level or closed contact. Stop... H logic level or open contact.

**Change of Chart Speed:** Chart speed 2... L logic level or closed contact. Chart speed 1... H logic level or open contact.

**Manual Printout\*:** Printout date & time and measured data ... L logic level or closed contact.

**Chart Speed:**

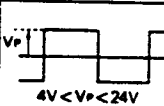
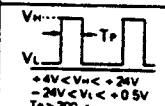
Remote control signal waveforms	Sine, triangular, rectangular waves	Pulse train
Signal level		
Max. signal source impedance	600 $\Omega$	50 $\Omega$
Chart speed	0.151 cm/min (f... Hz or PPS)	
Max. frequency	800 Hz	800 PPS

**Message Printout\*:** Start... L logic level or closed contact.

**Pen Lift\*:** All recording pens lowered... L logic level or closed contact, all recording pens lifted... H logic level or open contact.

**RECORD ON/OFF Selection:** OFF (measurement)... L logic level or closed contact. OFF (measurement/recording)... H logic level or open contact.

**External Trigger:** Data memory (RD-MC256) write... L logic level or closed contact.

\*Note: RD3721 only.

### ■ ALARMS (/AK-04)

**Number of Outputs:** 4 points (internal).

**Contact Rating:** 24 V DC and AC 1A.

**Outputs:** Alarm, FAIL alarm and chart END alarm outputs.

**■ ROLL CHART DRIVE (/ROL)**

Both Z-fold and roll chart can be used. (Roll chart must be ordered).

**■ CHART REROLL (/REROL)**

Remote control of roll chart drive by external signal (contact, open collector or TTL-level signal), or by depressing front-panel keys (Chart drive unit... standard, Roll chart... optional).

**OPTIONAL ACCESSORY****■ MEMORY CARD (RD-MC256)**

**Function:** Setting & measured data memory

**Data Format:** MS-DOS.

**Sampling Rate:** Free mode (manual start)...135, 9, 5, 3, 1, 0.5, 0.2 Hz, trigger mode (starts by trigger conditions)... 9, 5, 3, 1, 0.5, 0.2 Hz

**Memory Capacity:** 256K bytes.

**Data Length:** 1,000, 2,000, 4,000, 8,000, 16,000, 32,000 data/channel (common setting to each channel, 2 bytes/data).

**Trigger Condition:** Alarm detection, CHART END or external contact input (optional).

**Pre-Triger:** 0 to 100% (10% steps).

**Memory Data:** Measured data, interface input data and computed data.

**Output:** Interface and recording output.

**Standard Accessory:** Lithium battery... 1 pc. (battery life of about 3 years).

**This Page is Intentionally Blank**

## 9. ADJUSTMENT

### CAUTION

1. The following adjustment procedures are for service technicians that have received professional training. If the adjustments are made by the user these adjustment procedures must be thoroughly read and followed carefully.
2. Adjustment data are stored in a non - volatile memory, however note that if the memory is handled carelessly, the data may be erased.

### 9.1 Span Adjustment

- Adjust the span when the MAIN CPU BOARD ASS'Y is replaced or pen zero span is incorrect.

#### 1. Procedures

- (1) Using a ruler, mark the chart at a point 250.0mm from the 0% position which is regarded as the standard point.
- (2) Install the chart
- (3) Perform the following key operations and set each pen absolute value (each pen must be installed securely).

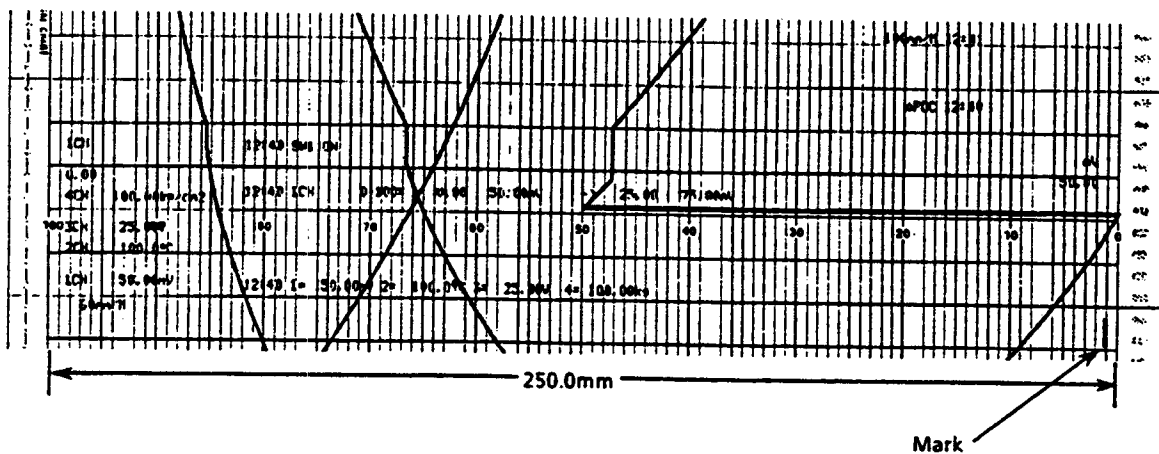

[Key operation]

[Setting display]

[Description]

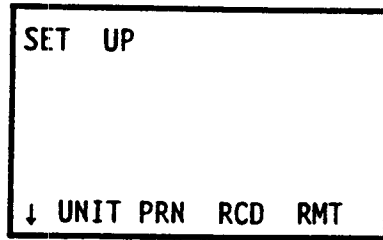
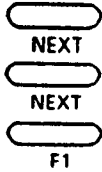

While pressing **AUX** set up the power supply. Press **NEXT** twice and select **F1** ADJ.

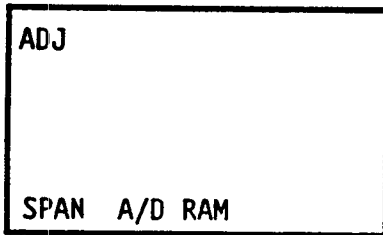
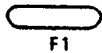

Select **F1** SPAN.

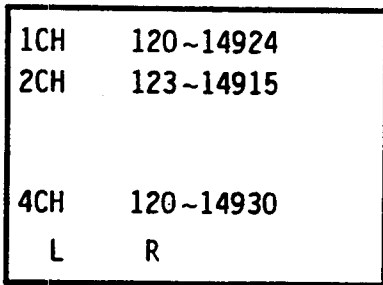
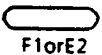

Specify L position (0% side) or R position (100% side) by selecting **F1** or **F2** Adjust (0 to 16,000) with the setting knob. When the corresponding channel adjustment is complete, specify the next CH using the cursor keys  $\nabla$  and  $\Delta$ .

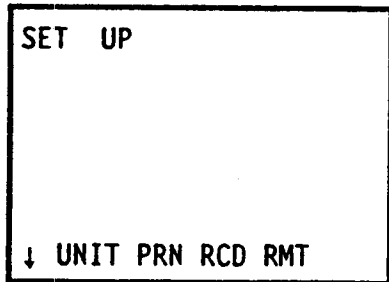

When setting is complete, press **ENTRY** to store the measurement data in the non-volatile memory. Press **ENTRY** once, the panel returns to the SET UP menu; press again and the panel returns to the startup status.

**2. Adjustment Instructions**

- ① Adjustments should be made while observing chart expansion or contraction and confirming the correct position of the RIGHT side SPAN using a correct jig such as a glass scale.
- ② Care must be taken not to cause an error by erroneous pen installation.



\*1. For the LEFT side SPAN, the 0% mark on the chart can be regarded as standard as chart expansion and contraction can be ignored.

- ③ When the LEFT side SPAN is adjusted, turn each pen RECORD switch OFF, and confirm that each pen runs on the left side block and the pen tip is off the chart.

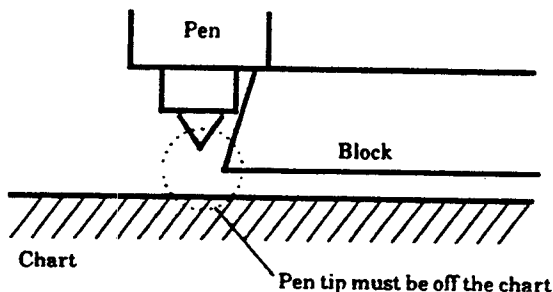

## 9.2 A / D Accuracy Adjustment

### (1) General recorder

The accuracy adjustment for the  $\Delta$  employs a method to store the measurement errors in the non - volatile memory located in the input module and performs measurement compensation in place of using a method with a potentiometer.

### (2) Adjustment Environment

To ensure standard traceability and mainframe specifications, the accuracy adjustment should be performed in thermally stabilized conditions as follows:

$$23^{\circ}\text{C} \pm 5^{\circ}\text{C}, 55 \pm 10\% \text{ R.H.}$$

For high - or medium - sensitivity specifications, zero point shift due to air-conditioning equipment or abrupt temperature changes cannot be ignored. therefore an appropriate air screen should be used.

### (3) Standards

The standards used for instrument calibration or inspection must be satisfy the following specifications. The operating conditions are :

$$23^{\circ}\text{C} \pm 5^{\circ}\text{C}, 55 \pm 100\% \text{ R.H.}$$

FUNCTION	OUTPUT	ACCURACY	FUNCTION	OUTPUT	ACCURACY
DC V	$\pm 20\text{V}$	$\pm 0.006\%$	RTD	$40\ \Omega$	$\pm 5\text{m}\ \Omega$
	$\pm 2\text{V}$			$160\ \Omega$	
	$\pm 1\text{V}$			$100\ \Omega$	
	$\pm 500\text{mV}$				
	$\pm 200\text{mV}$				
	$\pm 100\text{mV}$				
	$\pm 50\text{mV}$				
	$\pm 20\text{mV}$				
	$0\text{mV}$	$\pm 0.1\ \mu\text{V}$			

(4) Warm up the instrument for at least one hour prior to adjusting the instrument.

(5) A/D Calibration

For A/D conversion, each full scale value is converted as follows:

LEFT side (-) - 24,000 counts

RIGHT side (+) + 48,000 counts

To check that this conversion is performed correctly,

- ① Complete a zero adjustment
- ② Check number of counts (error) of each  $\pm$  full span.

The operating procedure is as follows :

[Key operation]

[Setting display]

[Description]

NEXT  
NEXT  
F1

SET UP  
  
↓ UNIT PRN RCD RMT

While pressing **AUX**, set up the power supply.  
Press **NEXT** twice and select **F1** ADJ.

↓ COM RJC OTHR RAM  
↓ ADJ

F2

ADJ  
  
SPAN A/D RAM

Select **F2** A/D  
Here Specify changed INPUT UNIT ASS'Y CH. NO. and make a zero adjustment.

F1~4

1CH  
ID : 2  
20V : -28  
  
100mV : -14  
1CH 2CH 3CH 4CH

See the next page for setting item details.

If the calibration data satisfies the following standard values :

- $\pm$  1000 or less at zero calibration and RIGHT side calibration.
- However, the accuracies can only be regarded as normal on  $\pm$  2000 in the 100  $\mu$ V range.

ENTRY  
( ENTRY )

SET UP  
  
↓ UNIT PRN RCD RMT

Press **ENTRY** once to return the panel to the SET UP menu when setting is completed.

Press again, the panel returns to the starting status.

• For A/D calibration, the setting items on the panel are as follows:

However, in the field, only ZERO calibration should be performed if necessary but other items must not be changed.

Panel display	Function Display				Sensitivity			Operating procedure & others	
		F1	F2	F3	F4	High	Medium		Low
CH	↓	1CH	2CH	3CH	4CH				
		ID	←	→	del				Enter ID code. 0: High-sensitivity RTD provided (B9619PX). 1: Medium-sensitivity RTD provided (B9619PV). 2: Low-sensitivity RTD provided (B9619PT). 3: High-sensitivity RTD not provided (B9619PW). 4: Medium-sensitivity RTD not provided (B9619PU). 5: Low-sensitivity RTD not provided (B9619PS).
20V : 2V : 1V : 500mV : 200mV : 100mV : 50mV : 20mV : 10mV : 200mV : 20mV :		- - - - - - - - - - -	+ + + + + + + + + + +			○ ○ ○ ○ ○ ○ ○ ○ ○ ○ ○	○ ○ ○ ○ ○ ○ ○ ○ ○ ○ ○	○ ○ ○ ○ ○ ○ ○ ○ ○ ○ ○	Calibration of A/D (Voltage range) Enter voltage which is now displayed.  Example (calibration of 10 mV) ⊕ Enter - 10 mV and press <u>F1</u> . ⊕ Enter + 10 mV and press <u>F2</u> + then move to any item.  Adjustment of internal attenuator
100μV (Z): 200μV (Z): 1mV (Z): 10mV (Z):		ZERO ZERO ZERO ZERO				○ ○ ○ ○	○ ○	○	Calibration of A/D (ZERO adjustment) performs ZERO adjustment Enter 0 V and press <u>F1</u> ZERO.
RTD:		40Ω	160Ω						Calibration of A/D (only when RTD range is provided.) ⊕ Connect resistance of 40 and press <u>F1</u> 40Ω ⊕ Connect resistance of 160 and press <u>F2</u> 160Ω
RTD:(Z)		100Ω							Calibration of A/D (only when RTD range is provided) Connect resistance of 100Ω and press <u>F1</u> 100Ω

**(6) Instructions for Connections etc. when Calibrating the Instrument**

When calibrating the instrument, the instrument and the standards to be used must be carefully connected so that they are in a very stable condition.

Take special care when two or more channels are calibrated concurrently, as interference may easily occur between the two instruments. Therefore, connect the instrument as follows (for voltage input).

- **LR: Independent GUARD** (Guard transfer switch must be positioned at center). However, all guard terminals between channels may be connected.

Use a twisted copper wire (not plated) and connect each channel separately (50 cm or more).

However, Input voltage may be applied to all channels simultaneously.

- **DC voltage standard: Using independent GUARD, connect to the recorder.**
- **Precision Digital Multimeter: Using LO - GUARD, connect to the recorder.**

Before A/D calibration, perform zero adjustment.

For RTD calibration, do not forget to operate the selector switch of the input module G / B terminals.

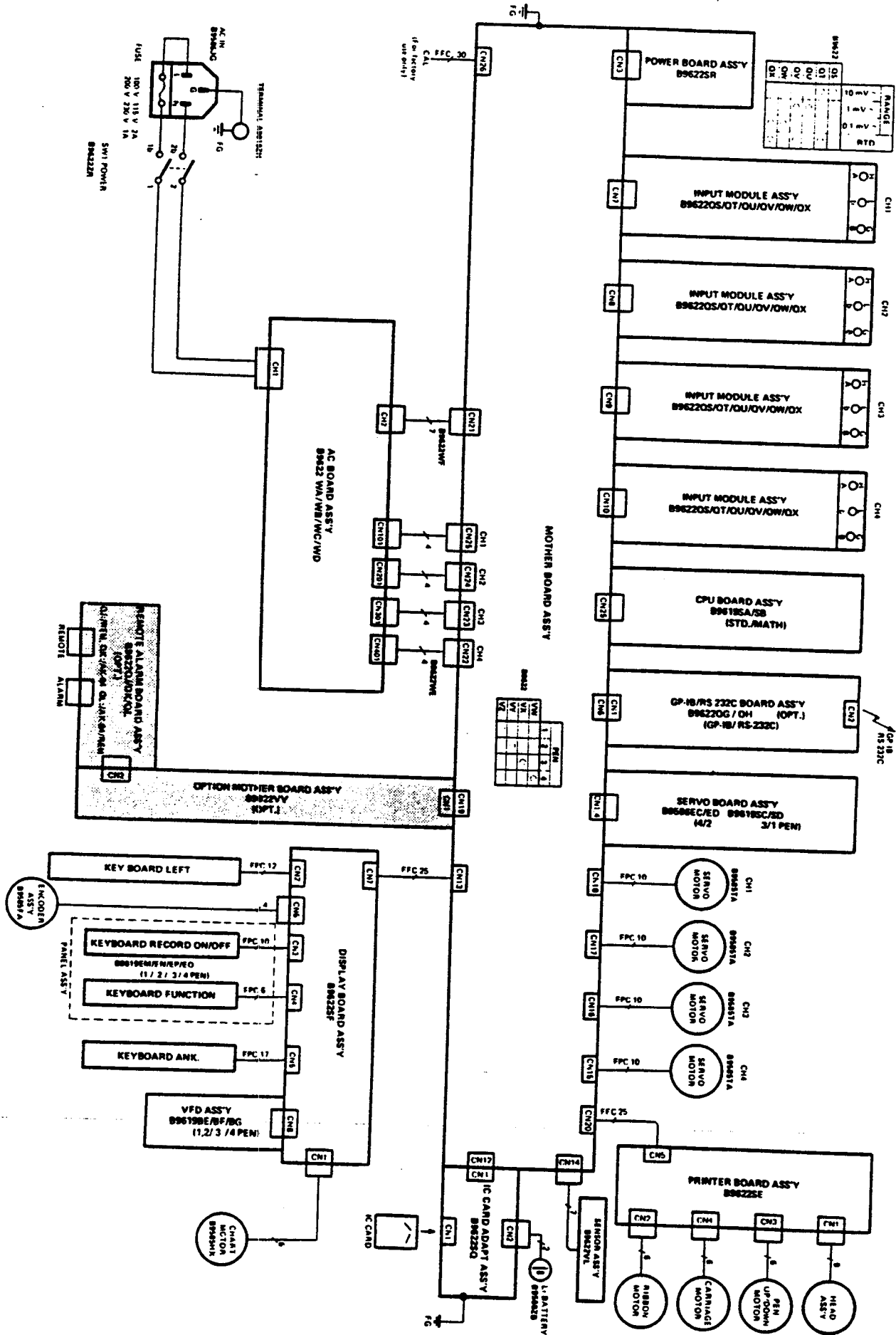

Figure 10-1. RD3721/RD3722 Series Recorder Overall Wiring

**This Page is Intentionally Blank.**

## WARRANTY/DISCLAIMER

OMEGA ENGINEERING, INC. warrants this unit to be free of defects in materials and workmanship for a period of **13 months** from date of purchase. OMEGA Warranty adds an additional one (1) month grace period to the normal **one (1) year product warranty** to cover handling and shipping time. This ensures that OMEGA's customers receive maximum coverage on each product.

If the unit should malfunction, it must be returned to the factory for evaluation. OMEGA's Customer Service Department will issue an Authorized Return (AR) number immediately upon phone or written request. Upon examination by OMEGA, if the unit is found to be defective it will be repaired or replaced at no charge. OMEGA's WARRANTY does not apply to defects resulting from any action of the purchaser, including but not limited to mishandling, improper interfacing, operation outside of design limits, improper repair, or unauthorized modification. This WARRANTY is VOID if the unit shows evidence of having been tampered with or shows evidence of being damaged as a result of excessive corrosion; or current, heat, moisture or vibration; improper specification; misapplication; misuse or other operating conditions outside of OMEGA's control. Components which wear are not warranted, including but not limited to contact points, fuses, and triacs.

**OMEGA is pleased to offer suggestions on the use of its various products. However, OMEGA neither assumes responsibility for any omissions or errors nor assumes liability for any damages that result from the use of its products in accordance with information provided by OMEGA, either verbal or written. OMEGA warrants only that the parts manufactured by it will be as specified and free of defects. OMEGA MAKES NO OTHER WARRANTIES OR REPRESENTATIONS OF ANY KIND WHATSOEVER, EXPRESSED OR IMPLIED, EXCEPT THAT OF TITLE, AND ALL IMPLIED WARRANTIES INCLUDING ANY WARRANTY OF MERCHANTABILITY AND FITNESS FOR A PARTICULAR PURPOSE ARE HEREBY DISCLAIMED. LIMITATION OF LIABILITY: The remedies of purchaser set forth herein are exclusive and the total liability of OMEGA with respect to this order, whether based on contract, warranty, negligence, indemnification, strict liability or otherwise, shall not exceed the purchase price of the component upon which liability is based. In no event shall OMEGA be liable for consequential, incidental or special damages.**

CONDITIONS: Equipment sold by OMEGA is not intended to be used, nor shall it be used: (1) as a "Basic Component" under 10 CFR 21 (NRC), used in or with any nuclear installation or activity; or (2) in medical applications or used on humans. Should any Product(s) be used in or with any nuclear installation or activity, medical application, used on humans, or misused in any way, OMEGA assumes no responsibility as set forth in our basic WARRANTY/DISCLAIMER language, and additionally, purchaser will indemnify OMEGA and hold OMEGA harmless from any liability or damage whatsoever arising out of the use of the Product(s) in such a manner.

## RETURN REQUESTS / INQUIRIES

Direct all warranty and repair requests/inquiries to the OMEGA Customer Service Department. BEFORE RETURNING ANY PRODUCT(S) TO OMEGA, PURCHASER MUST OBTAIN AN AUTHORIZED RETURN (AR) NUMBER FROM OMEGA'S CUSTOMER SERVICE DEPARTMENT (IN ORDER TO AVOID PROCESSING DELAYS). The assigned AR number should then be marked on the outside of the return package and on any correspondence.

The purchaser is responsible for shipping charges, freight, insurance and proper packaging to prevent breakage in transit.

FOR **WARRANTY** RETURNS, please have the following information available BEFORE contacting OMEGA:

1. P.O. number under which the product was PURCHASED,
2. Model and serial number of the product under warranty, and
3. Repair instructions and/or specific problems relative to the product.

FOR **NON-WARRANTY** REPAIRS, consult OMEGA for current repair charges. Have the following information available BEFORE contacting OMEGA:

1. P.O. number to cover the COST of the repair,
2. Model and serial number of product, and
3. Repair instructions and/or specific problems relative to the product.

OMEGA's policy is to make running changes, not model changes, whenever an improvement is possible. This affords our customers the latest in technology and engineering.

OMEGA is a registered trademark of OMEGA ENGINEERING, INC.

© Copyright 1996 OMEGA ENGINEERING, INC. All rights reserved. This document may not be copied, photocopied, reproduced, translated, or reduced to any electronic medium or machine-readable form, in whole or in part, without prior written consent of OMEGA ENGINEERING, INC.

# Where Do I Find Everything I Need for Process Measurement and Control? OMEGA...Of Course!

## **TEMPERATURE**

- Thermocouple, RTD & Thermistor Probes, Connectors, Panels & Assemblies
- Wire: Thermocouple, RTD & Thermistor
- Calibrators & Ice Point References
- Recorders, Controllers & Process Monitors
- Infrared Pyrometers

## **PRESSURE, STRAIN AND FORCE**

- Transducers & Strain Gauges
- Load Cells & Pressure Gauges
- Displacement Transducers
- Instrumentation & Accessories

## **FLOW/LEVEL**

- Rotameters, Gas Mass Flowmeters & Flow Computers
- Air Velocity Indicators
- Turbine/Paddlewheel Systems
- Totalizers & Batch Controllers

## **pH/CONDUCTIVITY**

- pH Electrodes, Testers & Accessories
- Benchtop/Laboratory Meters
- Controllers, Calibrators, Simulators & Pumps
- Industrial pH & Conductivity Equipment

## **DATA ACQUISITION**

- Data Acquisition & Engineering Software
- Communications-Based Acquisition Systems
- Plug-in Cards for Apple, IBM & Compatibles
- Datalogging Systems
- Recorders, Printers & Plotters

## **HEATERS**

- Heating Cable
- Cartridge & Strip Heaters
- Immersion & Band Heaters
- Flexible Heaters
- Laboratory Heaters

## **ENVIRONMENTAL MONITORING AND CONTROL**

- Metering & Control Instrumentation
- Refractometers
- Pumps & Tubing
- Air, Soil & Water Monitors
- Industrial Water & Wastewater Treatment
- pH, Conductivity & Dissolved Oxygen Instruments