

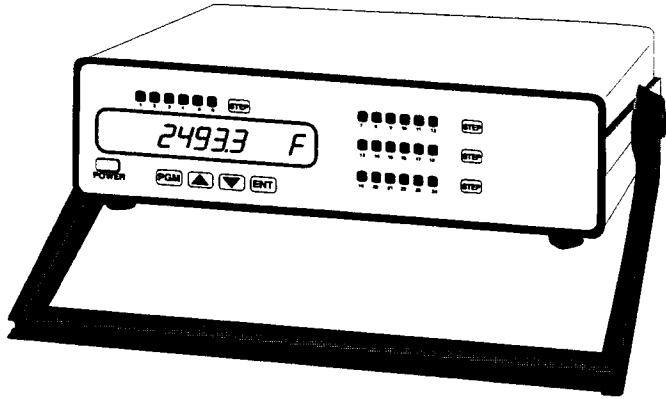

DP85 and DP86



Digital Panel Indicators



DP86 shown



Operator's Manual



Servicing USA and Canada: Call OMEGA Toll Free

USA

One Omega Drive, Box 4047
Stamford, CT 06907-0047
Telephone: (203) 359-1660
FAX: (203) 359-7700

Canada

976 Bergar
Laval (Quebec) H7L 5A1
Telephone: (514) 856-6928
FAX: (514) 856-6886

Sales Service: 1-800-826-6342 / 1-800-TC-OMEGASM
Customer Service: 1-800-622-2378 / 1-800-622-BESTSM
Engineering Service: 1-800-872-9436 / 1-800-USA-WHENSM
TELEX: 996404 EASYLINK: 62968934 CABLE OMEGA

Servicing Europe: United Kingdom Sales and Distribution Center

25 Swannington Road, Broughton Astley, Leicestershire
LE9 6TU, England
Telephone: 44 (0455) 285520 FAX: 44 (0455) 283912

The OMEGA Complete Measurement and Control Handbooks & Encyclopedias

- ✓ Temperature
- ✓ Pressure, Strain & Force
- ✓ Flow and Level
- ✓ pH and Conductivity
- ✓ Data Acquisition Systems
- ✓ Electric Heaters
- ✓ Environmental Monitoring and Control



Call for Your FREE Handbook Request Form Today: (203) 359-RUSH

TABLE OF CONTENTS

| <i>Paragraph</i> | <i>Title</i> | <i>Page</i> |
|--|--|-------------|
| SECTION 1 – Introduction | | |
| 1.1 | INTRODUCTION _____ | 1-1 |
| 1.2 | OPTIONS _____ | 1-2 |
| 1.3 | UNPACKING AND TESTING YOUR INDICATOR _____ | 1-3 |
| SECTION 2 – Installation/Wiring | | |
| 2.1 | INTRODUCTION _____ | 2-1 |
| 2.2 | CONNECTING DC POWER _____ | 2-1 |
| 2.3 | CONNECTING THE INPUT SENSOR _____ | 2-3 |
| 2.4 | OPTION INSTALLATION _____ | 2-4 |
| 2.4.1 | Disassembling Your Indicator _____ | 2-5 |
| 2.4.2 | Alarm Card, Configuration/Installation/Wiring _____ | 2-8 |
| 2.4.3 | Analog Output Card, Installation/Wiring _____ | 2-13 |
| 2.4.4 | Math and Scaling and Offset Cards, Installation _____ | 2-15 |
| 2.4.5 | Serial Output Card, Configuration/Installation/Wiring _____ | 2-17 |
| 2.4.6 | BCD Output Card, Installation/Wiring _____ | 2-23 |
| 2.4.7 | IEEE-488 Option, Installation and Wiring _____ | 2-25 |
| 2.5 | CHANGING THE INPUT RANGE CARD _____ | 2-28 |
| 2.6 | INSTALLING THE MULTI-INPUT OPTION _____ | 2-30 |
| 2.7 | INSTALLING THE DELTA INPUT OPTION _____ | 2-35 |
| 2.8 | INSTALLING THE DC POWER OPTION _____ | 2-39 |
| SECTION 3 – Operation | | |
| 3.1 | INTRODUCTION _____ | 3-1 |
| 3.2 | GETTING STARTED _____ | 3-1 |
| 3.3 | DISPLAY AND MAIN FRONT PANEL KEYS _____ | 3-2 |
| 3.3.1 | The 14-Segment LED Display _____ | 3-2 |
| 3.3.2 | The Main Front Panel Keys _____ | 3-3 |
| 3.4 | MULTI-INPUT/DELTA INPUT STEP KEY AND LED INDICATORS _____ | 3-4 |
| 3.5 | PROGRAMMING YOUR INDICATOR _____ | 3-6 |
| 3.5.1 | Introduction _____ | 3-6 |
| 3.5.2 | Program Lock-out Switch _____ | 3-6 |
| 3.5.3 | Programming Steps Overview _____ | 3-7 |
| 3.5.4 | Selecting the Input Range _____ | 3-9 |
| 3.5.5 | Calibrating the Indicator _____ | 3-13 |

| | | |
|---------|-----------------------------------|------|
| 3.5.5.1 | Sensor Callibration | 3-17 |
| 3.6 | USING THE SCALE AND OFFSET OPTION | 3-19 |
| 3.7 | USING THE ALARM OPTION | 3-25 |
| 3.7.1 | Introduction | 3-25 |
| 3.7.2 | Configuring the Alarm Card | 3-26 |
| 3.7.3 | Alarm Programming | 3-28 |
| 3.7.3.1 | Using Hysteresis | 3-30 |
| 3.7.3.2 | Using Alarm Delay | 3-31 |
| 3.8 | USING THE ANALOG OUTPUT OPTION | 3-32 |
| 3.8.1 | Analog Output Calibration | 3-35 |
| 3.9 | USING THE MATH OPTION | 3-36 |
| 3.9.1 | Introduction | 3-36 |
| 3.10 | USING THE SERIAL OUTPUT OPTION | 3-44 |
| 3.10.1 | Introduction | 3-44 |
| 3.10.2 | Serial Output Data Format | 3-44 |
| 3.11 | USING THE BCD OPTION | 3-47 |
| 3.12 | USING THE IEEE-488 OPTION | 3-49 |
| 3.12.1 | Introduction | 3-49 |
| 3.12.2 | Configuring the IEEE-488 Option | 3-50 |
| 3.12.3 | IEEE-488 Data I/O Format | 3-52 |

APPENDIX

| | |
|-------------------|-----|
| SPECIFICATIONS | A-1 |
| INPUT RANGE TABLE | A-3 |
| OUTLINE DRAWINGS | |

SECTION 1

INTRODUCTION

1.1 INTRODUCTION

Your Omega DP85/DP86 digital indicator is a microprocessor based, bench instrument that indicates the value of a linear voltage, linear current, thermocouple, RTD, or thermistor input.

Microprocessor power makes your DP85/DP86 indicator easy to use. Range selection, for example, is done by simply pressing a few keys instead of opening the instrument and changing a module as is typically done with other indicators. And to help you along the programming sequence, your DP85/DP86 indicator prompts you on the display for the appropriate entry or response.

The only difference between the DP85 and DP86 is in display/data output resolution. Model DP85 is a 4-digit instrument. Model DP86 is a 5-digit instrument. Both models have the same plug-in option card capacity—five maximum.

Here are some of the features designed into your DP85/DP86 indicator:

- Menu driven display prompts you for easy programming (configuration) and calibration of the indicator.
- Front panel water-resistant membrane switches for reliable operation in a wide range of operating environments.
- Plug-in Input Range Card accommodates a variety of input ranges of a particular input type. From a selection of 28 input ranges, you have five Input Range Card types from which to choose.
- Highly accurate integrating voltage-to-frequency converter (VFC).
- Easy to install optional plug-in cards expand instrument capability.

- Easy to read, 14-segment, alphanumeric LED display reads out engineering units of up to three characters.
- Easy to calibrate—no mechanical adjustments or ice baths needed.
- Rugged aluminum case protects components and shields against electrical interference for a long and reliable service life.
- Portable design uses a carrying handle that doubles as an adjustable tilt stand.

For your reference, refer to the appendix section in this manual for technical specifications.

1.2 OPTIONS

Optional plug-in cards enable a DP85/DP86 indicator to be used in many different applications. To give you an idea of what your indicator is capable of, here's a brief summary of the plug-in option cards:

Alarm Option. This option card allows you to monitor the input with two programmable alarm limits. Each alarm limit has an associated Form C relay to actuate an external device upon alarm. The alarm option card is also programmable for hysteresis, alarm delay, and automatic or manual reset.

Analog Output Option. This option card gives you a scalable analog output which corresponds to a display value as determined by your programming. The analog output card is available in 0-10 V and 4-20 mA output versions.

Math Option. This option card performs mathematical computations on the input to read out its maximum value, minimum value, time average, or rate of change.

Scaling and Offset Option. This option card gives additional linearization to the input by performing a scaling and offset ($mx + b$) operation. The resulting value is shown with engineering units that are programmed by

you.

Serial Output Option. This option card processes the information shown on the indicator's display readout into serial ASCII data. The data can be given to any computer or peripheral device with a serial I/O port.

BCD Output Option. This option card processes the information shown on the indicator's display readout into parallel BCD data. With handshake signals and tri-state controlled data lines, the BCD output option offers flexibility in data transmission to accommodate most BCD processors.

Other available options include a wide variety of multi-input switch cards (for handling multiple inputs), the Delta Input card (a 2-input switch card with selectable difference value display), and two versions of DC power cards (for operation on DC power). All options are field-installable. If you ordered your indicator and option separately, refer to Section 2 in this manual for instructions on how to install that option.

1.3 UNPACKING AND TESTING YOUR INDICATOR

After carefully unpacking your indicator, inspect it for possible shipping damage. Also check the shipment for correct accessories and options, then test the indicator for proper operation before placing it in service. *Promptly report physical damage, missing items, or improper operation to Omega's Customer Service Department: (203) 359-1660.the factory.*

To test your indicator, plug it into an active ac outlet and turn it on by pressing the POWER on/off button on the front panel. Now watch the readout for the start-up display routine which takes about 3-4 seconds to complete. If your indicator is OK, the display will show the word...

...*SELFTEST*, then the word...

...*PROCESS*, followed by...

...the value of the open input (*OVERLOAD* if thermocouple input).

If your indicator has not been programmed, the display will show the word:

...*SELFTEST*, then the word...

...*PROGRAM*, followed by the word...

...*INPUT*.

If the display routine ends with *INPUT*, your indicator is OK. However, your indicator expects you to select an input range before it can operate in any other mode. Program the indicator for the desired input range—refer to 3.5.3.1 for instructions on how to select the input range.

If your indicator is not OK, a diagnostic message will be displayed indicating the area of trouble. Refer to 3.2 for the list of diagnostic messages and descriptions.

SECTION 2

INSTALLATION/WIRING

2.1 INTRODUCTION

This section includes basic installation instructions in the areas of mounting, power hookup, and input sensor hookup.

Also included in this section are installation and/or hookup instructions for the various options. Refer to these instructions if your indicator uses options or if you've an option or add-on accessory that was ordered separately.

2.2 PANEL MOUNTING

Follow these step-by-step instructions to mount your indicator in a panel. Refer to Figure 2-1 on the next page for panel mounting details.

STEP 1. Prepare panel in which indicator is to be installed. See the outline drawing for your indicator model in the appendix section for the panel cutout dimensions. Note that the maximum panel thickness is 9.5 mm (3/8 in.).

STEP 2. Remove retainer bar brackets from rear of indicator (two screws). Slide retainer bar out from both sides of housing.

STEP 3. Install indicator in panel cutout from outside.

STEP 4. Reinstall indicator retainer bars.

STEP 5. Reinstall retainer bar brackets.

STEP 6. Clamp retainer bars to inside of panel by tightening retaining bar bracket screws (these screws push bracket against retainer bar). Tighten screws just enough so that indicator is firmly supported—be careful not to overtighten to avoid stripping threads.

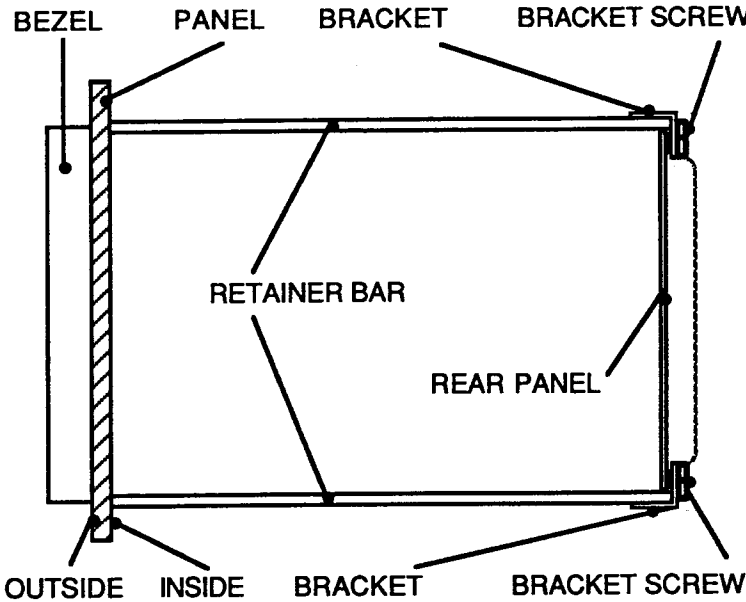

FIGURE 2-1. PANEL MOUNTING THE INDICATOR

2.3 RACK MOUNTING

Rack mounting adapters 90 mm x 483 mm (3.5" x 19") are available with cutouts for one, two, or three Model 610 indicators. For a Model 612 indicator, a rack mounting adapter with the same dimensions above is available with one cutout. All rack mounting adapters use 76.2 mm (3") hole centers.

Follow the instructions for panel mounting to install your indicator(s) into a rack mounting adapter's cutout(s). You will have to supply your own hardware to install the adapter into your rack system.

2.4 CONNECTING POWER

2.4.1 AC Power

We supply a 1.8 meter (6') polarized AC power cord assembly as standard for your indicator. Plug the mating connector end of the cord into the indicator's power receptacle in the lower rear panel. If you need a custom length power cord, the drawing below shows you how to make your own. The AC power cord mating connector—as well as the standard supplied AC power cord—is available from the factory as a spare/replacement part item.

WARNING!

To prevent shock hazard and to minimize electrical noise, you must always use a 3-prong grounded power cord for the indicator. If you must use an adapter, always connect the green lead of the adapter to earth ground. This can be the socket housing, conduit, water pipe, etc.

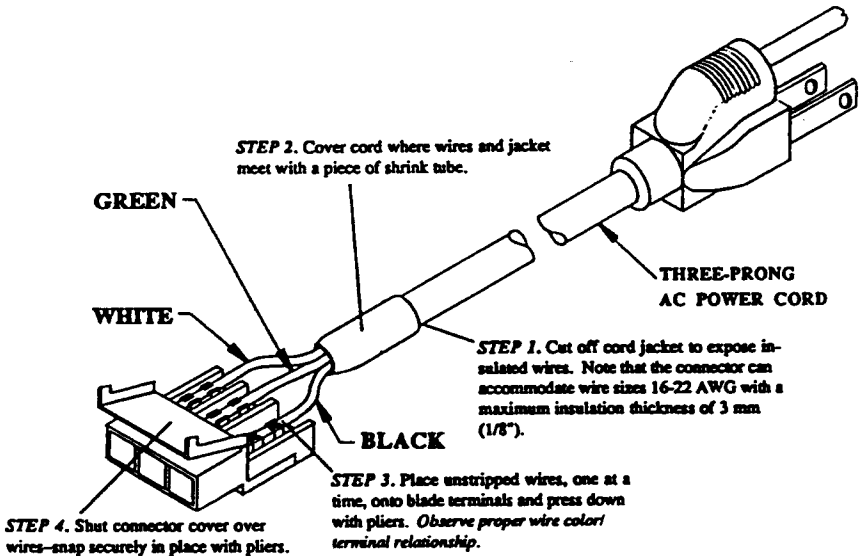

FIGURE 2-2. INSTALLING THE AC POWER CORD MATING CONNECTOR

2.4.2 DC Power

If your indicator is DC powered, a terminal strip on the DC power supply board provides the input power connection. To gain access to the input terminals, remove the indicator's upper rear panel by removing two screws and split washers (see the drawing of the rear panel in 2.5 below). See Figure 2-3 below for the polarity assignment of the DC input terminals. We recommend that you terminate the DC power leads in lugs to make the installation and removal of wires easier.

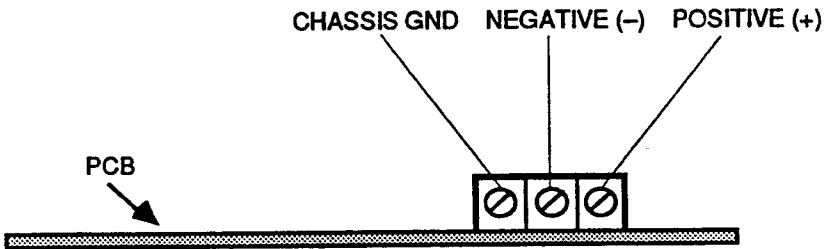
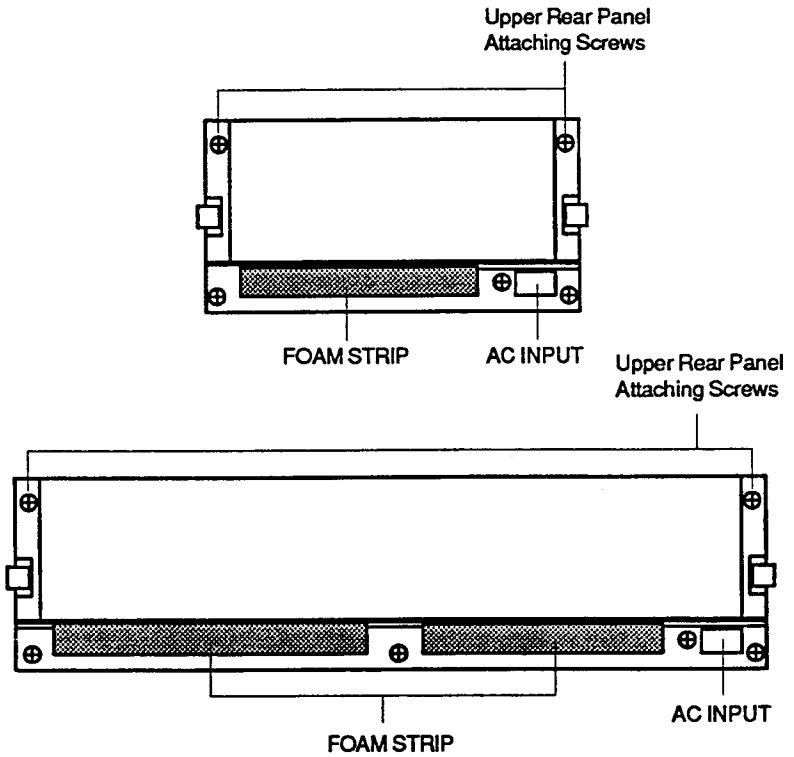

FIGURE 2-3. DC POWER INPUT TERMINALS

2.5 CONNECTING THE INPUT SENSOR

Four screw terminals on the main board are used to connect the input sensor. If your indicator has multi-input cards, it will have several quick connect screw terminal blocks depending on the number of cards. To gain access to the sensor input terminals, remove the indicator's rear panel:



Lay the sensor leads over the foam strip on the lower rear panel and connect to the appropriate input terminals as shown in Figure 2-4. Refer to the signal input diagram as specified by your type input.

NOTE

You should terminate all wires (except thermocouple leads) in lugs to make the installation and removal of wires easier. Never terminate thermocouple wires in lugs—simply wrap them around the screw terminals, being careful not to overtighten the screws.

MULTI-INPUT: See also page 2-38 for interconnects

THERMOCOUPLE (TC)/VOLTAGE/CURRENT RANGES

(TC/100 mV/1000 mV) (10 V/100 V/4-20 mA/10-50 mA)

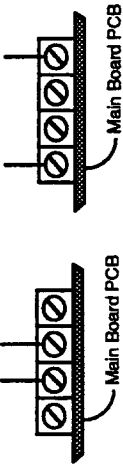

RTD RANGES

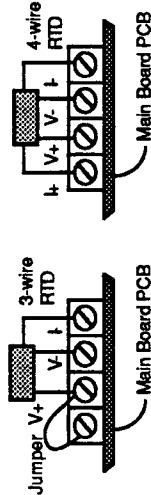

THERMISTOR RANGES

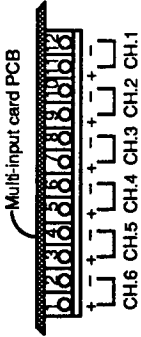
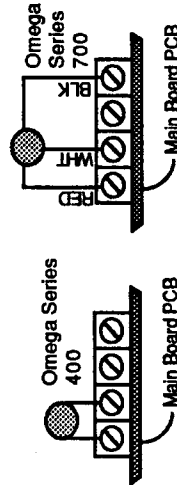

3-wire RTD Multi-Input Hook-up
Multi-input card PCB

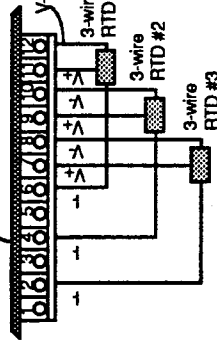

4-wire RTD Multi-Input Hook-up
Multi-input card PCB

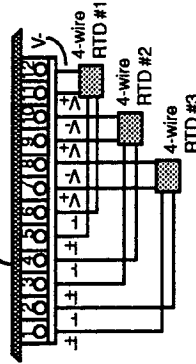

Omega Series 400 Multi-Input Hook-up
Multi-input card PCB

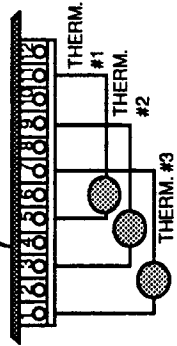

Omega Series 700 Multi-Input Hook-up
Multi-input card PCB

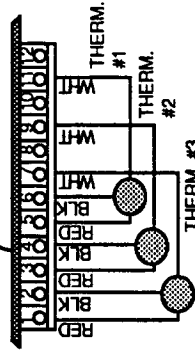

FIGURE 2-4. SENSOR INPUT CONNECTION DIAGRAMS

2.6 OPTION INSTALLATION

Various options are offered which may be installed by the factory or by you. If you've ordered an option separately, refer to its installation instructions in this section.

The indicator's slot locations are shown below for reference.

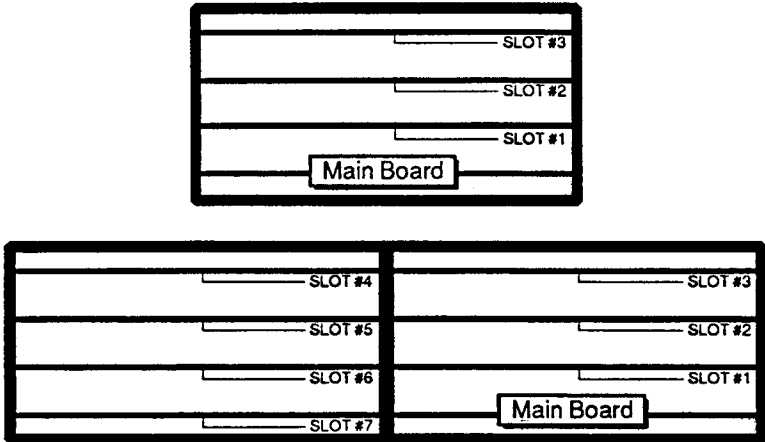

FIGURE 2-5. INDICATOR CARD SLOTS AS SEEN FROM REAR

POINTS TO CONSIDER WHEN INSTALLING OPTIONS

- Install all option cards, except multi-input and Delta input cards, component side up. A multi-input or Delta input card must be installed component side down.
- The Alarm card and Serial Output card require configuration before use.
- You can only use the topmost slot(s) for a multi-input card (slot #3 or slots #3 & #4) or Delta input card (slot #3 only).

- When a multi-input card is installed, the option slot directly below it is then limited to the installation of another multi-input card only. However, if a multi-input card is installed in slot #3, the slot below it (slot #2) must be left empty.
- A DC power supply card can only be installed in slot #1.

2.6.1 Disassembling Your Indicator

You will need to partially disassemble your indicator in order to change an input range card or to access the circuits for troubleshooting. This section describes the disassembly of key indicator components.

WARNING!

To prevent shock hazard and possible instrument damage, always remove power from the indicator before disassembling the instrument.

REAR PANEL. Five screws with lockwashers are used to attach the two-piece rear panel of single-wide units. For double-wide units, six attaching screws with lockwashers are used.

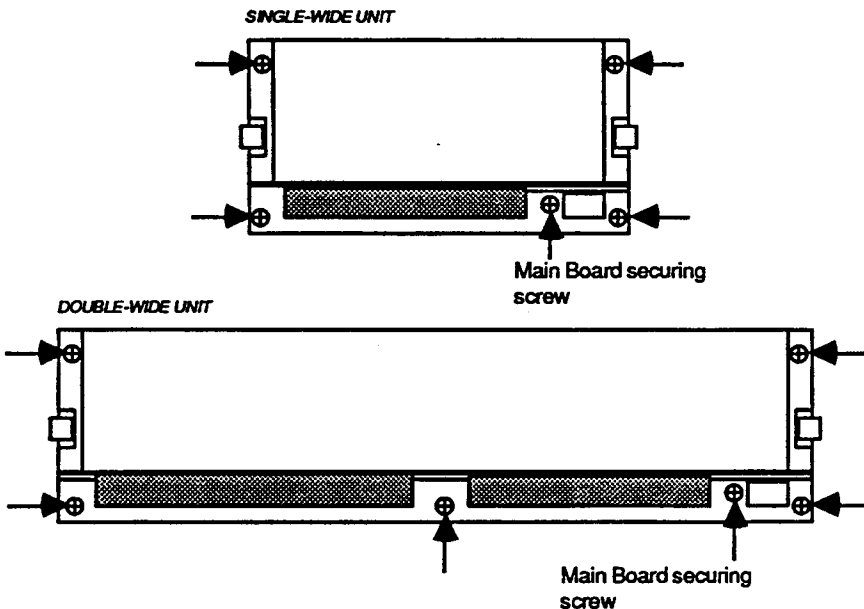

FRONT PANEL LENS. Two screws attach the front panel lens to the bezel. On double-wide units, the right half of the bezel is covered by a plastic facing which is also secured by two screws. Remove the lens (and facing if applicable) to access the motherboard and bezel attachment screws. Free the lens completely from the indicator, if necessary, by pulling its flat cable off of the socket on the display board (this is the vertical board with the display readout).

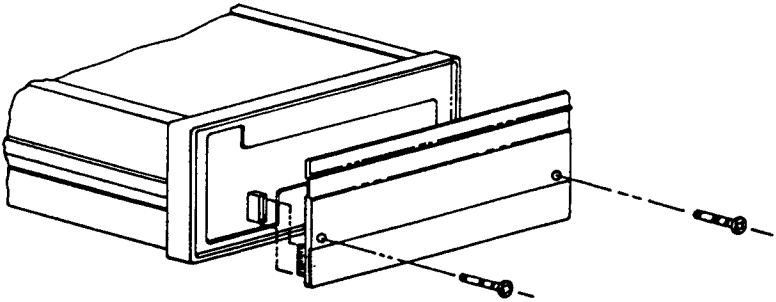

MOTHERBOARDS. The main motherboard assembly attaches to the bezel with two screws and lockwashers (illustrated with a single-wide unit below). The double-wide unit's expansion housing motherboard assembly attaches to the bezel with four screws and lockwashers.

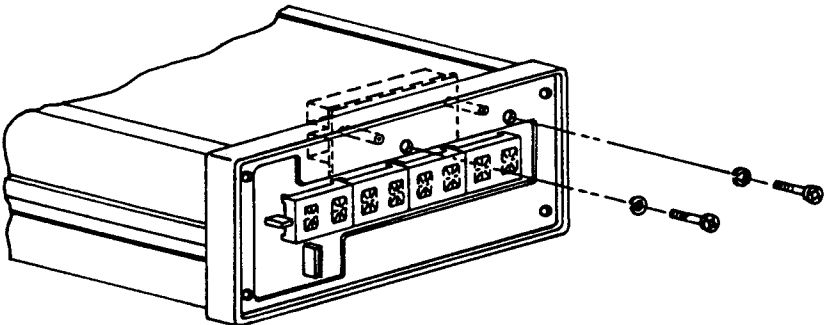

continued next page...

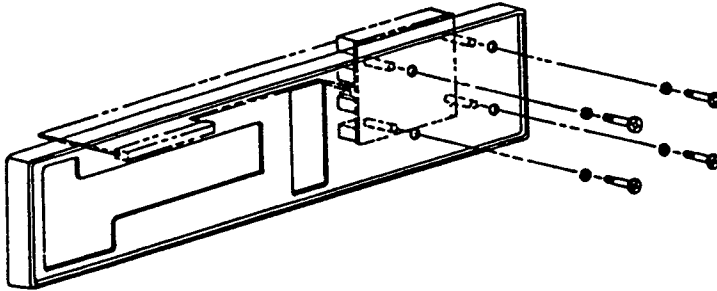

BEZEL. The bezel is attached to the housing with four screws for a single-wide unit and eight screws for a double-wide unit. For a double-wide unit, follow the bolting sequence (as shown by the numbers in the drawing below) when reinstalling the bezel. This will make it easier to install the screws. It will also reduce the chance of damaging the tapped holes in the housing due to cross threading.

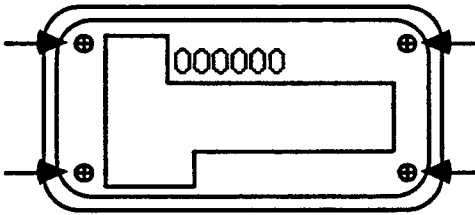

continued next page...

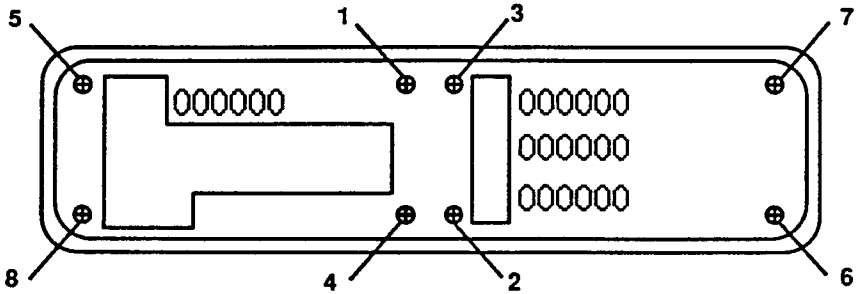

2.6.2 Alarm Card, Configuration/Installation/Wiring

Alarm Card Configuration

The alarm card is configurable for:

- Address
- Relay mode of operation

Configure the alarm card to your application before placing it in service in your indicator. Configuration is set by three removable jumper jacks which plug onto terminal pins on the card. See the drawing below for the location of the alarm card's terminal pins.

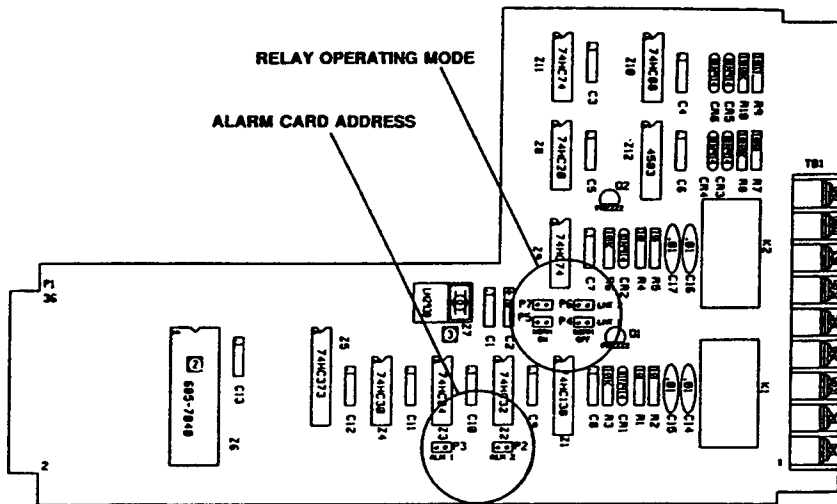

FIGURE 2-6. CONFIGURATION TERMINAL PINS, ALARM CARD

Configuring the Alarm Card for Address

Two pair of pins, P2 and P3, are used to set the card address. A removable jumper jack is installed on one of these pairs (typically the P3 location):

- Place the jumper jack over the pins in the P3 location to configure the card for alarm card #1. The relays on the alarm card, K1 and K2, will then respond to limits #1 and #2 respectively.
- Place the jumper jack over the pins in the P2 location to configure the card for alarm card #2. The relays on the alarm card, K1 and K2, will then respond to limits #3 and #4 respectively.

If you are going to use only one alarm card, configure that card as alarm card #1. Your indicator allows use of a single alarm card only with the alarm card #1 address. To allow your indicator to use two alarm cards, configure one alarm card for alarm card #1 and the other for alarm card #2. The use of two alarm cards requires that you always configure one alarm card—and one only—as alarm card #1.

With factory installed alarm card(s), it isn't necessary for you to configure for address. However, if you have two factory installed alarm cards in your indicator, verify the address configuration in order to determine the relay/limit number relationship.

Configuring the Alarm Card for Relay Operating Mode

You have the choice to have one or both relays on the alarm card to either pull up when tripped or drop out when tripped. A relay that drops out when tripped operates in the fail-safe mode. In the fail-safe mode, an unwanted loss of power naturally causes the relay contacts to drop out which in turn registers as an alarm trip by the system.

Two pin pairs are associated with each relay (K1 and K2). The operating mode of a particular relay is selected by jumpering one of the pin pairs with a jumper jack. The pin terminals and the associated relay operating mode is tabulated below:

| | | |
|---------------------|------------|----|
| | Relay Pins | |
| Relay State at Trip | K1 | K2 |
| Pull Up | P4 | P6 |
| Drop Out | P5 | P7 |

Let's say, for example, that you want both relays to drop out when tripped (this means of course that both relays will be pulled up when not tripped). Looking at the table above, you can see that jumper jacks need to be installed on the P5 and P7 pins in order for both relays to drop out on alarm.

The alarm card is supplied with the relay mode jumper jacks already on a pair of pin terminals. If you want to change the current relay mode configuration, pull the jumper jack(s) off the pins and reinstall on the alternate pair of pins as indicated in the table above.

Alarm Card Installation

The drawing below shows the possible indicator slots in which the alarm card may be inserted. Your indicator accommodates up to two (2) alarm cards.

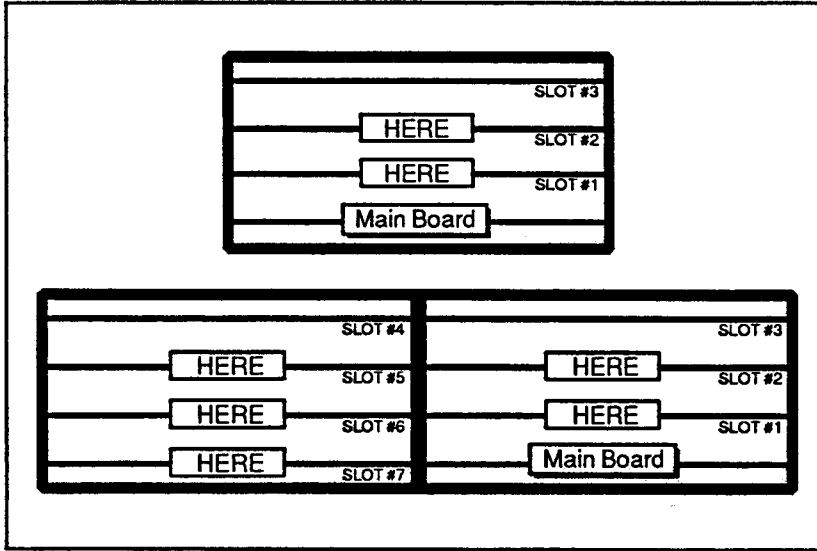

Installing the Alarm Card

To install the alarm card, follow these steps:

CAUTION

To ensure proper operation of your indicator, always remove power before removing or installing any card.

STEP 1. Remove the upper rear panel; leave the lower rear panel in place.

STEP 2. Plug the card(s) into the desired slot(s) with components facing up. See the drawing above for possible slot locations. Keep in mind that a particular combination of option cards may limit the number of slots in which a given option can be installed. Review the "Points to Consider" information in 2.6. (*Is the Alarm card already configured to your application?*)

Configure this card first—refer to the instructions above—before the final installation.)

STEP 3. Wire the alarm card. The discussion on wiring follows these installation steps.

STEP 4. After wiring, reinstall the upper rear panel to complete the installation if no other cards are to be installed. Route all wires to/from the indicator over the foam strip on the lower rear panel. This completes installation of this option. Removal of the option card is the reverse of installation.

Alarm Card Wiring

The alarm card uses a screw terminal barrier strip for the hook up. Remove the upper rear panel to gain access to these terminals. We recommend that you terminate all wires in lugs to make the installation and removal of wires easier. See the drawing below for the number/function assignment of the alarm card's screw terminals. Route all wiring to/from the indicator over the foam strip on the lower rear panel.

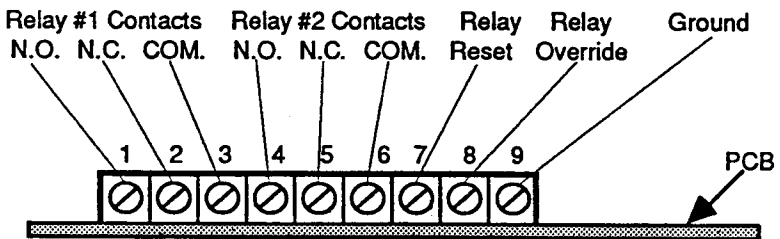

FIGURE 2-7. ALARM CARD TERMINALS

Wiring the Alarm Card

Relay Contacts

WARNING!

Lethal AC power voltages may be present on barrier terminals (relay contact wiring). Always exercise caution when working in this area.

The alarm card has two Form C relays that actuate on alarm. Each relay has a common contact, a normally closed (N.C.) contact, and a normally open (N.O.) contact. You can use the relay contacts to operate alarm annunciating devices such as lights and audio alarms or to electrically actuate a valve or a switch.

Wire your alarm relay circuit to the relay contacts at the appropriate screw terminals as shown in the drawing above. Before you hook up the relay contacts, make sure that the circuit will not exceed the relay's contact rating of:

1 Amp @ 120 VAC (non-inductive load)

Relay Reset

The alarm card's relay reset terminal accepts an external switch closure (to ground) which is needed to reset a tripped relay when the manual reset mode is selected. (A full discussion on the reset modes is found in the operation section of the manual.)

To hook up the relay reset switch, connect a normally open, momentary contact switch between terminal #7 (relay reset) and terminal #9 (ground) using a twisted pair cable. A push of this switch will reset the relay(s) to the untripped condition only if the associated alarm limit is no longer exceeded. If you actuate the relay reset switch with a limit still exceeded, there will be no effect on the relays. This switch will also have no effect on the relays if the automatic reset mode is selected.

Relay Override

The alarm card has a relay override feature which allows you to (1) prevent relays from being tripped or to (2) force tripped relays to the untripped state. You can use relay override to prevent unnecessary tripping of the alarm relays when performing system tests. You can also use relay override to kill an alarm annunciating device—a 120 dB klaxon let's say—after it has gotten your attention. Relay override does not affect the indication of alarms on the front panel display.

To use relay override, connect a SPST toggle or rocker switch between terminal #8 (relay override) and terminal #9 (ground) using a twisted pair cable. Close the switch whenever you want the relays in the untripped state. Note that both relays will remain in the untripped state regardless of alarm condition as long as this switch is closed.

2.6.3 Analog Output Card, Installation/Wiring

Analog Output Card Installation

The drawing below shows the possible indicator slots in which the analog output card may be inserted. Your indicator can use only one (1) analog output card.

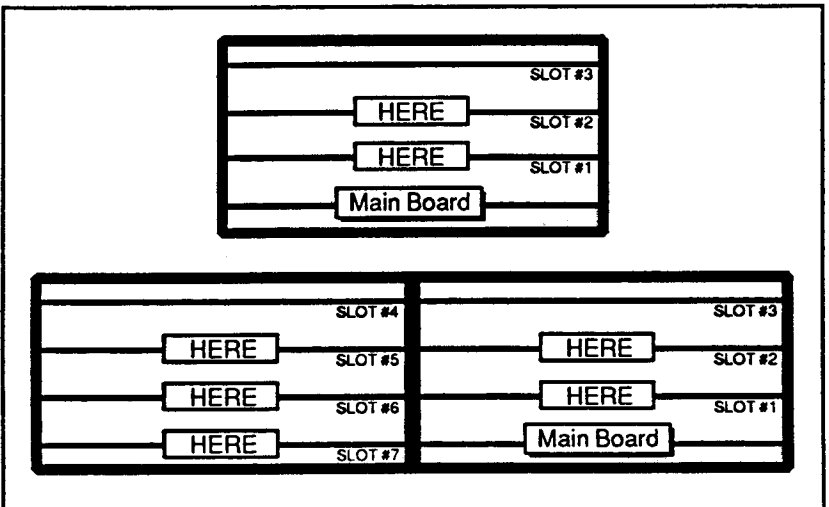

Installing the Analog Output Card

To install the analog output card, follow these steps:

CAUTION

To ensure proper operation of your indicator, always remove power before removing or installing any card.

STEP 1. Remove the upper rear panel; leave the lower rear panel in place.

STEP 2. Plug the card into the desired slot with components facing up. Keep in mind that a particular combination of option cards may limit the number of slots in which a given option can be installed. Review the "Points to Consider" information in 2.6.

STEP 3. Wire the analog output card. The discussion on wiring follows these installation steps.

STEP 4. After wiring, reinstall the upper rear panel to complete the installation if no other cards are to be installed. Route all wires to/from the indicator over the foam strip on the lower rear panel. This completes installation of this option. Removal of the option card is the reverse of installation.

Wiring the Analog Output Card

A pair of screw terminals on terminal strip TB1 provides the output connection from the analog output card. Remove the upper rear panel to gain access to these terminals. See the drawing below for the polarity assignment of the analog output card's output terminals. Route all wires to/from the indicator over the foam strip on the lower rear panel.

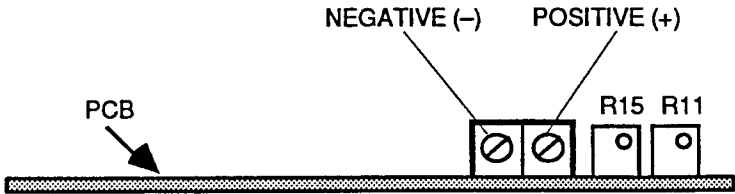

FIGURE 2-8. ANALOG OUTPUT CARD OUTPUT TERMINALS

Use a twisted pair cable for connecting the analog output to the external device input—this will minimize noise pickup. In order to provide the proper output, the analog output card must be used with devices having an input impedance of:

- 1 k Ω or greater for a 0-10 V analog output card
- 600 Ω or less for a 4-20 mA analog output card

Make sure that the external device to be used has an allowable input impedance before proceeding with the hook up.

2.6.4 Math and Scaling and Offset Cards, Installation

The Math and Scaling and Offset cards require no configuration or wiring. The following describes how these cards are installed in the indicator.

The drawing below shows the possible indicator slots in which the Math and Scaling and Offset cards may be inserted.

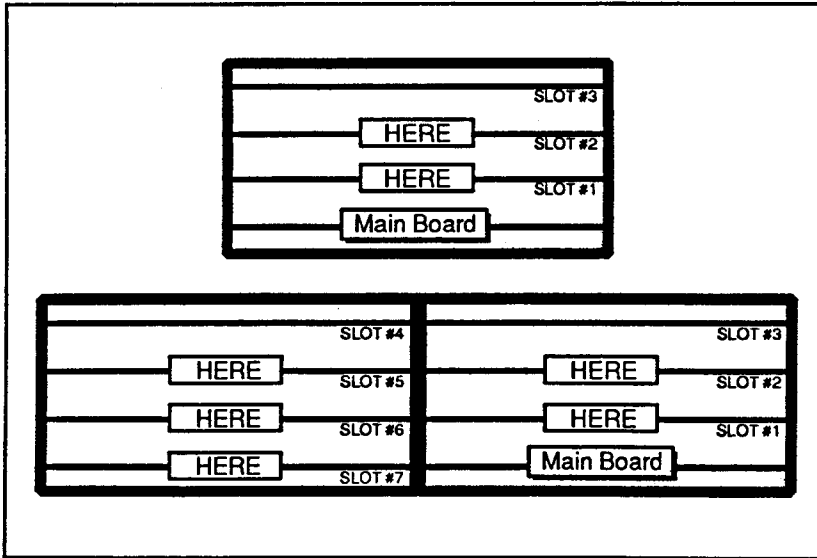

To install the Math and/or Scaling and Offset cards, follow these steps:

CAUTION

To ensure proper operation of your indicator, always remove power before removing or installing any card.

STEP 1. Remove the upper rear panel; leave the lower rear panel in place.

STEP 2. Plug the card(s) into the desired slot(s) with components facing up. See the drawing above for possible slot locations. Keep in mind that a particular combination of option cards may limit the number of slots in which a given option can be installed. Review the "Points to Consider" information in 2.6.

STEP 3. If no other cards are to be installed, reinstall the upper rear panel to complete the installation. Route all wires to/from the indicator over the foam strip on the lower rear panel. This completes installation of this option. Removal of the option card is the reverse of installation.

2.6.5 Serial Output Card, Configuration/Installation/Wiring

Serial Output Card Configuration

The serial output card is configurable for:

- Operating mode: RS-232C or 20 mA current loop (Active or Passive)
- Baud rate
- Character format
- Device number
- Termination characters

Configure the serial output card to your application before placing it in service in your indicator. Configuration is set by two removable jumper jacks (which plug onto terminal pins on the card) and two miniature DIP switch assemblies. See the drawing below for the location of the serial output card's terminal pins and DIP switches.

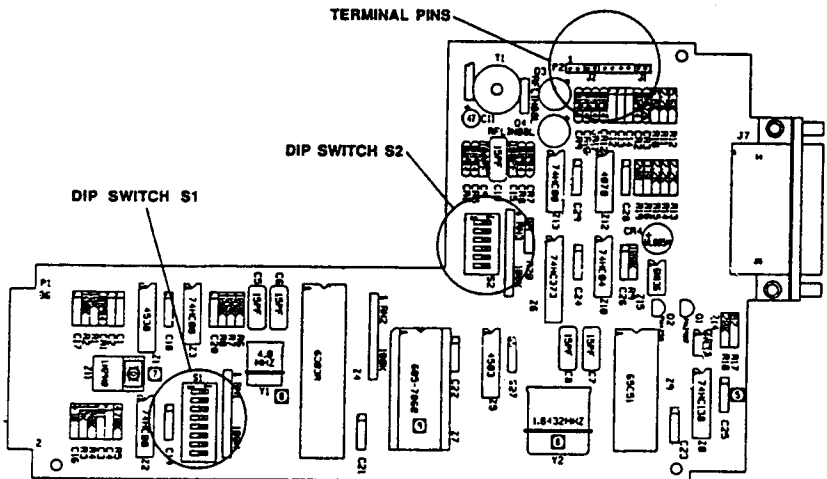

FIGURE 2-9. TERMINAL PINS AND DIP SWITCHES, SERIAL OUTPUT CARD

Configuring the Serial Output Card for Operating Mode

Ten pins (J2) are used to determine the serial output card's operating mode. In the drawing above, pin 1 is the leftmost pin, so the order is one through ten left to right. Select the desired operating mode by placing two jumper jacks over two pair of pins as indicated in the table below:

| To Select: | Place Jumpers on Pin Pairs |
|----------------|-------------------------------|
| 20 mA, Passive | 9,10 3,4 |
| 20 mA, Active | 5,6 1,2 |
| RS-232C | 7,8 1,2 |

Configuring the Serial Output Card for
Baud rate/Character format/Device number/Termination characters

The serial output card uses two DIP switch assemblies for configuration. These DIP switches will be one of two general types, a *rocker* switch or *slide* switch. At any rate, each individual switch will have two positions. Look at the face of the switch assembly right side up (lettering and/or numbering clearly readable):

- To set a switch to the **CLOSED/ON** position...
 - ...push the switch down at the top (rocker switch)
 - ...or slide the switch towards the top (slide switch).

- To set a switch to the **OPEN/OFF** position...
 - ...push the switch down at the bottom (rocker switch)
 - ...or slide the switch towards the bottom (slide switch).

Switch S1—Baud Rate and Character Format

Set switch S1 for the baud rate and character format as required for your application per the tables below. Note that an "X" indicates an OPEN/OFF switch and an "O" indicates a CLOSED/ON switch.

S1 1 2 3 4 5 6 7 8
 baud *word* *stop* *parity*

| BAUDRATE | | | |
|----------|---|---|------|
| 1 | 2 | 3 | Rate |
| O | O | O | 300 |
| X | O | O | 600 |
| O | X | O | 1200 |
| X | X | O | 1800 |
| O | O | X | 2400 |
| X | O | X | 3600 |
| O | X | X | 4800 |
| X | X | X | 9600 |

| WORD | | |
|------|---|----------|
| 4 | 5 | Bit Size |
| O | O | 8 bits |
| X | O | 7 bits |
| O | X | 6bits* |
| X | X | 5 bits* |

| PARITY | | |
|--------|---|-------------|
| 7 | 8 | Condition |
| O | O | no parity |
| X | O | odd parity |
| O | X | no parity |
| X | X | even parity |

| STOP BITS | |
|-----------|----------|
| 6 | Qty Bits |
| O | 1 bit |
| X | 2 bits |

* These bit sizes aren't normally used since it results in truncated characters. Data is transmitted out the serial port using 7-bit ASCII characters.

NOTE_____

If a word size of 8 is selected at 300 baud, the data is forced to *no parity* and *1 stop bit* regardless of the DIP switch settings. This is done to meet the transfer rate required to keep up with the reading's 1/2 second conversion time.

Switch S2—Device Address and Termination Characters

Your indicator must be assigned a unique address—a number between 00 and 16—in order to identify the data. Termination characters are used to control a cursor or printing mechanism at the end of the transmitted data.

Set switch S2 for the device address and data termination characters as required for your application per the tables below. Note that an "X" indicates an OPEN/OFF switch and an "O" indicates a CLOSED/ON switch.

S2 1 2 3 4 5 6
 device *terminator*

| Device Address | | | | |
|----------------|---|---|---|----|
| 1 | 2 | 3 | 4 | # |
| O | O | O | O | 01 |
| X | O | O | O | 02 |
| O | X | O | O | 03 |
| X | X | O | O | 04 |
| O | O | X | O | 05 |
| X | O | X | O | 06 |
| O | X | X | O | 07 |
| X | X | X | O | 08 |

| Device Address | | | | |
|----------------|---|---|---|----|
| 1 | 2 | 3 | 4 | # |
| O | O | O | X | 09 |
| X | O | O | X | 10 |
| O | X | O | X | 11 |
| X | X | O | X | 12 |
| O | O | X | X | 13 |
| X | O | X | X | 14 |
| O | X | X | X | 15 |
| X | X | X | X | 16 |

| Termination Characters | | |
|------------------------|---|--------------------|
| 5 | 6 | Characters |
| O | O | Space, Space |
| X | O | Space, CR (return) |
| O | X | CR, LF (line feed) |
| X | X | Space, LF |

Serial Output Card Installation

The drawing below shows the possible indicator slots in which the serial output card may be inserted. Your indicator can use only one (1) serial output card.

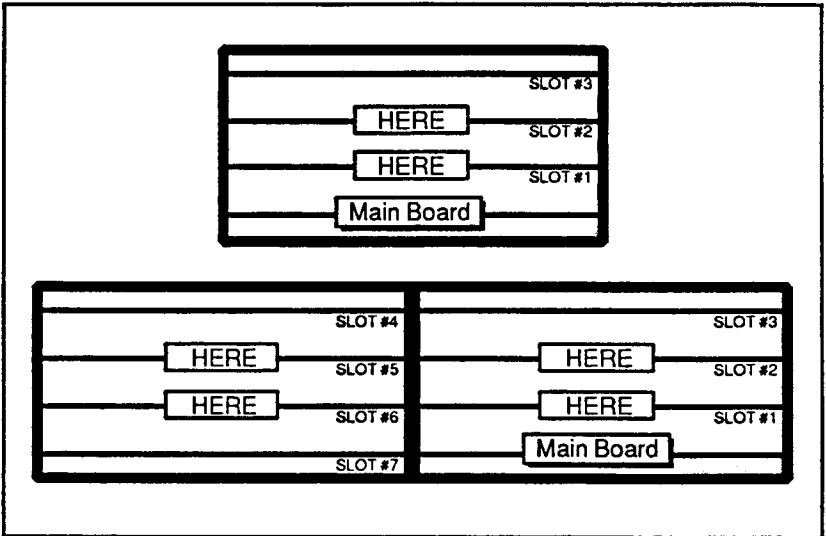

Installing the Serial Output Card

To install the serial output card, follow these steps:

CAUTION

To ensure proper operation of your indicator, always remove power before removing or installing any card.

STEP 1. Remove the upper rear panel; leave the lower rear panel in place.

STEP 2. Plug the card into the desired slot with components facing up. See the drawing above for possible slot locations. Keep in mind that a particular combination of option cards may limit the number of slots in which a given option can be installed. Review the "Points to Consider" information in 2.6.

STEP 3. Peel off the foil cover sticker on the upper rear panel to expose the panel cutout. If the rear panel is from a unit with the expansion housing (double width), peel off the left or right sticker according to the serial output card's slot location. After peeling off the foil sticker—and if no other cards are to be installed—reinstall the upper rear panel. (*Is the serial*

output card already configured to your application? Configure this card first—refer to the instructions above—before the final installation.)

STEP 4. With the serial output card in its slot and the rear panel in place, cover the rear panel cutout with one of the two self-adhesive foil cover plates supplied with the option.

NOTE

Both cover plates have a cutout for the serial output card connector. One plate, however, is used for an upper slot card. The other plate is used for a lower slot card.

After removing the backing, place the appropriate cover sticker over the Serial Output card connector and stick it onto the rear panel. This completes installation of this option. Removal of the option card is the reverse of installation.

Wiring the Serial Output Card

The indicator interfaces to the external serial device via the serial output card's cable connector (J7). The required mating connector is a 25-pin, male "D" type connector. Shown below is a drawing of the serial output card's connector as seen from the rear of the indicator. The table next to it lists the function of the pin sockets by pin number. Use this information to interface your indicator to the external device.

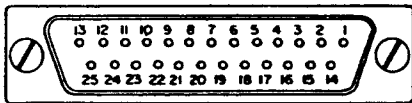

These pins supply +14V for use as a pull up if required.

| J7 PIN # | FUNCTION |
|---------------------------|---------------------|
| <i>RS-232C</i> | |
| 1 | chassis ground |
| 2 | transmit data |
| 4* | request to send |
| 5 | clear to send |
| 7 | signal ground |
| 20* | data terminal ready |
| <i>20 mA Current Loop</i> | |
| 11 | transmit (+) |
| 25 | transmit (-) |

2.6.6 BCD Output Card, Installation/Wiring

BCD Output Card Installation

The drawing below shows the possible indicator slots in which the BCD output card may be inserted. Your indicator can use only one (1) BCD output card.

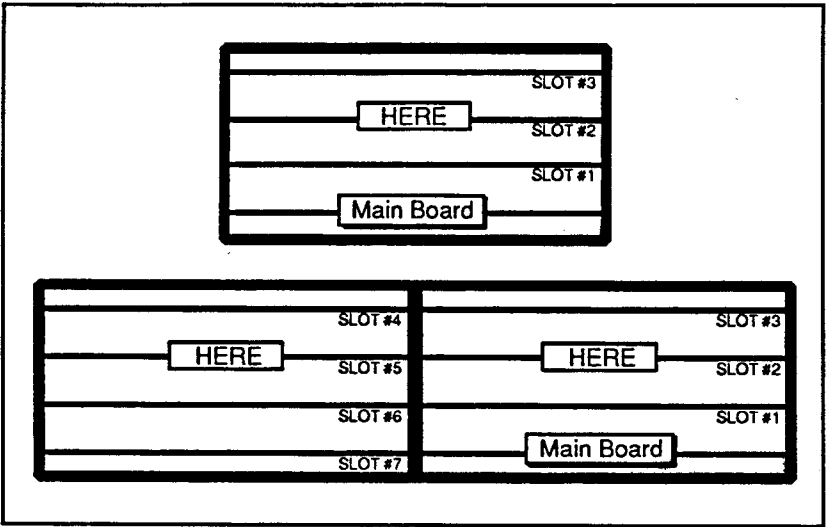

Installing the BCD Output Card

To install the BCD output card, follow these steps:

CAUTION

To ensure proper operation of your indicator, always remove power before removing or installing any card.

STEP 1. Remove the upper rear panel; leave the lower rear panel in place.

STEP 2. Plug the card into the desired slot with components facing up. See the drawing above for possible slot locations. Keep in mind that a

particular combination of option cards may limit the number of slots in which a given option can be installed. Review the "Points to Consider" information in 2.6.

STEP 3. Peel off the foil cover sticker on the upper rear panel to expose the panel cutout. If the rear panel is from a unit with the expansion housing (double-width), peel off the left or right sticker according to the BCD output card's location. After peeling off the foil sticker—and if no other cards are to be installed—reinstall the upper rear panel.

STEP 4. With the BCD output card in its slot and the rear panel in place, cover the rear panel cutout with the self-adhesive cover plate supplied with the option. After removing the backing, center the cover plate cutout over the BCD card's contact fingers and stick it onto the panel. This completes installation of this option. Removal of the option card is the reverse of installation.

Wiring the BCD Output Card

External connections to the BCD output card are made via the 30-pin mating connector provided with the option. Use this connector to make an interconnecting cable as required for your application. Cable connections are shown in the drawing below.

*DATA IS POSITIVE TRUE LOGIC,
 LSTTL AND CMOS COMPATIBLE*

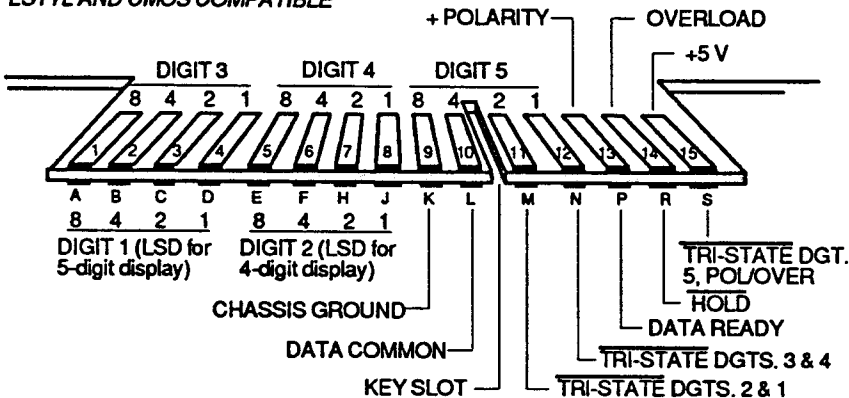

2.6.7 IEEE-488 Option, Installation and Wiring

Installing the IEEE-488 Option

Two plug-in circuit boards make up the IEEE-488 option. Before installing the option, connect the two boards together by plugging the bottom board's (IEEE-488 Power Supply PCB) ribbon cable connector to the top board's socket as shown in the drawing below.

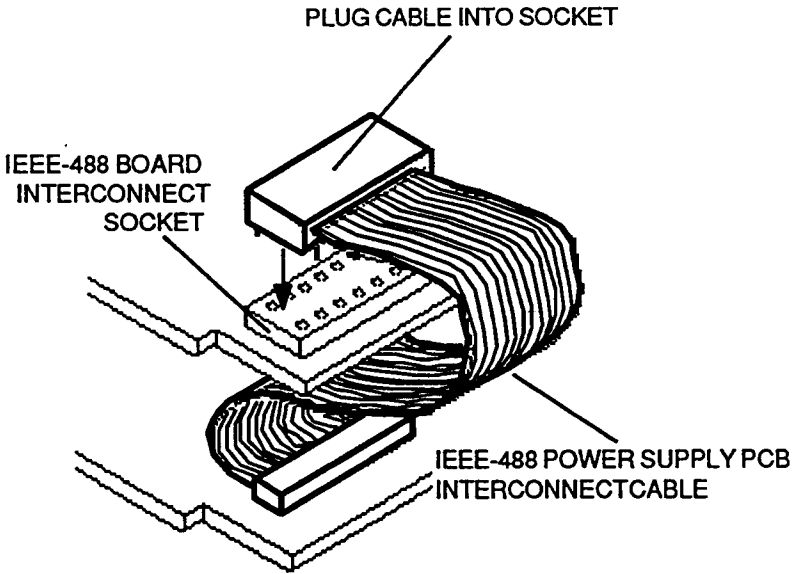

The drawing below shows the possible indicator slots in which the IEEE-488 option cards may be installed. Your indicator can use only one (1) IEEE-488 option.

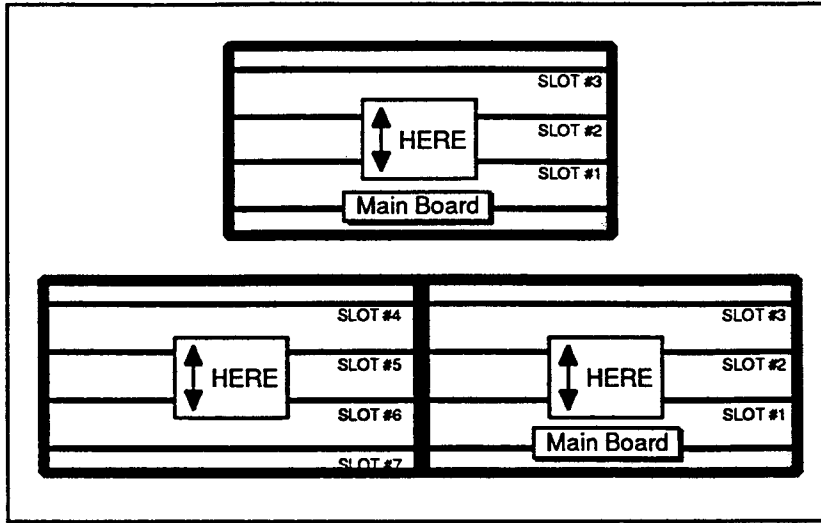

To install the IEEE-488 option, follow these steps:

CAUTION

To ensure proper operation of your indicator, always remove power before removing or installing any card.

STEP 1. Remove the rear panel.

STEP 2. Plug the cards into the indicator with components facing up—the card with the IEEE-488 connector goes on top. See the drawing above for possible slot locations. Keep in mind that a particular combination of option cards may limit the number of slots in which a given option can be installed. Review the "Points to Consider" information in 2.7.

STEP 3. Peel off the foil cover sticker on the rear panel to expose the panel cutout. If the rear panel is from a unit with the expansion housing (double-width), peel off the left or right sticker according to the IEEE-488 option's location. After peeling off the foil sticker—and if no other cards are to be installed—reinstall the upper rear panel.

STEP 4. With the IEEE-488 option cards installed in the indicator and the rear panel in place, cover the rear panel cutout with the self-adhesive cover plate supplied with the option. After removing the backing, center the cover plate cutout over the IEEE-488 connector and stick it onto the panel. This completes installation of this option. Removal of the option cards is the re-verse of installation.

Wiring the IEEE-488 Option

Connect your indicator to other IEEE-488 devices with a IEEE-488 interconnecting cable. Contact assignments for the IEEE-488 option's 24-pin connector are shown in the table below as specified by the IEEE-488 specification.

| Contact | Signal Line | Contact | Signal Line |
|---------|-------------|---------|-------------|
| 1 | DIO 1 | 13 | DIO 5 |
| 2 | DIO 2 | 14 | DIO 6 |
| 3 | DIO 3 | 15 | DIO 7 |
| 4 | DIO 4 | 16 | DIO 8 |
| 5 | EOI (24) | 17 | REN (24) |
| 6 | DAV | 18 | Gnd (6) |
| 7 | NRFD | 19 | Gnd (7) |
| 8 | NDAC | 20 | Gnd (8) |
| 9 | IFC | 21 | Gnd (9) |
| 10 | SRQ | 22 | Gnd (10) |
| 11 | ATN | 23 | Gnd (11) |
| 12 | SHIELD | 24 | Gnd LOGIC |

NOTE: Gnd (*n*) refers to the signal ground return of the referenced contact. EOI and REN return on contact 24.

2.7 CHANGING THE INPUT RANGE CARD

Your indicator accepts a particular family of sensor inputs via its plug-in input range card. There are five different input range cards, these include thermocouple, linear voltage, current, RTD, and thermistor types. All input range cards are available separately for use as spares or for later conversion of the indicator to another type input.

Before you start replacing the input range card, remove power from the indicator. Next, remove all wires and cables from the rear. Then remove all option cards, if any, from the indicator.

If your indicator is a single wide unit (that is, it has slots 1-3 only), follow these steps:

NOTE

Refer to 2.6.1 for drawings detailing disassembly.

STEP 1. Remove indicator's plastic front panel lens (two screws). Free lens completely from indicator by removing its flat cable from socket on display board (this is the vertical board with the display readout). The flat cable connects the membrane switches which make up the main front panel keys.

STEP 2. Completely remove indicator's rear panel (both upper and lower sections).

STEP 3. Remove two screws and washers from front of bezel to free motherboard.

STEP 4. Slide electronics out from rear of housing. Proceed to step 5.

If your indicator is a double wide unit (that is, it has slots 1-7), follow these steps:

NOTE

Refer to 2.6.1 for drawings detailing disassembly.

STEP 1. Reinstall indicator's rear panel; however, leave out screw and washer holding main board to lower rear panel. Remove indicator from its installed position.

STEP 2. Remove indicator's plastic front panel lens and facing (four screws). Free lens completely from indicator by removing its flat cable from socket on display board (this is the vertical board with the display readout). The flat cable connects the membrane switches which make up the main front panel keys.

STEP 3. Free bezel from housing by removing eight screws and washers.

STEP 4. Slide electronics out from front by pulling bezel (with motherboards and main board attached) away from housing. Proceed to step 5.

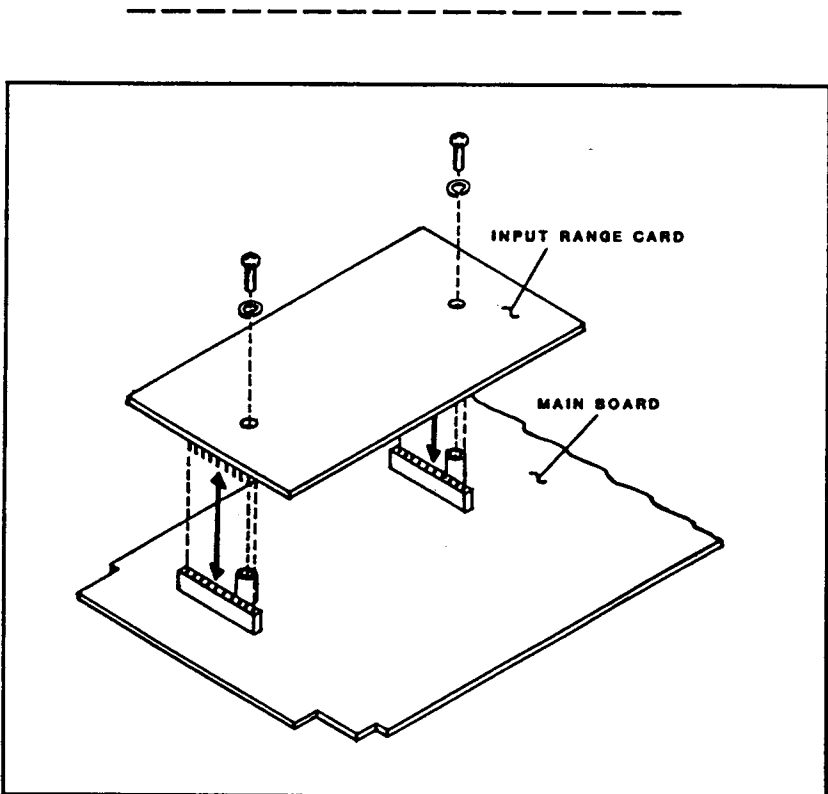

Section 2 INSTALLATION/WIRING

STEP 5. Remove 2 screws and washers holding input range card to main board standoffs (see drawing above). Pull input range card straight up from main board sockets to remove. Replace with new input range card, making sure that the main board sockets engage all pins on the input range card.

If you are installing a thermocouple input range card, you must verify the card configuration for *upscale* or *downscale* break detect. This is set by a jumper jack which is already installed over a pair of pins on the card.

- Upscale break detect: an open thermocouple causes a positive overload.
- Downscale break detect: an open thermocouple causes a negative overload.

Place the jumper jack over the alternate pair of pins if required for your application. See the drawing below for jumper jack positions.

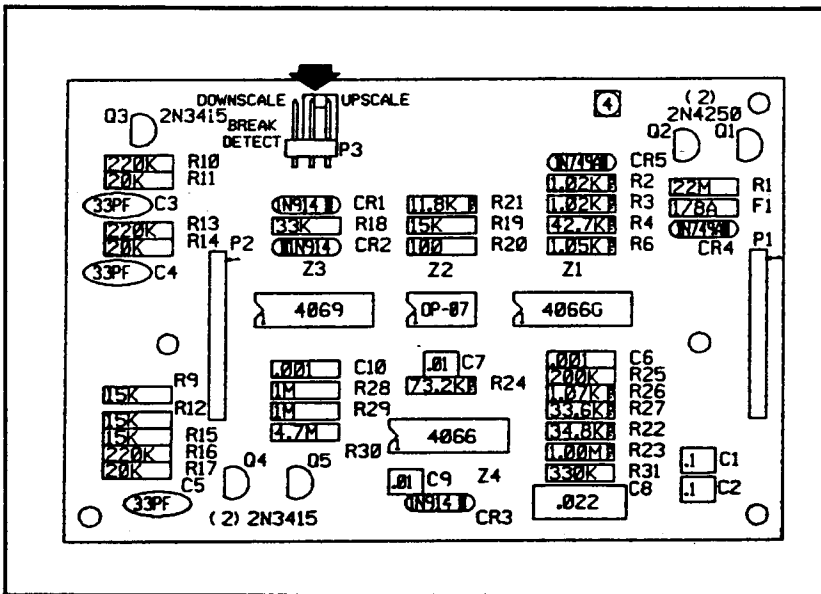

STEP 6. After installing new input range card, reassemble indicator (reassembly is reverse of removal).

STEP 7. If the new input range card is a different type from the one replaced, select an input range (3.5.4) and recalibrate accordingly (3.5.5).

2.8 INSTALLING THE MULTI-INPUT OPTION

The multi-input option allows a single indicator to accept multiple input sources. The possible multi-input indicator configurations are:

- 6 inputs, 2-wire (*one* multi-input card)
- 12 inputs, 2-wire (*two* multi-input cards)
- 18 inputs, 2-wire (*three* multi-input cards)
- 24 inputs, 2-wire (*four* multi-input cards)
- 3 inputs, 3-/4-wire (*one* multi-input card)
- 6 inputs, 3-/4-wire (*two* multi-input cards)
- 9 inputs, 3-/4-wire (*three* multi-input cards)
- 12 inputs, 3-/4-wire (*four* multi-input cards)

Multi-inputs require plug-in to front panel "step" key switches and interconnecting wires to the main board.

A multi-input card uses quick disconnect terminals blocks that can be removed with wires still attached. This allows you to easily remove or swap a multi-input card without the need to undo all the connections. To connect a wire, loosen the screw, insert the stripped lead into the terminal block and re-tighten the screw.

To remove all wiring from a multi-input card, pull the terminal blocks off.

The drawing below shows the possible indicator slots in which a multi-input card may be inserted.

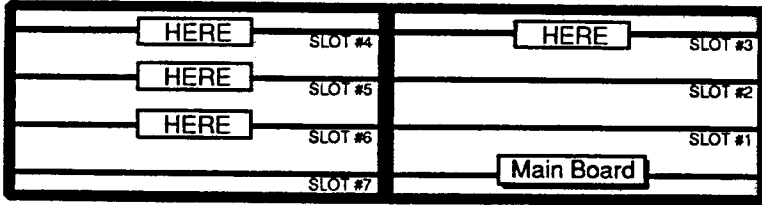
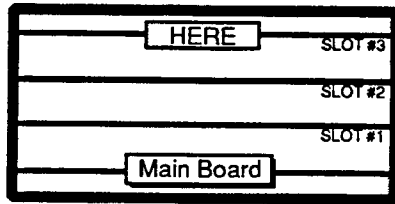

To install the multi-input option, follow these steps:

CAUTION

To ensure proper operation of your indicator, always remove power before removing or installing any card.

STEP 1. Remove upper rear panel (two screws and washers).

STEP 2. Remove front panel lens (two screws) from indicator—unplug lens keyboard cable from display board. If the multi-input option to be installed includes more than six 2-wire inputs or three 4-wire inputs, remove the expansion housing lens (two screws) which is to the right of the main front panel lens. The removed lens assemblies will be replaced by new ones in the kit. The new lens assemblies include all required switches.

STEP 3. Plug quick disconnect terminal blocks to multi-input board(s) header pins. Orient terminal blocks so that terminal numbers (1-4, 1-12) are right side up.

STEP 4. Plug multi-input card(s) into desired slot(s) with components facing down. Keep in mind that a particular combination of option cards may limit the number of slots in which a given option can be installed. Review the "Points to Consider" information in 2.6.

STEP 5. Verify proper alignment of the LED lamps in the bezel holes. Adjust if necessary for better viewing.

STEP 6. Plug membrane switch connector(s) into associated 3-pin connector plug on multi-input card. The multi-input card cable connectors are accessible through the bezel cutout. The drawing below shows you how the cable folds around the edge of the lens. Space is tight when plugging in several cards. A small screw driver or other tool may be necessary to push correctors in in the membrane connectors.

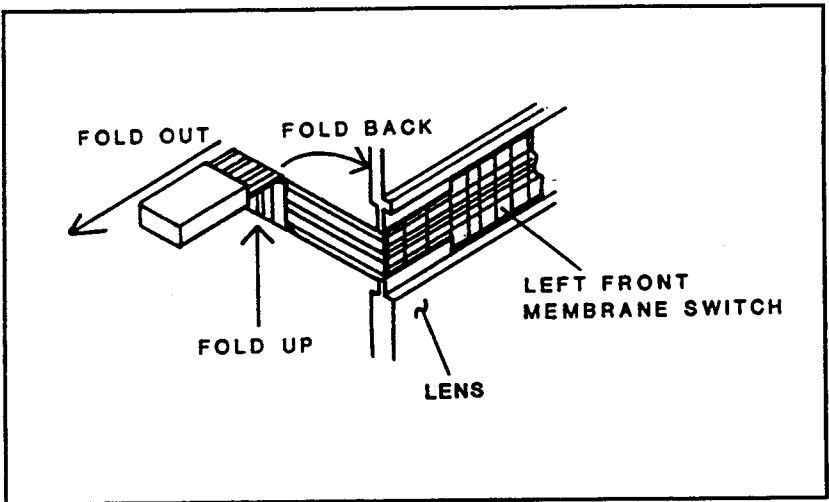

STEP 7. Plug cable from main front panel keys into display board socket.

STEP 8. After plugging in all switches, attach lens assembly to bezel.

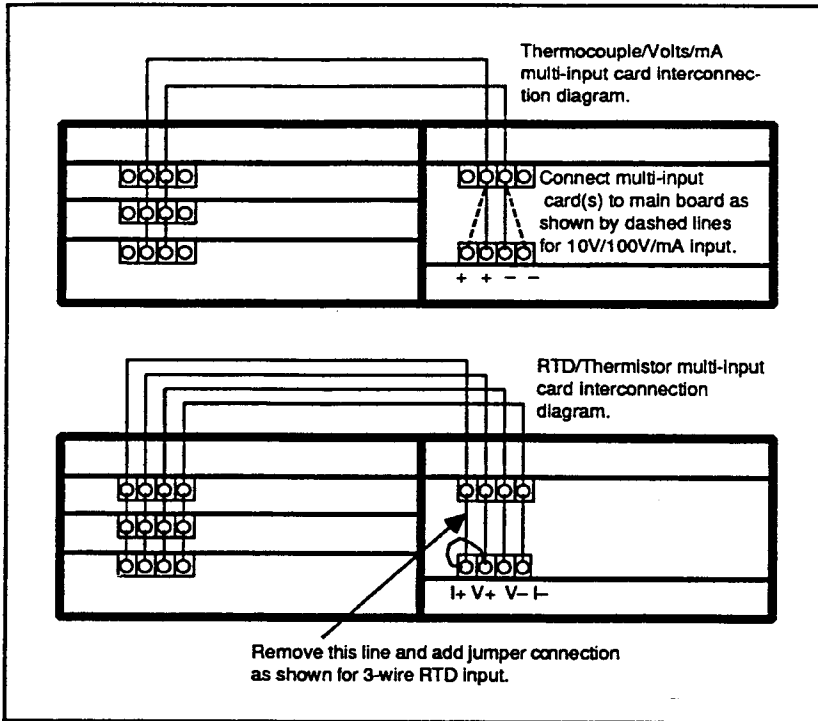

STEP 9. Wire output connectors (4-terminal connector) of all multi-input cards to main board input terminals. Refer to diagram above for multi-input card interconnection scheme.

NOTE

Use thermocouple extension wire of the appropriate type for the multi-input card interconnections if thermocouple inputs are used. The thermocouple lead colored red always goes to the minus (-) terminal.

STEP 10. Wire sensor inputs to input terminal blocks on multi-input card(s). See Figure 2-4 on page 2-6 for connection diagrams.

STEP 11. After wiring, reinstall upper rear panel to complete the installation if no other cards are to be installed. Route all wires to/from the indicator through the rear panel. This completes installation of this option.

2.9 INSTALLING THE DELTA INPUT OPTION

The Delta input option allows your indicator to accept a pair of inputs. One of these inputs or the difference value between these inputs can be shown on the display as selected by the option's front panel STEP key.

The Delta input option can be ordered from the factory separately. This is a two-part order which includes:

- (1) A 2- or 4-wire input Delta input card with quick disconnect terminal blocks, and...
- (2) New front panel lens assembly (with switches installed) and two front panel overlays, each of which shows a particular indicator model number.

A Delta input card uses quick disconnect terminal blocks that can be removed with wires still attached. This allows you to easily remove or swap a Delta card without the need to undo all the connections. To connect a wire, loosen the screw, insert the stripped lead into the terminal block and retighten the screw.

To remove all wiring from a Delta input card, pull the terminal blocks off.

Install the Delta input card in slot #3 as indicated in the drawing below. Your indicator accommodates one Delta input card only.

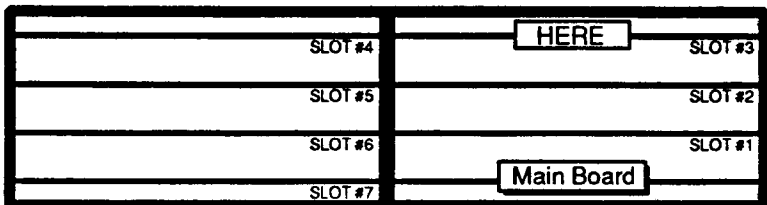
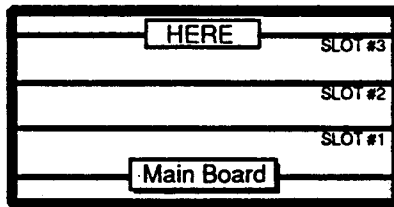

To install the Delta option, follow these steps:

CAUTION

To ensure proper operation of your indicator, always remove power before removing or installing any card.

STEP 1. Remove upper rear panel (two screws and washers).

STEP 2. Remove front panel lens (two screws) from indicator—unplug lens keyboard cable from display board. The removed lens assembly will be replaced by a new one in the kit.

STEP 3. Plug quick disconnect terminal blocks to Delta input card's header pins. Orient terminal blocks so that terminal numbers (1-4) are right side up.

STEP 4. Plug Delta input card in slot #3 (topmost) component side down. Keep in mind that a particular combination of option cards may limit the number of slots in which a given option can be installed. Review the "Points to Consider" information in 2.6.

STEP 5. After removing its backing, affix front panel overlay with your indicator model number (supplied in kit) to upper portion of new lens (see your old lens for reference).

STEP 6. Plug cable from front panel STEP key into 3-pin connector on Delta input card. As illustrated below, the Delta input card cable connector is accessible through the bezel cutout.

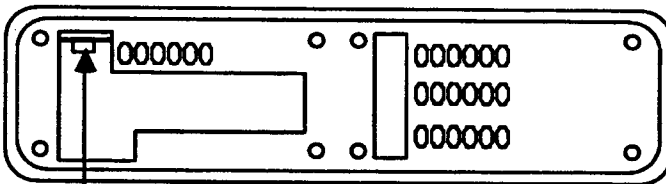

DOUBLE-WIDE UNIT SHOWN

Plug membrane switch connector to the Delta card's 3-pin connector.

STEP 7. Plug cable from main front panel keys into display board socket.

STEP 8. After plugging in all switches, attach lens assembly to bezel.

STEP 9. Wire output connector of Delta card to main board input terminals. Refer to drawing below for connections.

NOTE

Use thermocouple extension wire of the appropriate type for the Delta input card connection to the main board if thermocouple inputs are used. The thermocouple lead colored red always goes to the minus (-) terminal.

Delta Option Card Connections

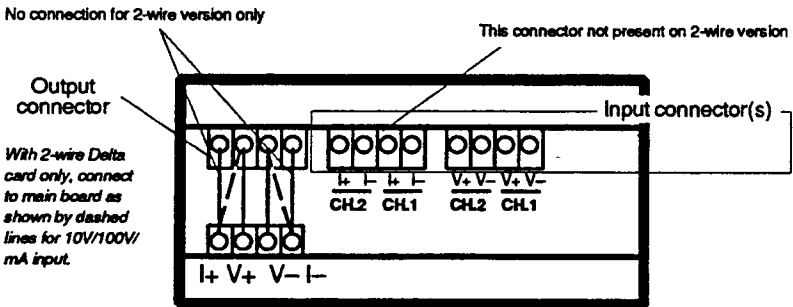

STEP 10. Wire sensor pair to input terminal blocks on Delta input card as shown in drawing above. Observe proper polarity and note channel assignment when connecting inputs: For difference readings, *channel 1 is the minuend and channel 2 is the subtrahend*. In other words, the channel 2 input value subtracted from the channel 1 input value equals the displayed difference value.

STEP 11. After wiring, reinstall upper rear panel to complete the installation if no other cards are to be installed. Route all wires to/from the indicator over the foam strip on the lower rear panel. This completes installation of this option.

2.10 INSTALLING THE DC POWER OPTION

The field-installable DC power option allows your indicator to operate from a DC power source. As shown in the drawing below, card slot #1 is the only slot in which the DC power option card is accepted.

NOTE

Your indicator has dual power capability with the DC power option installed. In case the primary (AC) power fails, the DC power option can take over to keep your indicator operating.

CAUTION

To ensure proper operation of your indicator, always remove power before removing or installing any card.

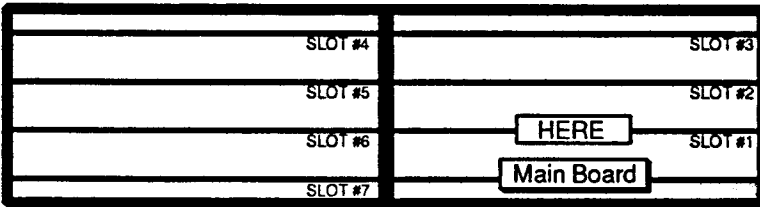
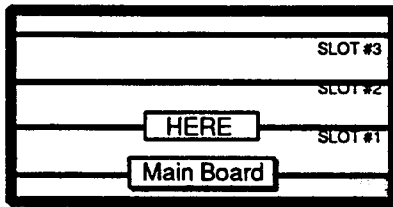

To install the DC power option, follow these steps:

STEP 1. Remove the upper rear panel; leave the lower rear panel in place. Make sure that the DC power option card is correctly configured for the voltage to be applied. To operate with a DC input in the range of 9–16 volts, the DC power option card must have jumpers installed in four places as shown in the drawing below. If the card is to be used with an input in the range of 18–32 volts, these jumpers must not be on the card.

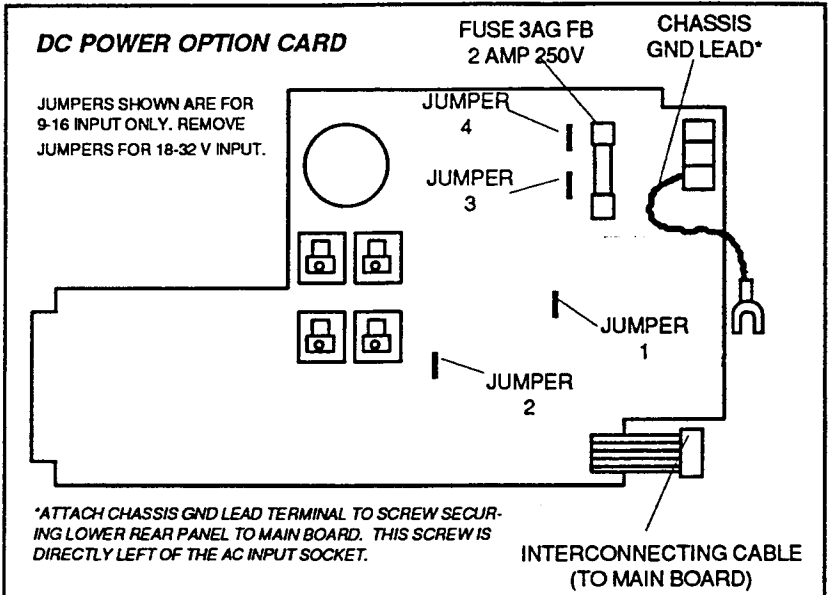

STEP 2. Plug the DC power option card into slot number #1 only, components facing up. With the card fully seated in its socket, bring the interconnecting cable (see drawing above) straight down over the rear edge of the card. Plug the cable connector to the pins behind the input screw terminals on the main board. Make sure the connector engages all pins.

STEP 3. Attach chassis ground lead terminal to rear panel screw per instructions in figure above.

STEP 4. Wire the DC power option card (refer to 2.4.2. for DC power hookup). Route the wires over the foam strip on the lower panel. If no other cards are to be installed, reinstall the upper rear panel. If you are using DC power exclusively, cover the AC connector opening in the lower rear panel with the self-adhesive cover plate supplied in the kit. This completes installation of this option. Removal of the option card is the reverse of installation.

CAUTION

When replacing the fuse, use the same fuse type (3AG Fast-Blo) and rating (250 V @ 2 Amps) to avoid potential electrical damage and fire hazard.

SECTION 3

OPERATION

3.1 INTRODUCTION

This section gives you the instructions on how to operate your indicator. Unless otherwise specified, the discussion applies to all models. Before placing your instrument in service, we recommend that you first read this section in order to familiarize yourself with its operation.

3.2 APPLYING POWER TO THE INSTRUMENT

Power is applied to your indicator as long as it is plugged into an active power source. There is no power ON/OFF switch. To remove power, unplug the power cord either from the instrument or power source outlet.

WARNING!

To eliminate shock hazard and/or possible instrument damage, always remove power before adding or removing any plug-in cards, and before rewiring the input.

When power is applied to the indicator, it will test itself for a few seconds to check the integrity of its memory and configuration. The indicator shows you this test-in-progress by displaying *SELFTEST*. If the indicator fails selftest, it will display one of these diagnostic messages:

| <i>SELFTEST DIAGNOSTIC MESSAGES</i> |
|---|
| <i>RAM BAD</i> – RAM memory bad, indicator cannot be used—requires repair. |
| <i>ROMx BAD</i> – ROM memory bad, indicator cannot be used—requires repair. Variable "x" is some hex number (4, 5, 6, 7, 8, 9, A, B) which pinpoints the faulty ROM chip (consult factory). |
| <i>continued...</i> |

RAM OUT – Ran out of RAM memory for the option cards installed, indicator cannot be used unless an option card is removed.

NVR OUT – Ran out of non-volatile RAM memory for the option cards installed, indicator cannot be used unless an option card is removed.

NO ALM 1 – Alarm option installed but no alarm card #1 address is detected. The Alarm option cannot be used unless you configure an alarm card for the alarm card #1 address.

NVR FAIL – Non-volatile RAM memory failed test. This is a result of one of two things, (1) the indicator has not been programmed, or (2) the NVR chip or circuit is not working properly to retain data. If the former is the case, program the indicator and use as normal. If the latter is the case, the indicator may be used but it will not retain programming or calibration data. Have the unit repaired as soon as possible.

BAD IRC – Input range card not installed, installed incorrectly, or has broken pin(s). The indicator cannot be used without a properly installed input range card.

3.3 MAIN FRONT PANEL KEYS AND DISPLAY

3.3.1 *The 14-segment LED Display*

Your indicator displays numerical and alphabetical data with its 14-segment LED display. Some of the information that can be displayed include:

- Selftest Errors
- Menu Items for Programming
- Programming Acknowledgement (pass/fail/accepted)
- Input Value (with 3-character unit of measure)
- Input Faults
- Alarm Conditions

We already mentioned above some of the messages the indicator can display in the selftest phase of operation. Another important display message you should be aware of is:

OVERLOAD

The "OVERLOAD" message is given whenever the measured input exceeds the input range or whenever a break is detected in a thermocouple input. A positive overload message is shown above. A negative overload is similar with the exception that it is given with the negative sign:

-OVERLOAD

3.3.2 *The Main Front Panel Keys*

Your indicator's major functions are controlled by the four front panel keys below the display. See Figure 3-1. Here's a brief description of the key functions:

- (1) PGM (Program) key – toggles the instrument between the program and process modes. Use the program mode to set or review the instrument's operating parameters. Use the process mode to process the input for display readout. Refer to 3.5 for the complete discussion on how to program the indicator.
- (2) UP Arrow key – generally used to increment a program selection. This key is also used in the process mode for some options.
- (3) DOWN Arrow key – generally used to decrement a program selection. This key is also used in the process mode for some options.
- (4) ENT (Enter) key – generally used to enter a program selection. This key is also used in the process mode for some options.

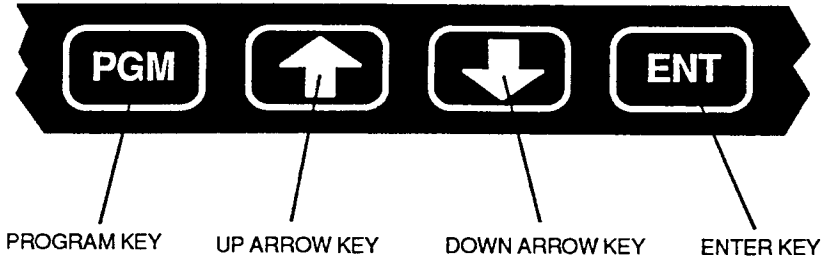

FIGURE 3-1. MAIN FRONT PANEL KEYS

3.4 MULTI-INPUT/DELTA INPUT STEP KEY AND LED INDICATORS

Multi-input indicator models have one, two, three, or four banks of sequentially numbered LED channel indicators on the front panel. Adjacent to each LED bank is a STEP key which controls the input selection indicated by that bank. Figure 3-2 shows you the front panel of an indicator with two banks of inputs (6 each).

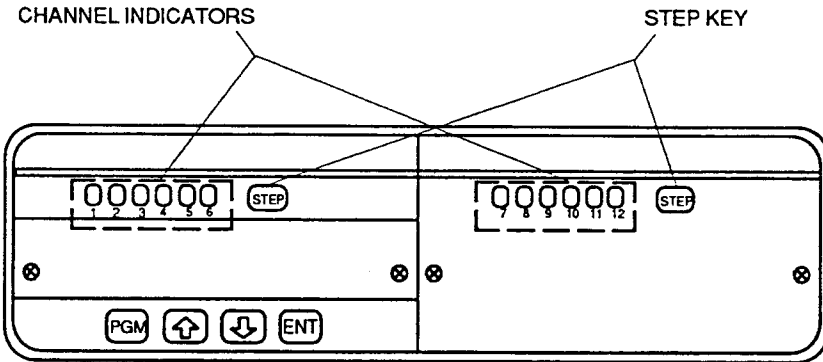
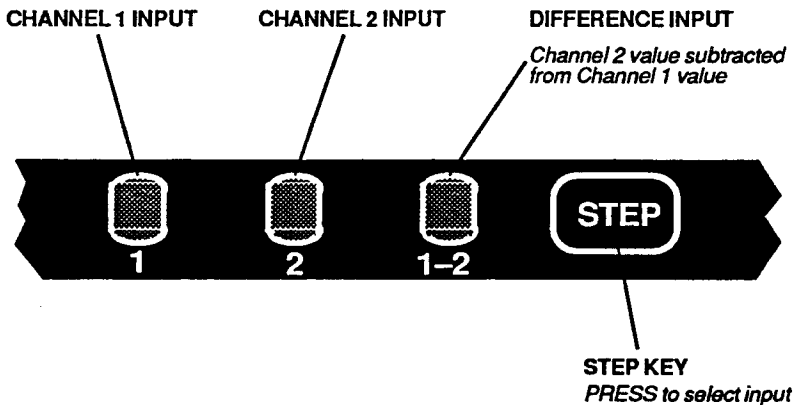

FIGURE 3-2. FRONT PANEL, TYPICAL MULTI-INPUT MODEL

Press the STEP key as required to select the input as indicated by the lit LED. With each press of the STEP key, an LED will light up from left to right on the bank to eventually wrap around to the first input. To select another bank's input, just press that bank's STEP key—an input will be selected on that bank as the input from the other bank is automatically deselected (LED OFF).

The Delta option's front panel STEP key and LED indicators are shown below. Press the STEP key as required to indicate the desired input as shown by the lit front panel LED. Like the multi-input option, each press of the STEP key steps to the next selection left to right on the front panel to eventually wrap around to channel 1.



When your indicator uses the multi-input or Delta input switch option, the display readout reflects the input selection as shown by the front panel channel indicator. This means that other options in the indicator such as the alarm, analog output, math, and scale and offset *will be dependent on the selected input including the Delta input difference value*. In other words, a switch option works on the input prior to option processing for alarm limit comparison, display, or data output.

3.5 PROGRAMMING YOUR INDICATOR—THE BASICS

3.5.1 Introduction

Your indicator is programmed by a menu-driven display which is operated by the four main front panel keys; you will be prompted on the display readout for some action to which you reply by pressing an arrow key or ENT key. You program the indicator by addressing main menu items as required. The main menu items that can be displayed are as follows:

1. INPUT
2. SCALING *
3. ALARM *
4. ANALOG *
5. MATH *
6. CALIB

The asterisked items are given only when the appropriate option card is installed in the indicator: scaling and offset card, alarm card, analog output card, math card. The addition (or subtraction) of any of these option cards automatically puts that option into (or out of) the main menu for programming.

WARNING!

You must observe the cardinal rule of power OFF before removing or adding any plug-in cards to avoid shock hazard and possible electrical damage. Observing this rule will also ensure correct indicator configuration whenever cards are added or removed.

With no option card installed at all, you will be given just the INPUT and CALIB menu items. Additional option cards will be available in the future, so the main menu item list above is subject to change.

3.5.2 Program Lock-out Switch

Your indicator has a program lock-out switch which is accessible behind the front panel lens (remove 2 screws). This switch is shown in Figure 3-3.

- Set program lock-out switch ON to *inhibit programming*.
- Set program lock-out switch OFF to *permit programming*.

Setting this switch ON will prevent unwanted change in the indicator's programming. With programming inhibited, the display will momentarily flash *PGM LOCK* whenever you place the indicator in the program mode. This is a reminder that the lock-out switch is set ON. You can make changes to the programming under this condition; however, the changes will not take effect unless the switch is set OFF (program unlocked) prior to re-entering the process mode.

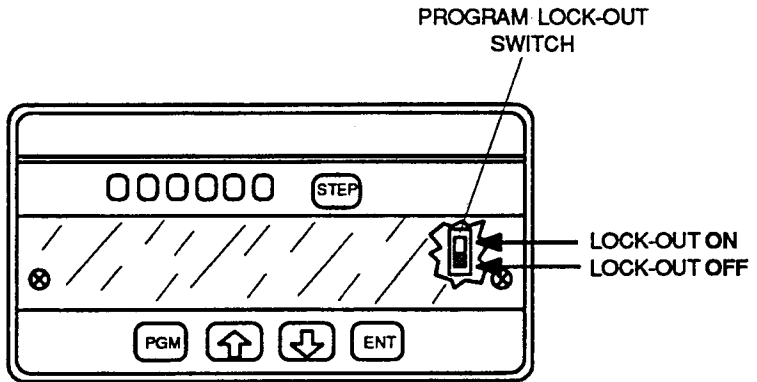

FIGURE. 3-3. PROGRAM LOCK-OUT SWITCH

Note that even with the lock-out switch set ON, you can still review the indicator's programming by stepping through the menu selections. All you have to do is enter the program mode and press the ENTER key repeatedly while observing the display. After completing review of the menu selections, press the PGM key to display again the input value. The indicator will show *PROCESS* for three seconds, then the input value.

3.5.3 Programming Steps Overview

Here's an overview on how to program the indicator:

STEP 1. Press PGM key. Note that once the indicator is in the program mode, you have a maximum of one minute between key presses before the indicator automatically switches back to the process mode. Completed

menu item changes will be in effect should the indicator switch itself to the process mode. However, note that if the indicator is switched (either automatically or manually) to the process mode with a menu item open for programming, any changes made to that menu item are discarded.

STEP 2. Step display to show main menu item you wish to program by using UP or DOWN arrow keys. By using only the arrow keys at this stage, you will be stepping through the main menu.

STEP 3. With desired main menu item on display, press ENT key to open item for programming.

STEP 4. Respond to prompt message by pressing UP or DOWN arrow key as required. To quit (exit) in the middle of programming a main menu item, press both arrow keys simultaneously—changes that were made to that main menu item will be cancelled as the indicator returns to the first main menu item (INPUT) for programming. Changes made to other main menu items are unaffected by the exit operation.

STEP 5. Press ENT key to enter your response. Depending on the menu item being programmed, you will then be given further prompting on the current menu item, or you will be presented with the next main menu item itself:

- Whenever you are prompted for an *input*, you have the option of using the arrow keys to change the programming or pressing the ENT key to keep the existing programming (if there's anything to keep).
- Whenever you are prompted with a *main menu item*, you have the option to open it for programming by pressing the ENT key, or bypassing it by pressing any arrow key.

When programming is finished for a main menu item, you will get a particular pass or fail message (except for input and alarm programming). If a fail message is shown, the previously programmed information for that particular menu item remains unchanged. The pass or fail message is shown for about two seconds after which the next main menu item is presented for programming.

STEP 6. After programming is finished, press PGM key to get out of program mode. (Remember, the indicator will get out of the program mode by itself if one minute passes without a key being pressed.) You will then be given a 2-second display of...

..*ACCEPTED* if the indicator accepts the programming. Or...

..*REFUSED* if the program lock-out switch is ON. Or...

..*PROCESS* if no changes were made in programming.

The input value then follows the display message on the readout.

NOTE

If a menu item is open for programming when the indicator is switched to the process mode, any changes made to that menu item are discarded. This applies to either manual or automatic switching to the process mode.

TERMINATING TIMED MESSAGES: Indicator programming time can be shortened by manually terminating the timed (2-second) messages. These messages include *PROGRAM*, *PASS CAL*, *FAIL CAL*, *4 MA =, 0 V =, 20 MA =, 10 V =, ALG PASS*, *ALG FAIL*, *INPUT1*, *DISPLAY1*, *INPUT2*, *DISPLAY2*, *SCL PASS*, and *SCL FAIL*. To terminate a timed message, just press any arrow key or the ENT key.

Note that the *ACCEPTED*, *BUSY*, and *PROCESS* messages cannot be manually terminated.

3.5.4 *Selecting the Input Range*

When you enter the program mode, the first menu item given is always *INPUT*—open this item for programming to select an input range. The type of input range card installed in your indicator determines the available ranges.

Note that whenever power is applied to your indicator, it checks for the type of input range card installed. If the input range card is a different type from the one previously installed, the indicator will erase *all* of its programming

and place itself in the program mode. You must then select an input range—the indicator cannot be placed in the process mode otherwise—and calibrate (*CALIB*) as required. You may also have to program other menu items as appropriate.

Follow these steps for input range selection:

STEP 1. Press PGM to enter program mode.

STEP 2. With display showing *INPUT*, press ENT key to open this menu item for programming.

STEP 3. Press any arrow key to step through the available range choices on the display readout.

STEP 4. With desired range on display, press ENT key to enter your selection.

If a thermocouple range was selected...

...you will be prompted next for a temperature scale.

Use any arrow key to display *DEG F* (degrees Fahrenheit), *DEG C* (degrees Celsius), or *KELVIN*.

With your choice of temperature scale on display, press the ENT key...

...you will then be prompted for the indicator's reference junction mode of operation.

Press any arrow key to display *RJ ENAB* (reference junction enabled) or *RJ DISAB* (reference junction disabled).

Most thermocouple applications require that you enable the indicator's reference junction. Disable the indicator's reference junction if reference junction compensation is to be provided externally.

With your desired reference junction mode of operation on display, press the ENT key and go on to step 5.

If an RTD range was selected...

...you will be prompted next for the hook-up scheme of your RTD input.

Press any arrow key to display *3-WIRE* or *4-WIRE* as appropriate for your application.

With your choice of 3- or 4-wire configuration on display, press the ENT key...

...you will then be prompted for a temperature scale.

Use any arrow key to display *DEG F* (degrees Fahrenheit), *DEG C* (degrees Celsius), or *KELVIN*.

With your choice of temperature scale on display, press the ENT key and go on to step 5.

If a thermistor range was selected...

...you will be prompted next for a temperature scale.

Use any arrow key to display *DEG F* (degrees Fahrenheit), *DEG C* (degrees Celsius), or *KELVIN*.

With your choice of temperature scale on display, press the ENT key and go on to step 5.

STEP 5. After choosing the input range, program other main menu items as required or just press the PGM key to exit the program mode and re-enter the process mode.

For the *Linear DC Voltage Input Card*, choose one of the following:

- 100 mV
- 1000 mV
- 10 V
- 100 V

For the *Linear Current Input Card*, choose one of the following:

- 4-20 mA
- 10-50 mA

For the *Thermocouple Input Card*, choose one of the following:

- J NBS
- K NBS
- T NBS
- E NBS
- R NBS
- S NBS
- B NBS
- N NBS
- C NBS
- G NBS
- D NBS
- CGI
- FECON (J DIN)
- CUCON (T DIN)

For the *RTD Input Card*, choose one of the following:

- PT1000
- PT100 (alpha385)
- PT100 (alpha392)
- PT200 (alpha392)
- CU10
- NI120

If an RTD range was selected...

...you will be prompted next for the hook-up scheme of your RTD input.

Press any arrow key to display *3-WIRE* or *4-WIRE* as appropriate for your application.

With your choice of 3- or 4-wire configuration on display, press the ENT key...

...you will then be prompted for a temperature scale.

Use any arrow key to display *DEG F* (degrees Fahrenheit), *DEG C* (degrees Celsius), or *KELVIN*.

With your choice of temperature scale on display, press the ENT key and go on to step 5.

If a thermistor range was selected...

...you will be prompted next for a temperature scale.

Use any arrow key to display *DEG F* (degrees Fahrenheit), *DEG C* (degrees Celsius), or *KELVIN*.

With your choice of temperature scale on display, press the ENT key and go on to step 5.

STEP 5. After choosing the input range, program other main menu items as required or just press the PGM key to exit the program mode and re-enter the process mode.

For the *Linear DC Voltage Input Card*, choose one of the following:

- 100 mV
- 1000 mV
- 10 V
- 100 V

For the *Linear Current Input Card*, choose one of the following:

- 4-20 mA
- 10-50 mA

For the *Thermocouple Input Card*, choose one of the following:

- | | |
|---------|-----------------|
| • J NBS | • N NBS |
| • K NBS | • C NBS |
| • T NBS | • G NBS |
| • E NBS | • D NBS |
| • R NBS | • CGI |
| • S NBS | • FECON (J DIN) |
| • B NBS | • CUCON (T DIN) |

For the *RTD Input Card*, choose one of the following:

- PT1000
- PT100 (alpha385)
- PT100 (alpha392)
- PT200 (alpha392)
- CU10
- NI120

For the *Thermistor Input Card*, choose one of the following:

- THERMS700 (YSI 700 series thermistors)
 - THERMS400 (YSI 400 series thermistors)
-

3.5.5 *Calibrating the Indicator*

Your indicator is designed to be calibrated in the field without the need for any potentiometer adjustments. This is made possible by a digital data comparison scheme which takes known inputs (zero and scale) for normalizing the slope as required to produce the correct readout value. The constants required to normalize the slope are stored in non-volatile memory—which means they remain even with power off.

Depending on the input range card used, all of the available ranges may be calibrated by calibrating one, three, or four ranges. The input range cards and their associated calibration values and range(s) are listed after the basic calibration procedure in this manual. Calibration basically consists of these three parts performed in sequence:

- (1) Zero
- (2) Span
- (3) Sensor calibration (optional)

For touch up calibration, you can calibrate for zero only. However, span cannot be calibrated unless you calibrate for zero first. The reason for this is that the effective span setting is dependent on the zero reading.

Sensor calibration—which is an optional part of the calibration menu—compensates for errors in an individual sensor. Perform sensor calibration only if it's required in your application.

Remember, if you change an input range card for another type, you must calibrate the indicator before you use it to guarantee performance within the specifications.

Here's a list of calibration equipment needed:

For the thermocouple and linear dc voltage ranges:

- Precision voltage source: resolution, 1 μV ; accuracy $\pm 0.1\%$ ($\pm 2 \mu\text{V}$).
- Interconnecting leads

For the current ranges:

- Precision current source: resolution, 1 μA ; accuracy $\pm 1\%$ ($\pm 2 \mu\text{A}$).
- Interconnecting leads

For the RTD and Thermistor ranges:

- Precision resistance decade box: resolution, .01 Ω ; accuracy $\pm 0.2\%$.
- Interconnecting leads, 4 each of same length and gauge.

Follow these steps for calibration:

STEP 1. Observing correct polarity, hook up calibrator source to indicator input terminals. Use the appropriate input sensor wiring scheme for the calibrator hookup. Refer to the instructions in 2.5 and the diagrams in Figure 2-4.

NOTE

To obtain the best calibration accuracy for RTD ranges, use the same connection scheme as the application, with the input programmed accordingly for 3- or 4-wire hook-up.

STEP 2. Enter program mode—open *CALIB* item for programming.

STEP 3. The display will now show *INSTRMNT*. At this stage, you can toggle to the *SENSOR* menu item by pressing any arrow key. However, to calibrate the indicator, press the ENT key with *INSTRMNT* on display.

STEP 4. You will then be prompted on the display for the zero input (for example, *SET 0MV*). Set calibrator source for this input.

STEP 5. Press ENT key to calibrate for zero. The display will show *BUSY* as it gathers readings and attempts to calibrate.

If calibration was successful, the message *PASS CAL* is displayed for about 2 seconds.

If calibration was unsuccessful, the message *FAIL CAL* is displayed for about 2 seconds after which you are again prompted for the zero input. Make sure that the indicator is receiving the proper zero input for the input type being calibrated—then try again. (If you wish to quit calibration at this point, press PGM key to get back to the process mode—indicator calibration will remain unchanged.)

STEP 6. After the *PASS CAL* message, you are then prompted on the display for the span input (for example, *SET 54MV*). Set the calibrator source to this input. Then press ENT key to calibrate for span. The display will show *BUSY* as it gathers readings and attempts to calibrate.

If calibration was successful, the message *PASS CAL* is displayed for about 2 seconds and both zero and span calibration is updated accordingly. You are then given the next main menu item for programming.

If calibration was unsuccessful, the message *FAIL CAL* is displayed for about 2 seconds after which you are again prompted for the span input. Make sure that the indicator is receiving the proper span input for the input type being calibrated—then try again. (If you wish to quit calibration at this point, press PGM key to get back to the process mode—only zero calibration will be updated.)

This completes full calibration for a particular range.

The calibration values required to calibrate all ranges on an input range card are listed on the next page. It's not really necessary to refer to this listing when calibrating your indicator since you will be prompted on the display for the appropriate input when you do the calibration. Recall, however, that some input range cards can be calibrated for all ranges if you calibrate any one range, while other input range cards are calibrated for all ranges only if you calibrate three or four specific ranges. The following shows you what each input range card requires for calibration:

THERMOCOUPLE INPUT CARD – Calibrate any one range (to calibrate all).

- ZERO input is 0.000 mV
- SPAN input is 54.000 mV

LINEAR DC VOLTAGE CARD – Calibrate all four ranges.

- ZERO input is 0.000 mV
- SPAN input is:
 - 60.000 mV for 100 mV range
 - .600 V for 1000 mV range
 - 6.000 V for 10 V range
 - 60.00 V for 100 V range

CURRENT INPUT CARD – Calibrate any one range (to calibrate all).

- ZERO input is 0.00 mA
- SPAN input is 20.00 mA

RTD INPUT CARD – Calibrate three ranges.

- ZERO input is 0 Ω
- SPAN input is:
 - 2.4 k Ω for PT1000 range
 - 675 Ω for PT100 (alpha385), PT100 (alpha392), PT200, and NI120 ranges—calibrating any one of these calibrates the others in this group.
 - 16 Ω for CU10 range

THERMISTOR INPUT CARD – Calibrate any one range (to calibrate all).

- ZERO input is an OPEN INPUT.
- SPAN INPUT is 150 Ω

3.5.5.1 *Sensor Calibration*

Sensor calibration is used to compensate for errors in the sensor. For example, if you have a thermocouple that reads 198 °C on the indicator display for a process that you *know* is 200 °C, then you calibrate the sensor to provide a 200 °C reading. The sensor calibration by the indicator does not simply tack on 2 counts to the value. Instead, it actually compensates the linearization table across the measurement range.

Because the need for sensor calibration varies with each individual sensor and the indicator's state of calibration, the sensor calibration is erased whenever you change the range or perform calibration. Check to see if your sensor needs calibration (see step 1 of the calibration procedure) if you change anything to cause the sensor calibration to be erased.

Before you perform sensor calibration, disable any options which give a modified display reading of the input value (for example, scale and offset, math option, etc.). This will allow the indicator to display an actual reading from the sensor.

Sensor Calibration Limits

You will get a *FAIL CAL* message after performing sensor calibration if:

(1) The difference between the desired value and the present measured value exceeds ± 100 display counts.

For example, if the present temperature reading is 198.3°, the indicator will accept a sensor calibration entry ranging from 188.3° minimum to 208.3° maximum since ± 100 display counts equals ± 10.0 degrees for this particular display reading.

(2) The display reads *OVERLOAD* (negative or positive).

(3) The desired display value is outside the acceptable limits.

Your entry for the desired display value must be within the limits as listed for the following sensor types:

Section 3 OPERATION

| <u>Input type</u> | <u>Min in F</u> | <u>Max in F</u> |
|-------------------|-----------------|-----------------|
| jnbs | + 311.6 | + 2006.2 |
| bnbs | + 899.5 | + 3179.6 |
| enbs | - 334.1 | + 1638.3 |
| knbs | - 276.0 | + 2463.0 |
| rnbs | + 32.0 | + 3183.1 |
| snbs | + 32.0 | + 3195.3 |
| tnbs | - 363.9 | + 750.0 |
| nnbs | + 32.0 | + 2115.1 |
| cnbs | + 32.0 | + 2106.3 |
| gnbs | + 163.5 | + 2111.6 |
| dnbs | + 32.0 | + 2062.7 |
| cgi | - 450.3 | + 32.0 |
| jdin | - 276.7 | + 1599.4 |
| tdin | - 256.4 | + 1080.7 |
| pt1000 | - 322.4 | + 737.9 |
| pt100 alpha385 | - 209.7 | + 1536.3 |
| pt100 alpha392 | - 383.8 | + 1456.6 |
| pt200 alpha392 | - 302.2 | + 1349.8 |
| ni120 | - 107.7 | + 603.9 |
| cu10 | - 63.4 | + 412.8 |
| thrms400 | - 34.80 | + 205.20 |
| thrms700 | - 25.00 | + 197.20 |

Follow these steps for sensor calibration:

STEP 1. Connect sensor to indicator. Expose sensor to known temperature, mV, V, mA, percent, etc. The sensor requires calibration if the indicator doesn't display this known value (this assumes that you've fully calibrated the indicator beforehand).

STEP 2. Press PGM to enter program mode.

STEP 3. Press arrow keys as required to display *CALIB*, then press ENT key to open this menu item for programming.

STEP 4. Press an arrow key to display *SENSOR*—open this item for programming by pressing ENT key. You will be entering the expected display reading in the following steps.

STEP 5. The first item you will be prompted on is the polarity of the expected display value. A plus sign (+) which indicates a positive value is initially shown. Press any arrow key to show the minus sign (–) which indi-

cates a negative value. With your choice of polarity on display (+ or -), press ENT key to enter your selection.

STEP 6. You will then be prompted for the expected display reading's numerical value. Set a number for each digit left to right as indicated by a blinking digit. Press any arrow key to increment or decrement the blinking digit. Once a number is chosen, press ENT key, then go on to the next blinking digit and set a number for it. If a digit is already what you want it to be, just press the ENT key and go on to the next digit. Continue on until *all* digits are entered.

You will then get a *PASS CAL* or *FAIL CAL* message, then the next main menu item for programming. If the sensor calibration was successful (*PASS CAL*), the display readout will now read the correct value when the indicator goes in the process mode.

Refer to "Sensor Calibration Limits" above if you get a *FAIL CAL* message.

3.6 USING THE SCALE AND OFFSET OPTION

The scaling and offset option is a linear function which takes the input value and scales it according to the scaling and offset values that you specify. This function is expressed by the equation:

$$mx + b = y$$

Setting up the scaling and offset option is easy because all you have to do is specify the input (x variable) and display output (y variable) at two known and convenient points (or coordinates). These points are:

- a low scale input (X1) and what the display should be at that point (Y1)...
- ...and a high scale input (X2) and what the display should be at that point (Y2).

Your indicator does the rest by calculating the slope (variable m, or gain) and Y intercept (variable b, or offset) required for the function.

Figure 3-4 diagrams the two coordinate points in scaling and offset.

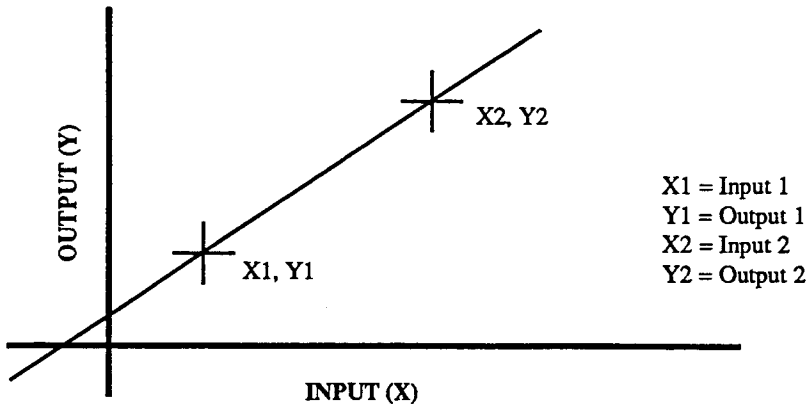

FIGURE 3-4. X AND Y COORDINATES FOR SCALING AND OFFSET

Follow these steps to program the scaling and offset option:

STEP 1. Press PGM to enter program mode.

STEP 2. Press arrow keys as required to display *SCALING*, then press ENT key to open this menu item for programming.

STEP 3. The first item you will be prompted for is your choice of having the scaling and offset option enabled or disabled. This is represented by the words *ON* or *OFF* respectively. Initially, this option is disabled so you will see *OFF* on the display when the *SCALING* item is first opened for programming. Press any arrow key to toggle between *ON* or *OFF*. With your *ON* or *OFF* choice on display, press the ENT key to continue.

NOTE

Previous scaling and offset programming is saved any time you disable the option (select *OFF*). To re-enable the scaling and offset, select *ON*, then press the ENT key throughout the *SCALING* menu sequence.

STEP 4. If you disable the option, you will be given the next main menu item for programming. If you enable the option, you are prompted next for an input value of *one of the coordinate points* by a 2-second *INPUT1* message.

The INPUT1 value may be that of the lower scale coordinate or upper scale coordinate. Normally, one would specify the lower scale coordinates first (X1,Y1) then the upper scale coordinates next (X2,Y2). However, you can also enter the coordinates into the indicator in reverse order (X2,Y2, then X1,Y1) with equally good results.

After the *INPUT1* message, you are prompted for the...

..INPUT1 Polarity.

Initially, the polarity is assigned positive so you will see "+" on the display. Press any arrow key to toggle between "+" and "-". With your + or - choice on display, press the ENT key to continue on to the...

..INPUT1 Numerical Value.

You must set a number for each digit left to right as indicated by a blinking digit to make up the INPUT1 value. Press an arrow key to increment or decrement the blinking digit. Once a number is chosen, press the ENT key, then go on to the next blinking digit and set a number for it. If a digit is already what you want it to be, just press the ENT key and go on to the next digit. Continue on until ALL digits are entered.

STEP 5. After entering the INPUT1 value, you are prompted for its corresponding display value by a 2-second *DISPLAY1* message. After the message, you are prompted for the...

..DISPLAY1 Polarity.

Set the DISPLAY1 polarity the same way you did the INPUT1 polarity. After setting the polarity, set the...

..DISPLAY1 Numerical Value.

Set this display value the same way you did the INPUT1 value. After *all* digits are entered, you will be prompted for the...

...Display Readout Decimal Point Placement.

This is shown by a blinking digit *and* decimal point to its right. The decimal point is initially in the same position as the input value. If this decimal point position is fine with you, just press the ENT key. If you want to change the position of the decimal point, press any arrow key to move the blinking digit/decimal point tandem as required. With the decimal point in the desired position as indicated by the blinking digit/decimal point, press the ENT key. This step sets the decimal point position for the scaled input's display readout. The other coordinate's display value will reflect the decimal point placement as set here.

STEP 6. After setting the display decimal point position, you are then prompted next for the input value of the *other coordinate point* by a 2-second *INPUT2* message. After this message, you are prompted for the...

...INPUT2 Polarity.

Set the INPUT2 polarity the same way you did the INPUT1 polarity. After setting the polarity, set the...

...INPUT2 Numerical Value.

Set this input value the same way you did the INPUT1 value.

STEP 7. After entering the INPUT2 value, you are prompted for its corresponding display value by a 2-second *DISPLAY2* message. After the message, you are prompted for the...

...DISPLAY2 Polarity.

Set the DISPLAY2 polarity the same way you did the INPUT1 polarity. After setting the polarity, set the...

...DISPLAY2 Numerical Value.

Set this display value the same way you did the INPUT1 value. Remember that the decimal point has already been set with the *DISPLAY1* entry. After entering the DISPLAY2 value...

STEP 8. Set the *3-character unit of measure* (engineering units) for the scaled input's display readout. You are prompted for this by the display reading *UNIT* with three characters to the right of which the first character is blinking. Press any arrow key to set the character—you have the numbers 0-9, a blank (displayed as an underscore "_" when programming) and all 26 letters of the alphabet from which to choose. Once a character is chosen, press the ENT key, then go on to the next blinking character and set a letter or number for it. Continue on until *all* characters are entered.

After entering the unit of measure, you will be shown a 2-second message of either...

...*SCL PASS* if the programming was valid, or...

...*SCL FAIL* if the programming was invalid.

If you make the mistake of entering one of the coordinates twice (maybe thinking that you entered the other one first) you will get a fail message at the end of the scaling programming. You will also get a fail message if your entered coordinates result in an out-of-bounds calculation (i.e. an offset or gain that the indicator can't accommodate).

Note that if the scale and offset programming attempt fails, its previous programming remains intact. After the pass or fail message, the next main menu item is presented on the display for programming. Your scale and offset programming takes effect once your indicator is in the process mode.

SCALE AND OFFSET EXAMPLES

Here's an example situation for which you would use the scaling and offset option:

Let's say that you would like to have the presently displayed information, in mV units, translated to engineering units of kPa (kilopascals). You know that 6.895 mV should be the equivalent of 1.00 kPa and that 68.950 mV is the equivalent of 10.00 kPa. Here's the data that you would have to enter in sequence:

| DISPLAY MESSAGE | YOUR INPUT |
|-----------------|------------|
| INPUT1 | +06.895 |
| DISPLAY1 | +001.00 |
| INPUT2 | +68.950 |
| DISPLAY2 | +010.00 |

You are then prompted with the currently displayed engineering units (MV) which you change to KPA (engineering units are displayed in capital letters). After changing the units, the indicator now takes the mV input and applies its calculated scale value and offset to display the appropriate kPa.

Using the Scale and Offset Option with Current Input

Instruments with the current input card accept 4-20 mA or 10-50 mA input which is *prescaled to display as 0.00-100.00 PCT (%)*. You must specify the input in terms of input percentage—not current—when rescaling the current input display with the scaling and offset option.

For example, to have a 4-20 mA input display as 0-1500 PSI (pounds/sq. inch), enter the following data in sequence:

| DISPLAY MESSAGE | YOUR INPUT | |
|-----------------|-------------|--------------|
| | RIGHT | WRONG |
| INPUT1 | +000.00 (%) | +004.00 (mA) |
| DISPLAY1 | +0000.0 | +0000.0 |
| INPUT2 | +100.00 (%) | +020.00 (mA) |
| DISPLAY2 | +1500.0 | +1500.0 |

After entering the DISPLAY2 value, change the current engineering units (PCT) to PSI.

3.7 USING THE ALARM OPTION

3.7.1 Introduction

The alarm option monitors the display value for an alarm condition by continuously comparing the displayed value with alarm limit values that you've programmed. (There are two limits per alarm card, two alarm cards max. per indicator for a total of four limits.) Each alarm limit has an associated relay which can be used to actuate various types of annunciating devices. Refer to the installation section of the manual for full details on the alarm card installation and hook-up.

When an alarm condition is detected, the appropriate relay is tripped and an alarm message alternates with the input value on the display. The alarm message is in the form:

ALRM sxx

where *ss* is either *HI* or *LO* and *x* is the limit number (1-4).

When more than one alarm condition is present, the alarms are given the priority of 1, 2, 3, and 4, with limit 4 being the highest and limit 1 being the lowest. Thus, the highest priority alarm will always be shown on the display.

Alarm option programming also includes your choice of an automatic or manual reset of the alarm card's relays. With automatic reset, a relay resets by itself once its associated limit is no longer exceeded. With manual reset, a relay is reset manually through a remote switch. The relay's alarm limit, however, must no longer be exceeded in order for the relay to be reset.

Note that alarm checking is only done in the process mode. As soon as you put your indicator in the program mode, alarm checking is stopped—any relays which were tripped because of an alarm will now become untripped.

It is also important to note that the alarm limit comparison is done against the display value. Keep in mind this fact if you are using the alarm option with the scaling and offset option or the math option. The latter two options give a display reading that's derived from the true input value.

3.7.2 Configuring the Alarm Card

The alarm card is configurable for:

- Address
- Relay mode of operation

Configure the alarm card to your application before placing it in service in your indicator. Configuration is set by three removable jumper jacks which plug onto terminal pins on the card. See the drawing below for the location of the alarm card's terminal pins.

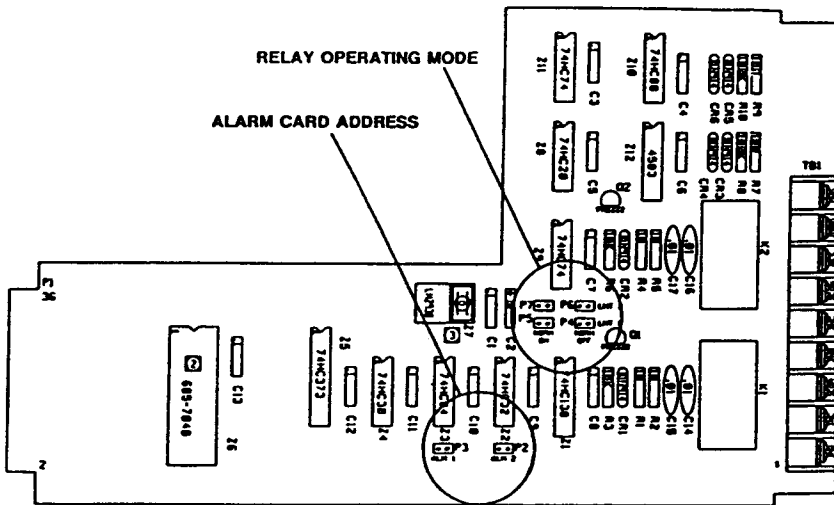

FIGURE 3-5. CONFIGURATION TERMINAL PINS, ALARM CARD

Configuration: Alarm Card Address

Two pair of pins, P2 and P3, are used to set the card address. A removable jumper jack is installed on one of these pairs (typically the P3 location):

- Place the jumper jack over the pins in the P3 location to configure the card for alarm card #1. The relays on the alarm card, K1 and K2, will then respond to limits #1 and #2 respectively.
- Place the jumper jack over the pins in the P2 location to configure the card for alarm card #2. The relays on the alarm card, K1 and K2, will then respond to limits #3 and #4 respectively.

If you are going to use only one alarm card, configure that card as alarm card #1. Your indicator allows use of a single alarm card only with the alarm card #1 address. To allow your indicator to use two alarm cards, configure one alarm card for alarm card #1 and the other for alarm card #2. The use of two alarm cards requires that you always configure one alarm card—and one only—as alarm card #1.

With factory installed alarm card(s), it isn't necessary for you to configure for address. However, if you have two factory installed alarm cards in your indicator, verify the address configuration in order to determine the relay/limit number relationship.

Configuration: Alarm Relay Operating Mode

You have the choice to have one or both relays on the alarm card to either energize or de-energize when tripped. A relay that de-energizes when tripped operates in the fail-safe mode. In the fail-safe mode, an unwanted loss of power naturally causes the relay contacts to drop out which in turn registers as an alarm trip by the system.

Two pin pairs (P4, P5 and P6, P7) are associated with each relay (K1 and K2 respectively). The operating mode of a particular relay is selected by jumpering one of the pin pairs with a jumper jack. The pin terminals and the associated relay operating mode is tabulated below:

| Relay Status | Relay Pins | |
|---------------------------|------------|----|
| | K1 | K2 |
| <i>Energize w/Trip</i> | P4 | P6 |
| <i>De-energize w/Trip</i> | P5 | P7 |

Let's say, for example, that you want both relays to de-energize when tripped (this means of course that both relays will be energized when not tripped). Looking at the table above, you can see that jumper jacks need to be installed on the P5 and P7 pins in order for both relays to de-energize on alarm.

The alarm card is supplied with the relay mode jumper jacks already on a pair of pin terminals. If you want to change the current relay mode configuration, pull the jumper jack(s) off the pins and reinstall on the alternate pair of pins as indicated in the table above.

3.7.3 Alarm Programming

Follow these steps to program the alarm option:

STEP 1. Press PGM to enter program mode.

STEP 2. Press arrow keys as required to display *ALARM*, then press ENT key to open this menu item for programming.

STEP 3. You are then prompted for a limit number to program (i.e. *LIMIT1*, *LIMIT2*, etc.). Press any arrow key to display your limit number choice, then press ENT key to open that limit number for programming.

STEP 4. Once you've selected a limit number you enable or disable that limit by defining it as *OFF*, *HI*, or *LO*: (If the math option is installed in your indicator, the alarm limit programming will have expanded menu choices for alarming on true input data or math data. Refer to the math option discussion in 3.9 for further information).

- Without prior programming, the limit is initially set OFF. A programmed limit will be saved if you set the limit OFF (a limit is ignored when set OFF). To re-enable a limit, just select HI or LO as appropriate (see below), then press the ENT key throughout the menu sequence.
- Select HI for a high alarm—a display value equal to or greater than the limit value will cause an alarm.
- Select LO for a low alarm—a display value equal to or lesser than the limit value will cause an alarm.

Press any arrow key to select (display) *OFF*, *HI*, or *LO*. Then press the ENT key to continue.

STEP 5. You are then prompted for the polarity of the alarm limit value. Initially, the polarity is assigned positive so you will see "+" on the display. Press any arrow key to toggle between "+" and "-". With your + or - choice on display, press the ENT key to continue.

STEP 6. After specifying polarity, set the alarm limit value itself. To make up the limit value, you will set a number for each digit left to right as indicated by a blinking digit. Press any arrow key to increment or decrement the blinking digit. Once a number is chosen, press the ENT key, then go on to the next blinking digit and set a number for it. If a digit is already what you want it to be, just press the ENT key and go on to the next digit. Continue on until *all* digits are entered.

STEP 7. After setting the limit value, use an arrow key to display your choice of an automatic reset (*AUTO RES*) or manual reset (*MAN RES*) for the alarm relays:

- With automatic reset, a relay will untrip by itself once the alarm limit is no longer exceeded.
- With manual reset, a relay will untrip only with a momentary closure of the alarm card's relay reset switch and only if the alarm limit is no longer exceeded.

With your choice of relay reset on display (*AUTO RES* or *MAN RES*), press the ENT key...

...If you selected *AUTO RES*, you will then be prompted for hysteresis. Go to the "Using Hysteresis" section of the manual for the discussion on how hysteresis works and its programming instructions.

...If you selected *MAN RES*, you will then be prompted for alarm delay. Go to the "Using Alarm Delay" section of the manual for the discussion on how alarm delay works and its programming instructions.

3.7.3.1 *Using Hysteresis*

Hysteresis (or deadband) is used to delay the return-to-normal condition of a tripped relay. Hysteresis is specified for your indicator's alarm limits in display count units. These units range 0-9 or 00-99 for 4- and 5-digit indicators respectively (a zero value specifies no hysteresis). Since hysteresis is given in display counts, the effective hysteresis value depends on your input range selection. For example, when using a thermocouple range, a limit with a hysteresis of "8" means that the display value must return within the exceeded limit by over 0.8° for a 5-digit indicator model or 8° for a 4-digit indicator model before the alarm is cleared (relay reset).

Hysteresis units automatically assume negative values for HI limits and positive values for LO limits. To get a better idea on what hysteresis can do for you, refer to the table below. This table shows you how a hysteresis value of "6" would affect the alarm condition for HI and LO alarm limits in a 4-digit indicator model.

Hysteresis set at 60

| ALARM LIMIT | READING | ALARM ? |
|-------------|-------------|---------|
| HI +0100.0 | 100.0 | YES |
| | 99.9–94.0 | YES |
| | 93.9 | NO |
| LO +0100.0 | 100.0 | YES |
| | 100.1–106.0 | YES |
| | 106.1 | NO |

Setting Hysteresis

You are prompted for hysteresis with *HYST x* (for 4-digit indicators) or *HYST xx* (for 5-digit indicators) on the display—where *x* is some number between zero and nine. Enter the hysteresis value (0-9 or 00-99 as appropriate) the same way you did the limit value (use an arrow key to set a number for the blinking digit). Once you enter your hysteresis value, you will then be prompted for the alarm delay. Go to the "Using Alarm Delay" section of the manual for the discussion on how alarm delay works and its programming instructions.

3.7.3.2 Using Alarm Delay

Alarm delay holds off an alarm trip until the alarm condition exists for a specified period of time (in seconds). Use alarm delay whenever you have a noisy or unstable input signal. By filtering out short duration alarm conditions, alarm delay will prevent annoying and unnecessary alarm indications from occurring.

Setting Alarm Delay

You are prompted for alarm delay with *DELAY x* on display—where *x* is some number between zero and nine, representing time in seconds. Use an arrow key to select a number (0-9) for the blinking digit, then press the

ENT key to enter the value. Give a value of zero (0) if you want no alarm delay. Programming for a particular limit number is complete after setting the alarm delay. Follow steps 2 through 7 to program additional alarm limits as required.

3.8 USING THE ANALOG OUTPUT OPTION

The analog option card allows you to translate your indicator's display reading to a proportional analog output signal. There are two versions of the analog output option card. One is a current output device and the other is a voltage output device. Both are programmed in the same manner.

Note that the analog output is given only in the process mode. As soon as you put your indicator in the program mode, the analog output goes to its zero value output.

Follow these steps to program the analog output option:

STEP 1. Press PGM to enter program mode.

STEP 2. Press arrow keys as required to display *ANALOG*, then press ENT key to open this menu item for programming.

STEP 3. After opening the menu item, the display will show:

...*ON* (analog output option enabled) or...

...*OFF* (analog output option disabled) or...

...*FULL SCL* (fixed full scale analog output)

Initially, the analog output option is disabled so you will see *OFF* on the display when the *ANALOG* item is first opened for programming. Press any arrow key to display the desired option status.

NOTES

Previous analog output option programming is saved any time you disable the option (select *OFF*). To re-enable the scaling and offset, select *ON*, then press the ENT key throughout the *ANALOG* menu sequence. *Also...*

If you have the math option installed in your indicator, the analog output programming will have expanded menu choices for having the output scaled either on the true input data or math data. Refer to the math option discussion in 3.9 for further information.

Selecting *FULL SCL* causes the analog output option to give a fixed full scale output signal once the indicator is in the process mode. This signal is used to calibrate the analog option's full scale output and also to calibrate the device to which the analog output option is connected. Refer to the *ANALOG OUTPUT CALIBRATION* discussion.

STEP 4. With your choice of *ON*, *OFF*, or *FULL SCL* on display, press the ENT key. You will get the next main menu item for programming if you chose *OFF* or *FULL SCL*. If you chose *ON*...

STEP 5. A 3-second message will be given prompting you for the display value that gives the minimum output:

4 MA = (for current analog output option)

or

0 V = (for voltage analog output option)

Note that you can scale the display reading with a $\pm 9999(9)$ display counts range regardless of the input range used. This gives you the capability to provide a portion of the 4-20 mA or 0-10 V span as the minimum and maximum output values. After the 2-second message, you are prompted for the...

...Polarity of the Display Value giving Minimum Output.

Initially, the polarity is assigned positive so you will see "+" on the display. Press any arrow key to toggle between "+" and "-". With your + or - choice on display, press the ENT key to continue on to the...

...Numerical Value of the Display giving Minimum Output.

You must set a number for each digit left to right as indicated by a blinking digit to make up the desired display value which gives the minimum output. Press any arrow key to increment or decrement the blinking digit. Once a number is chosen, press ENT key, then go on to the next blinking digit and set a number for it. If a digit is already what you want it to be, just press the ENT key and go on to the next digit. Continue on until *all* digits are entered.

STEP 6. A 3-second message will then be given prompting you for the display value that gives the maximum output:

20 MA = (for current analog output option)

or

10 V = (for voltage analog output option)

After this message, you are prompted for the...

...Polarity of the Display Value giving Maximum Output.

Set the polarity of the display value giving maximum output the same way you did the display value giving minimum output. After setting the polarity, set the...

...Numerical Value of the Display giving Maximum Output.

This is the display value that will correspond to the 20 mA or 10 V analog output. The display value can be your choice of a high scale or low scale display reading within the input range. Set this display value the same way you did the display value giving minimum output.

After entering the value of the maximum display, you will be shown a 2-second message of either...

...*ALG PASS* if the programming was valid, or...

...*ALG FAIL* if the programming was invalid.

If you make the mistake of entering a display value twice, you will get a fail message at the end of the analog output programming. You will also get a fail message if your entered display values result in an out-of-bounds calculation (i.e. an offset or gain that the indicator can't accommodate).

Note that if the analog output programming attempt fails, its previous programming remains intact. After the pass or fail message, the next main menu item is presented on the display for programming. Your programmed analog output takes effect once your indicator is in the process mode.

3.8.1 *Analog Output Calibration*

You should check the analog output periodically to see whether calibration is required. Follow these steps to check and adjust (if required) the analog output:

STEP 1. With power off, remove the indicator rear panel.

STEP 2. Apply power to the indicator and place it in the program mode.

STEP 3. Connect a 4 1/2 digit DVM to the analog output terminals (observe correct polarity). Select the proper DVM range (volts or milliamps) as required.

STEP 4. The DVM should read 0.000 V \pm 0.002 V for the voltage output or 4.000 mA \pm 0.004 mA for the current output. If the output is out of tolerance, adjust R15 (see Figure 2-7) for the correct reading on the DVM. This takes care of the zero output.

STEP 5. Now select the *ANALOG* menu option and enter the *FULL SCL* menu option, then place the indicator in the process mode (press PGM key).

STEP 6. The DVM should read 10.000 V ± 0.027 V for the voltage output or 20.000 mA ± 0.044 mA for the current output. If the output is out of tolerance, adjust R11 (see Figure 2-7) for the correct DVM reading. This takes care of the full scale output.

Use the calibrated full scale signal to calibrate, as required, the device receiving the analog output signal (refer to the manufacturer's instructions).

3.9 USING THE MATH OPTION

3.9.1 Introduction

The math option processes the input value with one of four mathematical functions and displays the result on the readout. The available math functions are:

- Maximum
- Minimum
- Time Average
- Rate of Change

The following discussion explains the process involved for each of the math functions:

Maximum. The maximum (max) computation monitors the input value and holds the maximum reading on display. The displayed max value is computed by continuously comparing the current input value against the existing (displayed) max value. If the current value is greater than the existing max value, the existing max value is replaced with the current value. This value then becomes the new displayed max value.

The displayed max value can be the maximum value since:

- the indicator was reset (i.e. power fail or watch dog) or...
- the math option was reprogrammed for MAX or...

- the math option was reset (manual reset starts the math process anew—refer to 3.9.2).

If the max computation is used, *MAX* is shown on the display as the engineering units for the maximum value.

Note that a positive overload (displayed as *OVERLOAD*) is not considered a maximum value. Your indicator will display positive overload if it is indeed in that state. However, it will not store a positive overload value as a max value. Instead, the maximum non-overload value will be displayed once the input returns from a positive overload condition.

Minimum. The minimum (min) computation monitors the input value and holds the minimum reading on display. The displayed min value is computed by continuously comparing the current input value against the existing (displayed) min value. If the current value is less than the existing min value, the existing min value is replaced with the current value. This value then becomes the new displayed min value.

The displayed min value can be the minimum value since:

- the indicator was reset (i.e. power fail or watch dog) or...
- the math option was reprogrammed for MIN or...
- the math option was reset (manual reset starts the math process anew—this is explained 3.9.2).

If the min computation is used, *MIN* is shown on the display as the engineering units for the minimum value.

Note that a negative overload (displayed as *-OVERLOAD*) is not considered a minimum value. Your indicator will display negative overload if it is indeed in that state. However, it will not store a negative overload value as a min value. Instead, the minimum non-overload value will be displayed once the input returns from a negative overload condition.

Time Average. The time average computation gives you a running average of the input value over a selected time interval (1-60 seconds). The mathematical transfer function is:

$$\frac{i_1 + i_2 + i_3 + i_4 + \dots + iT}{T} = A$$

- Where: i = input reading
- T = number of readings within the specified time interval
- A = average input value over the specified time interval

To illustrate how this works, let's say that we want to have the average input value shown over a 30-second period of time. There are typically 60 readings in a 30-second period. In this case then, our displayed average will be the sum of the 60 readings (4520, let's say) divided by the number of readings, 60:

$$4520 \div 60 = 75.333 \text{ (average reading)}$$

For our example, the indicator's average reading over a 30-second period is 75.333. The average values are rounded to accommodate the indicator's measurement resolution. This means that our example result might be displayed as 75 *AVG* or 75.3 *AVG*. (If the time average computation is used, *AVG* is shown on the display as the engineering units for the time average value.)

When time average is first used or reset, the display will show the average reading up to the maximum number of readings in the specified time period. In other words, using our example above, the display will first show the average of two readings, then the average of three readings, then the average of four readings, etc.... continuing on to the average of 59 readings after which the average shown is always made up of 60 readings.

Note that the displayed average is a running average. When the maximum number of readings in the specified time interval is accumulated, the newest reading is always added to the average while the oldest reading is discarded.

Rate of Change. Instead of averaging readings over a period of time as explained in TIME AVERAGE above, the rate of change computation averages the *difference* between consecutive readings over a selected time interval (1-60 seconds) to yield the rate of change per minute or second. The mathematical transfer function is:

$$\frac{(i_2 - i_1) + (i_3 - i_2) + (i_4 - i_3) + \dots + (i_{T+1} - i_T)}{T} \times F = R$$

Where: i = input reading

T = number of readings within the
specified time interval

F = normalizing factor (varies depending on
input range and sec/min selection)

R = Rate of Change

To illustrate how this works, let's say that we want to have the input rate of change shown over a 5-second interval, displayed in units per second. There are typically 10 readings in a 5-second period. In this case then, our displayed rate of change will be the sum of 10 difference readings (33, let's say) divided by 10 readings multiplied by a normalizing factor which happens to be 2:

$$33 \div 10 \times 2 = 6.6 \text{ (rate of change reading)}$$

For our example, the indicator's average change over a 5-second period is 6.6. The average values are rounded to accommodate the indicator's measurement resolution. This means that our example result might be displayed as 7 /SC or 6.6 /SC. (For the rate of change value, /SC or /MN is shown on the display as per second or per minute units respectively.)

When rate of change is first used or reset, the value will reflect readings up to the maximum number of readings in the specified time period. In other words, using our example above, the display will first show the rate of change over two readings, then the rate of change over three readings, then the rate of change over four readings, etc... continuing on to the rate of change over 9 readings after which the rate of change shown is always made up from 10 readings.

Note that the displayed rate of change uses a running average. When the maximum number of readings in the specified time interval is accumulated, the newest reading is always added to the average while the oldest reading is discarded.

3.9.2 *Resetting the Math Option*

A running math computation can be made to start anew at any time by manually resetting it. Reset the math process by pressing the two front panel arrow keys simultaneously while in the process mode. The reset function is also available as a menu item when setting up the math option.

3.9.3 *Switching the Display Between Math Value and True Input Value*

When the math option is enabled and the indicator is in the process mode, the display normally shows a value as determined by the math function you selected. Press the ENTER key to switch the display between the math computed value and the true (unprocessed) input value. Each press of the ENTER key will toggle the display to the alternate mode. No computational information is lost when using this feature.

3.9.4 *Programming the Math Option*

Follow these steps to program the math option:

STEP 1. Press PGM to enter program mode.

STEP 2. Press arrow keys as required to display *MATH*, then press ENT key to open this menu item for programming.

STEP 3. The first item you will be prompted for is your choice of having the math option enabled, disabled, or reset. This is represented by the words *ON*, *OFF*, and *RESET* respectively. Initially, this option is disabled so you will see *OFF* on the display when the *MATH* item is first opened for programming. Press any arrow key to choose between *ON*, *OFF*, or *RESET*. With your choice on display, press the ENT key to continue.

NOTE

Previous math programming is saved any time you disable the option (select *OFF*). To re-enable the math, select *ON*, then press the ENT key throughout the menu sequence.

STEP 4. If the option was disabled or reset, you will be given the next main menu item for programming. If you enabled the option, the display prompts you with one of the four math functions available: (1) *MAX*, (2) *MIN*, (3) *TIME AVG*, or (4) *RATE CHG*. Press any arrow key to display the math function you wish to use. Then press the ENT key to enter that selection.

STEP 5. If *MIN* or *MAX* was entered, you will be given the next main menu item for programming. If you entered *TIME AVG* or *RATE CHG*, the display prompts you for a 2-digit time interval (in seconds)...

...You must set a number for each digit left to right as indicated by a blinking digit to make up the time interval value—a valid interval is in the range 01-60. Press an arrow key to increment or decrement the blinking digit. Once a number is chosen, press ENT key, then go on to the next blinking digit and set a number for it. If a digit is already what you want it to be, just press the ENT key and go on to the next digit. Continue on until *all* digits are entered.

STEP 6. If the rate of change function was selected, the display will show */SEC* or */MIN* (per second or per minute) after entering the time interval. This is your prompt to select the rate of change units. Press any arrow key to toggle to the alternate selection as required. With your */SEC* or */MIN* choice on display, press the ENT key.

STEP 7. After entering the time interval digits or rate of change units, you will be given a 2-second display message of *MATHPASS* or *MATHFAIL*, then the next main menu item for programming:

- The *MATHPASS* message is given when a valid time interval is entered, i.e., within the range 01-60.
- The *MATHFAIL* message is given when an invalid time interval is entered, i.e., a value of zero or a value over 60.

Note that if the math option programming attempt fails, its previous programming remains intact. Your math programming takes effect once your indicator is in the process mode.

Using the Math Option with the Alarm and/or Analog Output Option(s)

With the math option installed in your indicator, you can choose either the *math value* or the *true data* as the basis for (1) alarm limit comparison and/or (2) output scaling for the analog output option. As such, the menu prompts for setting the alarm limits and enabling the analog output option are as follows:

ALARM OPTION: Enable a limit by choosing...

HI DATA (a true data value equal to or greater than the limit value will cause an alarm) or...

LO DATA (a true data value equal to or lesser than the limit value will cause an alarm) or...

HI MATH (a math value equal to or greater than the limit value will cause an alarm) or...

LO MATH (a math value equal to or lesser than the limit value will cause an alarm).

Note that limits are individually assigned as operating on math data or true input data.

If the math option is turned off via menu programming, any alarm limit operating on math is still compared to the last math value prior to being turned off. For example if the math option is turned off with a math alarm limit exceeded, that limit will still be in alarm even if the displayed data is within the limit. If you turn the math option off, we suggest that you turn off the math alarm limits, or else change the math alarm limits to data alarm limits as required.

If the math card is removed, any alarm limit operating on math data is automatically turned off. The programmed numerical value still *remains* but the limit will be on *data* if turned on.

ANALOG OUTPUT OPTION: Enable the analog output option by choosing...

ON DATA—to scale the analog output on the true data value—or...

ON MATH—to scale the analog output on the math value.

If the math option is turned off via menu programming, the analog output, if selected for math, will be at a fixed level as determined by the math value prior to being disabled.

If the math card is removed, the analog output, if selected for math, will be turned off automatically.

NOTES:

(1) With the math card not installed in the indicator, the menu prompts for the alarm and/or analog output options will be presented as described in the basic option programming instructions—in other words, no choices for math or data are given.

(2) An input in overload is not a valid input for math processing since it doesn't contribute to any math computation. However, if the input is in

overload, it is indicated as such on the display. In an overload condition, an alarm limit assigned to math will default to data—an alarm may trip or un-trip on overload depending on the HI/LO limit assignment and the polarity of the overload. Similarly, the analog output scaling will default to data if assigned for math—the output will go full scale, the direction depending on the polarity of the overload. When the input comes out of overload, math processing picks up where it left off before the overload condition occurred. The alarm option and/or the analog output option then operate on the math or data selection as appropriate.

3.10 USING THE SERIAL OUTPUT OPTION

3.10.1 *Introduction*

The serial output option is used for serial transmission of data as given on the indicator's display readout. Receiving devices can be any computer or peripheral device with an RS-232C or 20 mA current loop I/O port. A hardware watch dog circuit checks the serial output operation continuously. Should the serial data flow be interrupted due to a hardware or software fault, the system will restart itself automatically.

Configure the serial output card to your application before placing it in service in your indicator. Refer to the next section for configuration instructions.

3.10.2 Configuring the Serial Output Card

The serial output card is configurable for:

- Operating mode: RS-232C or 20 mA current loop (Active or Passive)
- Baud rate
- Character format
- Device number
- Termination characters

Configuration is set by the serial output card's two removable jumper jacks (which plug onto terminal pins on the card) and two miniature DIP (Dual Inline Package) switch assemblies. See the drawing below for the location of the terminal pins and DIP switches.

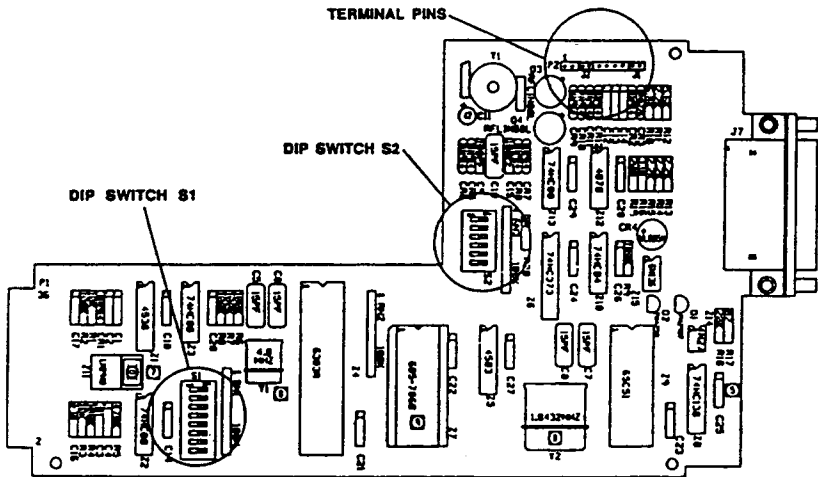

FIGURE 3-6. TERMINAL PINS AND DIP SWITCHES, SERIAL OUTPUT CARD

Configuring the Serial Output Card for Operating Mode

Ten pins (J2) are used to determine the serial output card's operating mode. In the drawing above, pin 1 is the leftmost pin, so the order is one through ten left to right. Select the desired operating mode by placing two jumper jacks over two pair of pins as indicated in the table below:

| To Select: | Place Jumpers on Pin Pairs |
|----------------|----------------------------|
| 20 mA, Passive | 9,10 3,4 |
| 20 mA, Active | 5,6 1,2 |
| RS-232C | 7,8 1,2 |

Configuring the Serial Output Card for Baud rate/Character format/Device number/Termination characters

The serial output card uses two DIP switch assemblies for configuration. These switches will be one of two general types, a *rocker* switch or *slide* switch. Regardless of the type, each individual switch will have two positions. Look at the face of the switch assembly right side up (lettering and/or numbering clearly readable):

- To set a switch to the **CLOSED/ON** position...
 - ...push the switch down at the top (rocker switch)
 - ...or slide the switch towards the top (slide switch).

- To set a switch to the **OPEN/OFF** position...
 - ...push the switch down at the bottom (rocker switch)
 - ...or slide the switch towards the bottom (slide switch).

Switch S1—Baud Rate and Character Format

Set switch S1 for the baud rate and character format as required for your application per the tables below. Note that an "X" indicates an OPEN/OFF switch and an "O" indicates a CLOSED/ON switch.

S1 1 2 3 4 5 6 7 8
 baud *word* *stop* *parity*

| BAUD RATE | | | |
|-----------|---|---|------|
| 1 | 2 | 3 | Rate |
| O | O | O | 300 |
| X | O | O | 600 |
| O | X | O | 1200 |
| X | X | O | 1800 |
| O | O | X | 2400 |
| X | O | X | 3600 |
| O | X | X | 4800 |
| X | X | X | 9600 |

| WORD | | |
|------|---|----------|
| 4 | 5 | Bit Size |
| O | O | 8 bits |
| X | O | 7 bits |
| O | X | 6bits* |
| X | X | 5 bits* |

| PARITY | | |
|--------|---|-------------|
| 7 | 8 | Condition |
| O | O | no parity |
| X | O | odd parity |
| O | X | no parity |
| X | X | even parity |

| STOP BITS | |
|-----------|----------|
| 6 | Qty Bits |
| O | 1 bit |
| X | 2 bits |

* These bit sizes aren't normally used since it results in truncated characters. Data is transmitted out the serial port using 7-bit ASCII characters.

NOTE

If a word size of 8 is selected at 300 baud, the data is forced to *no parity* and *1 stop bit* regardless of the DIP switch settings. This is done to meet the transfer rate required to keep up with the reading's 1/2 second conversion time.

Switch S2—Device Address and Termination Characters

Your indicator must be assigned a unique address—a number between 00 and 16—in order to identify the data. Termination characters are used to control a cursor or printing mechanism at the end of the transmitted data.

Set switch S2 for the device address and data termination characters as required for your application per the tables below. Note that an "X" indicates an OPEN/OFF switch and an "O" indicates a CLOSED/ON switch.

S2 1 2 3 4 5 6
 device *terminator*

| Device Address | | | | |
|----------------|---|---|---|----|
| 1 | 2 | 3 | 4 | # |
| O | O | O | O | 01 |
| X | O | O | O | 02 |
| O | X | O | O | 03 |
| X | X | O | O | 04 |
| O | O | X | O | 05 |
| X | O | X | O | 06 |
| O | X | X | O | 07 |
| X | X | X | O | 08 |

| Device Address | | | | |
|----------------|---|---|---|----|
| 1 | 2 | 3 | 4 | # |
| O | O | O | X | 09 |
| X | O | O | X | 10 |
| O | X | O | X | 11 |
| X | X | O | X | 12 |
| O | O | X | X | 13 |
| X | O | X | X | 14 |
| O | X | X | X | 15 |
| X | X | X | X | 16 |

| Termination Characters | | |
|------------------------|---|--------------------|
| 5 | 6 | Characters |
| O | O | Space, Space |
| X | O | Space, CR (return) |
| O | X | CR, LF (line feed) |
| X | X | Space, LF |

3.10.3 Serial Output Data Format

The RS-232 data output is controlled by changing the state of the serial output card's CTS line (see pinout diagram of connector in 2.6.5). Drive the CTS line low to cease data transmission from the serial output card. Note that partial transmission of the character may occur when CTS is driven low, causing garbage to be received by the receiving device. If the CTS line is brought high again within 1/2 second, transmission will continue with the next character. If more than 1/2 second has passed, transmission will resume at the first character of the current reading.

Serial output data is transmitted in fixed format 15-character ASCII packets. Each data packet is transmitted as follows:

- The first two characters are the tens and ones digits which form the device address (01 to 16—refer to serial output card configuration instructions).
- The third character is always a space.
- The following ten characters vary according to content (this is illustrated below).
- The last two characters are the termination characters (refer to serial output card configuration instructions).

NORMAL DATA

Here's how normal data is output (datastream):

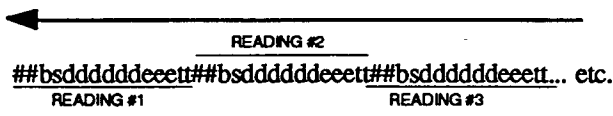

Where:

- # = device address digit
- b = space (blank)
- s = polarity sign: positive (blank) or negative (-)
- d = digit data (with embedded decimal point)
- e = engineering units character
- t = terminator character

Example Data:

01 -234.56PCT(cr)(lf) ...indicator #1 has a reading of -234.56 %—each reading is terminated with a CR/LF (carriage return/linefeed).

14 0.013 MV(sp)(cr) ...indicator #14 has a reading (positive) of 0.013 mV—each reading is terminated with a space and CR.

OVERLOAD DATA

Here's how overload data is output (datastream):

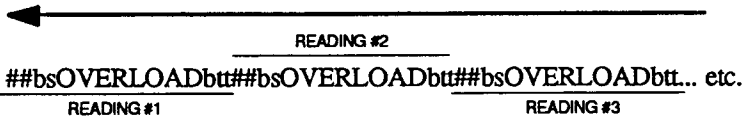

Where:

- # = device address digit
- b = space (blank)
- s = polarity sign: positive (blank) or negative (-)
- t = terminator character

Example Data:

09 -OVERLOAD (sp)(lf) ...indicator #9 has a negative overload reading—each reading is terminated with a space and LF (linefeed).

12 OVERLOAD (sp)(sp) ...indicator #12 has a positive overload reading—each reading is terminated with two spaces.

ALARM DATA

Here's how alarm data is output (datastream):

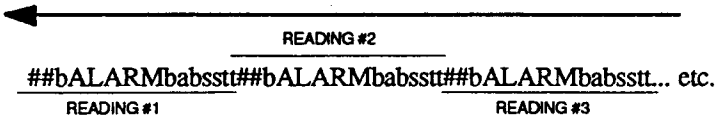

Where:

- # = device address digit
- b = space (blank)
- a = alarm number (1-4)
- s = sense (HI or LO)
- t = terminator character

Example Data:

16 ALARM 2 HI(cr)(lf) ...indicator #16 has a high alarm reading with limit #2 exceeded—each reading is terminated with a carriage return/line feed.

07 ALARM 1 LO(sp)(sp) ...indicator #7 has a low alarm reading with limit #1 exceeded—each reading is terminated with two spaces.

3.11 USING THE BCD OPTION

The BCD output option gives you BCD data of the indicator's display read-out. The option requires no programming; thus, no special BCD menu prompts are given with this option installed.

To use the BCD option, just plug it in and connect to your BCD processor. You will have to make a cable to interface the BCD output card to the external device. A mating connector for the BCD output card is provided for this purpose. Refer to 2.7.5 for details on installation and wiring.

All output lines, except for DATA READY, are tri-state controlled. The following summarizes operation of the BCD lines:

INPUT LINES:

TRI-STATE: Three active low inputs provide independent tri-state control of portions of the data. These inputs can be tied together for tri-state control of all data output lines at once. They can also be used selectively in conjunction with HOLD for data output in 8-bit bytes.

HOLD: This line, when low, holds the BCD data at its current value if the data is also valid (DATA READY high). If the data is not valid when HOLD goes low, the data will be held once the data is valid.

OUTPUT LINES:

DIGIT DATA: A single digit of data is represented by four lines with binary weighting of 8-4-2-1. A total of four digits of data (16 lines) is provided with 4-digit indicators. A total of five digits of data (20 lines) is provided with 5-digit indicators. Data output is positive true logic.

+ POLARITY: This line indicates polarity of the data: high for positive readings and low for negative readings.

OVERLOAD: This line, when high, indicates an input overload condition (overrange or open thermocouple).

DATA READY: This line, when high, indicates that valid data is present at the output lines.

3.12 USING THE IEEE-488 OPTION

3.12.1 Introduction

The IEE-488 option enables your indicator to be linked to other IEE-488 - also known as HP-IB or GPIB - compatible instruments, computers, and/or peripherals. With the IEEE-488 option, your indicator becomes a talker/listen-er; sending out measurement data and receiving programming commands over the IEEE-488 bus. This new communications option requires no program-ming; thus, no special menu prompts are given with this option installed.

As described by the IEEE-488 standard, the IEEE-488 option gives your indica-tor the following capabilities:

- SH1 — Complete Source Handshake capability
- AH1 — Complete Acceptor Handshake capability
- T5 — Basic talker, serial poll, talk only mode, unaddresses if MLA¹
- L4 — Basic listener, unaddresses if MTA²
- SR1 — Complete Service Request capability
- RL0 — No Remote/Local capability
- PP1 — PPC and PPE bus commands configure the Parallel Poll response
- DC1 — Complete Device Clear capability
- DT0 — No Device Trigger capability
- C0 — No Controller capability

¹MLA: My Listen Address

²MTA: My Talk Address

Before placing the IEEE-488 option in service, configure the option to your application as explained in the instructions in the next section.

3.12.2 Configuring the IEEE-488 Option

Configure the IEEE-488 option for your specific application by setting the option card's 8-pole DIP switch (S1). The indicator reads these switches at power on and after Device Clear (DCL) or Addressed Device Clear (ADC) commands. The switch assembly is on the circuit board just left of the IEEE-488 connector (accessible from the back of the indicator with rear panel removed). The switches and their function are shown below.

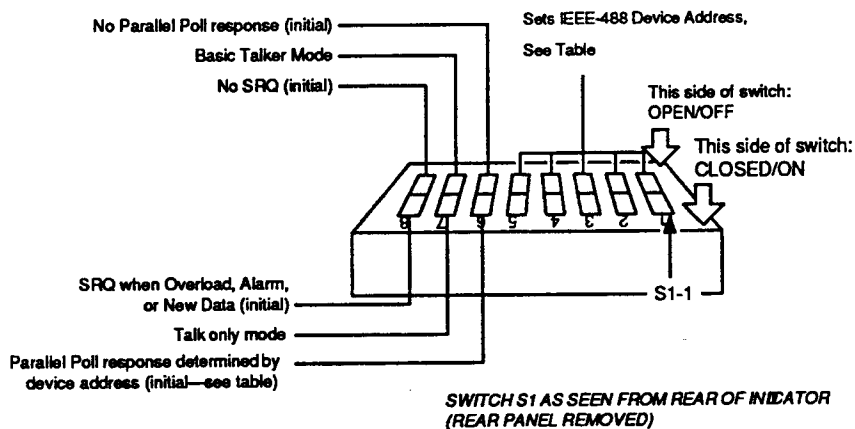

PARALLEL POLL CONFIGURATION TABLE

| Address Switch (3,2,1) Status: | Selects Bit: | To repond to parallel poll with: |
|--------------------------------|--------------|--|
| OFF, OFF, OFF | 0 | "0" if device address: 0-7, 16-23 (S1-4 OFF) OR "1" if device address: 8-15, 24-30 (S1-4 ON) |
| OFF, OFF, ON | 1 | |
| OFF, ON, OFF | 2 | |
| OFF, ON, ON | 3 | |
| ON, OFF, OFF | 4 | |
| ON, OFF, ON | 5 | |
| ON, ON, OFF | 6 | |
| ON, ON, ON | 7 | |

IEEE-488 OPTION, DEVICE ADDRESS TABLE

| DIP SWITCH S1 | | | | | Device Address | DIP SWITCH S1 | | | | | Device Address |
|---------------|-----|-----|-----|-----|----------------|---------------|-----|-----|-----|-----|----------------|
| 5 | 4 | 3 | 2 | 1 | | 5 | 4 | 3 | 2 | 1 | |
| OFF | OFF | OFF | OFF | OFF | 0 | ON | OFF | OFF | OFF | OFF | 16 |
| OFF | OFF | OFF | OFF | ON | 1 | ON | OFF | OFF | OFF | ON | 17 |
| OFF | OFF | OFF | ON | OFF | 2 | ON | OFF | OFF | ON | OFF | 18 |
| OFF | OFF | OFF | ON | ON | 3 | ON | OFF | OFF | ON | ON | 19 |
| OFF | OFF | ON | OFF | OFF | 4 | ON | OFF | ON | OFF | OFF | 20 |
| OFF | OFF | ON | OFF | ON | 5 | ON | OFF | ON | OFF | ON | 21 |
| OFF | OFF | ON | ON | OFF | 6 | ON | OFF | ON | ON | OFF | 22 |
| OFF | OFF | ON | ON | ON | 7 | ON | OFF | ON | ON | ON | 23 |
| OFF | ON | OFF | OFF | OFF | 8 | ON | ON | OFF | OFF | OFF | 24 |
| OFF | ON | OFF | OFF | ON | 9 | ON | ON | OFF | OFF | ON | 25 |
| OFF | ON | OFF | ON | OFF | 10 | ON | ON | OFF | ON | OFF | 26 |
| OFF | ON | OFF | ON | ON | 11 | ON | ON | OFF | ON | ON | 27 |
| OFF | ON | ON | OFF | OFF | 12 | ON | ON | ON | OFF | OFF | 28 |
| OFF | ON | ON | OFF | ON | 13 | ON | ON | ON | OFF | ON | 29 |
| OFF | ON | ON | ON | OFF | 14 | ON | ON | ON | ON | OFF | 30 |
| OFF | ON | ON | ON | ON | 15 | ON | ON | ON | ON | ON | INVALID |

Switches S1-1 through S1-5 set the indicator's device address within the IEEE-488 system. Set the switches as shown in the table above for the address you wish to assign to the indicator. Note that a particular address assignment creates a particular parallel poll response by the indicator when switch S1-6 is set CLOSED/ON.

Switch S1-6 selects the initial configuration of the parallel poll response. Regardless of the setting of S1-6, the parallel poll response can be changed by the PPC and PPU commands as defined in the IEEE-488 specification. Set S1-6 OPEN/OFF to disable (initially) a parallel poll response. Set S1-6 CLOSED/ON to enable a parallel poll response. The parallel poll response in this instance is determined by the device address. Set the device address as required for the desired parallel poll response as described in the "Parallel Poll Configuration Table."

Switch S1-7 selects the talk mode. Set S1-7 OPEN/OFF to place the indicator in the basic talker mode (talks only when spoken to). Set S1-7 CLOSED/OFF to place the indicator in the Talk Only mode (continuously sends data with every display update). Talk Only is ideal for use in systems that have listen only capabilities such as printers, simple data loggers, etc.

Switch S1-8 sets the initial condition of the SRQ mask. Regardless of the switch setting, the SRQ mask may be changed by the Mask message. Set S1-8 OPEN/OFF to prevent SRQ from being asserted for any event. Set S1-8 CLOSED/ON for SRQ to be asserted on each new display message.

3.12.3 IEEE-488 Data I/O Format

With the IEEE-488 option, information shown on your indicator's display is given over the IEEE-488 buss. The indicator can also be programmed via other IEEE-488 devices. This section describes the data from the indicator, and the commands that can be sent to the indicator over the IEEE-488 buss. Also dis-cussed is SRQ and Polling, and the effect of Device Clear commands.

Output Data Format

Indicator data, whether alphabetical or numerical, is sent over the IEEE-488 buss as a 10-byte ASCII string. For measurement data, the numeric value including sign and decimal point make up the first seven bytes. Engineering units make up the last three bytes. The last character of the 10-byte ASCII string is sent with the End or Identify (EOI) line asserted.

Input Data Format

Data given to the indicator (IEEE-488 option) is either a keyboard simulation or an SRQ mask message. The former controls the indicator in the same manner as manually pressing the indicator's front panel keys; the latter de-fines the condition(s) at which an SRQ is generated by the indicator.

ASCII characters represent the indicator's front panel keys as follows:

| | | |
|---|---|-------------------|
| P | = | PGM (Program) key |
| U | = | Up Arrow key |
| D | = | Down Arrow key |
| E | = | ENT (Enter) key |

With a particular sequence of *P*, *U*, *D*, or *E* characters, messages can be sent to program the indicator as if the front panel keys were being pressed. (In this case, a message is defined as an ASCII string whose last character is sent with EOI being asserted, followed by the UNL [unlisten] message.)

For example, to step through the menu, send *P* to put the indicator in the program mode. Then send *U*'s or *D*'s as required to step through the menu. Send another *P* to put the indicator back into the process mode. The indicator responds only to those combination of *P*, *U*, *D*, and *E* characters which make up valid key presses. Messages which make up an invalid key press (such as *PE*) are ignored.

The indicator can assert the Service Request (SR) line to alert the IEEE-488 controller of any or all indicator events (overload, alarms 1-4, data). As mentioned in the Configuration section, setting switch S1-8 Open/Off initially disables SRQ generation; setting switch S1-8 Closed/On initially enables SRQ generation for all events. With the SRQ mask message, you select the events for which an SRQ is desired.

The SRQ mask message is made up of two bytes: ASCII character "M" followed by a byte whose bits are flagged according to the event needing an SRQ assertion. This second byte is illustrated below:

Second Byte, SRQ Mask Message

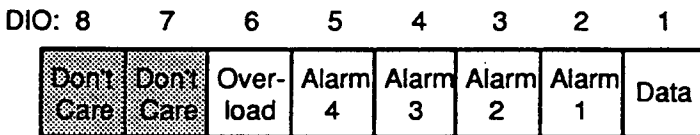

Set appropriate bit to "1" for SRQ.
Set appropriate bit to "0" for no SRQ.

For example, to produce an SRQ for overload and/or alarm 4 (highest priority alarm), the second byte of the SRQ mask message would be encoded with the bit pattern (in descending bit order): xx110000. Note that bits 7 and 8 are irrelevant to the SRQ mask message, second byte. Consult an ASCII table to translate your desired bit pattern for the SRQ mask into the appropriate ASCII character. Our example of xx110000 can be given as 0 (zero) or lower case p.

SRQ and Polling

Serial Poll. When the IEEE-488 controller conducts a serial poll, it reads the serial poll response byte from each device in the system, one at a time. The IEEE-488 option's serial poll response byte consists of one bit (bit 7) that reflects the state of the SRQ (that is, asserted or not asserted) and seven bits (bits 1-5 and 8) that reflect the indicator's status. The IEEE-488 option does not make use of bit 8, so it is always set to zero. The format of the IEEE-488 option's serial poll response byte is illustrated below.

The table which follows lists the six possible serial poll responses with the corresponding ASCII code and decimal equivalent. The serial poll responses are prioritized 1-6 with "new data" being lowest priority and "overload" being highest priority. The serial poll response always reflects the highest priority condition of the indicator.

Serial Poll Response Byte

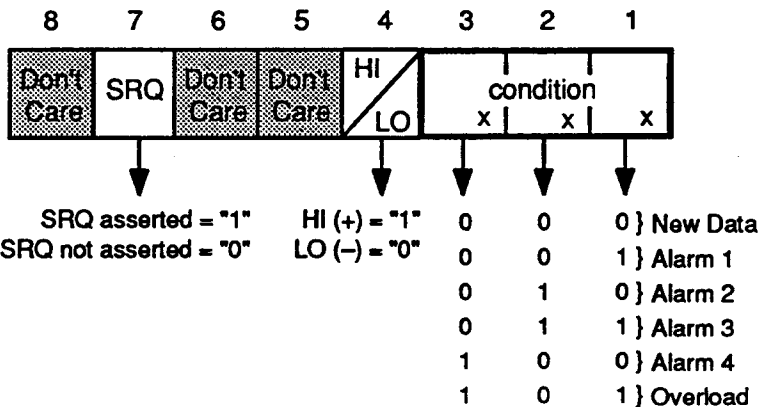

| PRIORITY | EVENT | SRQ ASSERTED | | SRQ NEGATED | |
|----------|----------|------------------------------------|----------|------------------------------------|----------|
| | | ASCII Character/ Decimal Equiv. | | ASCII Character/ Decimal Equiv. | |
| | | Low (-) | High (+) | Low (-) | High (+) |
| 1 | New Data | @ / 64 | — | NUL / 0 | — |
| 2 | Alarm 1 | A / 65 | I / 73 | SOH / 1 | HT / 9 |
| 3 | Alarm 2 | B / 66 | J / 74 | STX / 2 | LF / 10 |
| 4 | Alarm 3 | C / 67 | K / 75 | ETX / 3 | VT / 11 |
| 5 | Alarm 4 | D / 68 | L / 76 | EOT / 4 | FF / 12 |
| 6 | Overload | E / 69 | M / 77 | ENQ / 5 | CR / 13 |

Parallel Poll. The parallel poll response configuration (initial or otherwise) can be reprogrammed using the PPC and PPU commands described in the IEEE-488 specification. When the IEEE-488 option receives a PPU command, its parallel poll configuration is disabled which prevents a response from a parallel poll. The PPC command must be followed by a command from the secondary address command group. When the IEEE-488 option receives this two-byte command, it uses the bit pattern of the second byte to determine the configuration. If bit 5 is set, then the configuration is disabled. Other-wise, bit 4 selects the sense and bits 1-3 select the bit to respond on (see Parallel Poll Configuration table in 3.12.2).

When the parallel poll is active and the IEEE-488 option is enabled for parallel polls, the output is true on the assigned bus data I/O line if the sense of the parallel status message (the SRQ in our case) matches the sense bit pro-grammed from the last PPE command message. This means if the option is asserting the SRQ and the sense bit is 1, the option will assert a true value on its assigned data I/O line during a parallel poll. Or if the IEEE-488 option is not asserting the SRQ and the sense bit is 0, then the option again asserts a true value on its assigned data I/O line. Otherwise it pass-ively sends a false on its assigned data I/O line. The output of the assigned data I/O line in the parallel poll response has an XNOR logic function:

| SRQ | SENSE BIT (Bit 4, PPE) | OUTPUT OF ASSIGNED DATA I/O LINE * |
|-----|---------------------------|---------------------------------------|
| 0 | 0 | 1 |
| 0 | 1 | 0 |
| 1 | 0 | 0 |
| 1 | 1 | 1 |

* Parallel Poll Response

Device Clear and Addressed Device Clear. The IEEE-488 specification defines commands that can be used to reset an instrument via the IEEE-488 interface. These commands are Device Clear and Addressed Device Clear. Use these commands as required to reinitialize the hardware and software of the IEEE-488 option. Device clear and addressed device clear commands do not affect the operation of the indicator itself or any of its other options.

APPENDIX

General Specifications

Input Range Table

Outline Drawings

DP81/DP82 SERIES GENERAL SPECIFICATIONS

Resolution:

Please see input range table

Accuracy:

Please see input range table

Reference Operating**Conditions:**

$\pm 10\%$ line voltage, 25°C
 $\pm 2^{\circ}\text{C}$ ambient temperature,
 $< 80\%$ RH non-condensing

Repeatability:

± 1 digit

Stability with Ambient**Temperature:**

Zero $0.5\mu\text{V}/^{\circ}\text{C}$

Span 0.005% of rdg./ $^{\circ}\text{C}$

Reference Junction

From 0°C to 50°C :

0.018°F for:

J, K, T, E, N, C, G, D,

CGI, Fe Con, CuCon

thermocouples

0.03°F for:

R, S, B thermocouples

Stability with Time:**Zero:**

No measurable drift with time.

Span:

Thermocouple, RTD, thermistor ranges: $< 1^{\circ}$ per year.

Noise Rejection:

NMRR $\geq 60\text{dB}$ @ 50/60 Hz

± 1 Hz

CMRR $\geq 120\text{dB}$ @ 50/60 Hz

± 1 Hz

Input Impedance:**Thermocouples:**

$22\text{M}\Omega$ (with 20 nA of break detect current)

RTD's:

$V_{in\text{-}Hi}$ to $V_{in\text{-}Lo}$: $500\text{M}\Omega$

I1 to I2: $10\text{M}\Omega$

Thermistors:

I1 to $V_{in\text{-}Hi}$: $3.2\text{k}\Omega$

I1 to I2: $9.45\text{k}\Omega$

Voltage:

$> 10\text{M}\Omega$ to $500\text{M}\Omega$ depending on range.

Current: $< 15\mu\text{A}$

Overload Protection (CMV):**Power lead to ground:**

1500V dc or ac RMS

Input to ground:

270V dc or ac RMS

Across Inputs:

270V dc or ac RMS continuous

4-20 mA range: 80 mA

10-50 mA range: 200 mA

Ambient Operating Range:**Temperature:**

0 to 50°C

Relative Humidity:

0 to 90%, non-condensing

Storage Temperature:

-40 to 65°C

Input Connections:

Sensors: screw terminal blocks

Multi-input: quick disconnect terminal blocks

AC Power: quick connect plug.

DC Power: screw terminal blocks.

Display:

8-digit, 14-segment alphanumeric LED; 0.54" digit height.

Also includes one negative (-) LED at left of LED array.

Point Update Rate:

.5 seconds per reading

(1 second per reading for R, S, B, C, G, D, and CGI thermocouples)

DP81/DP82 SERIES GENERAL SPECIFICATIONS

Linearization:

100% digital, using variable length, second order polynomial segments.

Case Construction:

Metal, black anodized, extruded aluminum.

Reliability:

40,000 hours MTBF

Installation:

Panel Mounting from front, secured at sides by clamps.

Size:

Single-wide (Model DP81):

Case:

67mm H x 136mm W x 250mm D

Bezel:

72mm H x 142.5mm W

Panel Cutout:

68mm H x 138mm W

Double-wide (Model DP82):

Case:

67mm H x 272mm W x 250mm D

Bezel:

72mm H x 284mm W

Panel Cutout:

68mm H x 274mm W

Weight (without options):

Single-wide: 1800 grams

Double-wide: 2800 grams

Warranty:

1 year

Reference Junction:

Automatic, internal

Power:

Jumper selectable ac power:

90 to 132V, 48 to 400 Hz

190 to 262V, 48 to 400 Hz

8.0 W typical (without options)

Jumper selectable dc power

option: 9 to 16V/18 to 32V

INPUT RANGE TABLE

| <i>Range Designator on Display</i> | <i>Sensor Type</i> | <i>Range</i> | <i>Accuracy (all ± 1 ct.), includes maximum linearization error</i> |
|------------------------------------|---|--|--|
| J T/C | Iron-Constantan | -336.0°F to 2193.3°F -204.4°C to 1200.7°C 68.8 K to 1473.9 K | 0.5°F 0.3°C 0.3 K |
| K T/C | Chromel-Alumel | -299.9°F to 2503.5°F -184.4°C to 1373.1°C 88.8 K to 1646.3 K | 0.6°F 0.3°C 0.3 K |
| T T/C | Copper-Constantan | -373.2°F to 753.7°F -225.1°C to 400.9°C 48.1 K to 674.1 K | 0.4°F 0.2°C 0.2 K |
| E T/C | Chromel-Constantan | -358.6°F to 1835.2°F -217.0°C to 1001.8°C 56.2 K to 1275.0 K | 0.6°F 0.3°C 0.3 K |
| R T/C | Platinum/Platinum 13% Rhodium | 32.0°F to 3219.1°F 0.0°C to 1770.6°C 273.2 K to 2043.8 K | 1.2°F (above 79.0 °F) 0.7°C (above 26.0°C) 0.7 K (above 299.2 K) |
| S T/C | Platinum/Platinum 10% Rhodium | 32.0°F to 3216.7°F 0.0°C to 1769.3°C 273.2 K to 2042.5 K | 1.2°F (above 79.0 °F) 0.7°C (above 26.0 °C) 0.7 K (above 299.2 K) |
| B T/C | Platinum 30% Rhodium – Platinum 6% Rhodium | 899.5°F to 3309.6°F 481.9°C to 1820.9°C 755.1 K to 2094.1 K | 2.0°F 1.1°C 1.1 K |

continued...

| <i>Range Designator on Display</i> | <i>Sensor Type</i> | <i>Range</i> | <i>Accuracy (at ±1 ct.), in- cludes maxi- mum lineari- zation error</i> |
|--|--|---|---|
| N T/C | Nicrosil-Nisil | 32.0°F to 2301.5°F 0.0°C to 1260.8°C 273.2 K to 1534.0 K | 0.5°F 0.3°C 0.3 K |
| C T/C | Tungsten 5% Rhenium – Tungsten 26% Rhenium | -10.0°F to 4200.4°F -23.3°C to 2315.8°C 249.9 K to 2589.0 K | 1.1°F 0.6°C 0.6 K |
| G T/C | Tungsten – Tungsten 26% Rhenium | 295.0°F to 4206.0°F 146.1°C to 2318.9°C 419.3K to 2592.1 K | 1.1°F 0.6°C 0.6 K |
| D T/C | Tungsten 3% Rhenium – Tungsten 25% Rhenium | -8.4°F to 4203.8°F -22.4°C to 2317.7°C 250.8 K to 2590.9 K | 1.1°F 0.6°C 0.6 K |
| CGI T/C | Chromel – Gold .07% Atomic Iron | -460.1°F to 44.9°F -273.4 °C to 7.2°C 0.0 K to 280.4 K | 0.4°F 0.2°C 0.2 K |
| FeCon | Iron-Constantan (DIN) | -330.6°F to 1654.7°F -201.4°C to 910.5°C 71.8 K to 1174.7 K | 0.9°F 0.5°C 0.5 K |
| CuCon | Copper-Constantan (DIN) | -331.3°F to 1114.4°F -201.8°C to 601.3°C 71.4 K to 874.5 K | 0.9°F 0.5°C 0.5 K |
| PT100 385 | Platinum-100Ω @ 0°C 3- or 4-wire, alpha=.00385 DIN 43670 curve | -332.3°F to 1571.7°F -202.4°C to 855.4°C 70.8 K to 1128.6 K | 0.2°F 0.1°C 0.1 K |
| PT100 392 | Platinum-100Ω @ 0°C 3- or 4-wire, alpha=.00392 | -401.0°F to 1572.0°F -240.6°C to 855.4°C 32.6 K to 1128.6 K | 0.2°F 0.1°C 0.1 K |

continued...

INPUT RANGE TABLE

| <i>Range Designator on Display</i> | <i>Sensor Type</i> | <i>Range</i> | <i>Accuracy (all ± 1 ct.), includes maximum linearization error</i> |
|------------------------------------|-------------------------------------|--------------------------|--|
| PT200 392 | Platinum-200 Ω @ | -330.1°F to 1566.2°F | 0.2°F |
| | 0°C, 3- or 4-wire, | -201.2°C to 852.3°C | 0.1°C |
| | alpha=.00392 | 72.0 K to 1125.5 K | 0.1 K |
| PT1000 | Platinum-1000 Ω @ | -330.4°F to 1025.6°F | 0.2°F |
| | 0°C, 3- or 4-wire, | -204.4°C to 1200.7°C | 0.1°C |
| | alpha=.00375 HYCAL Ultra 7 curve | 68.8 K to 1473.9 K | 0.1 K |
| Cu10 | Copper-10 Ω @ 25°C | -337.2°F to 507.2°F | 0.8°F |
| | 3- or 4-wire | -205.1°C to 264.0°C | 0.4°C |
| | per Minco Table 16-9 | 68.1 K to 537.2 K | 0.4 K |
| Ni120 | Nickel-120 Ω @ 0°C | -112.9°F to 608.2°F | 0.4°F |
| | 3- or 4-wire | -80.5°C to 320.1°C | 0.2°C |
| | per Minco Table 7-120 | 192.7 K to 593.3 K | 0.2 K |
| YSI 400 | Thermistor, Omega | -40.48°F to 224.32°F | 0.2°F |
| | 400 Series, 2-wire | -40.27°C to 106.84°C | 0.1°C |
| | | 232.88 K to 379.99 K | 0.1 K |
| YSI 700 | Thermistor, Omega | 31.00°F to 213.00°F | 0.4°F |
| | 700 Series, 3-wire | -0.56°C to 100.56°C | 0.2°C |
| | | 272.59 K to 373.71 K | 0.2 K |
| 4-20 MA | 4-20 milliamps | -5.00% to 105.00% | .01% of rdg. |
| 10-50 MA | 10-50 milliamps | -5.00% to 105.00% | .01% of rdg. |
| 100MV | dc millivolts | -15.000mV to 99.999mV | .01% of rdg. |

continued...

INPUT RANGE TABLE

| <i>Range Designator on Display</i> | <i>Sensor Type</i> | <i>Range</i> | <i>Accuracy (all ± 1 ct.), includes maximum linearization error</i> |
|------------------------------------|--------------------|-----------------------|--|
| 1000 MV | dc millivolts | -150.00mV to 999.99mV | .01% of rdg. |
| 10V | dc volts | -1.5000V to 9.9999V | .01% of rdg. |
| 100V | dc volts | -15.000V to 99.999V | .01% of rdg. |

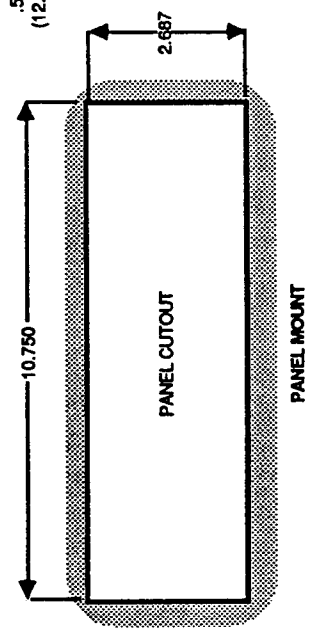
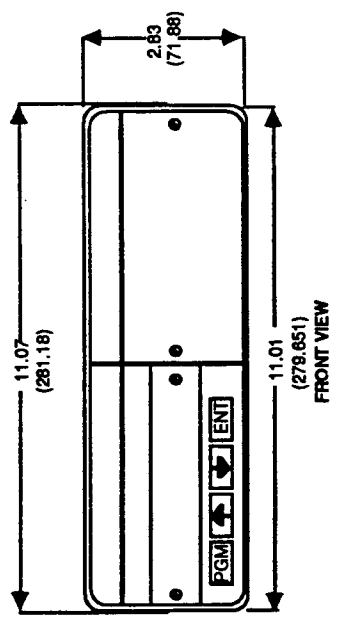
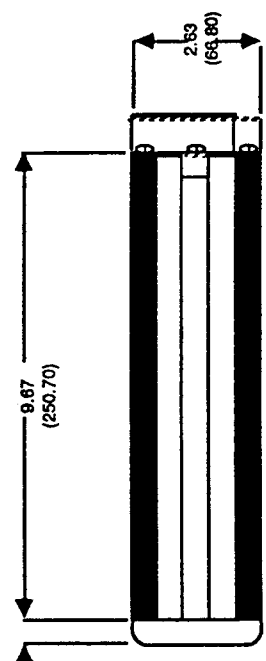
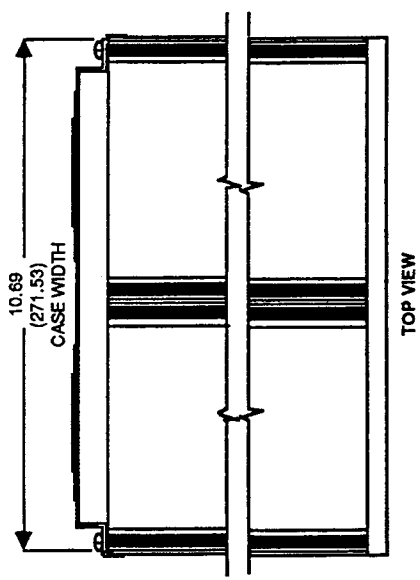

.50
(12.70)

