

1 YEAR
WARRANTY

Ω OMEGA® **User's Guide**



Shop online at
omega.comSM

e-mail: info@omega.com
For latest product manuals:
www.omegamanual.info



FMG70B Series
Magnetic Inductive Flow Sensor



www.omega.com info@omega.com

Servicing North America:

U.S.A.:

Omega Engineering, Inc., One Omega Drive, P.O. Box 4047
Stamford, CT 06907-0047 USA
Toll-Free: 1-800-826-6342 (USA & Canada only)
Customer Service: 1-800-622-2378 (USA & Canada only)
Engineering Service: 1-800-872-9436 (USA & Canada only)
Tel: (203) 359-1660 Fax: (203) 359-7700
e-mail: info@omega.com

For Other Locations Visit omega.com/worldwide

Table of contents	page
0 About this operating manual	4
1 Device description	5
1.1 Delivery, unpacking and accessories	5
1.2 Intended use.....	6
1.3 Exclusion of liability	6
2 Safety instructions	7
3 Construction and function	8
4 Installation of FMG70B	9
4.1 Installation instructions	9
4.2 Mounting.....	10
5 Electrical connection.....	11
5.1 Wirings	12
6 Commissioning and measuring mode	13
6.1 Commissioning.....	13
6.2 Switching on and off	13
6.3 Measuring mode.....	13
7 Maintenance and cleaning.....	15
7.1 Return shipment to the manufacturer	15
8 Disassembly and disposal	16
9 Technical data	17
9.1 Characteristics FMG70B	17
9.2 Materials table	18
9.3 Pressure drop.....	18
9.4 Temperature limits.....	19
9.5 Dimensions.....	20

Copyright notice:

The reproduction, distribution and utilization of this operating manual as well as the communication of its contents to others without express authorization is prohibited. Offenders will be held liable for the payment of damages. All rights reserved in the event of the grant of a patent, utility model or design.

0 About this operating manual

- The operating manual is aimed at specialists and semi-skilled personnel.
- Before each step, read through the relevant advice carefully and keep to the specified order.
- Thoroughly read and understand the information in the section "Safety instructions".

If you have any problems or questions, please contact your supplier or contact us directly at:



One Omega Drive, P.O. Box 4047
Stamford, CT 06907-0047
Tel: (203) 359-1660
e-mail: info@omega.com

Hazard signs and other symbols used:



WARNING! / CAUTION! Risk of injury!

This sign indicates dangers that cause personal injuries that can lead to health defects or cause considerable damage to property.



CAUTION! Electric current!

This sign indicates dangers which could arise from handling of electric current.



CAUTION! Material damage!

This sign indicates actions which could lead to possible damage to material or environmental damage.



ADHERE TO OPERATING MANUAL!



NOTICE!

This symbol indicates important notices, tips or information.



NO DOMESTIC WASTE!

The device must not be disposed of together with domestic waste.



Pay attention to and comply with information that is marked with this symbol.



Follow the specified instructions and steps. Adhere to the given order.



Check the specified points or notices.



Reference to another section, document or source.



Item.

1 Device description

The FMG70B series from Omega, is a non-contact flow sensor. The measurement is performed using magnetic induction and works without any moving parts.

The FMG70B is used for measuring or metering water and aqueous solutions. The compact design and independence from the intake and discharge sections allows the FMG70B to be used under a variety of conditions.

Versions *:

The FMG70B is available with inner diameters 0.39 in narrows to 0.16 in, 0.39 in and 0.79 in.

The versions can be configured differently (→ FMG70B data sheet).



Type plate:

The type plate sticker is located at the bottom side of the FMG70B.

It contains the most important data, the connection diagram and the arrow for the flow direction (Example → Fig.).

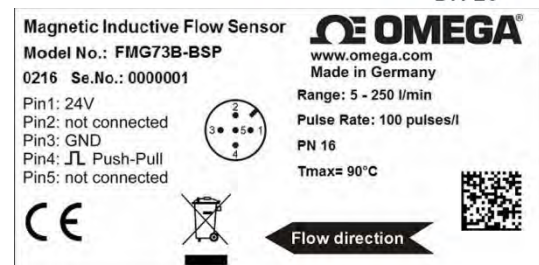

1.1 Delivery, unpacking and accessories

All units have been carefully checked for their operational reliability before shipment.

- Immediately after receipt, please check the outer packaging for damages or any signs of improper handling.
- Report any possible damages to the forwarder and your responsible sales representative. In such a case, state a description of the defect, the type and the serial number of the device.
Report any in-transit damage immediately. Damage reported at a later date shall not be recognized.

Unpacking:

- ↪ Carefully unpack the unit to prevent any damage.
- ↪ Check the completeness of the delivery based on the delivery note.

Scope of delivery:

- 1x FMG70B as ordered.
- 1x Operating manual.
- 1x Packing.

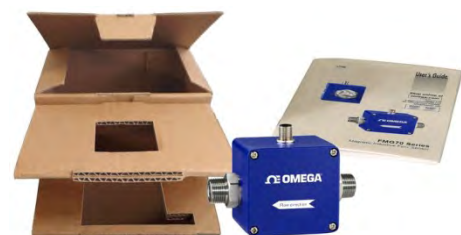

* Customised versions available on request.



IMPORTANT!

- ↪ Use the type plate to check if the delivered unit corresponds to your order.
- ↪ In particular, for devices with electrical components, check to see if the correct power supply voltage is specified.

Accessories:

- Connection cable with moulded M12x1 coupling socket.
- M12x1 coupling socket as component.

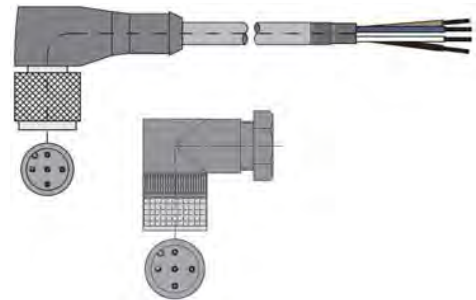

1.2 Intended use

The magnetic inductive flow sensor FMG70B must only be used for measuring and metering liquids with a minimum conductivity of 50 $\mu\text{S}/\text{cm}$.



WARNING! No safety component!

The magnetic inductive flow sensor of the series FMG70B is not safety components in accordance with Directive 2006-42-EC (Machine Directive).

- ↪ Never use the FMG70B as a safety component.

The operational safety of the device supplied is only guaranteed by intended use. The specified limits (\rightarrow § 9 "Technical data") may under no circumstances be exceeded.

Before installing the device, check that the wetted materials of the device are compatible with the media being used (\rightarrow § 9.2 "Materials table").

Measuring tube empty (or partially filled). / Conductivity too low.



The green LED may blink irregularly if the measuring tube of the FMG70B is empty or partially filled or if the conductivity of the fluid being used is too low. Random impulses will be present at the output, but they do not represent an actual flow.

- ↪ Ensure that the measuring tube of the FMG70B is always completely filled (\rightarrow § 4.1 "Installation instructions").
- ↪ Ensure that the conductivity of the fluid is at least 50 $\mu\text{S}/\text{cm}$.

1.3 Exclusion of liability

We accept no liability for any damage or malfunctions resulting from incorrect installation, inappropriate use of the device or failure to follow the instructions in this operating manual.

2 Safety instructions



Before you install the FMG70B, read through this operating manual carefully. If the instructions contained within it are not followed, in particular the safety guidelines, this could result in danger for people, the environment, and the device and the system it is connected to.

The FMG70B correspond to the state-of-the-art technology. This concerns the accuracy, the operating mode and the safe operation of the device.

In order to guarantee that the device operates safely, the operator must act competently and be conscious of safety issues.

Omega provides support for the use of its products either personally or via relevant literature. The customer verifies that our product is fit for purpose based on our technical information. The customer performs customer- and application-specific tests to ensure that the product is suitable for the intended use. With this verification all hazards and risks are transferred to our customers; our warranty is not valid.

Qualified personnel:

- ⚠ The personnel who are charged for the installation, operation and maintenance of the FMG70B must hold a relevant qualification. This can be based on training or relevant tuition.
The personnel must be aware of this operating manual and have access to it at all times.
- ⚠ The electrical connection should only be carried out by a fully qualified electrician.

General safety instructions:

- ⚠ In all work, the existing national regulations for accident prevention and safety in the workplace must be complied with. Any internal regulations of the operator must also be complied with, even if these are not mentioned in this manual.
- ⚠ Degree of protection according to EN 60529:
Please ensure that the ambient conditions at the site of use does not exceed the requirements for the stated protection rating (→ § 9 "Technical data").
- ⚠ Prevent freezing of the medium in the device with appropriate measures.
- ⚠ Only use the FMG70B if it is in perfect condition. Damaged or faulty devices must be checked without delay and, if necessary, replaced.
- ⚠ When fitting, connecting and removing the FMG70B use only suitable appropriate tools.
- ⚠ Do not remove or obliterate type plates or other markings on the device, as otherwise the warranty is rendered null and void.

Special safety instructions:

Warnings that are specifically relevant to individual operating procedures or activities can be found at the beginning of the relevant sections of this operating manual.

3 Construction and function

Components:

- ① Housing:
The housing consists of aluminum die casting and has the IP65 degree of protection.
- ② Electrical connection:
The electrical connection is made via 5-pin plug M12x1.
- ③ Operation / flow indicator LED.
- ④ Process connection:
The process connections are available in different sizes.
- ⑤ Type plate (sticker).

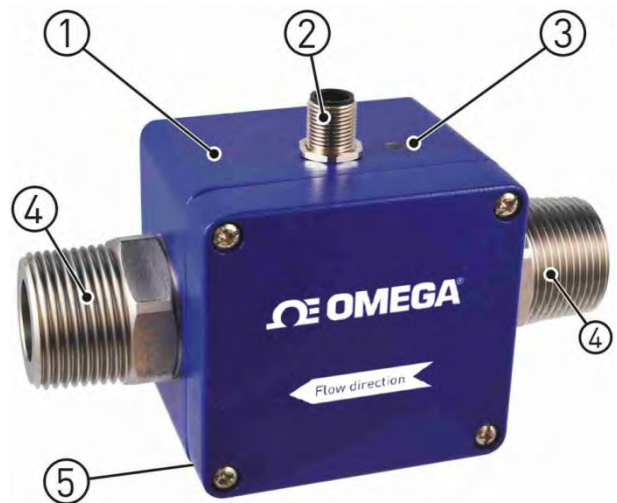

Construction:

The measuring tube with its earthing sleeves and electrodes passes through the housing and forms the external process connection of the FMG70B.

A magnetic field for the measurement process is generated inside the sensor housing, which also contains the sensor and signal conditioning circuitry.

The two stainless steel electrodes are located in the middle of the measuring tube between the earthing sleeves.

The FMG70B does not need any moving parts to make measurements. The inside of the measuring tube is completely open, allowing the fluid to flow unhindered through the measuring tube.

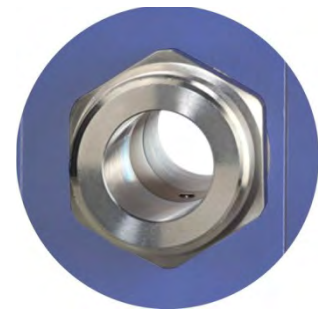

Function:

The magnetic inductive flow sensor operates in accordance with the principle of induction, i.e. a DC voltage is generated by the movement of a conductor in a magnetic field:

The measuring tube of the FMG70B is located in a magnetic field (B).

An electrically conductive liquid (Q) flows through the measuring tube. The positive and negative charge carriers are deflected in opposite directions.

A voltage perpendicular to the magnet field is generated and picked up by the two electrodes. The resulting induced voltage is proportional to the mean flow velocity of the liquid.

The electronics of the FMG70B converts the induced voltage to a flow-proportional frequency signal.

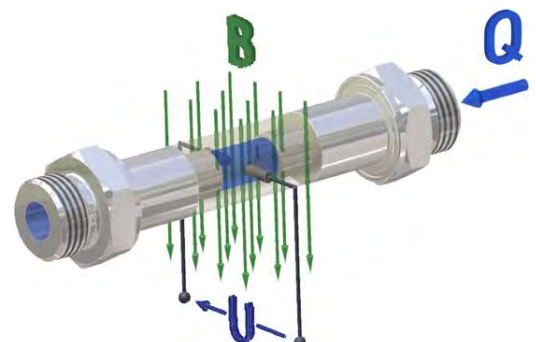

4 Installation of FMG70B

Before installing, check that

- the wetted materials of the device are suitable for the liquid being used (→ § 9.2 "Materials table").
- the equipment is switched off and is in a safe and de-energized state.
- the equipment is depressurized and has cooled down.



SUITABLE TOOLS:

- ↪ Use only suitable tools of the correct size.

4.1 Installation instructions



CAUTION! Risk of malfunction due to external magnetic fields!

Magnetic fields close to the device can cause malfunctions and should be avoided.

- ↪ Ensure that no external magnetic fields are present at the installation site of the FMG70B.

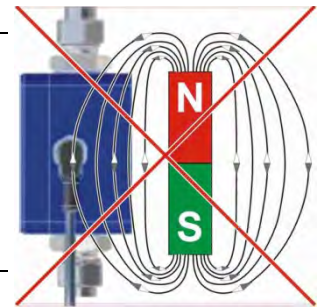

- The FMG70B can always be installed anywhere along the pipeline. Straight sections of piping are preferable, however.

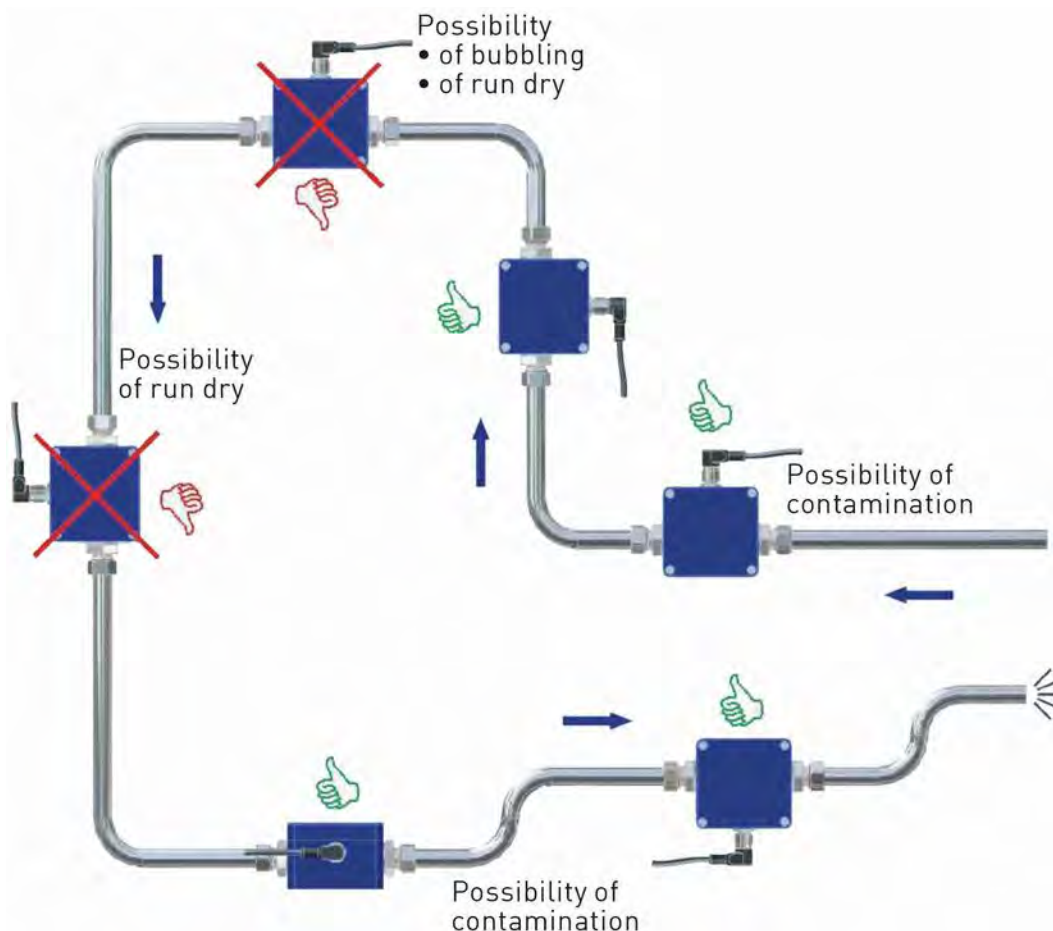

- Installation can occur in horizontal and vertical pipes. The flow sensor is only suitable for application in completely filled pipe systems.
- As a matter of principle magnetic inductive flow sensors are widely independent from the flow profile. An inlet section is not absolutely necessary. To reach a most highly accuracy of the measurement, you should use straight inlet and outlet sections according to the inner diameter. The inlet section has to be at least 10 x inner diameter; the outlet section 5 x inner diameter in order to achieve the specified accuracy.
- The inlet and outlet sections and gaskets must have the same or a slightly larger inside diameter than the measuring tube in order to achieve the specified accuracy.

4.2 Mounting

The FMG70B is installed directly into the pipeline. The compact design and light weight of the unit make wall-mounting unnecessary.



IMPORTANT NOTICES:

- Observe the flow direction indicated on the FMG70B.
 - Observe the mounting dimensions (→ § 9.5 "Dimensions").
- ↪ Select an appropriate location for installation (→ § 4.1 "Installation instructions"). To ensure the best possible measuring accuracy, a vertical installation position with increasing flow is preferable (no collecting of dirt deposits).
 - ↪ Wrap the FMG70B connections with 1 to 2 wraps of thread tape (e.g. Teflon® tape). Wrap tape in a clockwise direction, viewed from the end, leaving the first two threads uncovered.
 - ↪ Make sure the tape does not intrude into the flow path.
 - ↪ Attach the FMG70B with arrow pointed in the direction of flow.
 - ↪ The fittings should be screwed into FMG70B hand tight.

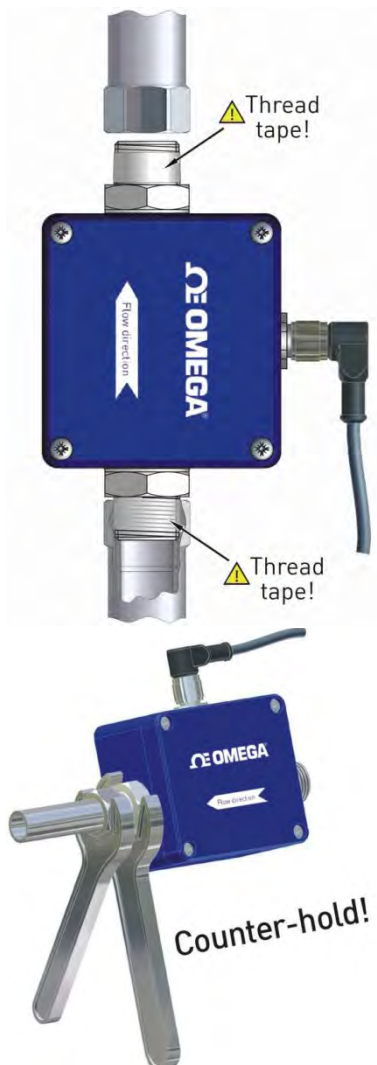

CAUTION! Material damage!

Do not use excessive force. The FMG70B can be damaged.



While tightening, counter the union nut on the hexagon of the process connection!

If you do not counter it, the FMG70B can be damaged!

Maximum Torque		
FMG71B - 1/2"	FMG72B - 1/2" • 3/4"	FMG73B - 1"
15 Nm	15 Nm	30 Nm

- ↪ Use two wrenches to tighten the FMG70B an additional 3/4 to 1 turn. When tightening, use a wrench (AF 1.063 or AF 1.338) to counter the process connection on the hexagon (flange) in place.

5 Electrical connection

The electrical connection of the FMG70B is via the 5-pin plug M12x1 at the top of the housing.

The wiring of the FMG70B depends on the ordered version. A distinction is made between frequency and analog output, as well as basic and optional wiring.



CAUTION! Electric current!

The electrical connection should only be carried out by a fully qualified electrician.

↪ De-energize the electrical system before connecting the FMG70B.



CAUTION! Material damage and fire hazard!

Exceeding the specified limits will cause damage to the electronics. Without current limiting, there is a fire hazard due to overheating of the device.

↪ Connect the FMG70B only to a power source with limited power.

Optional wirings:

Depending on the version, an analog output can be optionally connected.

Connecting cable:

Suitable connection cables with molded coupling socket are available in various lengths included in the range of Omega accessories. The shielding is already connected with the knurled nut.

IMPORTANT! Shielding required!



↪ Use only shielded connection cables.

↪ The shield of the connection cable should not be connected to earth.

We recommend to ground the pipes directly before and behind the FMG70B (→ Figure).

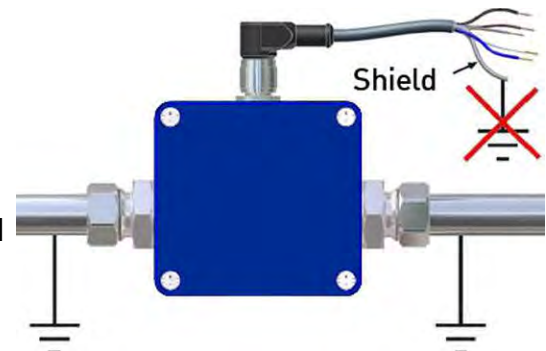

IMPORTANT NOTICE:



Pay attention to the temperature resistance of the connecting cable (→ § 9 "Technical data") at high media temperatures.

If the temperature resistance is smaller than the medium temperature, the cable may not be directly laid on the pipe.

Connection 5-pin plug M12x1:

↪ Screw the coupling socket of the connection cable to the plug of the FMG70B.

↪ Tighten the knurled nut of the coupling socket with a maximum torque of 1 Nm.

5.1 Wirings

Pinout:

The pinout differs according to the chosen configuration of the device.

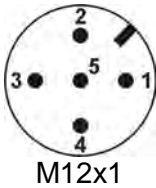

Possible pinout:

Pin 1: **+U_B**

Pin 2: n. c. (not connected) / Analog U/I

Pin 3: **GND**

Pin 4: Frequency

Pin 5: n. c. (not connected) / d. n. c. (do not connect)

↪ Connect the connecting cable according to your version and the pinout on the type plate.

Supply voltage:

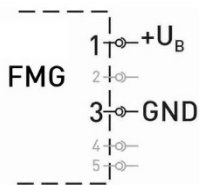

FMG70B with frequency output:

Push-Pull *1:

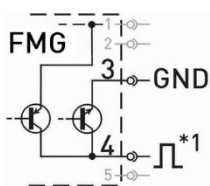

NPN Open Collector:

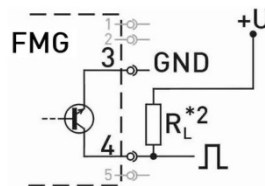

PNP Open Collector:

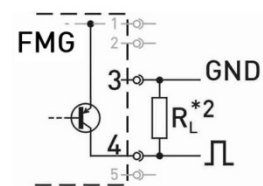

*1: Push-Pull switching outputs of several FMG70B may not be connected in parallel.

*2: Recommendation Pull-Up / Pull-Down resistance $R_L \sim 5 \text{ k}\Omega$

Use of frequency and analog output:

Push-Pull:

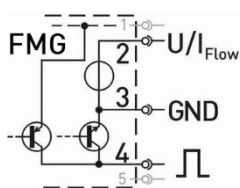

NPN Open Collector:

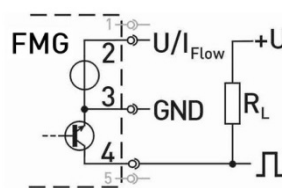

PNP Open Collector:

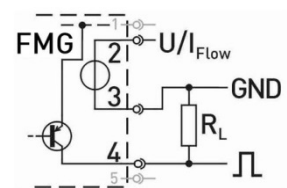

Recommendation for resistance $R_L \sim 5 \text{ k}\Omega$

6 Commissioning and measuring mode

Before switching on the FMG70B for the first time, please follow the instructions in the following section.

6.1 Commissioning

Check that

- the FMG70B has been installed correctly and that all screw connections are sealed.
- the electrical wiring has been connected properly.
- the measuring system is vented by flushing.

6.2 Switching on and off

The FMG70B has no switch and can therefore not be switched on and off independently. Switching on and off takes place via the connected supply voltage.

↪ Switch on the supply voltage.

The green LED lights up once for ~1 s. The FMG70B is ready and goes into measuring operation.



6.3 Measuring mode

In measuring mode, the green LED flashes proportional to the measured flow.



The human eye cannot detect the flashing any longer from a frequency of ~30 ... 40 Hz. In that case the green LED seems to be lit permanently.



The following subsections only apply to devices which have the correspondent functionality. ing subsections only apply to devices which have the correspondent functionality.

FMG70B with frequency output:

The FMG70B provides according to the version a flow proportional NPN, PNP or Push-Pull square wave signal.

The frequency of the pulse output changes according to the flow (→ Fig.).

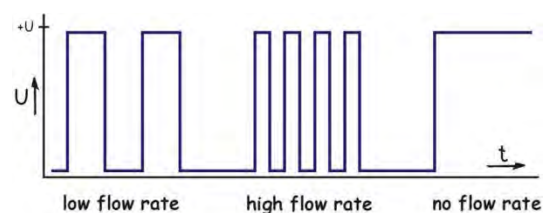

FMG70B with analog output:

According to the configuration of the FMG70B, the analog output provides a voltage or current signal.

This signal is proportional to the measured flow.

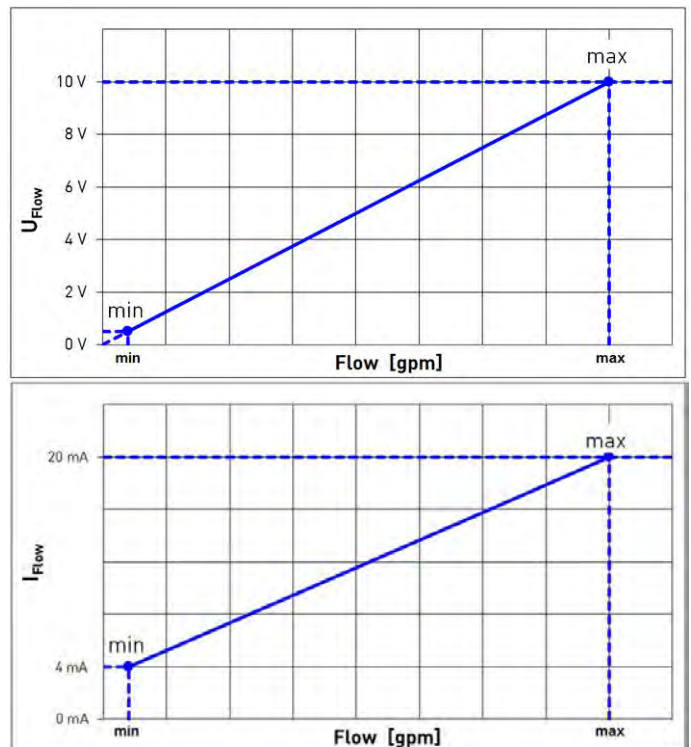

7 Maintenance and cleaning

Maintenance:

The FMG70B is maintenance-free and cannot be repaired by the user. In case of a defect, the device must be replaced or sent back the manufacturer for repair.



CAUTION! Material damage!

When opening the device, critical parts or components can be damage.

↳ Never open the device and perform any repair yourself.

Cleaning:

Clean the FMG70B with a dry or slightly damp lint-free cloth. Do not use sharp objects or aggressive agents for cleaning.

7.1 Return shipment to the manufacturer

Due to legal requirements placed on environmental protection and occupational safety and health and to maintain the health and safety of our employees, all units returned to Omega for repair must be free of toxins and hazardous substances. That also applies to cavities in the devices. If necessary, the customer must neutralize or purge the unit before return to Omega.

Costs incurred due to inadequate cleaning of the device and possible costs for disposal and/or personal injuries will be billed to the operating company.



WARNING! Risk of injury due to insufficient cleaning!

The operating company is responsible for all damages and harm of any kind, in particular physical injuries (e.g. caustic burns or toxic contaminations), decontamination measures, disposal etc. that can be attributed to insufficient cleaning of the measuring instrument.

↳ Please follow the instructions for sending in returns shown on page 23 of this manual.

The following measures must be taken before you send the unit to Omega for repair:

- ↳ Clean the device thoroughly. This is of extreme importance if the medium is hazardous to health, i.e. caustic, toxic, carcinogenic or radioactive etc.
- ↳ Remove all residues of the media and pay special attention to sealing grooves and slits.
- ↳ Attach a note describing the malfunction, state the application field and the chemical/physical properties of the media.
- ↳ Please specify a point of contact in case our service department has any questions.

8 Disassembly and disposal



CAUTION! Risk of injury!

Never remove the device from a plant in operation.

↪ Make sure that the plant is shut down professionally.

Before disassembly:

Prior to disassembly, ensure that

- the equipment is switched off and is in a safe and de-energized state.
- the equipment is depressurized and has cooled down.

Disassembly:

- ↪ Remove the electrical connectors.
- ↪ Remove the FMG70B using suitable tools.

Disposal:



NO HOUSEHOLD WASTE!

The FMG70B consists of various different materials. He must not be disposed of with household waste.

- ↪ Take the FMG70B to your local recycling plant

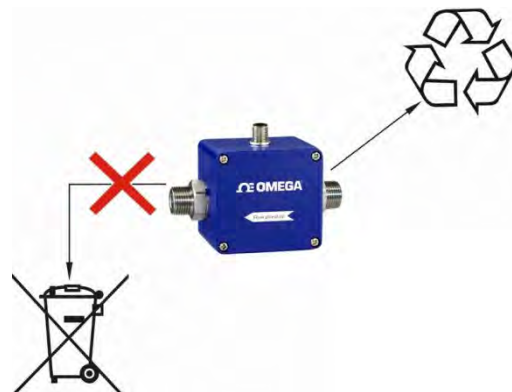

9 Technical data

The technical data of customized versions may differ from the data in these instructions. Please observe the information specified on the type plate.

9.1 Characteristics FMG70B

Type	FMG71B	FMG72B	FMG73B
Measurement device characteristics			
Measuring range	0.13...8 GPM	0.26...16 GPM	1.3...66 GPM
Accuracy *1 (Frequency output)	±1.5% of reading ±0.3% of full scale value		
Repeatability *1	1%		
Output signal starting from	~0.11 GPM	~0.24 GPM	~1.06 GPM
Response time (frequency / frequency + analog)	< 500 ms / < 800 ms		
Flow indication	LED green, flow proportional flashing		
Output signal characteristics			
Frequency output:			
Pulse rate [pulses/gal] - optional*2	2,000 4...7,500	1,000 4...3,700	250 4...750
Resolution [gal/pulse] - optional*2	0.0005 0.26...0.0001	0.001 0.26...0.0003	0.005 0.26...0.0013
Signal shape	Square wave signal • duty cycle 50:50 Push-Pull • NPN open collector (o.c.) • PNP o.c.		
Signal current	≤ 100 mA, current limited		
Analog output 4...20 mA (optional):			
Signal current corresponding flow of *3	0...5 GPM • 0...8 GPM	0...10 GPM • 0...16 GPM	0...50 GPM • 0...66 GPM
maximum load	250 Ω to GND		
Analog output 0...10 V (optional):			
Signal voltage corresponding flow of *3	0...5 GPM • 0...8 GPM	0...10 GPM • 0...16 GPM	0...50 GPM • 0...66 GPM
Electrical characteristics			
Supply voltage	24 V _{DC} ±10%		
Current consumption	≤ 150 mA		
Electrical connection	5-pin plug M12x1		
Degree of protection (EN 60529)	IP 65 (with attached coupling socket)		

*1 Test conditions: Water 73.4 °F at 150 ±100 µS/cm; Standard impulse rate.

*2 factory setting.

*3 other range on request.

Type	FMG71B	FMG72B	FMG73B
Process variables			
Medium to measure:	Water and others conductive liquids		
- Conductivity	> 50 $\mu\text{S/cm}$		
- Temperature	41...194 °F		
Ambient temperature	41... T_{max} °F (\rightarrow § 9.4)*		
Inner diameter	0.39 in narrows to 0.16 in	0.39 in	0.79 in
Nominal pressure	232 psi		
Process connection	½" NPT male thread	½" NPT male thread • ¾" NPT male thread	1" NPT male thread

* The maximum ambient temperature depends on the temperature of the medium and the wiring of the FMG70B.

9.2 Materials table

Component	Material	Wetted component
Housing	Aluminum die casting	
Measuring tube	PEEK-GF30	X
Electrodes	Stainless steel 1.4571	X
Gaskets	EPDM • FKM (optional)	X
Process connections	Stainless steel 1.4571	X

9.3 Pressure drop

FMG71B and FMG72B:

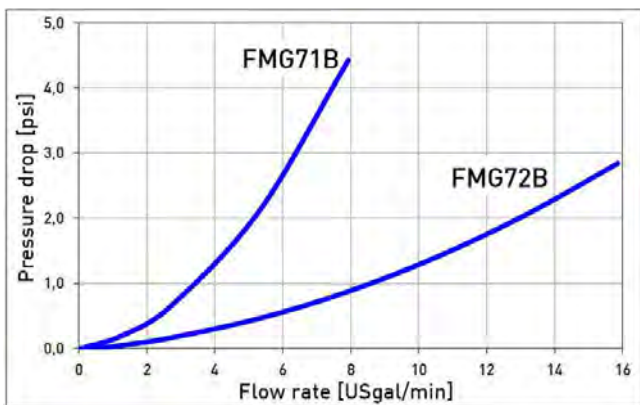

FMG73B:

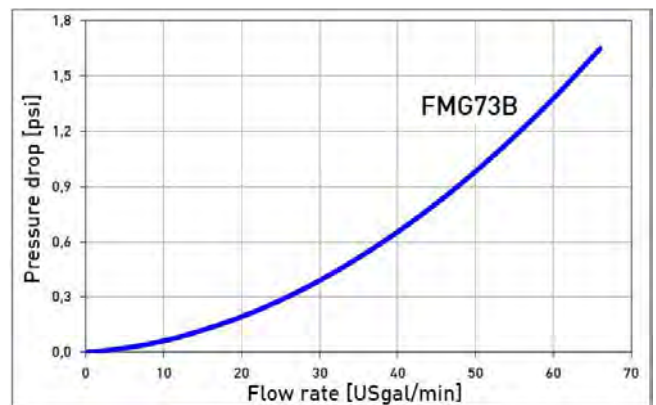

9.4 Temperature limits

The maximum ambient temperature depends on the medium temperature and the version of the FMG70B.

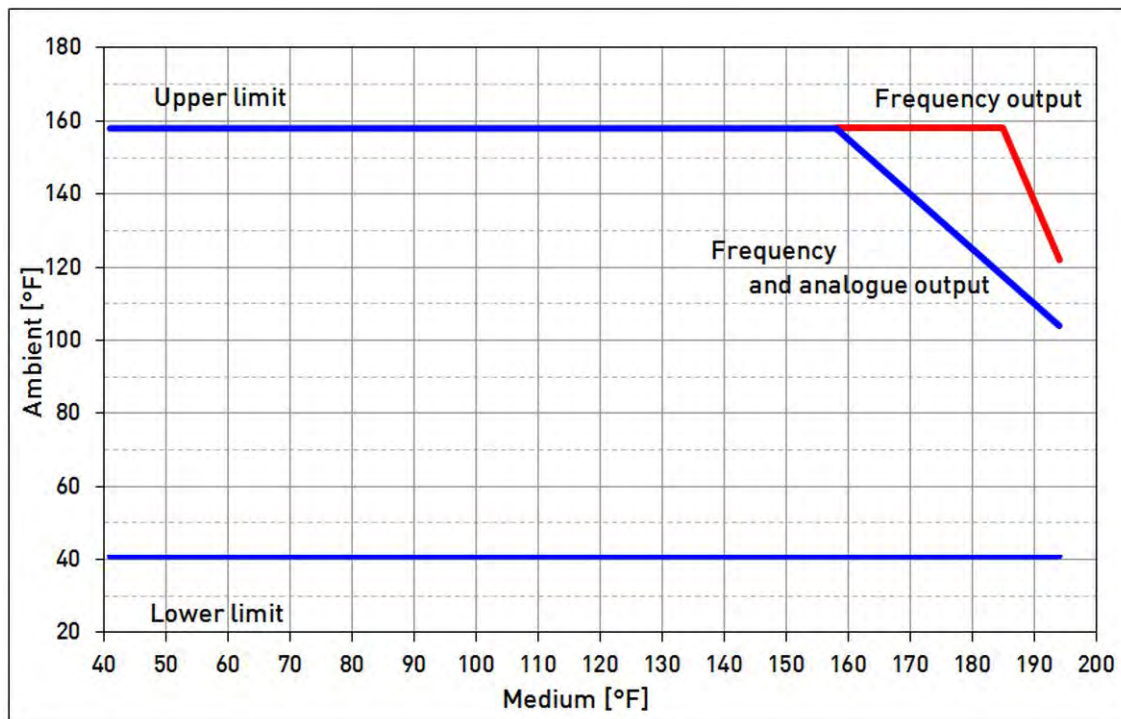

9.5 Dimensions

FMG71B and FMG72B:

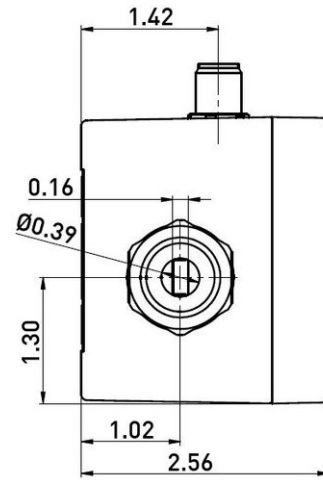
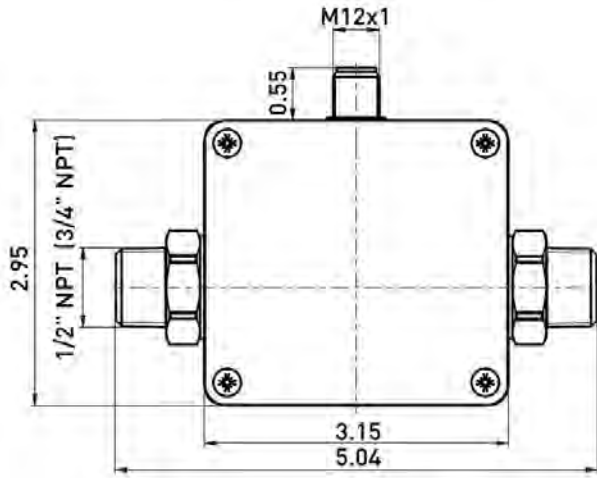

3/4" NPT only for FMG72B.

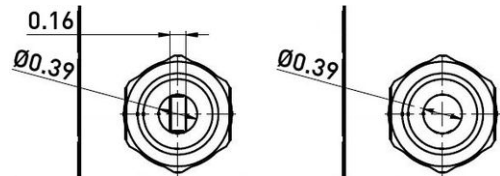
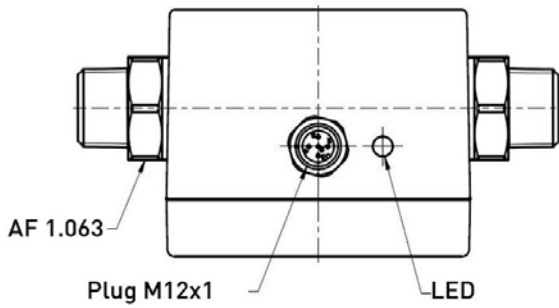

The cross section of the FMG72B does not taper to 0.16 in.

FMG73B:

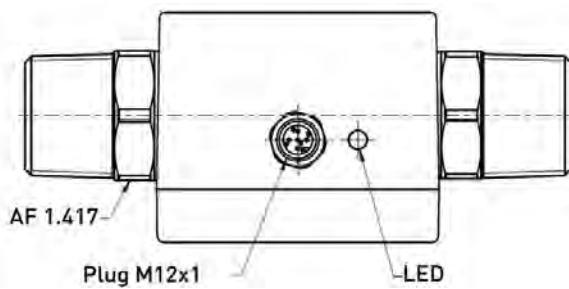
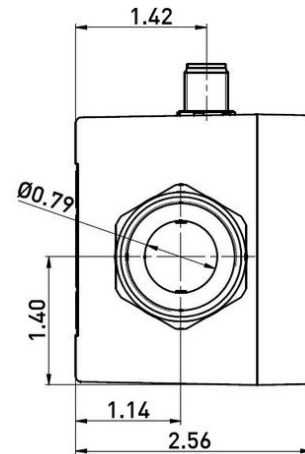
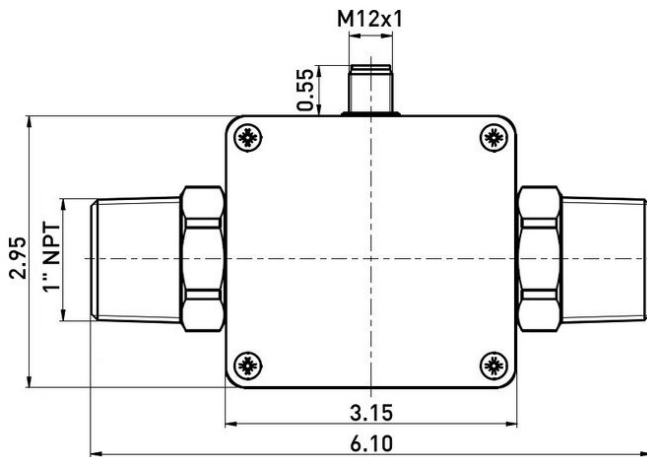

For your notes

For your notes

For your notes

WARRANTY/DISCLAIMER

OMEGA ENGINEERING, INC. warrants this unit to be free of defects in materials and workmanship for a period of **13 months** from date of purchase. OMEGA's WARRANTY adds an additional one (1) month grace period to the normal **one (1) year product warranty** to cover handling and shipping time. This ensures that OMEGA's customers receive maximum coverage on each product.

If the unit malfunctions, it must be returned to the factory for evaluation. OMEGA's Customer Service Department will issue an Authorized Return (AR) number immediately upon phone or written request. Upon examination by OMEGA, if the unit is found to be defective, it will be repaired or replaced at no charge. OMEGA's WARRANTY does not apply to defects resulting from any action of the purchaser, including but not limited to mishandling, improper interfacing, operation outside of design limits, improper repair, or unauthorized modification. This WARRANTY is VOID if the unit shows evidence of having been tampered with or shows evidence of having been damaged as a result of excessive corrosion; or current, heat, moisture or vibration; improper specification; misapplication; misuse or other operating conditions outside of OMEGA's control. Components in which wear is not warranted, include but are not limited to contact points, fuses, and triacs.

OMEGA is pleased to offer suggestions on the use of its various products. However, OMEGA neither assumes responsibility for any omissions or errors nor assumes liability for any damages that result from the use of its products in accordance with information provided by OMEGA, either verbal or written. OMEGA warrants only that the parts manufactured by it will be as specified and free of defects. OMEGA MAKES NO OTHER WARRANTIES OR REPRESENTATIONS OF ANY KIND WHATSOEVER, EXPRESS OR IMPLIED, EXCEPT THAT OF TITLE, AND ALL IMPLIED WARRANTIES INCLUDING ANY WARRANTY OF MERCHANTABILITY AND FITNESS FOR A PARTICULAR PURPOSE ARE HEREBY DISCLAIMED. LIMITATION OF LIABILITY: The remedies of purchaser set forth herein are exclusive, and the total liability of OMEGA with respect to this order, whether based on contract, warranty, negligence, indemnification, strict liability or otherwise, shall not exceed the purchase price of the component upon which liability is based. In no event shall OMEGA be liable for consequential, incidental or special damages.

CONDITIONS: Equipment sold by OMEGA is not intended to be used, nor shall it be used: (1) as a "Basic Component" under 10 CFR 21 (NRC), used in or with any nuclear installation or activity; or (2) in medical applications or used on humans. Should any Product(s) be used in or with any nuclear installation or activity, medical application, used on humans, or misused in any way, OMEGA assumes no responsibility as set forth in our basic WARRANTY/DISCLAIMER language, and, additionally, purchaser will indemnify OMEGA and hold OMEGA harmless from any liability or damage whatsoever arising out of the use of the Product(s) in such a manner.

RETURN REQUESTS/INQUIRIES

Direct all warranty and repair requests/inquiries to the OMEGA Customer Service Department. **BEFORE RETURNING ANY PRODUCT(S) TO OMEGA, PURCHASER MUST OBTAIN AN AUTHORIZED RETURN (AR) NUMBER FROM OMEGA'S CUSTOMER SERVICE DEPARTMENT (IN ORDER TO AVOID PROCESSING DELAYS).** The assigned AR number should then be marked on the outside of the return package and on any correspondence.

The purchaser is responsible for shipping charges, freight, insurance and proper packaging to prevent breakage in transit.

FOR **WARRANTY** RETURNS, please have the following information available BEFORE contacting OMEGA:

1. Purchase Order number under which the product was PURCHASED,
2. Model and serial number of the product under warranty, and
3. Repair instructions and/or specific problems relative to the product.

FOR **NON-WARRANTY** REPAIRS, consult OMEGA for current repair charges. Have the following information available BEFORE contacting OMEGA:

1. Purchase Order number to cover the COST of the repair,
2. Model and serial number of the product, and
3. Repair instructions and/or specific problems relative to the product.

OMEGA's policy is to make running changes, not model changes, whenever an improvement is possible. This affords our customers the latest in technology and engineering.

OMEGA is a registered trademark of OMEGA ENGINEERING, INC.

© Copyright 2015 OMEGA ENGINEERING, INC. All rights reserved. This document may not be copied, photocopied, reproduced, translated, or reduced to any electronic medium or machine-readable form, in whole or in part, without the prior written consent of OMEGA ENGINEERING, INC.

Where Do I Find Everything I Need for Process Measurement and Control?

OMEGA...Of Course!

Shop online at omega.comSM

TEMPERATURE

- Thermocouple, RTD & Thermistor Probes, Connectors, Panels & Assemblies
- Wire: Thermocouple, RTD & Thermistor
- Calibrators & Ice Point References
- Recorders, Controllers & Process Monitors
- Infrared Pyrometers

PRESSURE, STRAIN AND FORCE

- Transducers & Strain Gages
- Load Cells & Pressure Gages
- Displacement Transducers
- Instrumentation & Accessories

FLOW/LEVEL

- Rotameters, Gas Mass Flowmeters & Flow Computers
- Air Velocity Indicators
- Turbine/Paddlewheel Systems
- Totalizers & Batch Controllers

pH/CONDUCTIVITY

- pH Electrodes, Testers & Accessories
- Benchtop/Laboratory Meters
- Controllers, Calibrators, Simulators & Pumps
- Industrial pH & Conductivity Equipment

DATA ACQUISITION

- Data Acquisition & Engineering Software
- Communications-Based Acquisition Systems
- Plug-in Cards for Apple, IBM & Compatibles
- Datalogging Systems
- Recorders, Printers & Plotters

HEATERS

- Heating Cable
- Cartridge & Strip Heaters
- Immersion & Band Heaters
- Flexible Heaters
- Laboratory Heaters

ENVIRONMENTAL MONITORING AND CONTROL

- Metering & Control Instrumentation
- Refractometers
- Pumps & Tubing
- Air, Soil & Water Monitors
- Industrial Water & Wastewater Treatment
- pH, Conductivity & Dissolved Oxygen Instruments

M-5575/0416