

## MODEL CSPID – MODULAR CONTROLLER SERIES PID MODULES



- DEDICATED SINGLE AND DUAL PID MODULES FOR THE MODULAR CONTROLLER SERIES
- HOT-SWAPPABLE REPLACEMENT REDUCES DOWNTIME
- AUTO ADDRESSING MINIMIZES CONFIGURATION TIME
- FULLY ISOLATED DESIGN PROVIDES RELIABLE OPERATION
- PID CONTROL WITH REDUCED OVERSHOOT
- UNIVERSAL INPUTS ACCEPT TC, RTD, 0-10 V and 0/4-20 mA SIGNALS
- ON DEMAND AUTO-TUNING OF PID SETTINGS
- DC ANALOG OUTPUT (OPTIONAL, CSPID1 ONLY)
- HEATER CURRENT INPUT (OPTIONAL) ENSURES DETECTION OF HEATER CIRCUIT FAILURE
- WINDOWS<sup>®</sup> CONFIGURATION SOFTWARE

### GENERAL DESCRIPTION

The Model CSPID series modules are full featured PID controllers designed for use with the Modular Controller Series. The CSPID1 is a single loop controller, while the CSPID2 is a dual loop controller. The design of the system provides a true modular PID control platform for multi-zone control applications. The modules can accept a wide range of thermocouple, RTD, 0-10 V, 0/4-20 mA signals. With multiple discrete outputs, plus an optional analog output (CSPID1 only), the CSPID modules can perform virtually any combination of time-proportioning or linear control for heat, cool, or heat/cool applications. The discrete outputs may also be assigned to one of seven internal soft alarms. The CSPID1's optional linear output can be assigned to transmit virtually any internal variable.

The CSPID modules connect and communicate via a backplane connection to the CSMSTR Modular Controller Series Master. The CSMSTR, equipped with serial ports as well as an Ethernet port, allows the system to share data with PCs, PLCs, and SCADA systems. The Master supports any combination of up to 16 CS Series modules.

The CSPID modules are available with various discrete output combinations, including relays, open drain MOSFETs, and triac outputs. For applications requiring large loads to be controlled, several DIN rail mount relays are available.

The modules can operate in On/Off, P, PI, or PID control mode, and use an on-demand Auto-Tune that establishes the tuning constants. The PID constants may be fine-tuned through the serial or Ethernet interface. The modules employ a unique overshoot suppression feature, which allows the quickest response without excessive overshoot. The modules can also be operated in manual mode, providing the operator with direct control of the output.

Internal power management circuits allow the modules to be replaced while power is applied, which reduces downtime in the event of a relay failure. All configuration information is stored locally within each module, as well as in the Master, so replacement modules do not need to be configured.

The Modular Controller Series' high density packaging and DIN rail mounting saves time and panel space. The backplane connection provides power and communication to the module and snaps easily onto standard top hat (T) profile DIN rail.

### CONFIGURATION

The Modular Controller Series is configured with Windows<sup>®</sup> compatible Crimson<sup>®</sup> software. The software is an easy to use, graphical interface which provides a means of communication configuration, as well as commissioning and calibration of new systems.

### ALARMS

Each loop within the modules has seven internal "soft" alarms, which can be assigned to trigger any output. This includes four process alarms, two heater current, and one input fault alarm.

### ANALOG OUTPUT OPTION (CSPID1 ONLY)

The optional DC Analog Output (10 V or 20 mA) can be independently configured and scaled for control or re-transmission purposes.

### HEATER CURRENT MONITOR OPTION

The optional Heater Current Monitor input is useful for early warning of heater degradation, or heater circuit failure. The input connects to a current transformer with an output of 100 mA AC to ensure that proper heater current is present when the control output is on, and that little or no current is present when the output is off. This option provides immediate warning of a circuit short or open, instead of waiting for a high or low temperature shutdown alarm.

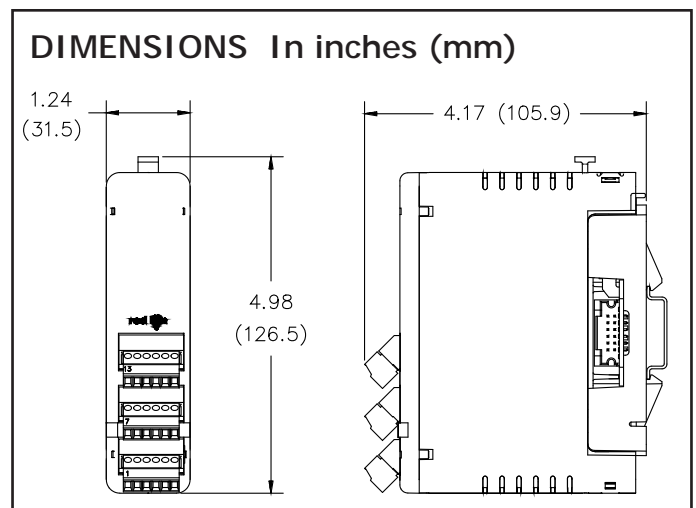
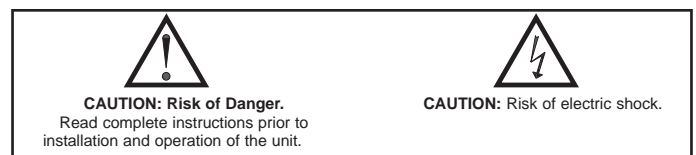

## SAFETY SUMMARY

All safety related regulations, local codes and instructions that appear in the manual or on equipment must be observed to ensure personal safety and to prevent damage to either the instrument or equipment connected to it. If equipment is used in a manner not specified by the manufacturer, the protection provided by the equipment may be impaired.

Do not use the controller to directly command motors, valves, or other actuators not equipped with safeguards. To do so can be potentially harmful to persons or equipment in the event of a fault to the controller. An independent and redundant temperature limit indicator with alarm outputs is strongly recommended.

## SPECIFICATIONS

1. **POWER:** Derived from system backplane. (CSPID1 draws 150 mA max. load on power input of MASTER, CSPID2 draws 125 mA max). Modules may be hot-swapped (Replaced while powered up).

2. **LEDs\*:**

**STS** - Status LED shows module condition

**OP1, OP2, OP3, OP4** - Indicate status of outputs 1, 2, 3, and 4

**ALM**, or **AL1** and **AL2** - Alarm LEDs are lit during any internal alarm condition

\* Default configuration.

3. **MEMORY:** Non-volatile memory retains all programmable parameters. MASTER also stores the parameters in order to reprogram modules that are replaced.

4. **INPUT:**

### GENERAL:

Sample Time: 67 msec (15 Hz)

Common Mode Rejection: >110 dB, 50/60 Hz

Normal Mode Rejection: >40 dB, 50/60 Hz

Temperature Coefficient: 0.01%/°C

Step Response Time: 200 msec typ., 250 msec max

### THERMOCOUPLE INPUTS:

Types: T, E, J, K, R, S, B, N, C

Input Impedance: 20 M  $\Omega$

Lead Resistance Effect: 0.25  $\mu$ V/ $\Omega$

Cold Junction Compensation: Less than  $\pm 1^\circ\text{C}$  typical ( $\pm 1.5^\circ\text{C}$  max) over 0 to 50 °C ambient temperature

Resolution: 0.1°

TYPE	MEASUREMENT RANGE	WIRE COLOR	
		ANSI	BS 1843
T	-200 to +400°C -328 to +752°F	(+) Blue (-) Red	(+) White (-) Blue
E	-200 to +730°C -328 to +1346°F	(+) Violet (-) Red	(+) Brown (-) Blue
J	-200 to +760°C -328 to +1400°F	(+) White (-) Red	(+) Yellow (-) Blue
K	-200 to +1250°C -328 to +2282°F	(+) Yellow (-) Red	(+) Brown (-) Blue
R	0 to +1768°C +32 to +3214°F	No Standard	(+) White (-) Blue
S	0 to +1768°C +32 to +3214°F	No Standard	(+) White (-) Blue
B	+149 to +1820°C +300 to +3308°F	No Standard	No Standard
N	-200 to +1300°C -328 to +2372°F	(+) Orange (-) Red	(+) Orange (-) Blue
C	0 to +2315°C +32 to +4199°F	No Standard	No Standard
W5/W6			
mV	-5 mV to 56 mV	N/A	N/A

### RTD INPUTS:

Type: 2 or 3 wire

Excitation: 150  $\mu$ A

Lead Resistance: 15  $\Omega$  Max

Resolution: 1 or 0.1°

TYPE	INPUT TYPE	RANGE
385	100 $\Omega$ platinum, Alpha = .00385	-200 to +600°C -328 to +1100°F
392	100 $\Omega$ platinum, Alpha = .003919	-200 to +600°C -328 to +1100°F
672	120 $\Omega$ nickel, Alpha = .00672	-80 to +215°C -112 to +419°F

## PROCESS INPUT:

INPUT RANGE	ACCURACY (18 TO 28 °C)	IMPEDANCE	MAX CONTINUOUS OVERLOAD	RESOLUTION
10 V	0.1% span	1 M Ohm	50 V	16 bit
20 mA	0.1% span	10 Ohm	100 mA	16 bit

5. **TEMPERATURE INDICATION ACCURACY:**  $\pm$  (0.3% of span, +1°C). Includes NIST conformity, cold junction effect, A/D conversion errors, temperature coefficient and linearization conformity at 23 °C after 20 minute warm up.

6. **ISOLATION LEVEL:** 500 Vrms @ 50/60 Hz for 1 minute between the following:

OP1

OP2

OP3

OP4

Linear Output (CSPID1 only)

Signal Inputs and HCM

CS Master Power Supply Input

7. **COMMUNICATIONS:** Provided by the CS Master

8. **A/D CONVERTER:** 16 bit resolution

9. **DISCRETE OUTPUTS:**

**CSPID1:** Outputs 1 and 2 available as Solid State NFET, Form A relay or Triac. Output 3 is a Form C relay.

**CSPID2:** Outputs 1 through 4 available as Form A relay, Solid State NFET, or Triac.

### Solid State Output:

Type: Switched DC, N Channel open drain MOSFET

Current Rating: 1 A max

VDS ON: 0.3 V @ 1 A

VDS MAX: 30 VDC

Offstate Leakage Current: 0.5 mA max

### Form A Relay Output:

Type: N.O.

Current Rating: 3 Amps @ 125 VAC

1/10 HP @ 125 VAC

Life Expectancy: 200,000 cycles at maximum load rating. (Decreasing load, increasing cycle time, and use of surge suppression such as RC snubbers increases life expectancy.)

### Form C Relay Output:

Type: SPDT

Current Rating: 5 Amps @ 125 VAC or 28 VDC (resistive load)

1/8 HP @ 125 VAC

Life Expectancy: 100,000 cycles at maximum load rating. (Decreasing load, increasing cycle time, and use of surge suppression such as RC snubbers increases life expectancy.)

### Triac: (CSPID1TA only)

Type: Optically isolated, zero-crossing detection

Rating: 120 VAC, Min: 20 VAC

Max Load Current: 1.0 A across Operating Temperature Range

Min Load Current: 5 mA

Offstate Leakage Current: 1 mA Max

Operating Frequency: 20 to 400 Hz

Protection: Internal Transient Suppression, Fused

### Triac: (CSPID2T0 and CSPID2TM only)

Type: Optically isolated, zero-crossing detection

Rating: 120 VAC, Min: 20 VAC

Max Load Current: 0.5A @ 25°C, 0.4A @ 50°C

Min Load Current: 5 mA

Offstate Leakage Current: 1 mA Max

Operating Frequency: 20 to 500 Hz

Protection: Internal Transient Suppression, Fused

10. **CONTROL MODES:**

Control: On/Off, P, PI, or PID

Output: Time proportioning or linear (CSPID1 only)

Cycle Time: Programmable from 0.0 to 60.0 sec

Auto-Tune: When selected, sets proportional band, integral time, derivative time values, and output dampening time

Probe Break Action: Programmable response

Sensor Fail Response: Upscale

**11. ALARMS:**

Modes:

- Manual
- Absolute High Acting
- Absolute Low Acting
- Deviation High Acting
- Deviation Low Acting
- Inside Band Acting
- Outside Band Acting

Reset Action: Programmable; automatic or latched

Standby Mode: Programmable; enable or disable

Hysteresis: Programmable

Sensor Fail Response: Upscale

**12. ANALOG DC OUTPUT (optional, CSPID1 only):**

Selectable/programmable for 0-10 VDC, 0-20 mA, or 4-20 mA

Resolution:

Voltage: 500  $\mu$ V

Current: 1  $\mu$ A

Accuracy:

0.1% of full scale (18 to 28 °C)

0.2% of full scale (0 to 50 °C)

Update Time: 0.0 to 60.0 sec

Compliance (for current output only): 500  $\Omega$  max.

Minimum load (voltage output only): 10 K $\Omega$  min.

Outputs are independently jumper selectable for either 10 V or 20 mA. The output range may be field calibrated to yield approximate 10% overrange and a small underrange (negative) signal.

**13. HEATER CURRENT MONITOR INPUT (optional):**

Type: Single phase, full wave monitoring of load currents

Input: 100 mA max. input for use with external current transformers

Input Resistance: 5  $\Omega$

Accuracy:  $\pm$ 3.0% full scale, 5 to 100% of range

Frequency: 50 to 400 Hz

Minimum output on time for break alarm: 350 msec

**14. ENVIRONMENTAL CONDITIONS:**

Operating Temperature Range: 0 to +50 °C

Storage Temperature Range: -40 to +85 °C

Operating and Storage Humidity: 85% max relative humidity, non-condensing, from 0 to +50°C

Vibration According to IEC 68-2-6: 10 to 150 Hz, 0.075 mm amplitude in X, Y, Z direction 1 g.

Shock According to IEC 68-2-27: Operational 25 g (10g relay), 11 msec in 3 directions.

Altitude: Up to 2000 meters

**15. CERTIFICATIONS AND COMPLIANCES:**

**SAFETY**

UL Listed, File # E302106, UL508, CSA C22.2 No. 14-M05

LISTED by Und. Lab. Inc. to U.S. and Canadian safety standards

IEC 61010-1, EN 61010-1: Safety requirements for electrical equipment for measurement, control, and laboratory use, Part 1.

**ELECTROMAGNETIC COMPATIBILITY**

Emissions and Immunity to EN 61326: 2006: Electrical Equipment for Measurement, Control and Laboratory use.

**Immunity to Industrial Locations:**

Electrostatic discharge	EN 61000-4-2	Criterion B 4 kV contact discharge 8 kV air discharge
Electromagnetic RF fields	EN 61000-4-3	Criterion B <sup>3</sup> 10 V/m
Fast transients (burst)	EN 61000-4-4	Criterion B power 2 kV I/O signal 1 kV
Surge	EN 61000-4-5	Criterion B I/O signal connected to power 2 kV power 1 kV L-L, 2 kV L-G signal 1 kV
RF conducted interference	EN 61000-4-6	Criterion A 3 V/rms
<b>Emissions:</b>		
Emissions	EN 55011	Class A

**Notes:**

1. *Criterion A: Normal operation within specified limits.*
2. *Criterion B: Temporary loss of performance from which the unit self-recovers.*
3. *The module's analog input and/or output signals may deviate during disturbance but self-recover when disturbance is removed.*
4. *Power supplied from backplane via Master Module.*

16. **CONSTRUCTION:** Case body is burgundy high impact plastic. Installation Category I, Pollution Degree 2.

17. **CONNECTIONS:** Removable wire clamp screw terminal blocks.

Wire Gage: 28-16 AWG terminal gage wire

Torque: 1.96-2.23 inch/lbs (0.22-0.25 N-m)

18. **MOUNTING:** Snaps on to standard DIN style top hat (T) profile mounting rails according to EN50022 -35 x 7.5 and -35 x 15.

19. **WEIGHT:** CSPID1: 7 oz (198.4 g)

CSPID2: 7 oz (198.4 g)

**BLOCK DIAGRAM**

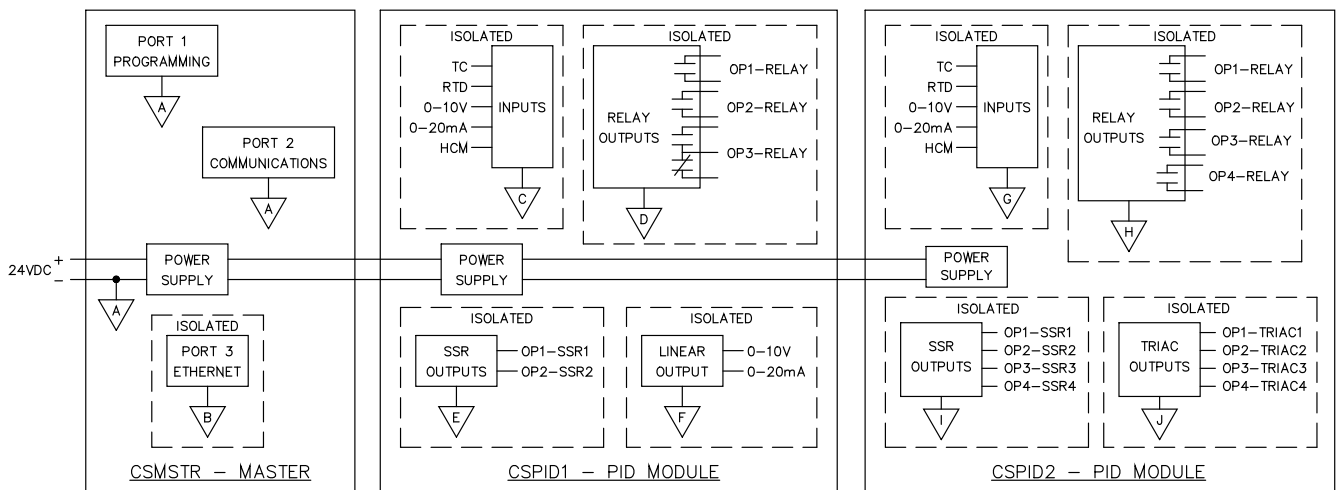

# EMC INSTALLATION GUIDELINES

Although Red Lion Controls Products are designed with a high degree of immunity to Electromagnetic Interference (EMI), proper installation and wiring methods must be followed to ensure compatibility in each application. The type of the electrical noise, source or coupling method into a unit may be different for various installations. Cable length, routing, and shield termination are very important and can mean the difference between a successful or troublesome installation. Listed are some EMI guidelines for a successful installation in an industrial environment.

1. A unit should be mounted in a metal enclosure, which is properly connected to protective earth.
  - a. The mounting clip that connects to the DIN rail should have the DIN rail connected to protective earth.
2. Use shielded (screened) cables for all Signal and Control inputs. The shield (screen) pigtail connection should be made as short as possible. The connection point for the shield depends somewhat upon the application. Listed below are the recommended methods of connecting the shield, in order of their effectiveness.
  - a. Connect the shield to earth ground (protective earth) at one end where the unit is mounted.
  - b. Connect the shield to earth ground at both ends of the cable, usually when the noise source frequency is over 1 MHz.
  - c. Connect the shield to common of the module and leave the other end of the shield unconnected and insulated from earth ground.
3. Never run Signal or Control cables in the same conduit or raceway with AC power lines, conductors feeding motors, solenoids, SCR controls, and heaters, etc. The cables should be run through metal conduit that is properly grounded. This is especially useful in applications where cable runs are long and portable two-way radios are used in close proximity or if the installation is near a commercial radio transmitter. Also, Signal or Control cables within an enclosure should be routed as far away as possible from contactors, control relays, transformers, and other noisy components.
4. Long cable runs are more susceptible to EMI pickup than short cable runs. Therefore, keep cable runs as short as possible.

5. In extremely high EMI environments, the use of external EMI suppression devices such as Ferrite Suppression Cores for signal and control cables is effective. The following EMI suppression devices (or equivalent) are recommended:
  - Fair-Rite part number 0443167251 (RLC part number FCOR0000)
  - TDK part number ZCAT3035-1330A
  - Steward part number 28B2029-0A0

6. To protect relay contacts that control inductive loads and to minimize radiated and conducted noise (EMI), some type of contact protection network is normally installed across the load, the contacts or both. The most effective location is across the load.

a. Using a snubber, which is a resistor-capacitor (RC) network or metal oxide varistor (MOV) across an AC inductive load is very effective at reducing EMI and increasing relay contact life.

b. If a DC inductive load (such as a DC relay coil) is controlled by a transistor switch, care must be taken not to exceed the breakdown voltage of the transistor when the load is switched. One of the most effective ways is to place a diode across the inductive load. Most RLC products with solid state outputs have internal zener diode protection. However external diode protection at the load is always a good design practice to limit EMI. Although the use of a snubber or varistor could be used.

RLC part numbers: Snubber SNUB0000

Varistor ILS11500 or ILS23000

*Note: Reference manufacturer's instructions when installing any EMI suppression device.*

7. Also care should be taken when connecting input and output devices to the instrument. When a separate input and output common is provided, they should not be mixed. Therefore a sensor common should NOT be connected to an output common. This would cause EMI on the sensitive input common, which could effect the instruments, operation.

Visit RLC's web site at [www.redlion.net](http://www.redlion.net) for more information on EMI guidelines, Safety and CE issues as they relate to Red Lion Controls products.

## HARDWARE

### CSPID1 ONLY ANALOG OUTPUT OPTION

Select either Voltage or Current output by placing the output jumpers in the appropriate location. The output jumpers are located on the side of the CSPID1 module.

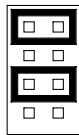

Voltage

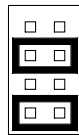

Current

### CSPID2 ONLY INPUT JUMPERS

Select the desired input type for each channel by positioning the jumper appropriately. For thermocouple inputs, the jumper position can be ignored.

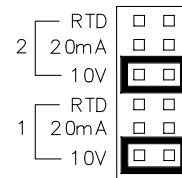

## INSTALLATION

### SEPARATE BASE FROM MODULE

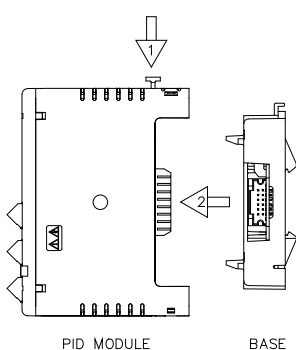

### ATTACH THE MODULE BASE TO THE DIN RAIL

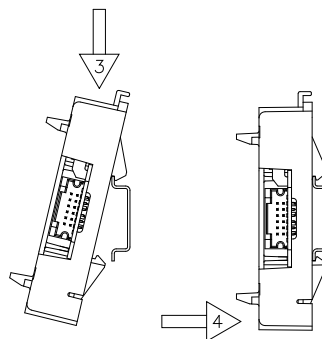

### ATTACH MODULE TO BASE

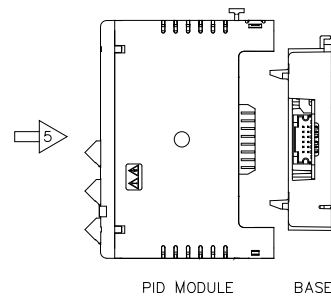

# WIRING

## WIRING CONNECTIONS

All conductors should meet voltage and current ratings for each terminal. Also, cabling should conform to appropriate standards of good installation, local codes and regulations. When wiring the module, use the numbers on the label to identify the position number with the proper function. Strip the wire, leaving approximately 1/4" (6 mm) of bare wire exposed. Insert the wire into the terminal, and tighten.

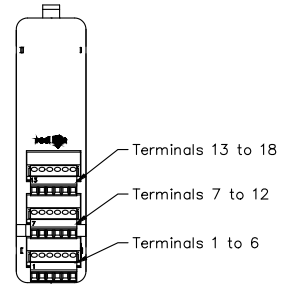

## CSPID1 INPUT CONNECTIONS

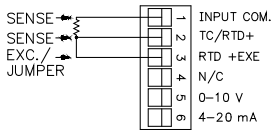

**RTD**

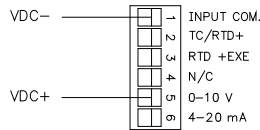

**Voltage**

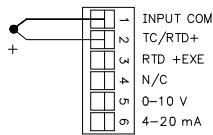

**Thermocouple and Millivolt**

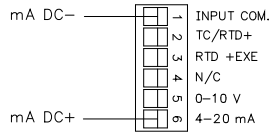

**Current**

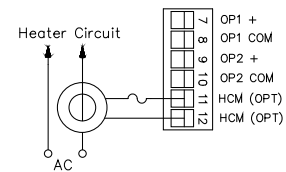

**Heater Current Monitor**

## CSPID2 INPUT CONNECTIONS

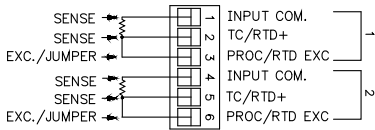

**RTD**

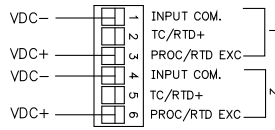

**Voltage**

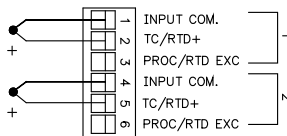

**Thermocouple and Millivolt**

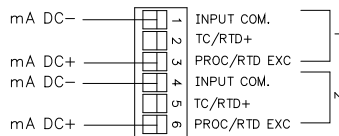

**Current**

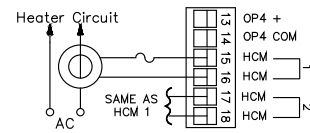

**Heater Current Monitor**

## CSPID1 OUTPUT CONNECTIONS

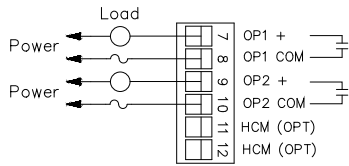

**Outputs 1 and 2 - Relay Version**

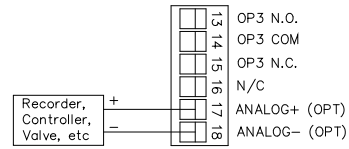

**Analog Output**

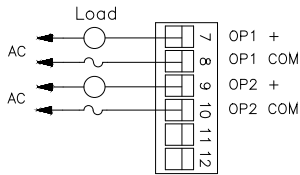

**Outputs 1 and 2 - Triac Version**

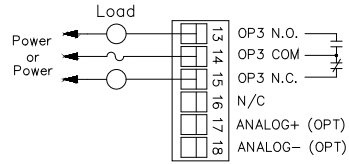

**Output 3**

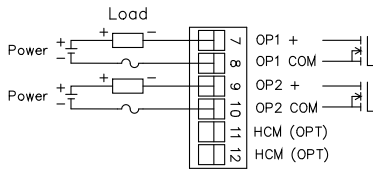

**Outputs 1 and 2 - Solid State Version**

## CSPID2 OUTPUT CONNECTIONS

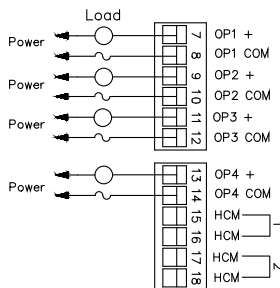

**Outputs 1- 4 - Relay Version**

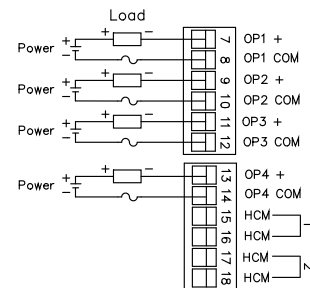

**Outputs 1- 4 - Solid State Version**

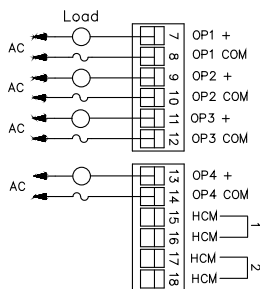

**Outputs 1- 4 - Triac Version**

## LEDS

### STS – STATUS LED

The Status LED is a dual color LED that provides information regarding the state of the module. This includes indication of the various stages of the start-up routine (power-up), as well as any errors that may occur.

#### Startup Routine

Rapidly Flashing Red	Module is currently running the boot loader and/or being flash upgraded by Crimson. This occurs for four seconds during a power up.
Steady Red	Module switching to configuration.
Green	Module performing normally.

### FIRMWARE UPGRADE

The module's firmware is stored in flash memory to prevent software/hardware conflicts, and so that software features may be added in the future.

During a download, Crimson compares its own library of firmware files with those stored in the Master module. If they do not match, Crimson will download the necessary files. The Master then checks to make sure that the I/O modules contain the same firmware. If they contain a different revision, the Master will automatically copy those files into the module's flash memory. During this process, the module LEDs will flash rapidly, starting with the top row, and progressing through the remaining rows until the process is complete.

### Error States

Solid Red	Module not controlling, and not communicating.
Green/Pulsing Red	Module is controlling properly, but has lost communication with the Master.

### OP1, OP2, OP3, OP4\* – OUTPUT STATUS LED

The OP1, OP2, OP3, and OP4\* LEDs are factory configured to indicate the status of the outputs. The LEDs turn on when the output is active.

These LEDs may be remapped to various other module properties.

\*CSPID2 only

### ALM OR AL1 & AL2 – ALARM LED

The Alarm LEDs are factory configured to indicate the presence of an alarm. Whenever one of the seven alarms is active, the LED turns on.

These LEDs may be remapped to various other module properties.

## CONFIGURATION

Programming is done via Crimson® software, a Windows® compatible configuration interface. Please see the Crimson manual for more information.

## ORDERING INFORMATION

TYPE	MODEL NO.	DESCRIPTION	PART NUMBER
Master Module	CSMSTR	Modular Controller Master, Multi Comms ports and Ethernet	CSMSTRV2
		Modular Controller Master with multiple protocol converter, Ethernet and expansion slot	CSMSTRLE
		Modular Controller Master with multiple protocol converter, data logger, web server with Virtual HMI up to QVGA (320 x 240) size and expansion slot.	CSMSTRSX
		Modular Controller Master with multiple protocol converter, data logger, web server with Virtual HMI up to VGA (640 x 480) size and expansion slot with increased SDRAM	CSMSTRGT
PID Control Modules	CSPID1 <sup>1</sup>	Single Loop Module, Relay Outputs	CSPID1R0
		Single Loop Module, Relay Outputs, Analog Output	CSPID1RA
		Single Loop Module, Relay Outputs, Heater Current Input	CSPID1RM
		Single Loop Module, Solid State Outputs	CSPID1S0
		Single Loop Module, Solid State Outputs, Analog Output	CSPID1SA
		Single Loop Module, Solid State Outputs, Heater Current Input	CSPID1SM
		Single Loop Module, Triac Outputs, Analog Output	CSPID1TA
	CSPID2	Dual Loop Module, Relay Outputs	CSPID2R0
		Dual Loop Module, Relay Outputs, Heater Current Input	CSPID2RM
		Dual Loop Module, Solid State Outputs	CSPID2S0
		Dual Loop Module, Solid State Outputs, Heater Current Input	CSPID2SM
		Dual Loop Module, Triac Outputs	CSPID2T0
		Dual Loop Module, Triac Outputs, Heater Current Input	CSPID2TM
		Communications Cables (10 feet)	CBL
Communications Cables <sup>1</sup>	CBLxxxx		
Software		Crimson® Programming Software <sup>2</sup>	SFCRM
		Crimson® Programming Software, Manual, and Download Cable	SFCRK
Accessories		Rail Stops (Qty 2)	RSRSTP00
		Replacement Base	CSBASE00
		Replacement Termination Plug	CSTERM00

<sup>1</sup> Visit [www.redlion.net](http://www.redlion.net) for a complete list of PID modules, data acquisition modules, communications drivers and cables.

<sup>2</sup> Free at [www.redlion.net](http://www.redlion.net)



**Re-Order from**   
**Omegamation™**  
**1-888-55-66342**  
**1-888-55-OMEGA**  
**omegamation.com**

#### LIMITED WARRANTY

The Company warrants the products it manufactures against defects in materials and workmanship for a period limited to two years from the date of shipment, provided the products have been stored, handled, installed, and used under proper conditions. The Company's liability under this limited warranty shall extend only to the repair or replacement of a defective product, at The Company's option. The Company disclaims all liability for any affirmation, promise or representation with respect to the products.

The customer agrees to hold Red Lion Controls harmless from, defend, and indemnify RLC against damages, claims, and expenses arising out of subsequent sales of RLC products or products containing components manufactured by RLC and based upon personal injuries, deaths, property damage, lost profits, and other matters which Buyer, its employees, or sub-contractors are or may be to any extent liable, including without limitation penalties imposed by the Consumer Product Safety Act (P.L. 92-573) and liability imposed upon any person pursuant to the Magnuson-Moss Warranty Act (P.L. 93-637), as now in effect or as amended hereafter.

No warranties expressed or implied are created with respect to The Company's products except those expressly contained herein. The Customer acknowledges the disclaimers and limitations contained herein and relies on no other warranties or affirmations.

Red Lion Controls  
Headquarters  
20 Willow Springs Circle  
York PA 17406  
Tel +1 (717) 767-6511  
Fax +1 (717) 764-0839

Red Lion Controls  
Europe  
Printerweg 10  
NL - 3821 AD Amersfoort  
Tel +31 (0) 334 723 225  
Fax +31 (0) 334 893 793

Red Lion Controls  
India  
54, Vishvas Tenement  
GST Road, New Ranip,  
Ahmedabad-382480 Gujarat, India  
Tel +91 987 954 0503  
Fax +91 79 275 31 350

Red Lion Controls  
China  
Unit 101, XinAn Plaza  
Building 13, No.99 Tianzhou Road  
ShangHai, P.R. China 200223  
Tel +86 21 6113-3688  
Fax +86 21 6113-3683